



MODEL

104

PARTS BOOK

5227



8134

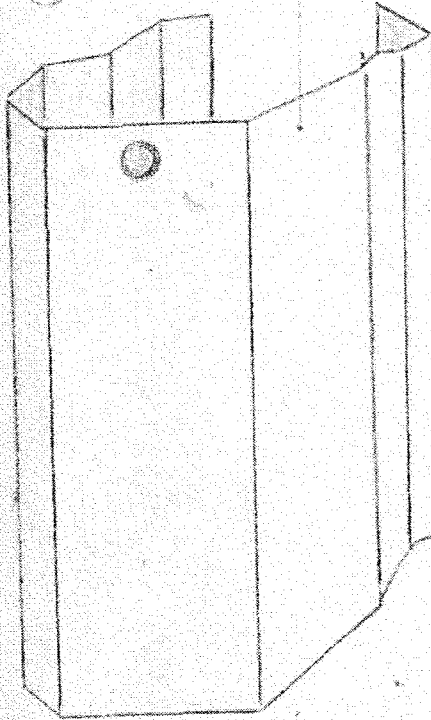

8135

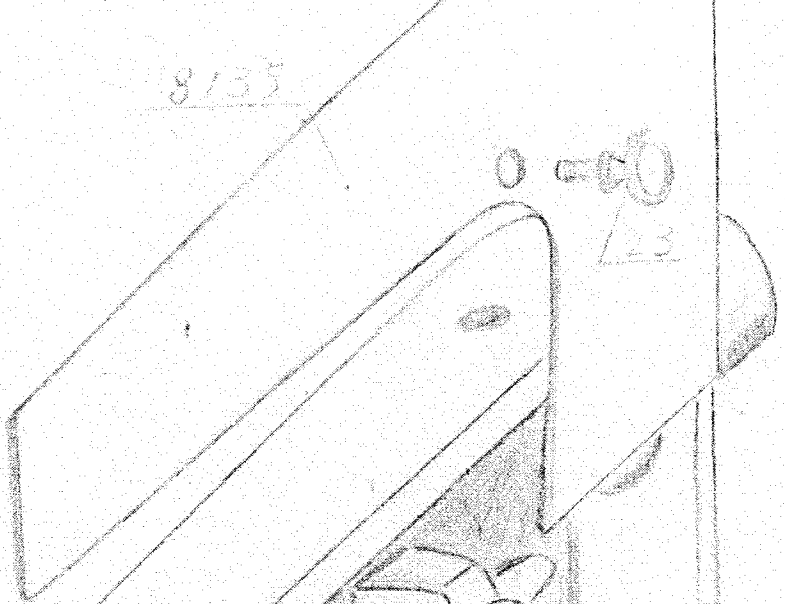

23

8153B

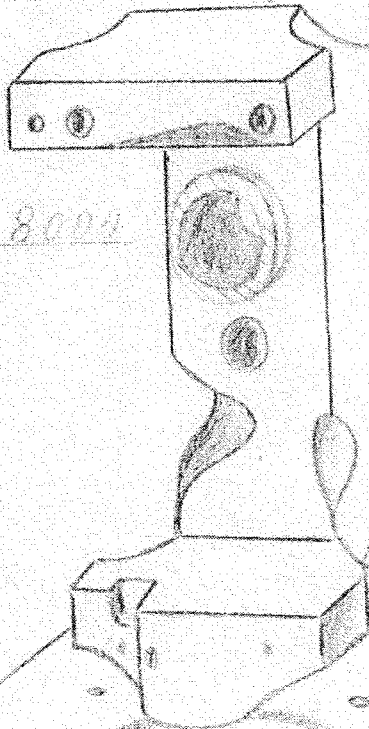

8099

8153A

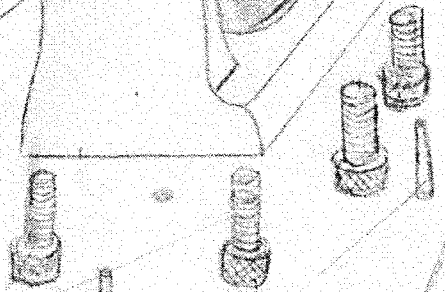

8154

8001

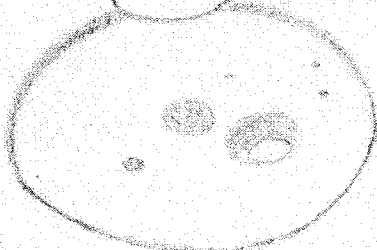

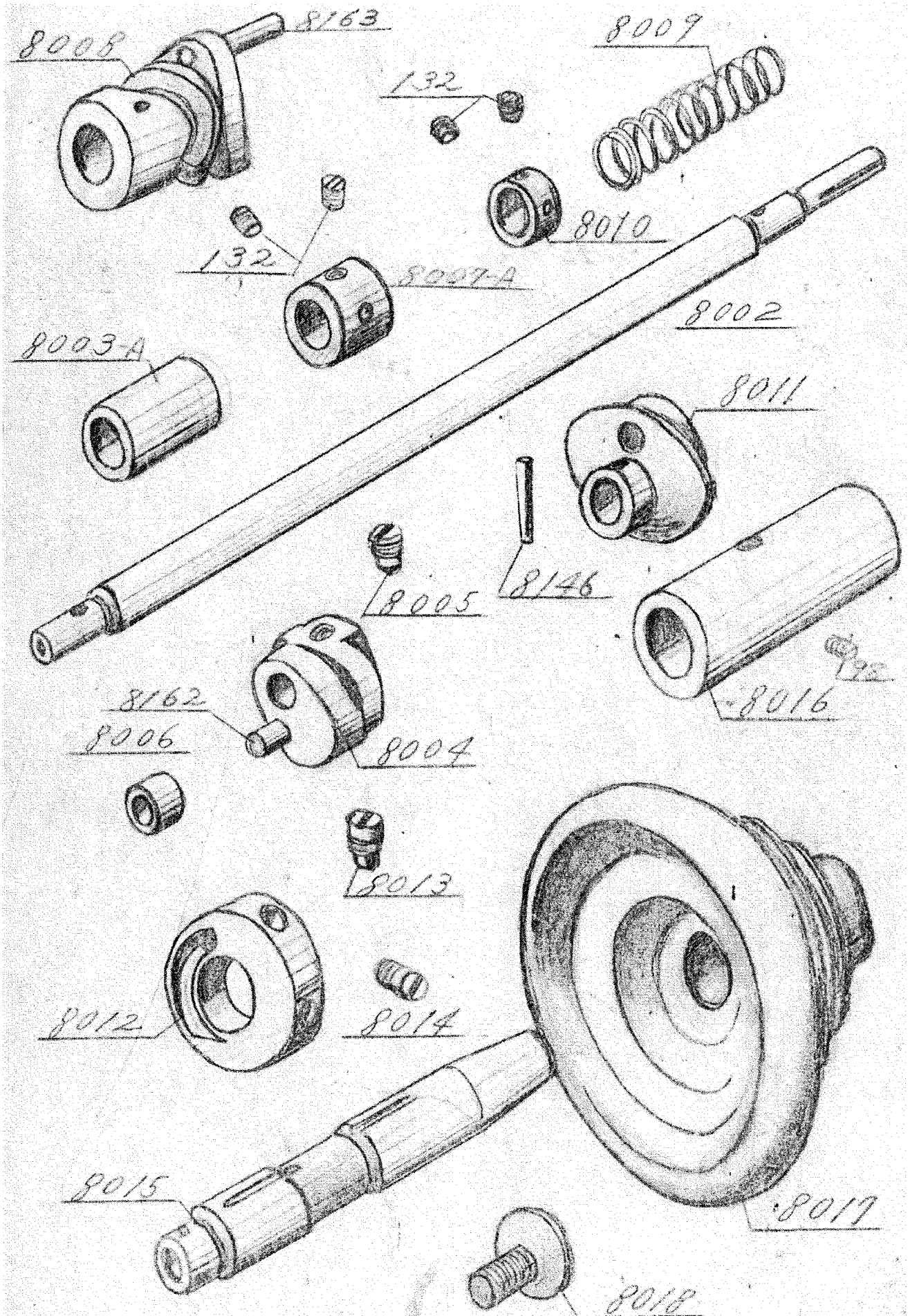

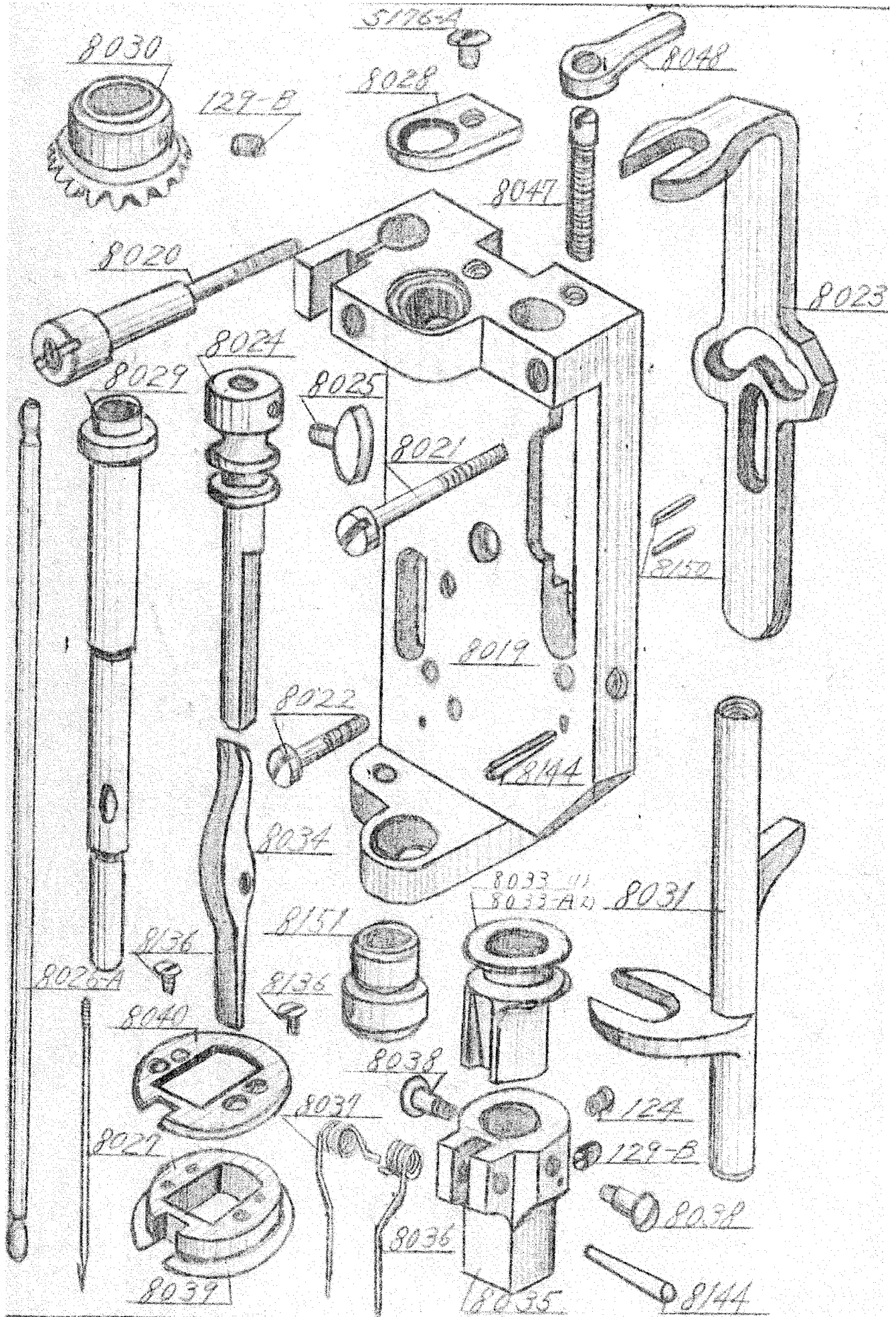

8065

8052

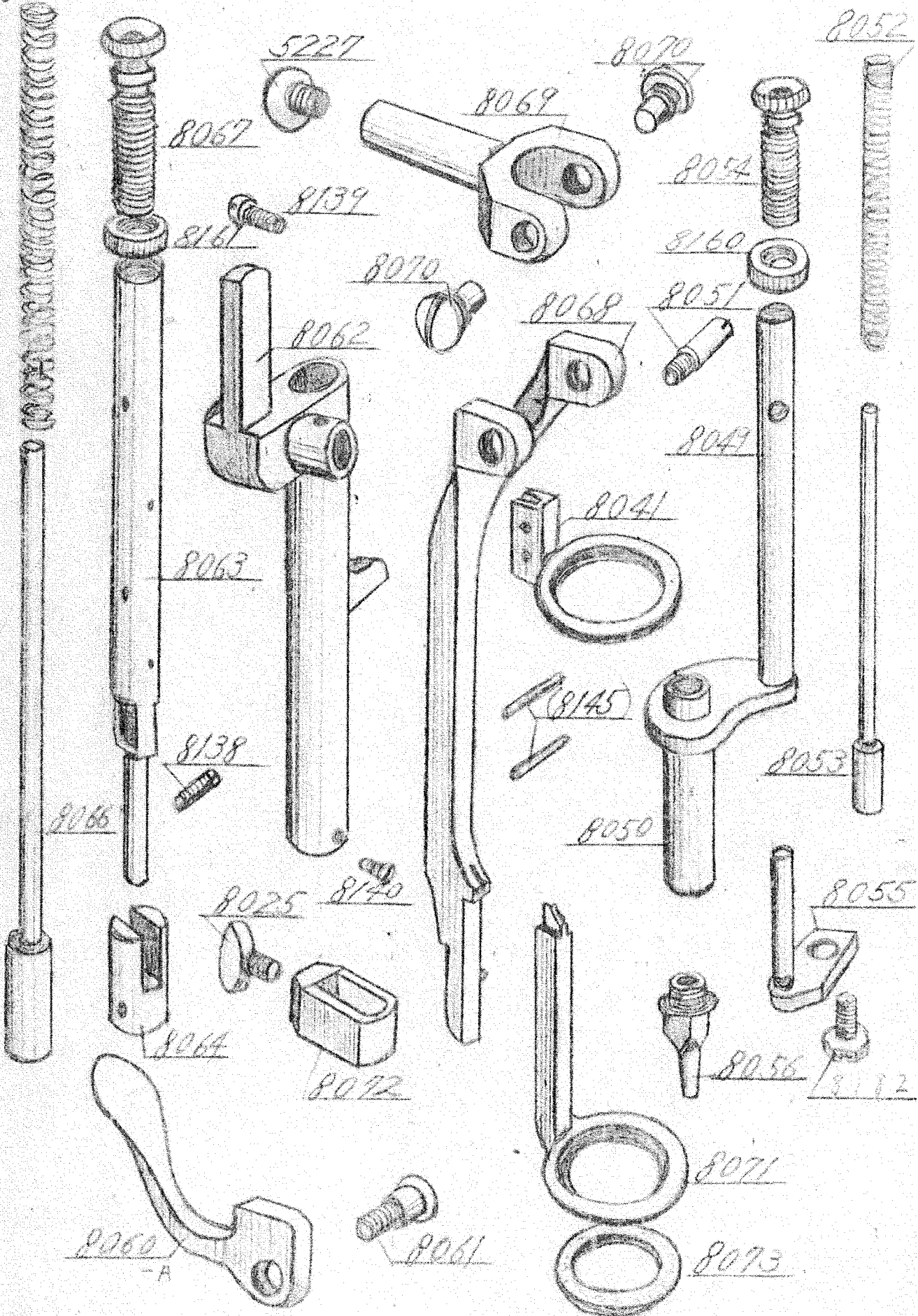

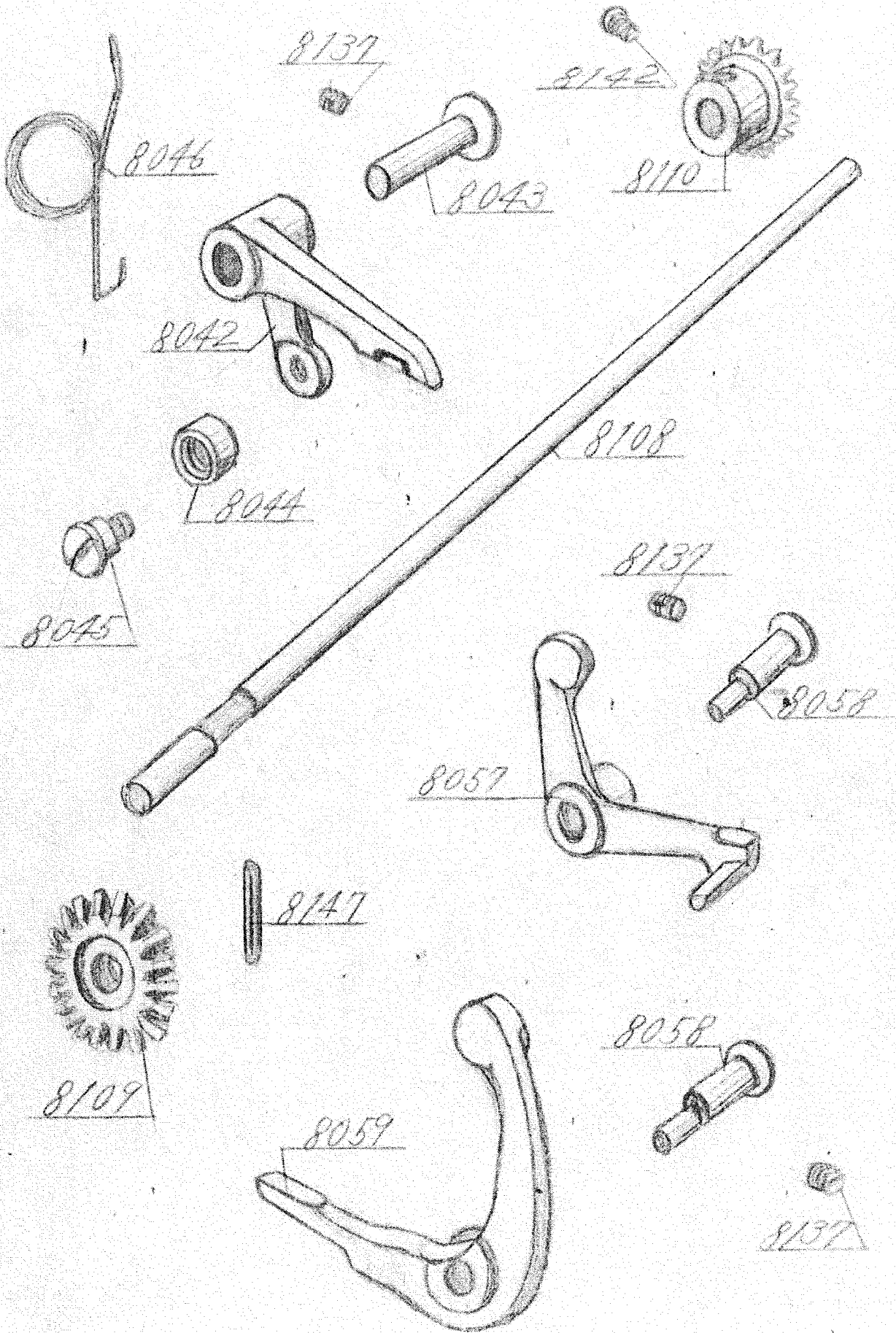



8181



8077

8078



8077



8172



8080

8095-A

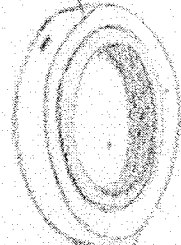

8075



8081

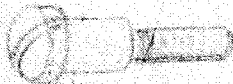
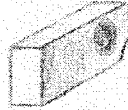

8076



8074

121-B

8142



8110

8180

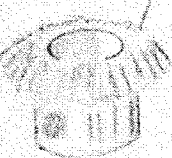

132

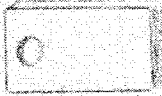

8082

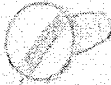

8172



8174

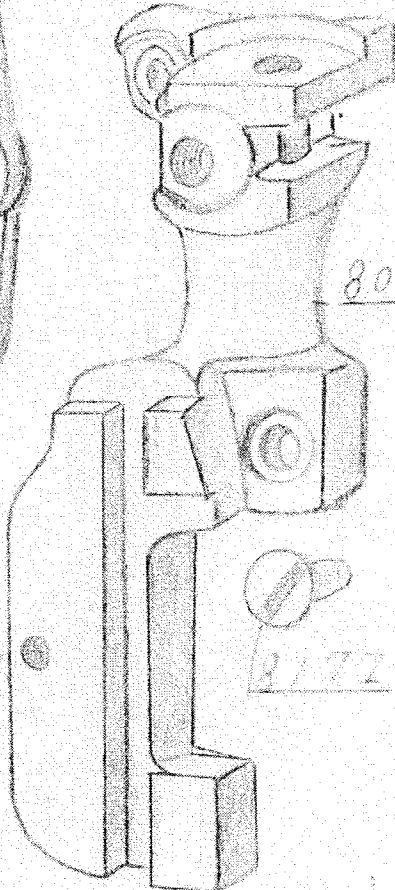

8092

8111



8084

8112

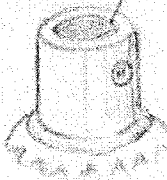

8142



8159

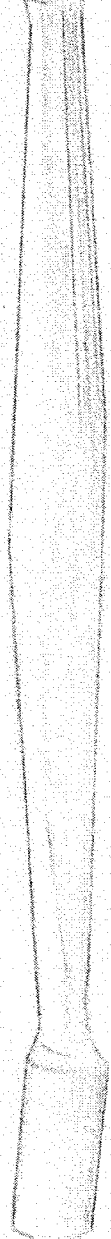
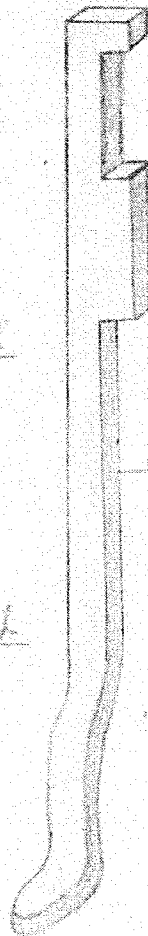

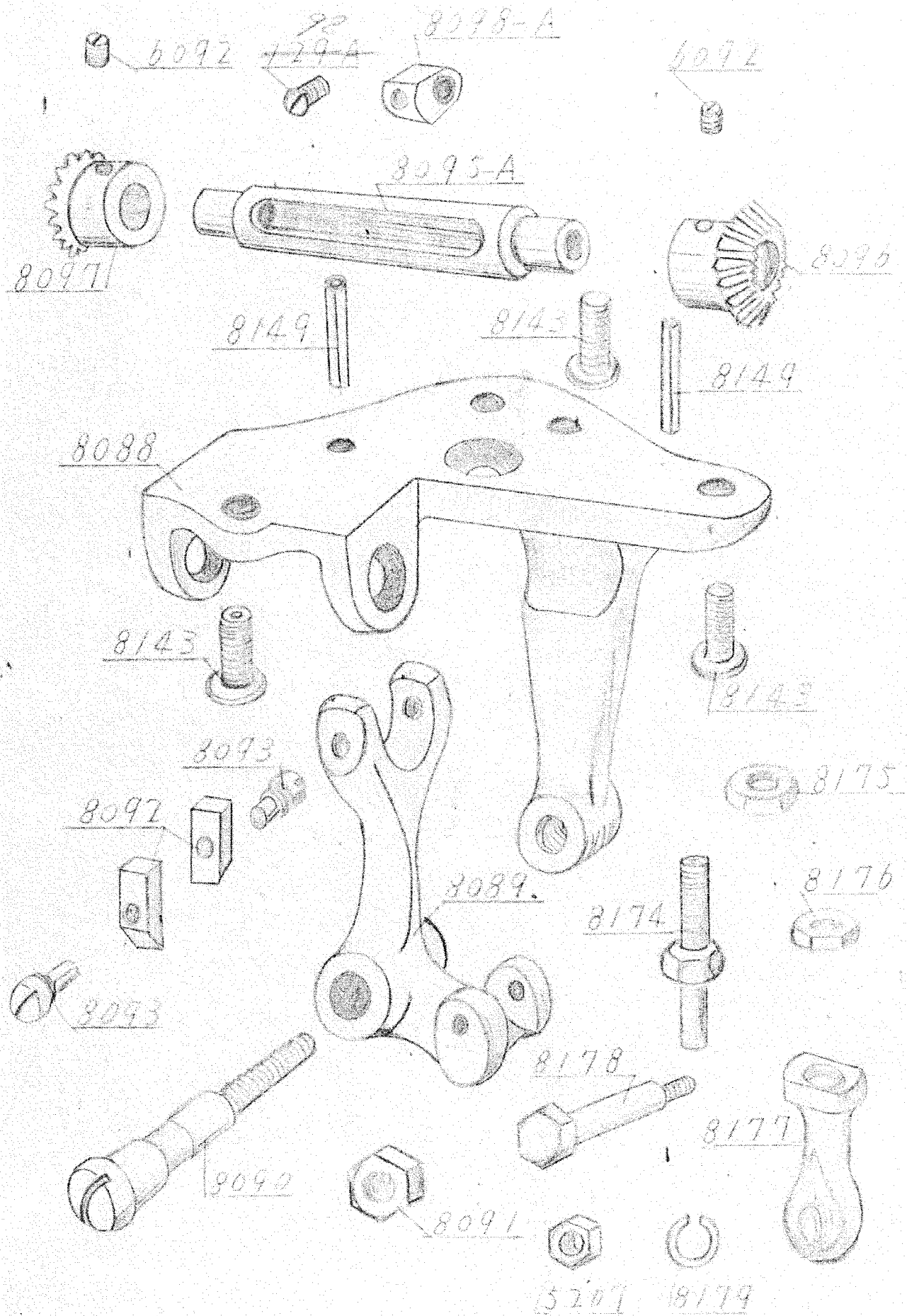

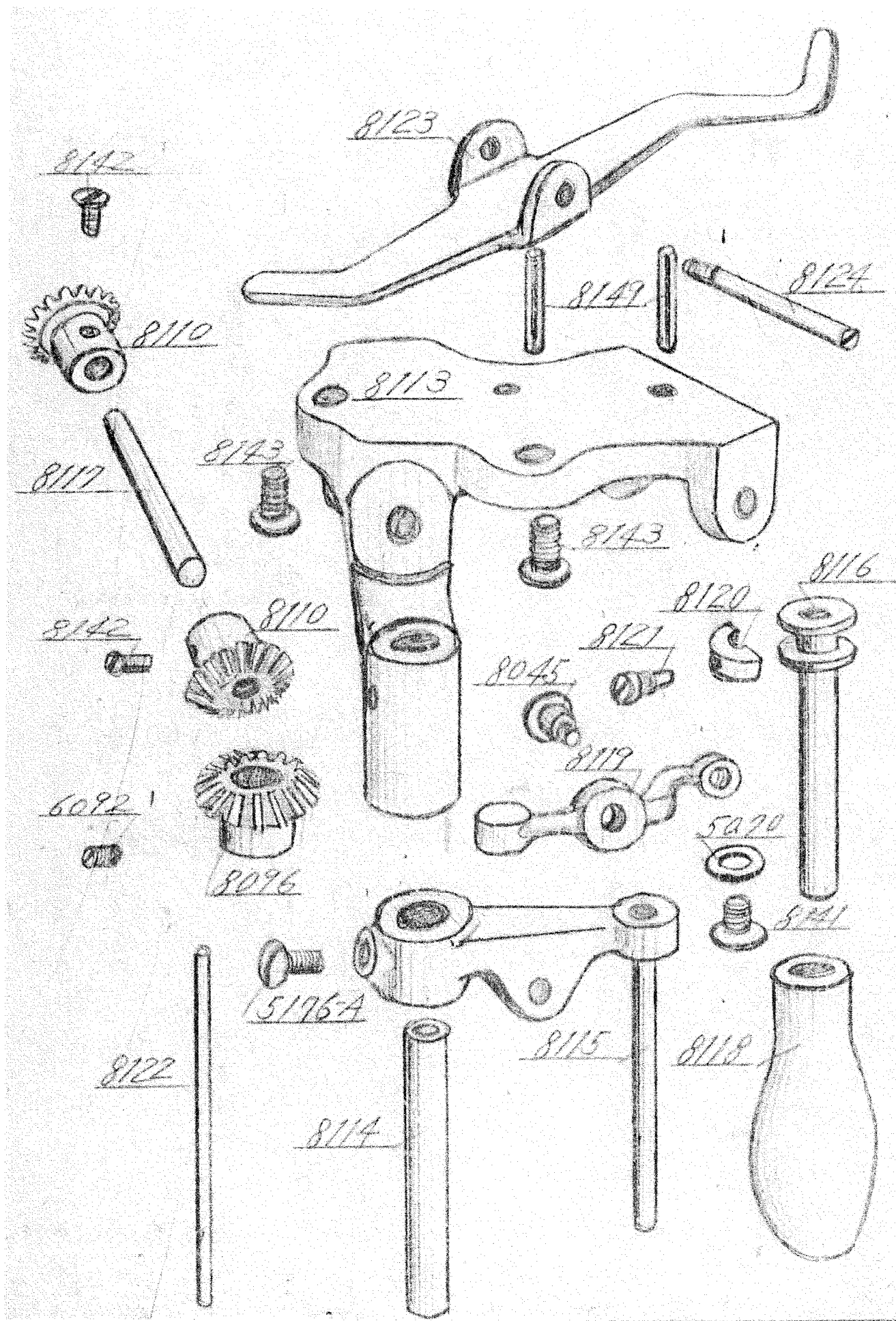

8142

8123

8110

8149

8124

8117

8143

8113

8143

8116

8142

8110

8120

8045

8121

6092-1

8096

8119

5070

15176-A

8144

8122

8115

8118

8114

124



129-B



8100



8101

8106

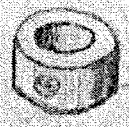
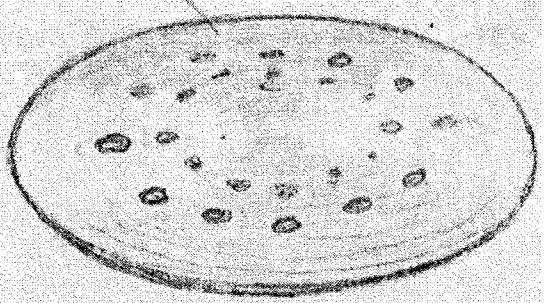

8152

8150



8150

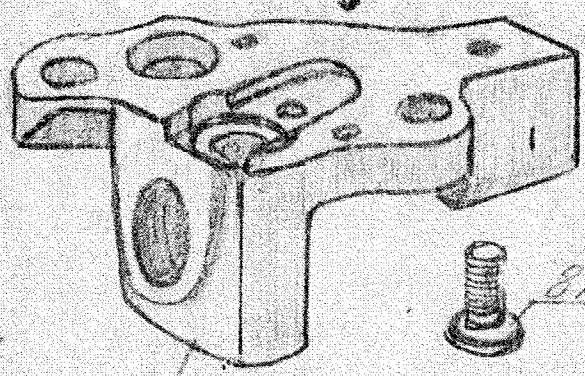

8099

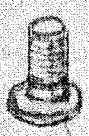

8158



8158

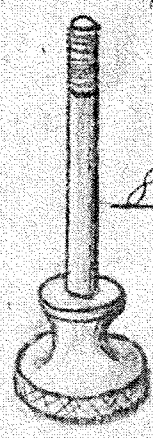

8107

8105



8102

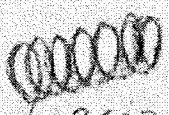
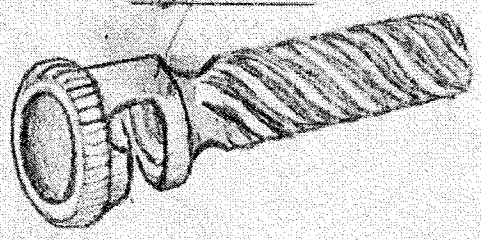

8103



8104

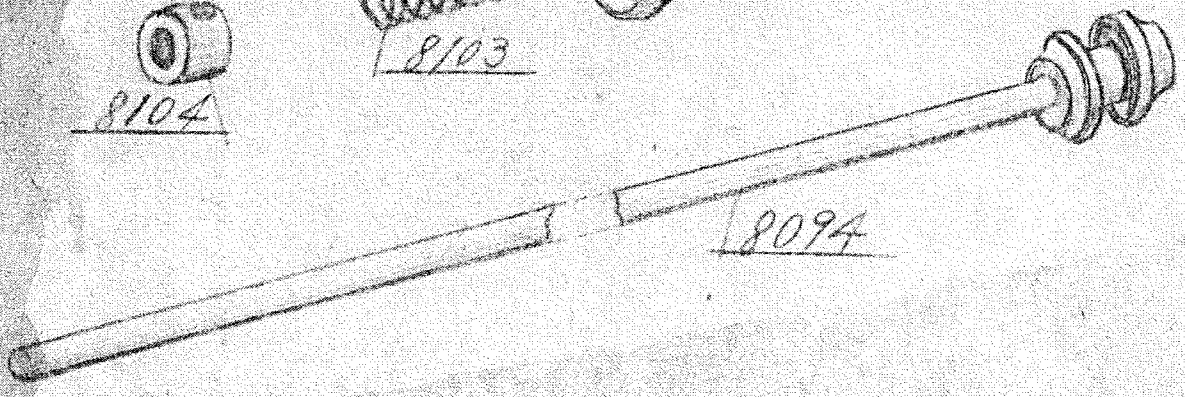

8094

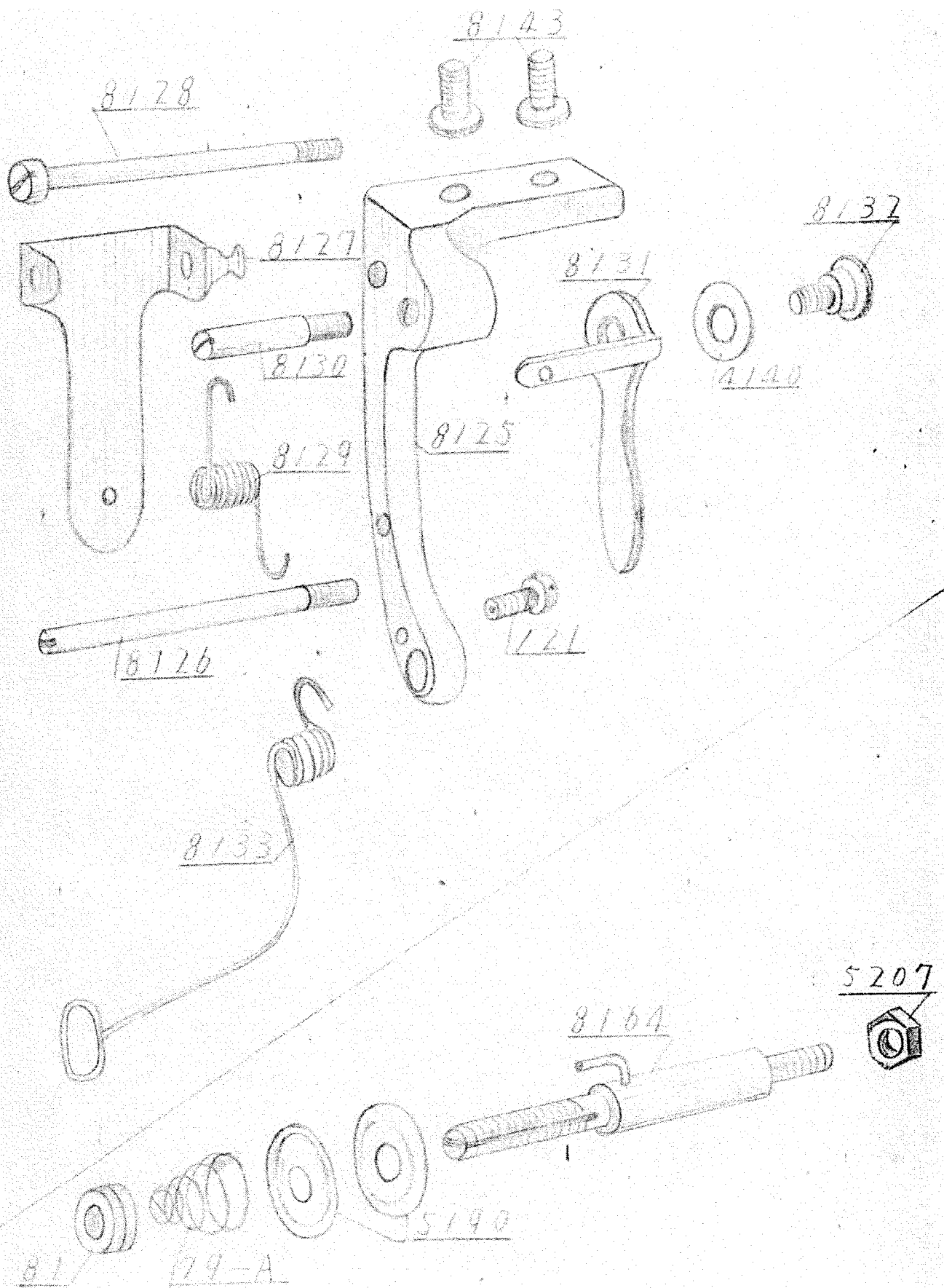

ACCESSORIES FOR MODEL 104

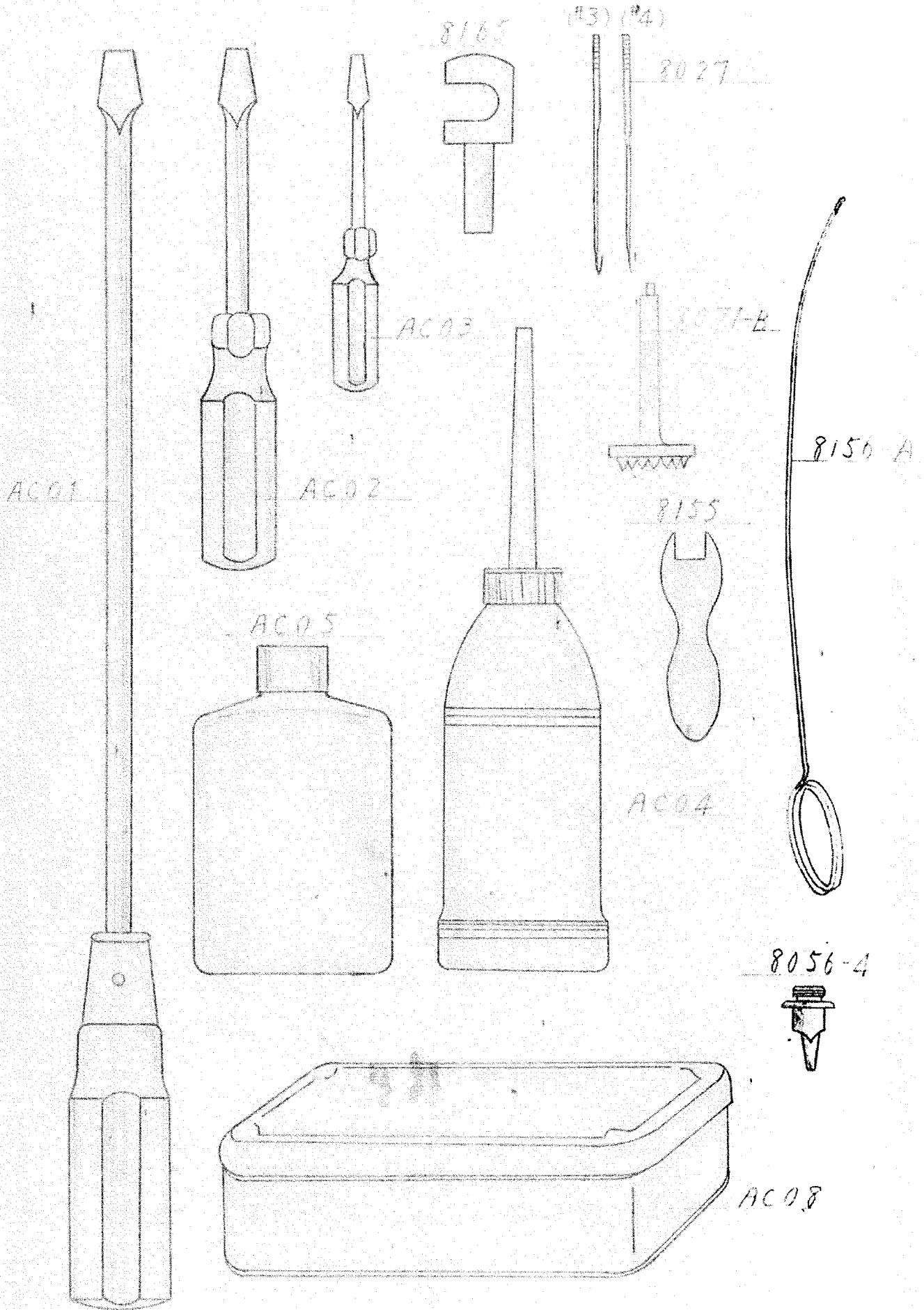

Consolidated Sewing Machine Corp.

Website: www.consew.com

MAIN office

131 W. 25th Street
New York, NY 10001
Tel: 212-741-7788
Fax: 212-741-7787
e-mail: consew@att.net

Miami, FL

4013 N.W. 79th Avenue
Miami, FL 33166
Tel: 305-471-0200
Fax: 305-471-0243
e-mail: miamisales@consew.com

Los Angeles, CA

2320 South Hill Street
Los Angeles, CA 90007
Tel: 213-745-8844
Fax: 213-745-8855
e-mail: lasales@consew.com