



**MODEL**

**SK-2R**

**SK-6FR**

**PARTS BOOK**

# PARTS LIST

SK-2R

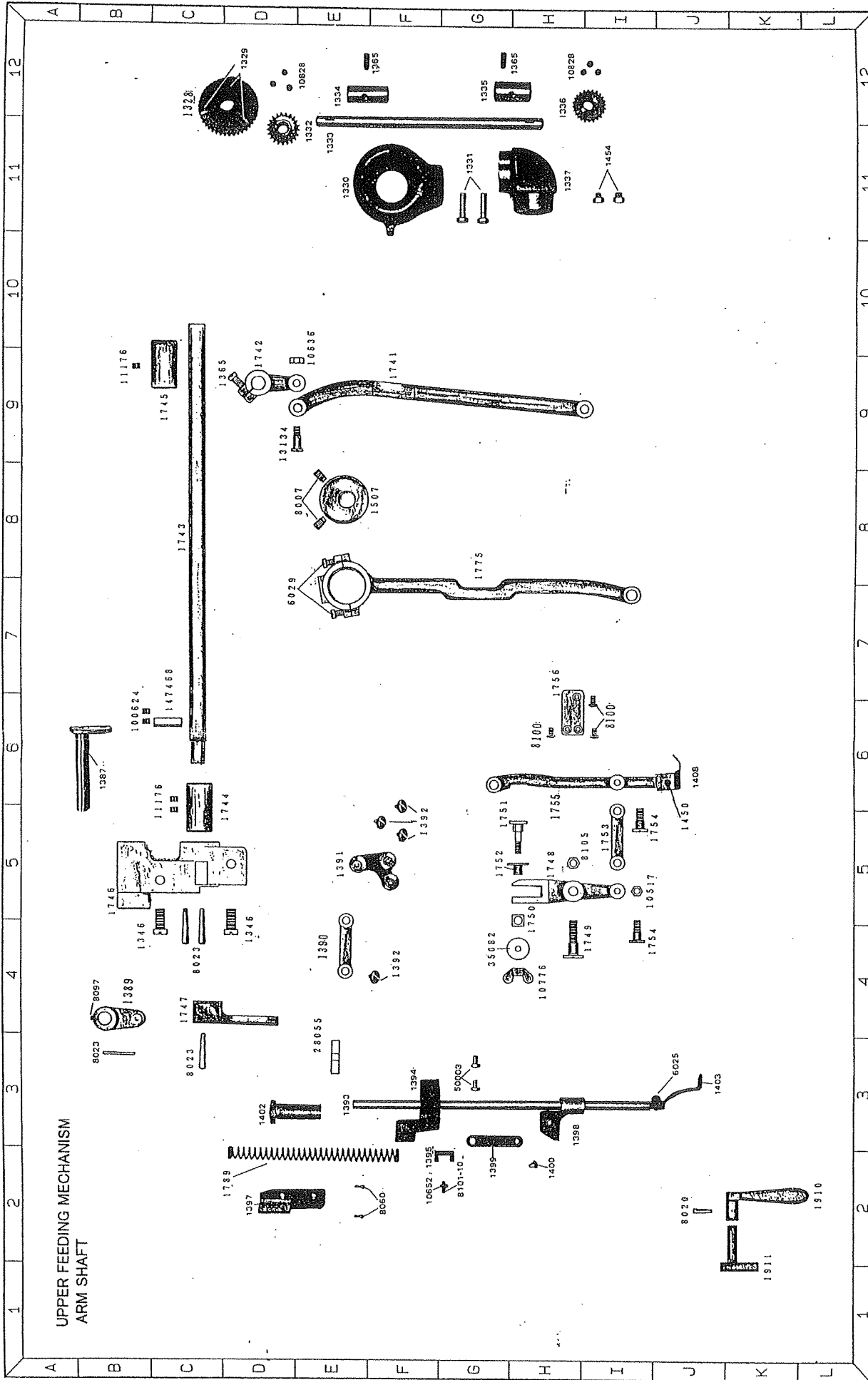

UPPER FEEDING MECHANISM  
ARM SHAFT

UPPER SHAFT  
TAKE UP LEVER

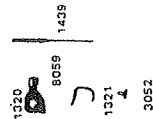
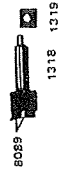
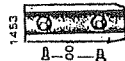
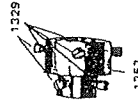
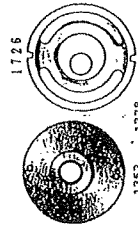
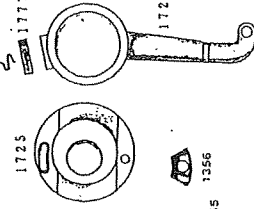
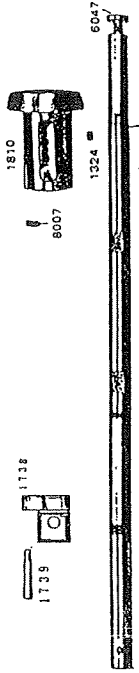
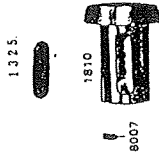
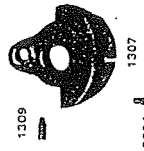
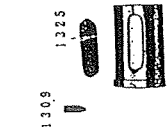
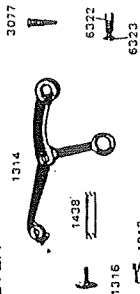
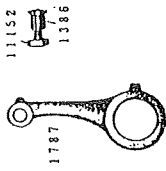

REVERSE STITCH MECHANISM

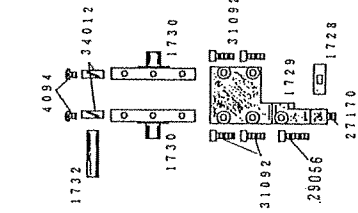
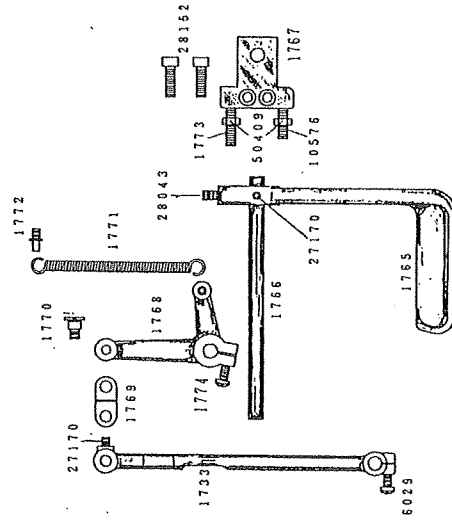
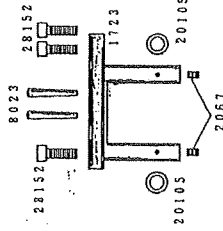

1 2 3 4 5 6 7 8 9 10 11 12

A B C D E F G H I J K L

1 2 3 4 5 6 7 8 9 10 11 12

FACE PLATE, THREAD GUIDE  
KNEE LIFTER LIFTING LEVER, COVER

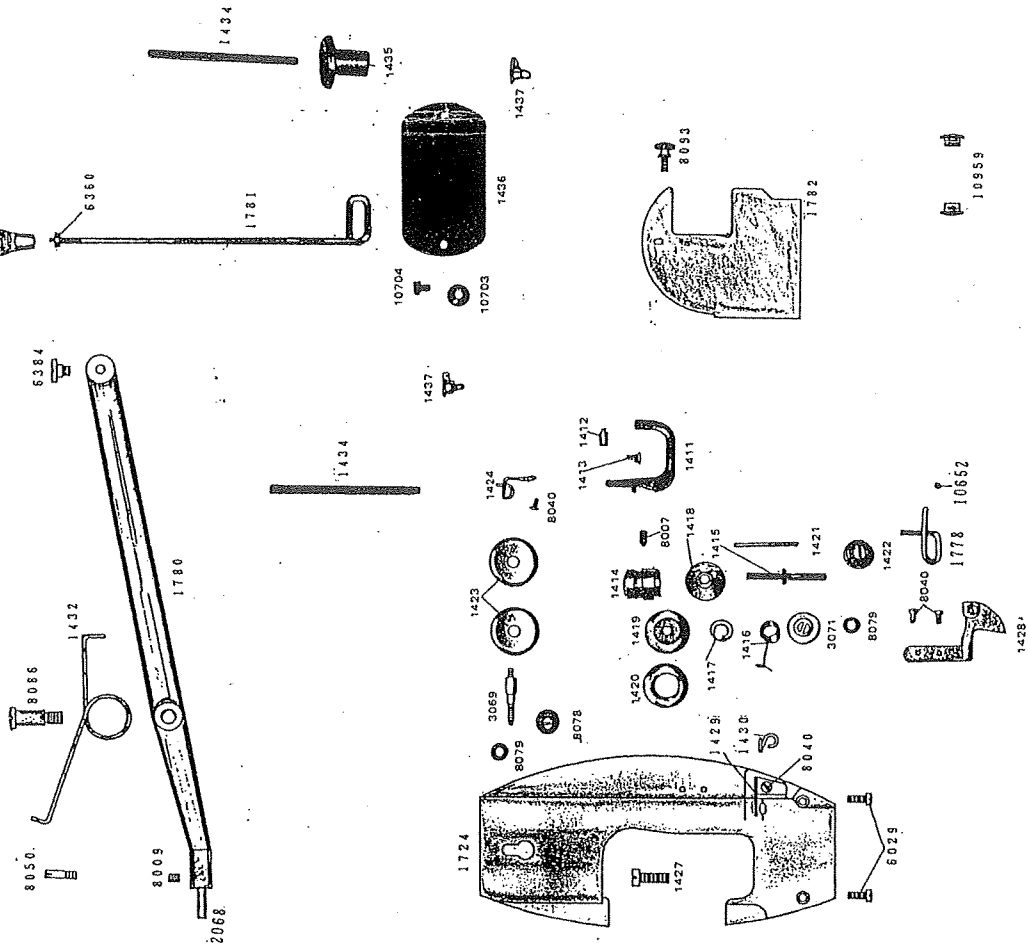

NEEDLE PLATE, FEED FOG, LOWER SHAFT, LOWER FEEDING MECHANISM

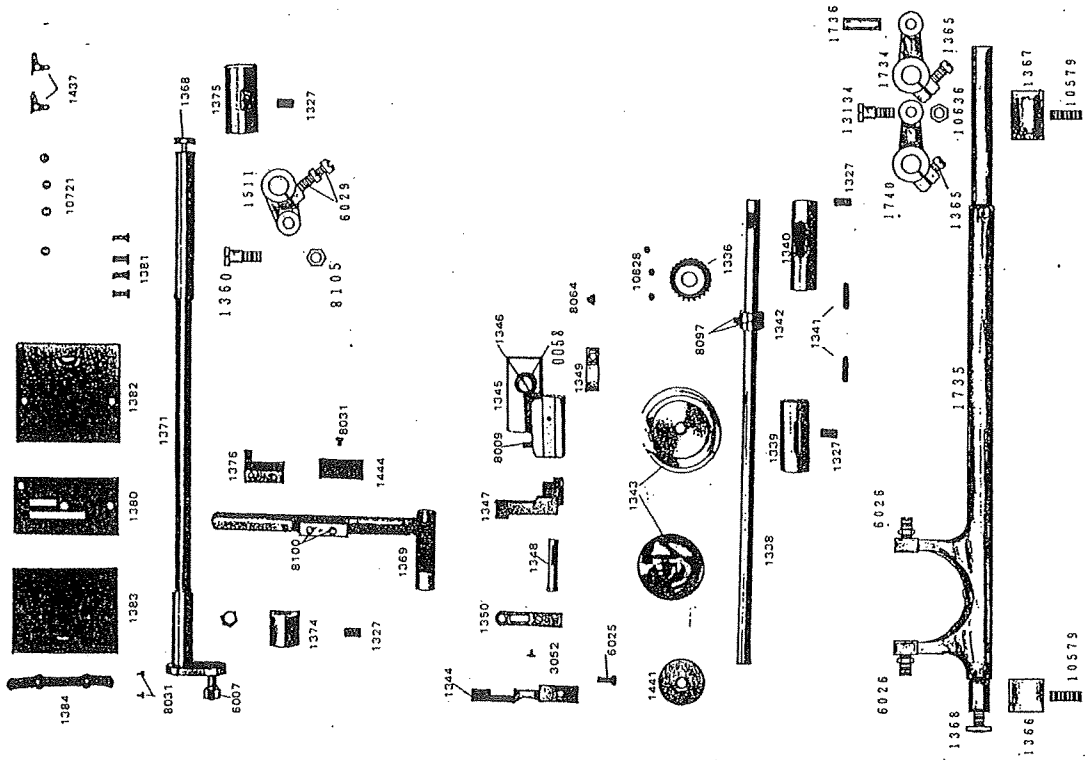



**Consolidated Sewing Machine Corp.**  
Website: [www.consew.com](http://www.consew.com)

**MAIN office**

131 W. 25th Street  
New York, NY 10001  
Tel: 212-741-7788  
Fax: 212-741-7787  
e-mail: [consew@att.net](mailto:consew@att.net)

**Miami, FL**

4013 N.W. 79th Avenue  
Miami, FL 33166  
Tel: 305-471-0200  
Fax: 305-471-0243  
e-mail: [miamisales@consew.com](mailto:miamisales@consew.com)

**Los Angeles, CA**

2320 South Hill Street  
Los Angeles, CA 90007  
Tel: 213-745-8844  
Fax: 213-745-8855  
e-mail: [lasales@consew.com](mailto:lasales@consew.com)