

Form 2616w-Revised
(149)
Printed in U. S. A.

HISTORICAL COPY
DO NOT REMOVE

**LIST
OF
PARTS**

SINGER**

MACHINE No. 108w20

THE SINGER COMPANY

**A Trade Mark of THE SINGER COMPANY

INDEX

	PAGE
ACCESSORIES	11
BINDERS	13
BOBBIN WINDER	11
MACHINE No. 108w20	5
NUMERICAL LIST OF PARTS	15
OBSOLETE PARTS	14
TAPE REEL	12
TREADLE	12

Copyright, U. S. A., 1939, 1940, 1941 and 1949

by The Singer Company

All Rights Reserved for all Countries

INSTRUCTIONS FOR ORDERING

In ordering from this list, use ONLY the PART number in the FIRST column.

The number stamped on a Sewing Machine Part is the number of the Single Part only, except when the part includes Set Screws, Clamping Screws, Studs and Rollers Spun on, Small Wires riveted, or Parts soldered together, etc., which it is necessary to furnish in combination.

Every combination of parts sent out has its specific number which, although not stamped on Parts (except in above case), must be used when ordering the combination.

Each number always indicates the SAME PART in whatever list it appears, or for whatever Machine.

The letters after some of the numbers indicate the style of finish only, as follows:

- A. Hardened, Polished, Nickel Plated and Buffed.
- B. Polished, Nickel Plated and Buffed.
- C. Hardened only.
- D. Polished only.
- E. Soft, not polished.
- F. Hardened and Polished.
- H. Blued.
- J. Nickel Plated only.
- R. Merlized.
- X. Black Oxide, for Iron and Steel.
- XC. Hardened and Black Oxide, for Iron or Steel.
- Y. Black Nickel Plated only.

These letters MUST BE USED when they appear in the list and AFTER the number, as in the list.

In this series

1 to 1500, 200001 to 201500 and 350001 to 351500 are Screw Numbers.
 1501 to 1800, 201501 to 201800 and 351501 to 351800 are Nut Numbers.
 1801 to 2000, 201801 to 202000 and 351801 to 352000 are Roller Numbers.
 2001 to 50000 and 202001 to 350000 are Numbers of Machine Parts.

The figures in the second column refer only to the plate in which the illustration of the part is shown and are NOT TO BE USED in ordering.

Two or more numbers over a cut indicate that the difference between such parts is not visible in an illustration.

Parts marked with an asterisk (*) are furnished only when repairs are made at the factory.

LIST OF PARTS COMPLETE

FOR

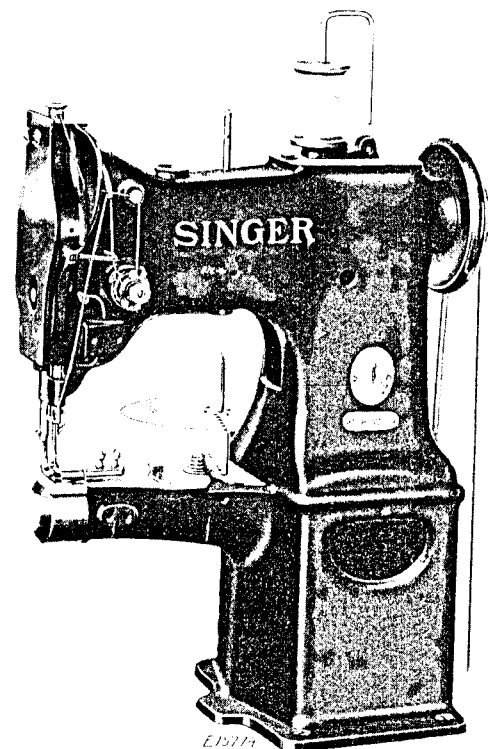

MACHINE No. 108w20

UNISON FEED.

FOR BINDING SHOE TONGUES, BUTTON STRAPS,

DRESS SHIELDS, ETC.

No.	Plate	Name
*208521	----	Arm with 202135
203091	13481	" Cap
200278H	13481	" " Screw
202248	13481	" " Washer
203089	13481	" " Spool Holder Base
203090	13481	" " " " " 203089 with 200079H and 204296
200585H	13481	Arm Cap Spool Holder Base Screw
204296	13481	" " " " Wire

No.	Plate	Name
202443	13481	Feed Regulating Spindle Head Pin
202619	13481	" " " " Position Pin
224709	13487	Foot Lifter Lifting Lever
200262H	13487	" " " " Hinge Screw
247789	-----	Hook (sewing) with two 462AL
247790	13491	" 247789 with 45761, 200145C, 200596F, 200614C, 203101 and 206852
247791	13491	Hook and Bobbin Case complete, Nos. 202533 and 247790
206852	13491	Hook Gib
200614C	13491	" " Hinge Screw
200596F	13491	" " Screw
203101	13491	" Oil Wick
462AL	13491	" Set Screw
244200	13491	" Shaft
202321	13482	" " Bushing (back)
200346C	13482	" " " " Set Screw
202322	13482	" " " (front)
200346C	13482	" " " " Set Screw
224516	13482	" " Connection Belt Pulley with 202324 and two 201018C
201018C	13482	Hook Shaft Connection Belt Pulley Set Screw
202324	13482	Hook Shaft Connection Belt Pulley Spring Flange
224392	13482	Hook Shaft Oil Packing (wick) (2)
45761	13491	" Washer
200145C	13491	" " Screw
208545	13484	Lifting Bell Crank
208546	13484	" " " " Driving Crank
208547	13484	" " " " " Link
202277	13484	" " " " " Oil Packing (wick)
201012C	13484	Lifting Bell Crank Driving Crank Position Screw
200374C	13484	Lifting Bell Crank Driving Crank Set Screw
200996C	13484	Lifting Bell Crank Stop Screw
224703	13489	" Presser Foot
200074F	13485	" " " Screw
208526	13484	Needle Bar with 200141F
208549	13487	" " and Needle Plate Carrier Frame with 200362C, 200997C and 208550
224741	13487	Needle Bar and Needle Plate Carrier Frame Hinge Plate
210983	13487	Needle Bar and Needle Plate Carrier Frame Hinge Plate Position Pin
200054E	13487	Needle Bar and Needle Plate Carrier Frame Hinge Plate Screw (4)
350308C	13487	Needle Bar and Needle Plate Carrier Frame Hinge Screw
200998C	13487	Needle Bar and Needle Plate Carrier Frame Hinge Screw Stud

No.	Plate	Name
208550	13487	Needle Bar and Needle Plate Carrier Frame Hinge Screw Stud Bushing (split)
200997C	13487	Needle Bar and Needle Plate Carrier Frame Hinge Screw Stud Bushing Position Screw
202277	13487	Needle Bar and Needle Plate Carrier Frame Hinge Screw Stud Oil Packing (wick)
208551	13484	Needle Bar Connecting Link
208552	13484	" " " Stud with 200086C and 202330
202330	13484	Needle Bar Connecting Stud Oil Packing (wick)
200086C	13484	Needle Bar Connecting Stud Pinch Screw
208553	13484	" " Crank with 200335C, 200374C, 200428C and 201012C
208582	13484	Needle Bar Crank 208553 with 200996C, 202398, 202400, 208545 to 208547, 208551, 208552, 208555, 208557, 208562 and 208563
203172	13484	Needle Bar Crank Friction Washer
200428C	13484	" " " Position Screw
200335C	13484	" " " Set Screw
224704	13489	" Plate, 50 needle hole, for needle sizes 14 and 15
201387F	13489	Needle Plate Screw
224705	13482	" " Slide Plate (adjustable)
200054E	13482	" " " " Screw
200141F	13484	" Set Screw
224527	13482	Oil Leader (brass) (for back hook shaft bearing)
208566	13485	Presser Bar with 200074F
208567	13485	" " Bushing
200352C	13485	" " " Set Screw
208313	13485	" " Lifter
200653C	13485	" " " Hinge Screw
208555	13484	" " Lifting Bracket with 200054E
200975F	13485	Presser Bar Lifting Bracket Guide Screw
200054E	13484	" " " " Pinch Screw
208556	13485	" " Spring
200494H	13485	" " Thumb Screw (pressure regulating)
200475H	13485	Presser Bar Thumb Screw Thumb Set Screw
202355	13485	" " " " " " " " Packing (brass)
202397	13484	Take-up (auxiliary)
200842E	13484	" " " Screw
202398	13484	" Lever
208557	13484	" " Driving Stud with 202277
202277	13484	" " " " Oil Packing (wick)
202400	13484	Take-up Lever Hinge Stud with 202423
202423	13484	" " " " Oil Packing (wick)

No.	Plate	Name
200383C	13484	Take-up Lever Hinge Stud Set Screw
208558	13484	" " Oil Guard with 223655 and 224572
200161H	13484	Take-up Lever Oil Guard Screw
208568	13485	" " " Leader
202254	13485	" " " Packing (wick)
223655	13484	" " Oiling Felt
224572	13484	" " " Rivet
200040H	13490	Tape Reel Bracket Screw (2)
244048	13486	Tension Disc (back)
244049	13486	" " (front)
202404	13485	" Release Plunger
233629	13485	" " Slide
208560	13485	" " " Spring
244061	13486	" " Washer
202407	13486	" Spring
263106	13486	" " Washer
200625F	13486	" Stud with 204925
200061C	13486	" " Set Screw
204925	13486	" " Washer
201572H	13486	" Thumb Nut
244062	13486	Tension complete, Nos. 200625F, 201572H, 202407, 202410, 244048, 244049, 244061 and 263106
202410	13486	Thread Controller Spring
241443	13486	" " " Stop
200132E	13486	" " " Screw
208574	13486	" Guide
202412	13481	" " "
202415	13486	" " "
208569	13486	" " "
200582H	13486	" " Screw
200397H	13486	" " Set Screw
202091	13486	" Retainer Sleeve
202092	13486	" " Spring
204058	13486	" " Stud
200366H	13486	" " " Set Screw
204059	13486	Thread Retainer complete, Nos. 202091, 202092 and 204058
224707	13487	Throat Plate
200577AL	13487	" " Screw (2)
208562	13484	Vibrating Presser Bar
208563	13484	" " " Connecting Link
202277	13484	" " " Oil Packing (wick)
224708	13489	Vibrating Presser Foot, 46 needle hole, with 201015F
201015F	13489	Vibrating Presser Foot Pinch Screw

ACCESSORIES

No.	Plate	Name
202265	13491	Bobbin (5)
228476	13490	Screw Driver (Bobbin Case)
51078	13490	Machine Bolt (4)
6055	13490	" " Washer (4)
135x1	-----	Needles, three each, sizes 12 and 14
120342	13490	Oiler with 120343
120343	13490	" Spout, 3-1/2 in. long
225498	13490	Screw Driver (7-1/4 in. long)
225554	13490	Wrench (steel)

BOBBIN WINDER

(SWINGING AUTOMATIC, RIGHT HAND)

FOR 5/16" ROUND BELT DRIVE

259428	16615	Brake (leather)
259429	16615	" Clamp
200113F	16615	" " Screw
225453	16615	Frame with 202277 and 259660
225454	16615	" Hinge Pin
202277	16615	" Oil Packing (wick)
259660	16615	" " Well Washer
225455	16615	" Spring
225456	16615	" " Plunger
225368	16615	Pulley with 200380C
200380C	16615	" Set Screw
225381	16615	Spindle
225444	16615	Stop Latch
200056E	16615	" " Screw
225458	16615	" " Thumb Lever
225459	16615	" " " Hinge Stud
225459	16615	" " " Joint Stud
202478	16615	" " Trip Lever
200299H	16615	" " " Hinge Screw
225461	16615	Tension Bracket with 201499H
200082D	16615	" " Screw
228026	16615	" " " Washer
2102	16615	" Disc
13710	16615	" Spring
201499H	16615	" Stud
201572H	16615	" " Thumb Nut
225462	16615	Bobbin Winder Tension Bracket com- plete, Nos. 13710, 201572H, 225461 and two 2102

ACCESSORIES

No.	Plate	Name
259430	16615	Bobbin Winder and Tension Bracket Base
259431	16615	Universal Bobbin Winder complete, Nos. 200056E, 200082D, 200113F, 200299H, 202478, 225368, 225381, 225444, 225453 to 225456, 225458, 225462, 228026, 259428 to 259430, two each 225459 and wood screws 3/4 in., No. 12, R.H.B.

TAPE REEL

226200	13490	Tape Reel (6 in. diam.) with 225666
224717	13490	" " Bracket
230471	13490	" " Hub
225666	13490	" " " 230471 with 225980
225980	13490	" " " Base
224718	13490	Tape Reel (6 in. diam.) complete, Nos. 224717 and 226200

TREADLE, SINGLE FOOT (Right)

228424	13490	Treadle with 200526C
228425	13490	" Chain, 38 in. long with 202784
202784	13490	" " Hook
200526C	13490	" Set Screw
228426	13490	" Shaft
228427	13490	" Spring
228428	13490	" Stand with two wood screws 7/8 in., No. 12
228429	13490	Treadle, single foot (right) complete, Nos. 228424 to 228428

BINDERS

No.	Plate	Name
230251	13488	Binder Head Clamp Washer
350255E	13488	" " Screw Stud
201562H	13488	" " Thumb Nut
224738	13488	" Swing Base with two 350255E
200247F	13488	" " " Hinge Screw
201531E	13488	" " " " " Nut
225708	13488	" " " Spring
208329	13488	" Tape Guide, for tapes or folded strips from 3/8 to 3/4 in., in steps of 1/32 inch
224725	13488	Binder Tape Guide, for 5/16 and 11/32 in. tapes or folded strips
200907B	13488	Binder Tape Guide Screw
228999	13488	" " Tension Pin
224716	13488	" " " Plate with seven 228999
224710	13488	Binder Head, .025 in. opening, for tapes or folded strips from 5/16 to 3/4 in., in steps of 1/32 inch
224719	13488	Binder complete, .025 in. opening, for tapes or folded strips from 3/8 to 3/4 in., in steps of 1/32 in., Nos. 200247F, 201531E, 208329, 224710, 224716, 224738, 225708, 230251, two each 200907B and 201562H
224711	13488	Binder Head, .030 in. opening, for tapes or folded strips from 5/16 to 3/4 in., in steps of 1/32 inch
224720	13488	Binder complete, .030 in. opening, for tapes or folded strips from 3/8 to 3/4 in., in steps of 1/32 in., Nos. 200247F, 201531E, 208329, 224711, 224716, 224738, 225708, 230251, two each 200907B and 201562H
224712	13488	Binder Head, .035 in. opening, for tapes or folded strips from 5/16 to 3/4 in., in steps of 1/32 inch
224721	13488	Binder complete, .035 in. opening, for tapes or folded strips from 3/8 to 3/4 in., in steps of 1/32 in., Nos. 200247F, 201531E, 208329, 224712, 224716, 224738, 225708, 230251, two each 200907B and 201562H
224726	13488	Binder complete, .025 in. opening, for 5/16 and 11/32 in. tapes or folded strips, Nos. 200247F, 201531E, 224710, 224716, 224725, 224738, 225708, 230251, two each 200907B and 201562H

BINDERS

No.	Plate	Name
224727	13488	Binder complete, .030 in. opening, for 5/16 and 11/32 in. tapes or folded strips, Nos. 200247F, 201531E, 224711, 224716, 224725, 224738, 225708, 230251, two each 200907B and 201562H
224728	13488	Binder complete, .035 in. opening, for 5/16 and 11/32 in. tapes or folded strips, Nos. 200247F, 201531E, 224712, 224716, 224725, 224738, 225708, 230251, two each 200907B and 201562H
224729	13488	Binder complete, .040 in. opening, for 5/16 and 11/32 in. tapes or folded strips, Nos. 200247F, 201531E, 224713, 224716, 224725, 224738, 225708, 230251, two each 200907B and 201562H
224730	13488	Binder complete, .045 in. opening, for 5/16 and 11/32 in. tapes or folded strips, Nos. 200247F, 201531E, 224714, 224716, 224725, 224738, 225708, 230251, two each 200907B and 201562H
224713	13488	Binder Head, .040 in. opening, for tapes or folded strips from 5/16 to 3/4 in., in steps of 1/32 inch
224722	13488	Binder complete, .040 in. opening, for tapes or folded strips from 3/8 to 3/4 in., in steps of 1/32 in., Nos. 200247F, 201531E, 208329, 224713, 224716, 224738, 225708, 230251, two each 200907B and 201562H
224714	13488	Binder Head, .045 in. opening, for tapes or folded strips from 5/16 to 3/4 in., in steps of 1/32 inch
224723	13488	Binder complete, .045 in. opening, for tapes or folded strips from 3/8 to 3/4 in., in steps of 1/32 in., Nos. 200247F, 201531E, 208329, 224714, 224716, 224738, 225708, 230251, two each 200907B and 201562H

OBSOLETE PARTS

202530	-----	Arm Shaft Connection Belt
202252	-----	" " " " Pulley with 200327C, 200602C and two 202253
202323	-----	Hook Shaft Connection Belt Pulley with 202324 and two 201018C
206751	-----	Hook Washer

NUMERICAL LIST OF PARTS

No.	Plate	Name
462AL	13491	Hook Set Screw, for 247789
2102	16615	Bobbin Winder Tension Disc, for 225462
6055	13490	Machine Bolt Washer
13710	16615	Bobbin Winder Tension Spring, for 225462
45761	13491	Hook Washer, for 247790
51078	13490	Machine Bolt
120342	13490	Oiler with 120343
120343	13490	" Spout, 3-1/2 in. long, for 120342
200010E	13487	Arm Screw
200040H	13490	Tape Reel Bracket Screw
200054E	13487	Needle Bar and Needle Plate Carrier Frame Hinge Plate Screw
200054E	13482	Needle Plate Slide Plate Screw
200054E	13484	Presser Bar Lifting Bracket Pinch Screw, for 208555
200056E	16615	Bobbin Winder Stop Latch Screw, for 259431
200061C	13486	Tension Stud Set Screw
200074F	13485	Lifting Presser Foot Screw, for 208566
200079H	13481	Arm Cap Spool Holder Wire Hinge Screw, for 203090
200082D	16615	Bobbin Winder Tension Bracket Screw, for 259431
200086C	13484	Needle Bar Connecting Stud Pinch Screw, for 208552
200113F	16615	Bobbin Winder Brake Clamp Screw, for 259431
200132E	13486	Thread Controller Spring Stop Screw
200141F	13484	Needle Set Screw, for 208526
200145C	13491	Hook Washer Screw, for 247790
200161H	13484	Take-up Lever Oil Guard Screw
200247F	13488	Binder Swing Base Hinge Screw, for 224719 to 224723 and 224726 to 224730
200262H	13487	Foot Lifter Lifting Lever Hinge Screw
200278H	13481	Arm Cap Screw
200299H	16615	Bobbin Winder Stop Latch Trip Lever Hinge Screw, for 259431
200327C	13482	Arm Shaft Connection Belt Pulley Set Screw, for 202252 and 224514
200328C	13481	Balance Wheel Position Screw, for 244063
200335C	13481	Arm Shaft Counter Balance Set Screw, for 208573
200335C	13481	Balance Wheel Set Screw, for 244063
200335C	13484	Needle Bar Crank Set Screw, for 208553
200338C	13481	Arm Shaft Bushing (back) Set Screw
200338C	13481	" " " (front) Set Screw
200346C	13482	Hook Shaft Bushing (back) Set Screw
200346C	13482	" " " (front) Set Screw
200352C	13485	Presser Bar Bushing Set Screw

NUMERICAL LIST OF PARTS

No.	Plate	Name
200362C	13487	Feed Driving Connection Stud Set Screw, for 208549
200366H	13486	Thread Retainer Stud Set Screw
200374C	13484	Lifting Bell Crank Driving Crank Set Screw, for 208553
200380C	16615	Bobbin Winder Pulley Set Screw, for 225368
200383C	13482	Feed Driving Eccentric Regulating Screw Check Screw
200383C	13484	Take-up Lever Hinge Stud Set Screw
200397H	13486	Thread Guide Set Screw
200428C	13484	Needle Bar Crank Position Screw, for 208553
200429F	13482	Feed Driving Eccentric Regulating Screw
200462H	13487	Face Plate Thumb Screw
200475H	13485	Presser Bar Thumb Screw Thumb Set Screw
200494H	13485	" " " (pressure regulating)
200502H	13481	Arm Shaft Bushing (front) Oil Packing Thumb Screw
200526C	13490	Treadle Set Screw, for 228424
200577AL	13488	Binder Tape Tension Plate Screw
200577AL	13487	Throat Plate Screw
200582H	13486	Thread Guide Screw
200585H	13481	Arm Cap Spool Holder Base Screw, for 203092
200594C	13491	Bobbin Case Tension Spring Screw, for 202533
200596F	13491	Hook Gib Screw, for 247790
200602C	13482	Arm Shaft Connection Belt Pulley Position Screw, for 202252 and 224514
200607C	13482	Feed Driving Eccentric Regulating Bracket Plunger Spring Stop Screw
200614C	13491	Hook Gib Hinge Screw, for 247790
200625F	13486	Tension Stud with 204925, for 244062
200653C	13485	Presser Bar Lifter Hinge Screw
200842E	13484	Take-up (auxiliary) Screw
200907B	13488	Binder Tape Guide Screw, for 224719 to 224723 and 224726 to 224730
200975F	13485	Presser Bar Lifting Bracket Guide Screw
200984C	13491	Bobbin Case Tension Spring Regulating Screw, for 202533
200996C	13484	Lifting Bell Crank Stop Screw, for 208582
200997C	13487	Needle Bar and Needle Plate Carrier Frame Hinge Screw Stud Bushing Position Screw, for 208549
200998C	13487	Needle Bar and Needle Plate Carrier Frame Hinge Screw Stud
201012C	13484	Lifting Bell Crank Driving Crank Position Screw, for 208553
201014C	13482	Feed Driving Eccentric Regulating Bracket Hinge Screw, for 224515
201014C	13482	Feed Driving Eccentric Regulating Bracket Stop Screw, for 224515

NUMERICAL LIST OF PARTS

No.	Plate	Name
201015F	13489	Vibrating Presser Foot Pinch Screw, for 224708
201018C	13482	Hook Shaft Connection Belt Pulley Set Screw, for 202323 and 224516
201387F	13489	Needle Plate Screw
201499H	16615	Bobbin Winder Tension Stud, for 225461
201525E	13482	Feed Driving Eccentric Regulating Bracket Hinge Screw Nut, for 224515
201525E	13482	Feed Driving Eccentric Regulating Bracket Stop Screw Nut, for 224515
201531E	13488	Binder Swing Base Hinge Screw Nut, for 224719 to 224723 and 224726 to 224730
201562	13488	Binder Head Thumb Nut, for 224719 to 224723 and 224726 to 224730
201572H	16615	Bobbin Winder Tension Stud Thumb Nut, for 225462
201572H	13486	Tension Thumb Nut, for 244062
202005	13487	Arm Screw Washer
*202056	-----	Bobbin Case Latch Pin, for 202533
202091	13486	Thread Retainer Sleeve, for 204059
202092	13486	" " Spring, for 204059
202135	13487	Face Plate Position Pin, for 208521
202244	13481	Arm Shaft Bushing (back) Oil Packing (wick), for 240802
202244	13481	Arm Shaft Bushing (front) Oil Packing (wick), for 207080
202248	13481	Arm Cap Screw Washer
202252	-----	" Shaft Connection Belt Pulley with 200327C, 200602C and two 202253 (obsolete)
202253	13482	Arm Shaft Connection Belt Pulley Spring Flange, for 202252 and 224514
202254	13485	Take-up Lever Oil Leader Packing (wick)
202265	13491	Bobbin
202267	13491	" Case Latch, for 202533
202269	13491	" " Plunger, for 202533
202270	13491	" " Spring, for 202533
202277	16615	" Winder Frame Oil Packing (wick), for 225453
202277	13482	Feed Driving Connection Oil Packing (wick), for 208538
202277	13484	Lifting Bell Crank Driving Crank Oil Packing (wick)
202277	13487	Needle Bar and Needle Plate Carrier Frame Hinge Screw Stud Oil Packing (wick)
202277	13484	Take-up Lever Driving Stud Oil Packing (wick), for 208557
202277	13484	Vibrating Presser Bar Oil Packing (wick)
202301	13482	Feed Driving Eccentric Regulating Bracket Plunger

NUMERICAL LIST OF PARTS

No.	Plate	Name
*202311	-----	Feed Regulating Spindle Head, for 208540
202321	13482	Hook Shaft Bushing (back)
202322	13482	" " " (front)
202323	-----	" " Connection Belt Pulley with 202324 and two 201018C (obsolete)
202324	13482	Hook Shaft Connection Belt Pulley Spring Flange, for 202323 and 224516
202330	13484	Needle Bar Connecting Stud Oil Packing (wick), for 208552
202355	13485	Presser Bar Thumb Screw Thumb Set Screw Packing (brass)
202397	13484	Take-up (auxiliary)
202398	13484	" Lever, for 208582
202400	13484	" " Hinge Stud with 202423, for 208582
202404	13485	Tension Release Plunger
202407	13486	" Spring, for 244062
202410	13486	Thread Controller Spring, for 244062
202412	13481	" Guide
202415	13486	" "
202423	13484	Take-up Lever Hinge Stud Oil Packing (wick), for 202400
202443	13481	Feed Regulating Spindle Head Pin, for 208540
202478	16615	Bobbin Winder Stop Latch Trip Lever, for 259431
202530	-----	Arm Shaft Connection Belt (obsolete)
202533	13491	Bobbin Case complete, Nos. 200594C, 200984C, 202056, 202267, 202269, 202270, 202716 and 202806, for 247791
202595	13482	Feed Driving Eccentric Regulating Bracket Plunger Spring
202619	13481	Feed Regulating Spindle Head Position Pin, for 208540
202716	13491	Bobbin Case Tension Spring, for 202533
202784	13490	Treadle Chain Hook, for 228425
*202806	-----	Bobbin Case, for 202533
203089	13481	Arm Cap Spool Holder Base, for 203090
203090	13481	" " " " 203089 with 200079H and 204296, for 203092
203091	13481	Arm Cap, for 203092
203092	13481	Arm Cap and Spool Holder complete, Nos. 203090, 203091 and 200585H
203101	13491	Hook Oil Wick, for 247790
203172	13484	Needle Bar Crank Friction Washer
204058	13486	Thread Retainer Stud, for 204059
204059	13486	Thread Retainer complete, Nos. 202091, 202092 and 204058
204235	13487	Arm Position Pin
204296	13481	" Cap Spool Holder Wire, for 203090
204925	13486	Tension Stud Washer, for 200625F

NUMERICAL LIST OF PARTS

No.	Plate	Name
206751	-----	Hook Washer (obsolete)
206852	13491	" Gib, for 247790
207080	13481	Arm Shaft Bushing (front) with 202244
208313	13485	Presser Bar Lifter
208329	13488	Binder Tape Guide, for tapes or folded strips from 3/8 to 3/4 in., in steps of 1/32 in., for 224719 to 224723
208331	13482	Feed Driving Eccentric Regulating Bracket, for 224515
*208521	-----	Arm with 202135
208523	13481	" Shaft
208526	13484	Needle Bar with 200141F
208535	13487	Face Plate
208538	13482	Feed Driving Connection (bronze) with 202277
208539	13482	Feed Driving Connection Stud (eccen- tric) with 224530
208540	13481	Feed Regulating Spindle with 202311, 202443 and 202619 Nos. 208545 to 208547, for 208582
208545	13484	Lifting Bell Crank
208546	13484	" " " Driving Crank
208547	13484	" " " " Link
208549	13487	Needle Bar and Needle Plate Carrier Frame with 200362C, 200947C and 208550
208550	13487	Needle Bar and Needle Plate Carrier Frame Hinge Screw Stud Bushing (split), for 208549 Nos. 208551 to 208553, for 208582
208551	13484	Needle Bar Connecting Link
208552	13484	" " " Stud with 200086C and 202330
208553	13484	Needle Bar Crank with 200335C, 200374C, 200428C and 201012C
208555	13484	Presser Bar Lifting Bracket with 200054E, for 208582
208556	13485	Presser Bar Spring
208557	13484	Take-up Lever Driving Stud with 202277, for 208582
208558	13484	Take-up Lever Oil Guard with 223655 and 224572
208560	13485	Tension Release Slide Spring
208562	13484	Vibrating Presser Bar, for 208582
208563	13484	" " " Connecting Link, for 208582
208566	13485	Presser Bar with 200074F
208567	13485	" " Bushing
208568	13485	Take-up Lever Oil Leader
208569	13486	Thread Guide
208573	13481	Arm Shaft Counter Balance with 200335C
208574	13486	Thread Guide
208582	13484	Needle Bar Crank 208553 with 200996C, 202398, 202400, 208545 to 208547, 208551, 208552, 208555, 208557, 208562 and 208563

NUMERICAL LIST OF PARTS

No.	Plate	Name
210983	13487	Needle Bar and Needle Plate Carrier Frame Hinge Plate Position Pin
223655	13484	Take-up Lever Oiling Felt, for 208558
224392	13482	Hook Shaft Oil Packing (wick)
224513	13482	Arm Shaft Connection Belt
224514	13482	" " " " Pulley with 200327C, 200602C and two 202253, for 224515
224515	13482	Feed Driving Eccentric Regulating Bracket 208331 with 224514, two each 201014C and 201525E
224516	13482	Hook Shaft Connection Belt Pulley with 202324 and two 201018C
224527	13482	Oil Leader (brass) (for back hook shaft bearing)
224530	13482	Feed Driving Connection Stud Oil Pack- ing (wick), for 208539
224572	13484	Take-up Lever Oiling Felt Rivet, for 208558
*224701	-----	Bed (cylinder)
224702	13487	" " End Cover
224703	13489	Lifting Presser Foot, for 224708
224704	13489	Needle Plate, 50 needle hole, for needle sizes 14 and 15, for 224707
224705	13482	Needle Plate Slide Plate (adjustable)
224707	13487	Throat Plate, for 224704
224708	13489	Vibrating Presser Foot, 46 needle hole, with 201015F, for 224703
224709	13487	Foot Lifter Lifting Lever
224710	13488	Binder Head, .025 in. opening, for tapes or folded strips from 5/16 to 3/4 in., in steps of 1/32 in., for 224719 and 224726
224711	13488	Binder Head, .030 in. opening, for tapes or folded strips from 5/16 to 3/4 in., in steps of 1/32 in., for 224720 and 224727
224712	13488	Binder Head, .035 in. opening, for tapes or folded strips from 5/16 to 3/4 in., in steps of 1/32 in., for 224721 and 224728
224713	13488	Binder Head, .040 in. opening, for tapes or folded strips from 5/16 to 3/4 in., in steps of 1/32 in., for 224722 and 224729
224714	13488	Binder Head, .045 in. opening, for tapes or folded strips from 5/16 to 3/4 in., in steps of 1/32 in., for 224723 and 224730
224716	13488	Binder Tape Tension Plate with seven 228999, for 224719 to 224723 and 224726 to 224730
224717	13490	Tape Reel Bracket, for 224718
224718	13490	Tape Reel (6 in. diam.) complete, Nos. 224717 and 226200

NUMERICAL LIST OF PARTS

No.	Plate	Name
224719	13488	Binder complete, .025 in. opening, for tapes or folded strips from 3/8 to 3/4 in., in steps of 1/32 in., Nos. 200247F, 201531E, 208329, 224710, 224716, 224738, 225708, 230251, two each 200907B and 201562H
224720	13488	Binder complete, .030 in. opening, for tapes or folded strips from 3/8 to 3/4 in., in steps of 1/32 in., Nos. 200247F, 201531E, 208329, 224711, 224716, 224738, 225708, 230251, two each 200907B and 201562H
224721	13488	Binder complete, .035 in. opening, for tapes or folded strips from 3/8 to 3/4 in., in steps of 1/32 in., Nos. 200247F, 201531E, 208329, 224712, 224716, 224738, 225708, 230251, two each 200907B and 201562H
224722	13488	Binder complete, .040 in. opening, for tapes or folded strips from 3/8 to 3/4 in., in steps of 1/32 in., Nos. 200247F, 201531E, 208329, 224713, 224716, 224738, 225708, 230251, two each 200907B and 201562H
224723	13488	Binder complete, .045 in. opening, for tapes or folded strips from 3/8 to 3/4 in., in steps of 1/32 in., Nos. 200247F, 201531E, 208329, 224714, 224716, 224738, 225708, 230251, two each 200907B and 201562H
224725	13488	Binder Tape Guide, for 5/16 and 11/32 in. tapes or folded strips, for 224726 to 224730
224726	13488	Binder complete, .025 in. opening, for 5/16 and 11/32 in. tapes or folded strips, Nos. 200247F, 201531E, 224710, 224716, 224725, 224738, 225708, 230251, two each 200907B and 201562H
224727	13488	Binder complete, .030 in. opening, for 5/16 and 11/32 in. tapes or folded strips, Nos. 200247F, 201531E, 224711, 224716, 224725, 224738, 225708, 230251, two each 200907B and 201562H
224728	13488	Binder complete, .035 in. opening, for 5/16 and 11/32 in. tapes or folded strips, Nos. 200247F, 201531E, 224712, 224716, 224725, 224738, 225708, 230251, two each 200907B and 201562H
224729	13488	Binder complete, .040 in. opening, for 5/16 and 11/32 in. tapes or folded strips, Nos. 200247F, 201531E, 224713, 224716, 224725, 224738, 225708, 230251, two each 200907B and 201562H

NUMERICAL LIST OF PARTS

No.	Plate	Name
224730	13488	Binder complete, .045 in. opening, for 5/16 and 11/32 in. tapes or folded strips, Nos. 200247F, 201531E, 224714, 224716, 224725, 224738, 225708, 230251, two each 200907B and 201562H
224738	13488	Binder Swing Base with two 350255E, for 224719 to 224723 and 224726 to 224730
224741	13487	Needle Bar and Needle Plate Carrier Frame Hinge Plate
225368	16615	Bobbin Winder Pulley with 200380C, for 259431
225381	16615	Bobbin Winder Spindle, for 259431
225444	16615	" " Stop Latch, for 259431
225453	16615	Nos. 225453 to 225456, for 259431
225453	16615	Bobbin Winder Frame with 202277 and 259660
225454	16615	Bobbin Winder Frame Hinge Pin
225455	16615	" " " Spring
225456	16615	" " " Plunger
225458	16615	" " Stop Latch Thumb Lever, for 259431
225459	16615	Bobbin Winder Stop Latch Thumb Lever Hinge Stud, for 259431
225459	16615	Bobbin Winder Stop Latch Thumb Lever Joint Stud, for 259431
225461	16615	Bobbin Winder Tension Bracket with 201499H, for 225462
225462	16615	Bobbin Winder Tension Bracket complete, Nos. 13710, 201572H, 225461 and two 2102, for 259431
225498	13490	Screw Driver (7-1/4 in. long)
225554	13490	Wrench (steel)
225666	13490	Tape Reel Hub 230471 with 225980, for 226200
225708	13488	Binder Swing Base Spring, for 224719 to 224723 and 224726 to 224730
225980	13490	Tape Reel Hub Base, for 225666
226200	13490	" " (6 in. diam.) with 225666, for 224718
228026	16615	Bobbin Winder Tension Bracket Screw Washer, for 259431
228424	13490	Nos. 228424 to 228428, for 228429
228425	13490	Treadle with 200526C, for 228429
228426	13490	" Chain, 38 in. long with two 202784
228426	13490	Treadle Shaft
228427	13490	" Spring
228428	13490	" Stand with two wood screws 7/8 in., No. 12
228429	13490	Treadle, single foot (right) complete, Nos. 228424 to 228428
228476	13490	Screw Driver (Bobbin Case)
228999	13488	Binder Tape Tension Pin, for 224716
230251	13488	" Head Clamp Washer, for 224719 to 224723 and 224726 to 224730

NUMERICAL LIST OF PARTS

No.	Plate	Name
230471	13490	Tape Reel Hub, for 225666
233629	13485	Tension Release Slide
240802	13481	Arm Shaft Bushing (back) with 202244
241443	13486	Thread Controller Spring Stop
244048	13486	Tension Disc (back), for 244062
244049	13486	" " (front), for 244062
244061	13486	" Release Washer, for 244062
244062	13486	Tension complete, Nos. 200625F, 201572H, 202407, 202410, 244048, 244049, 244061 and 263106
244063	13481	Balance Wheel (disc) (belt groove 2-1/8 in. diam.) with 200328C and 200335C
244200	13491	Hook Shaft
247789	-----	" (sewing) with two 462AL, for 247790
247790	13491	Hook 247789 with 45761, 200145C, 200596F, 200614C, 203101 and 206852, for 247791
247791	13491	Hook and Bobbin Case complete, Nos. 202533 and 247790
259428	16615	Nos. 259428 to 259430, for 259431
259429	16615	Bobbin Winder Brake (leather)
259430	16615	" " " Clamp
259431	16615	" " and Tension Bracket Base
259431	16615	Universal Bobbin Winder complete, Nos. 200056E, 200082D, 200113F, 200299H, 202478, 225368, 225381, 225444, 225453 to 225456, 225458, 225462, 228026, 259428 to 259430, two each 225459 and wood screws 3/4 in., No. 12, R.H.B.
259660	16615	Bobbin Winder Frame Oil Well Washer, for 225453
263106	13486	Tension Spring Washer, for 244062
350255E	13488	Binder Head Screw Stud, for 224738
350308C	13487	Needle Bar and Needle Plate Carrier Frame Hinge Screw

13482 - 1/2

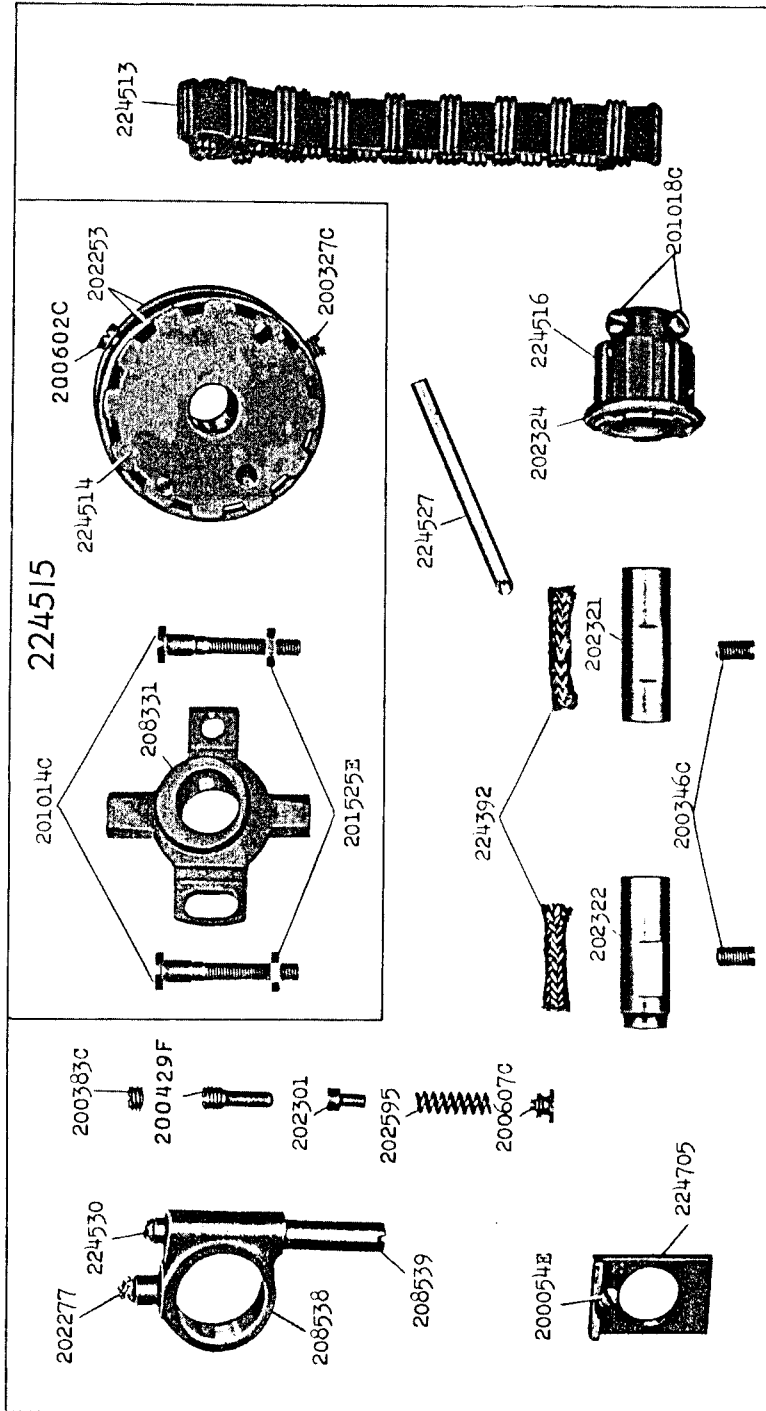

13484 - 1/2

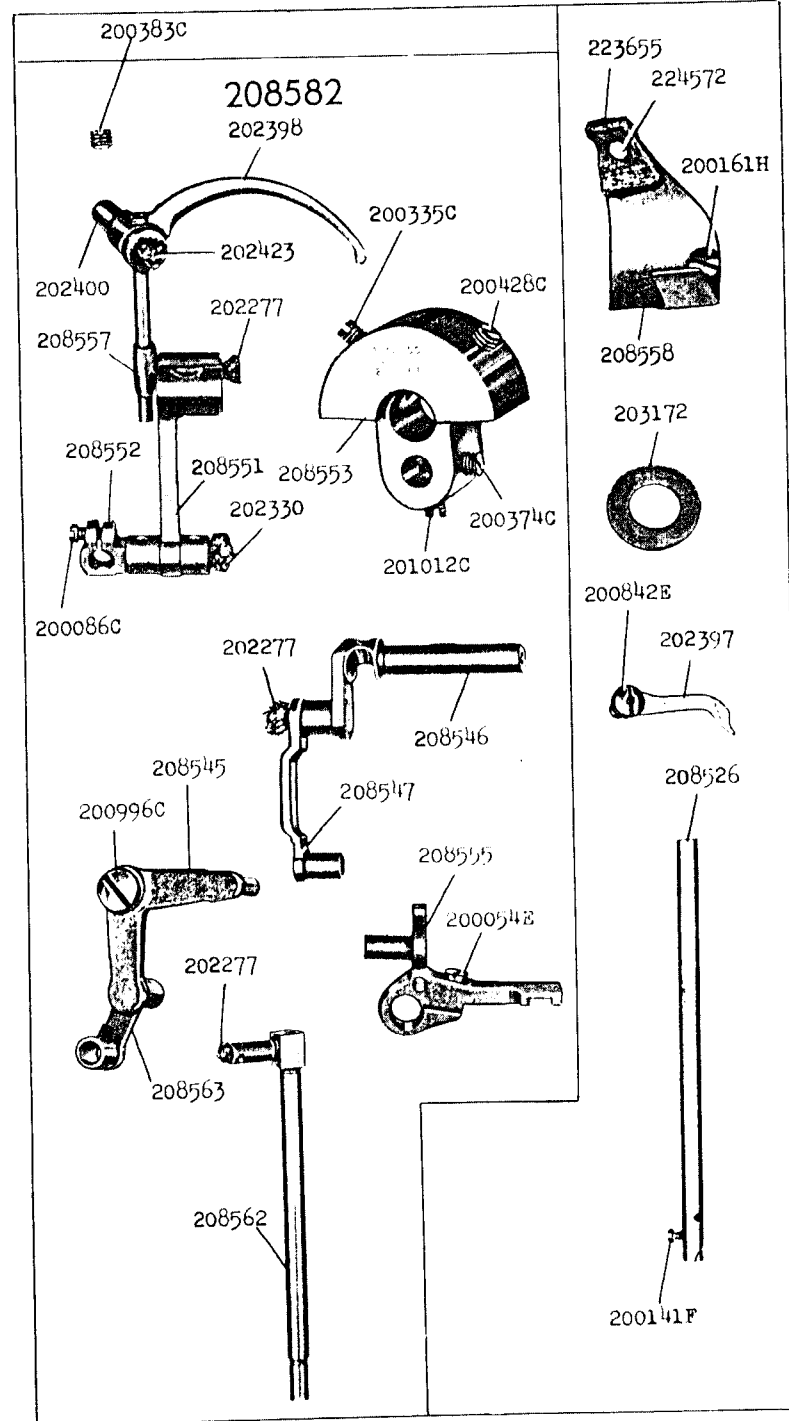

13485 - 3/4

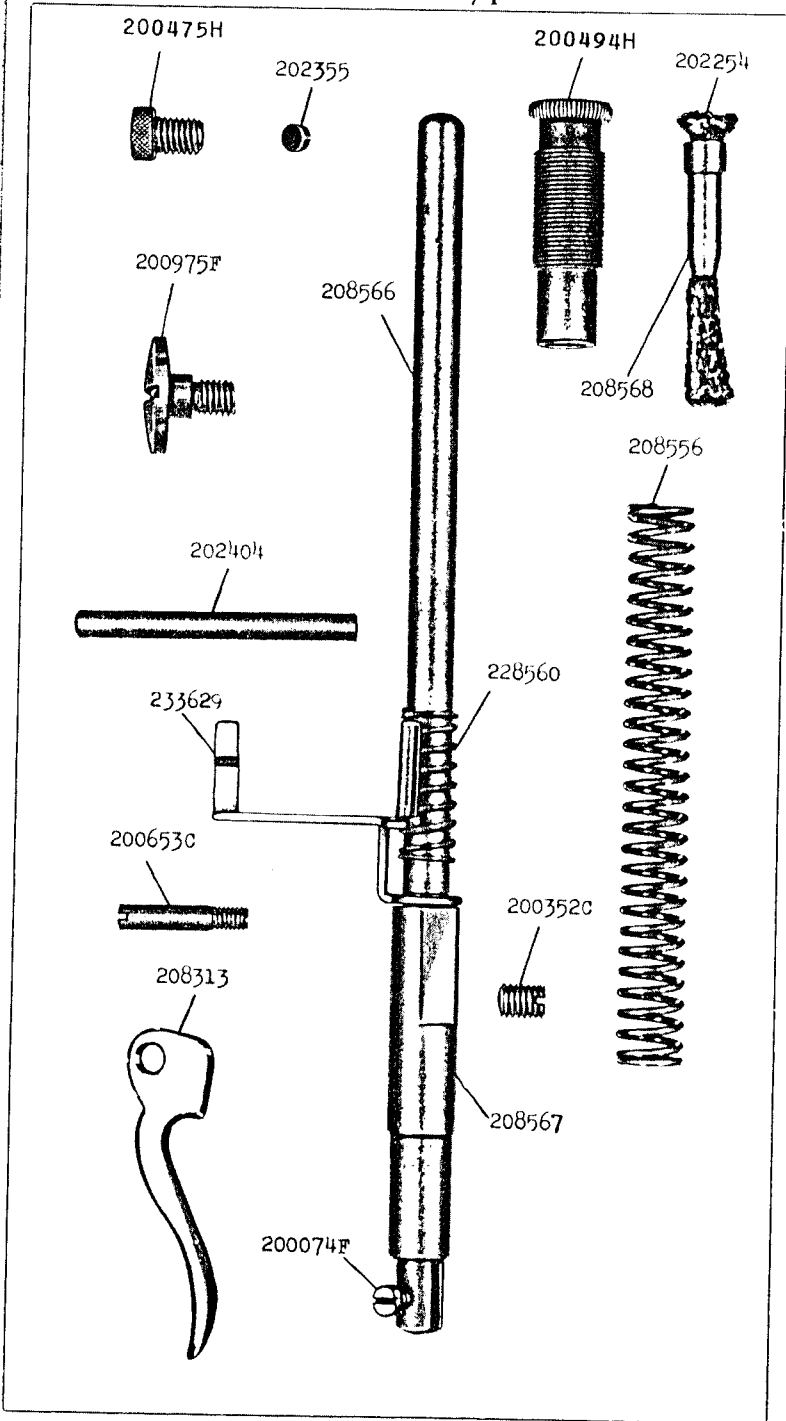

13486 - 2/3

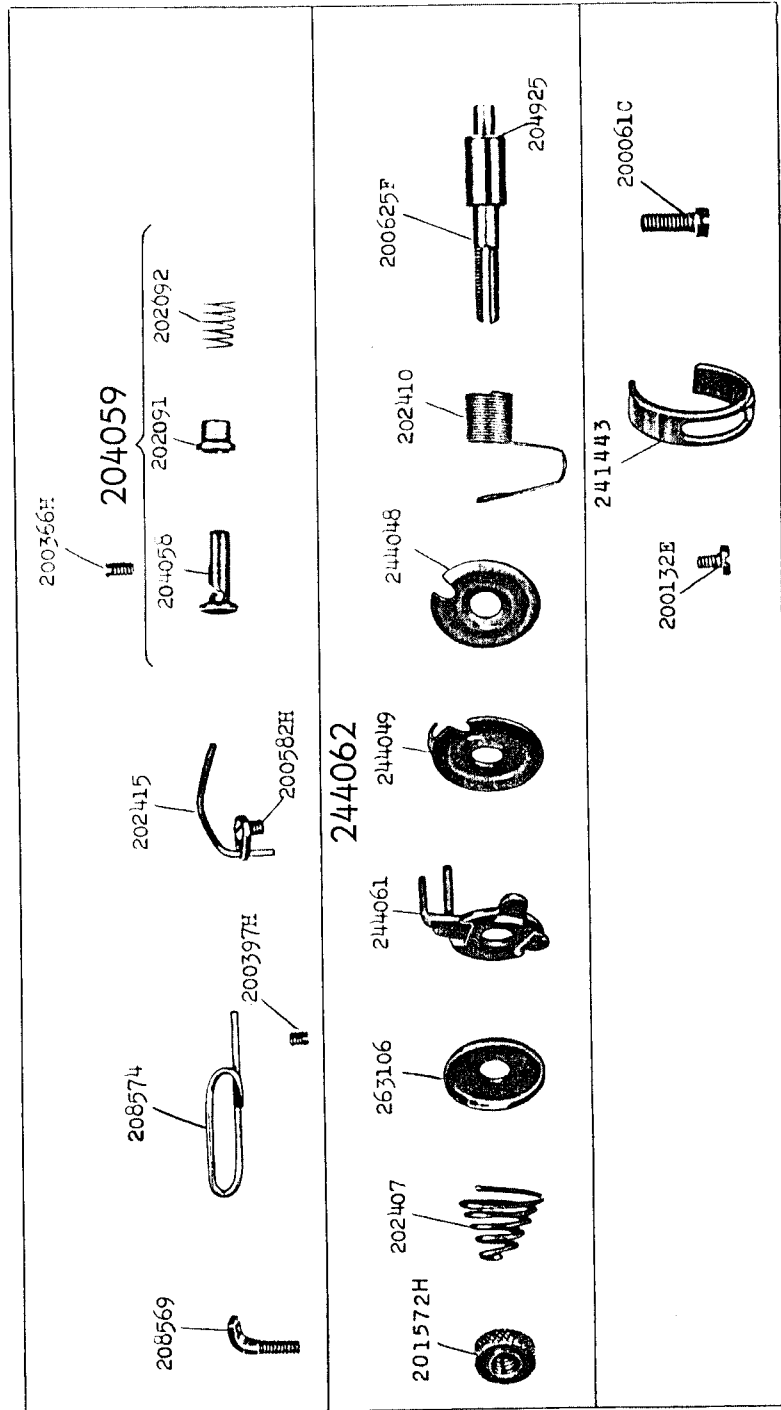

13487 - 3/8

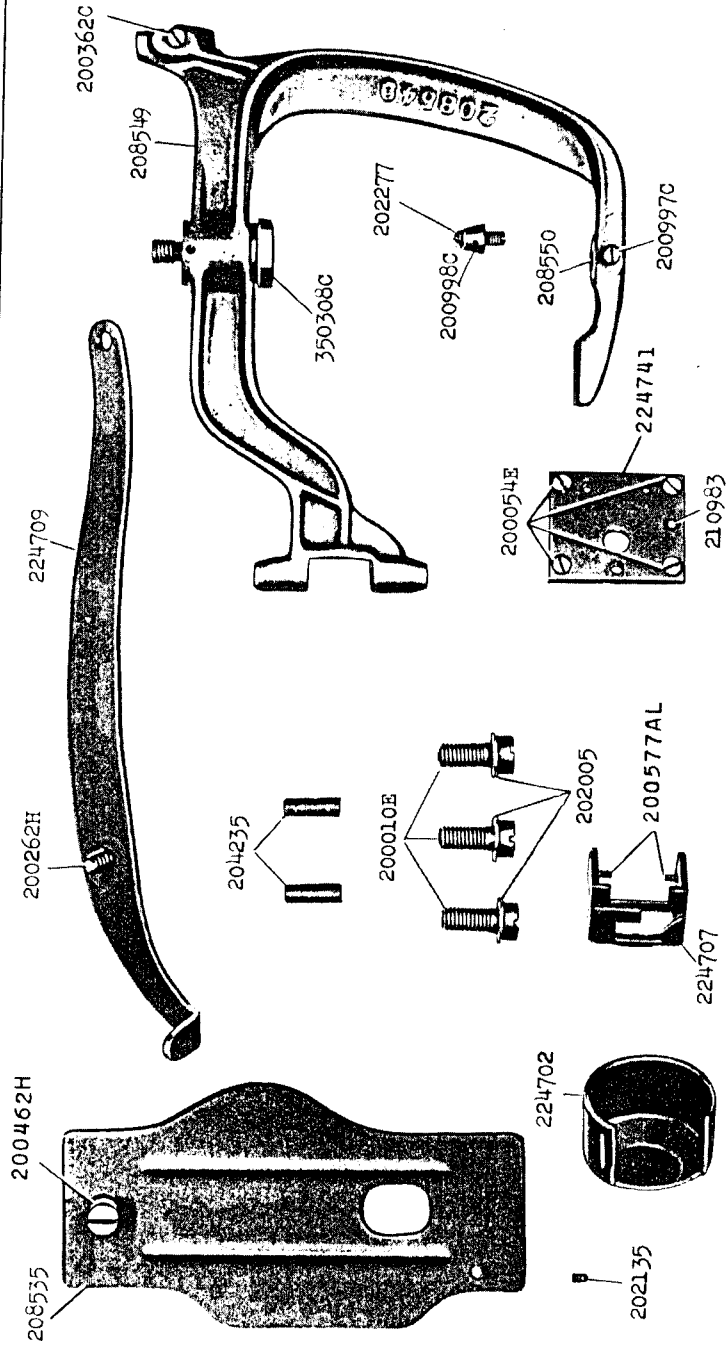

13488 - 5/8

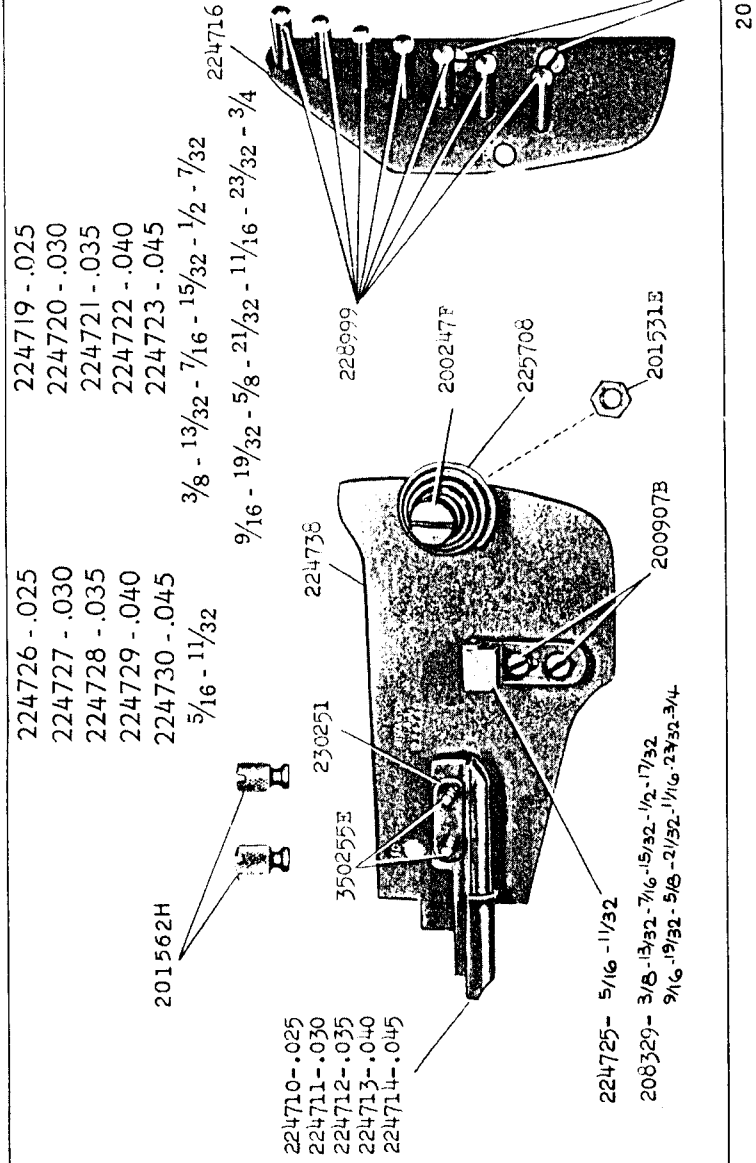

- 224719 - .025
- 224720 - .030
- 224721 - .035
- 224722 - .040
- 224723 - .045

- 3/8 - 13/32 - 7/16 - 15/32 - 1/2 - 7/32
- 9/16 - 19/32 - 5/8 - 21/32 - 11/16 - 23/32 - 3/4

- 224726 - .025
- 224727 - .030
- 224728 - .035
- 224729 - .040
- 224730 - .045

- 5/16 - 11/32

- 224710 - .025
- 224711 - .030
- 224712 - .035
- 224713 - .040
- 224714 - .045

- 224725 - 5/16 - 11/32

- 208329 - 3/8 - 13/32 - 7/16 - 15/32 - 1/2 - 17/32
- 9/16 - 19/32 - 5/8 - 21/32 - 11/16 - 23/32 - 3/4

200577AL

13489

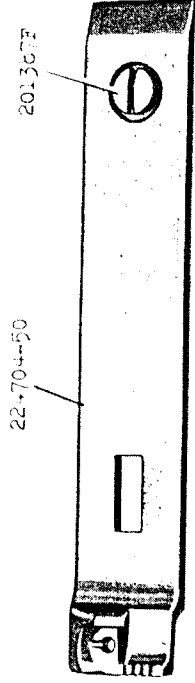
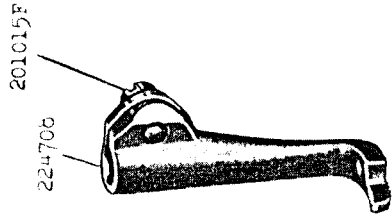
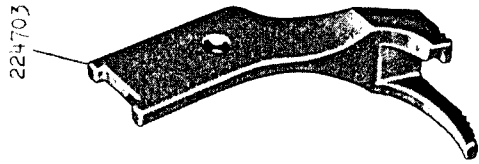

Feld

13490 - 1/4



228476

120342

120343

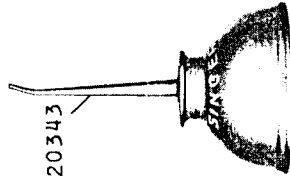

200040H

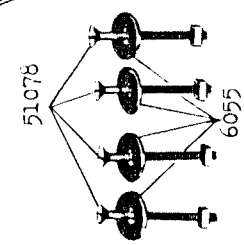

224718

226200

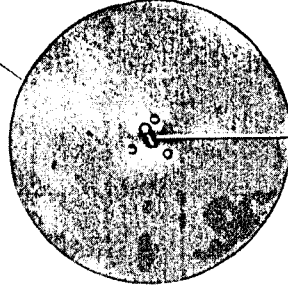

225666

230471

225980



224717

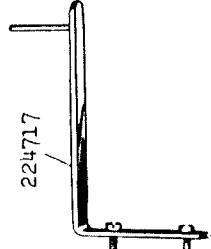

228429

202784

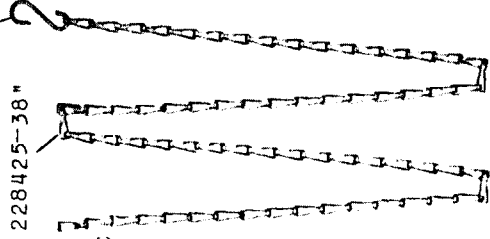

228424

200526C

228427

228426

228428

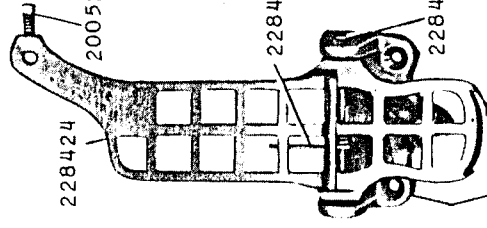

13491 - 2/3

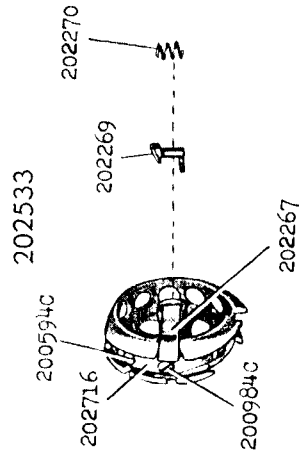
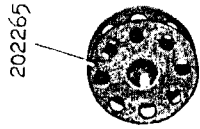

247791



247790

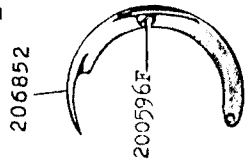

206852

200145C

203101

200614C

247789

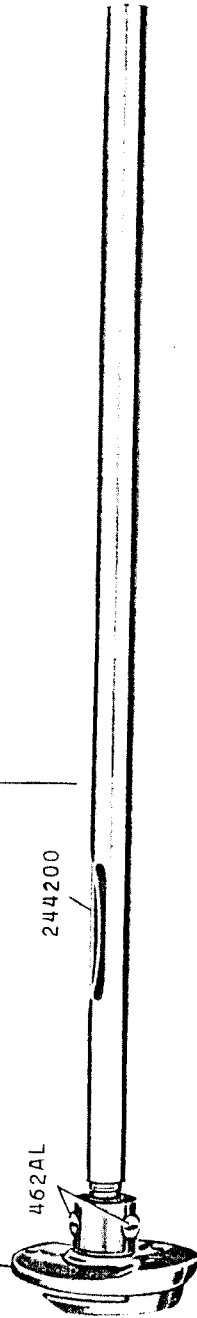

16615 - 1/2

259431

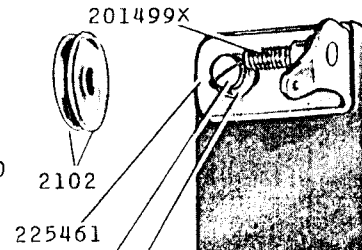
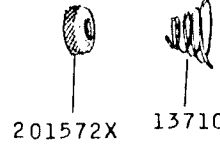

225462

200082D
228026

259430

225456

225455

