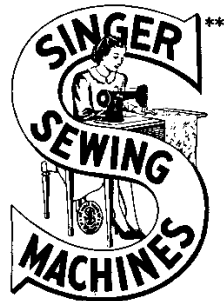


Singer 11-1	Singer 11-14
Singer 11-2	Singer 11-15
Singer 11-3	Singer 11-16
Singer 11-4	Singer 11-17
Singer 11-5	Singer 11-18
Singer 11-6	Singer 11-19
Singer 11-7	Singer 11-20
Singer 11-8	Singer 11-21
Singer 11-9	Singer 11-22
Singer 11-11	Singer 11-23
Singer 11-12	Singer 11-24
Singer 11-13	Singer 11-25
Singer 11-26	

Form 8215  
Supersedes Form 7513  
April, 1915  
Printed in U. S. A.

# LIST OF PARTS



## MACHINES

Nos. 11-1 to 11-9 and  
11-11 to 11-26

---

\*\* A TRADE MARK OF  
**THE SINGER MANUFACTURING COMPANY**

## INSTRUCTIONS FOR OILING

To ensure easy running and prevent unnecessary wear of the parts which are in movable contact, the machine requires oiling and when in continuous use, "TYPE B" or "TYPE D" OIL, sold only by Singer Sewing Machine Company, should be applied at least twice each day to all oil holes marked "OIL", as instructed in Form 8261.

"TYPE D" OIL is stainless.

COPYRIGHT, 1915, BY THE SINGER MANUFACTURING CO.

## INDEX

	PAGE
ACCESSORIES.....	97
BOBBIN WINDERS.....	98
COLUMN STAND.....	99
DRIVING ATTACHMENTS.....	100, 101
FOOT LIFTER PARTS.....	102
MACHINE No. 11-1.....	7
"    "    11-2.....	12
"    "    11-3.....	17
"    "    11-4.....	24
"    "    11-5.....	30
"    "    11-6.....	30
"    "    11-7.....	31
"    "    11-8.....	35
"    "    11-9.....	40
"    "    11-11.....	41
"    "    11-12.....	46
"    "    11-13.....	47
"    "    11-14.....	52
"    "    11-15.....	52
"    "    11-16.....	59
"    "    11-17.....	65
"    "    11-18.....	66
"    "    11-19.....	72
"    "    11-20.....	77
"    "    11-21.....	78
"    "    11-22.....	82
"    "    11-23.....	84
"    "    11-24.....	89
"    "    11-25.....	97
"    "    11-26.....	97
NUMERICAL LIST OF PARTS.....	115
OBSOLETE PARTS.....	107
STAND PARTS.....	102
TABLE BELT GUIDE.....	103
TRANSVERSE UNDER DRIVER.....	104
UNDER DRIVER.....	106

## INSTRUCTIONS FOR ORDERING

In ordering from this list, use **ONLY** the PART number in the **FIRST** column.

The number stamped on a Sewing Machine part is in every case the number of the single part only.

Every combination of parts sent out as such has its specific number, which, although not stamped on the parts, must be used when ordering the combination.

Each number always indicates the **SAME PART** in whatever list it appears, or for whatever machine.

The letters after some of the numbers indicate the style of finish only, as follows:

- A. Hardened, Polished and Plated.
- B. Polished and Plated.
- C. Hardened only.
- D. Polished only.
- E. Soft, not Polished.
- F. Hardened and Polished.
- G.
- H. Blued.
- J. Plated only.
- K. Hardened and Plated.
- L. Brass or Gilt.
- M. Oxidized.

These letters **MUST BE USED** when they appear in the list, and **AFTER** the number as in the list.

In this series

- 1 to 1500 and 50001 to 51500 are Screw Numbers.
- 1501 to 1800 are Nut Numbers.
- 1801 to 2000 are Roller Numbers.
- 2001 to 50000 and 52001 and upward are numbers of Machine Parts.

The figures in the second column refer only to the plates, illustrating the parts, and are **NOT TO BE USED** in ordering.

Parts marked with an asterisk (\*) are furnished only when repairs are made at factory.

## LIST OF PARTS COMPLETE FOR MACHINE NO. 11-1

FOR LEATHER, DROP FEED ACROSS THE ARM

OBSOLETE

NO.	PLATE	NAME
*11951	—	Arm with 65D and 14710
8702	1828	" Dowel Pin
338E	1853	" Screw
14539	1800	" Shaft
11954	1809	" " Bushing
446C	1852	" " " Set Screw
6804	1804	" " Gear with 453c
2117	1828	" " " Pin
453C	1824	" " " Set Screw
144D	1852	" " Screw
14710	1862	" Side Cover
65D	1851	" " " Hinge Screw
11957	1801	" " Wheel with two 446c
446C	1852	" " " Set Screw
6805	1804	" " " Shaft
6806	1804	" " " Gear with 453c
2117	1828	" " " " Pin
453C	1824	" " " " " Set Screw
144D	1852	" " " " " Screw
8708	1828	" Spool Pin
11241	1863	" " " Washer (cloth) per 100
11960	1801	Balance Wheel with two 354c
354C	1101	" " " Set Screw
14540	1802	Crank Connecting Rod with 14541 and two 145E
*14541	—	Crank Connecting Rod Cap
145E	1852	" " " " " Screw
565C	1851	" " " " " Hinge Screw
1513E	1824	" " " " " Nut
*14626	—	Cylinder, 3½ in. diam
3032	1803	Feed Cam with 446c
446C	1852	" " " Set Screw
3033	1813	" Connecting Link
375C	1813	" " " Hinge Screw
1518E	1813	" " " " " Nut
14544	1842	" Dog (left of needle)

NO.	PLATE	NAME
11966	1830	Feed Dog (right of needle)
11967	1813	" " Carrier
792c	1813	" " Screw
11969	1802	" Forked Connection
372c	1851	" " " Hinge Screw (lower)
375c	1813	Feed Forked Connection Hinge Screw (upper)
1518E	1813	Feed Forked Connection Hinge Screw Nut
11970	1813	Feed Regulator
58E	1813	" " Hinge Screw
283D	1813	" " Thumb Screw
11971	1801	" Rock Shaft
11972	—	Feed Rock Shaft complete, Nos. 11971 and 11974
4448	1828	Feed Rock Shaft Back Bearing Oil Tube
11974	1803	" " " Crank with 453c
2117	1828	" " " " Pin
453c	1824	" " " " Set Screw
11975	1805	Needle Bar
11976	1814	" " Connecting Link
375c	1813	" " " " Hinge Screw
1518E	1813	" " " " " " Nut
14547	1814	Needle Bar Connecting Stud with two 453c
453c	1824	Needle Bar Connecting Stud Set Screw
258E	1854	" " Screw Bushing
19702	1829	" Clamp with 680D and 11385
11385	1825	" " Gib
680D	1855	" " Thumb Screw
11497	1857	Oil Cup
11917	1857	" " Cover
9084	1828	" " " Hinge Pin
2205	1825	" " " Latch Spring
207F	1852	" " " " Screw
11919	1829	" " Thread Eyelet
8953	1826	" or Wax Stripper (felt)
8482	1826	" " " Washer (steel) for 11497
11918	1825	Oil or Wax Stripper Washer (steel) for 11917
207F	1852	Oil or Wax Stripper Washer Screw
11921	1857	Oil Cup complete, Nos. 2205, 8482, 9084, 11497, 11917 to 11919, two 8953 and three 207F

NO.	PLATE	NAME
135D	1852	Oil Cup Screw
12090	1804	Oscillating Rock Shaft with 11165
11164	1804	" " " Hinge Pin
435c	1852	" " " " " " Set Screw
11165	1826	Oscillating Rock Shaft Oil Pad
14548	1800	" " Shaft
13324	—	" " Crank
13416	1824	Oscillating Shaft Crank complete, Nos. 453c, 1513E, 5868 and 13324
2117	1828	Oscillating Shaft Crank Pin
453c	1824	" " " Set Screw
9119	1824	" " " Slide Block
5868	1824	Oscillating Shaft Crank Slide Block complete, Nos. 190D, 1054c, 5968 and 9119
190D	1824	Oscillating Shaft Crank Slide Block Cap Screw
5968	1824	Oscillating Shaft Crank Slide Block Cap Screw Washer
1054c	1824	Oscillating Shaft Crank Slide Block Screw Stud
1513E	1824	Oscillating Shaft Crank Slide Block Screw Stud Nut
11986	1805	Presser Bar
11988	1809	" " Guide Bracket with 175D and 446c
175D	1852	Presser Bar Guide Bracket Adjusting Screw
12066	1807	Presser Bar Guide Bracket Guide with 7393
164D	1852	Presser Bar Guide Bracket Guide Screw
446c	1852	" " " " Set Screw
11990	1806	" " Lifter
685D	1851	" " " Hinge Screw
7393	1828	" " " Stop Pin
258E	1854	" " Screw Bushing
11991	1805	" " Spring
14550	1842	" Foot (left of needle)
14549	1840	" " (right of needle)
176D	1852	" " Screw
252E	1854	Pressure Regulating Thumb Screw
1899	1840	Roller, 1¼ in., with 634D and 1528D
11994	1840	" Arm for 11992
14551	1842	" " " 14553
440F	1852	" " Adjusting Screw
1547D	1854	" " " " Nut
11995	1840	" " Bracket for 11992

NO.	PLATE	NAME
14552	1842	Roller Arm Bracket for 14553.....
316F	1852	" " " Screw Centre.....
1547D	1854	" " " " " Nut....
2205	1825	" " Lock Spring.....
207F	1852	" " " Screw.....
634D	1840	" Screw.....
1528D	1854	" " Nut.....
14553	1842	Roller Presser (left of needle) 1¼ in. roller, complete, Nos. 207F, 440F, 1899, 2205, 14551, 14552, two 316F and three 1547D.....
11992	1840	Roller Presser (right of needle) 1¼ in. roller, complete, Nos. 207F, 440F, 1899, 2205, 11994, 11995, two 316F and three 1547D.....
176D	1852	Roller Presser Screw.....
14535	1821	Shuttle Bobbin.....
12093	1820	" Cylinder.....
12000	1819	" " Hinge Pin.....
12001	1821	" " Latch.....
2027	1821	" " Pin.....
11854	1821	" " " Spring.....
590E	1821	" " " " Screw....
12094	1820	" Frame.....
773C	1820	" Tension Regulating Screw.....
12095	1820	" " Spring.....
12092	1820	Shuttle (cylinder) 2½ in. diam., complete, Nos. 590E, 773C, 2027, 11854, 12000, 12001, 12093 to 12095 and 14535.....
12006	1821	Shuttle Driver and Feed Lifting Cam....
2049	1828	" " " " " " Pin
14554	1818	" Race.....
141C	1852	" " Screw.....
12008	1814	Tension Bracket.....
190D	1824	" " Screw.....
8879	1827	" Friction Washer (cloth).....
11423	1826	" " " (steel).....
1560C	1854	" Regulating Thumb Nut.....
8905	1827	" " " " Washer..
411D	1855	" Screw Stud.....
11422	1827	" Spring.....
11044	1827	" Wheel.....
11420	—	Tension (wheel) complete, Nos. 411D, 1560C, 8905, 11044, 11422, 11423 and two 8879.....
11424	1829	Thread Eyelet (front of arm).....
11950	1829	" " (side of arm) for 11041....

NO.	PLATE	NAME
2102	1827	Thread Retaining Disc.....
1560C	1854	" " Regulating Thumb Nut
8905	1827	" " " " "
		Washer.....
686D	1855	Thread Retaining Screw Stud.....
2103	1827	" " Spring.....
11041	—	Thread Retainer complete, Nos. 686D, 1560C, 2103, 8905 and two 2102.....
12014	1808	Thread Take-up Cam with two 435C....
3012	1828	" " " Pin.....
435C	1852	" " " Set Screw.....
12016	1807	" " Lever with 1995.....
567D	1851	" " " Hinge Screw.....
1995	1889	" " " Roller and Screw Stud with 1518E.....
1518E	1813	Thread Take-up Lever Roller and Screw Stud Nut.....
11052	1827	Thread Take-up Spring.....
11431	1827	" " " Regulator Plate
190D	1824	" " " " "
		Adjusting Screw.....
12010	—	Throat Plate Body.....
12012	1830	" " Needle Hole Plate.....
237D	1851	" " " " " Screw...
12011	1830	Throat Plate complete for 11966, Nos. 237D, 12010 and 12012.....
12076	—	Throat Plate Body.....
14627	1878	" " Needle Hole Strip.....
401D	1851	" " " " " Screw...
14628	1878	Throat Plate complete for 14544, Nos. 12076, 14627 and two 401D.....
190D	1824	Throat Plate Screw.....

SINGER Needles should be used  
in SINGER Machines.  
These Needles and their Containers  
are marked with the  
Company's Trade Mark "SIMANCO.\*\*\*" 1

Needles in Containers marked  
"FOR SINGER MACHINES"  
are NOT **SINGER** made needles. 2

**LIST OF PARTS COMPLETE  
FOR  
MACHINE NO. 11-2**

FOR LEATHER. DROP FEED UP THE ARM

OBSOLETE

NO.	PLATE	NAME
*11951	—	Arm with 65d and 14710
8702	1828	" Dowel Pin
338E	1853	" Screw
11953	1800	" Shaft
11954	1809	" " Bushing
446c	1852	" " " Set Screw
6804	1804	" " Gear with 453c
2117	1828	" " " Pin
453c	1824	" " " Set Screw
144d	1852	" " Screw
14710	1862	" Side Cover
65d	1851	" " " Hinge Screw
11957	1801	" " Wheel with two 446c
446c	1852	" " " Set Screw
6805	1804	" " " Shaft
6806	1804	" " " Gear with 453c
2117	1828	" " " Pin
453c	1824	" " " Set Screw
144d	1852	" " " Screw
8708	1828	" Spool Pin
11241	1863	" " " Washer (cloth) per 100
11960	1801	Balance Wheel with two 354c
354c	1101	" " " Set Screw
11963	1802	Crank Connecting Rod with 11964 and two 158E
*11964	—	Crank Connecting Rod Cap
158E	1852	" " " " Screw
372c	1851	" " " Hinge Screw
1518E	1813	" " " " Nut
*11961	—	Cylinder, 3 1/2 in. diam
12024	1825	Feed Bell Crank
12025	1825	" " " Connecting Link
12026	1825	" " " " Stud
20E	1851	" " " Screw
11965	1812	" " " Slide
3032	1803	" Cam with 446c

NO.	PLATE	NAME
446c	1852	Feed Cam Set Screw
3033	1813	" Connecting Link
375c	1813	" " " Hinge Screw
1518E	1813	" " " " Nut
12027	1834	" Dog
12028	1825	" " Adjusting Piece
11967	1813	" " " Carrier
792c	1813	" " " Screw
11968	1812	" " Slide
12029	1825	" " Spring
190d	1824	" " " Screw
11969	1802	" Forked Connection
372c	1851	" " " Hinge S c r e w (lower)
375c	1813	Feed Forked Connection Hinge Screw (upper)
1518E	1813	Feed Forked Connection Hinge Screw Nut
11970	1813	Feed Regulator
58E	1813	" " Hinge Screw
283d	1813	" " Thumb Screw
11971	1801	" Rock Shaft
11972	—	Feed Rock Shaft complete, Nos. 11971 and 11974
11974	1803	Feed Rock Shaft Crank with 453c
2117	1828	" " " Pin
453c	1824	" " " Set Screw
11975	1805	Needle Bar
11976	1814	" " Connecting Link
375c	1813	" " " Hinge Screw
1518E	1813	" " " " Nut
14547	1814	Needle Bar Connecting Stud with two 453c
453c	1824	Needle Bar Connecting Stud Set Screw
258E	1854	" " Screw Bushing
19702	1829	" Clamp with 680d and 11385
11385	1825	" " Gib
680d	1855	" " Thumb Screw
11387	1857	Oil Cup
11917	1857	" " Cover
9084	1828	" " " Hinge Pin
2205	1825	" " " Latch Spring
207F	1852	" " " " Screw
11919	1829	" " Thread Eyelet
8953	1826	" or Wax Stripper (felt)

NO.	PLATE	NAME
8482	1826	Oil or Wax Stripper Washer (steel) for 11387.....
11918	1825	Oil or Wax Stripper Washer (steel) for 11917.....
207F	1852	Oil or Wax Stripper Washer Screw.....
11920	1857	Oil Cup complete, Nos. 2205, 8482, 9084, 11387, 11917 to 11919, two 8953 and three 207F.....
135D	1852	Oil Cup Screw.....
11983	1804	Oscillating Rock Shaft with 197E, 2170, 11984, 14657 and two 11985.....
2170	1826	Oscillating Rock Shaft Oil Pad.....
197E	1852	" " " " " Screw....
304C	1852	" " " " " Screw Centre....
1513E	1824	" " " " " Nut.....
11984	1815	" " " " " Steel Plate (left)...
14657	1815	" " " " " " (right)
11985	1828	" " " " " Rivet.....
11979	1800	" " Shaft.....
11981	1824	" " Crank with 453c and 1807.....
2117	1828	Oscillating Shaft Crank Pin.....
1807	1824	" " " " " Roller and Stud..
453c	1824	" " " " " Set Screw.....
11986	1805	Presser Bar.....
11988	1809	" " Guide Bracket with 175D and 446c.....
175D	1852	Presser Bar Guide Bracket Adjusting Screw.....
12066	1807	Presser Bar Guide Bracket Guide with 7393.....
164D	1852	Presser Bar Guide Bracket Guide Screw..
446c	1852	" " " " " Set Screw....
11990	1806	" " " " " Lifter.....
685D	1851	" " " " " Hinge Screw.....
7393	1828	" " " " " Stop Pin.....
258E	1854	" " " " " Screw Bushing.....
11991	1805	" " " " " Spring.....
14567	1844	" " " " " Foot (left of needle).....
176D	1852	" " " " " Screw.....
252E	1854	Pressure Regulating Thumb Screw.....
1899	1840	Roller, 1¼ in., with 634D and 1528D.....
12031	1844	" " " " " Arm.....
440F	1852	" " " " " Adjusting Screw.....
1547D	1854	" " " " " Nut.....
12032	1844	" " " " " Bracket.....
316F	1852	" " " " " Screw Centre.....

NO.	PLATE	NAME
1547D	1854	Roller Arm Bracket Screw Centre Nut..
2205	1825	" " " " " Lock Spring.....
176D	1852	" " " " " " Screw.....
1549D	1854	" " " " " " Nut.....
634D	1840	" " " " " " Screw.....
1528D	1854	" " " " " " Nut.....
12030	1844	Roller Presser, 1¼ in. roller, complete, Nos. 176D, 440F, 1549D, 1899, 2205, 12031, 12032, two 316F and three 1547D
176D	1852	Roller Presser Screw.....
14535	1821	Shuttle Bobbin.....
12019	1819	" " " " " Cylinder.....
12000	1819	" " " " " Hinge Pin.....
12020	1819	" " " " " Latch Spring.....
223D	1819	" " " " " " Screw....
12021	1819	" " " " " Frame.....
774c	1821	" " " " " Tension Regulating Screw.....
12022	1819	" " " " " Spring.....
12018	1819	Shuttle (cylinder) 2½ in. diam., complete, Nos. 223D, 774c, 12000, 12019 to 12022 and 14535.....
12023	1823	Shuttle Driver and Feed Lifting Cam....
2049	1828	" " " " " " " Pin.
12007	1816	" " " " " Race Ring.....
391c	1851	" " " " " " Screw.....
12008	1814	Tension Bracket.....
190D	1824	" " " " " " Screw.....
8879	1827	" " " " " Friction Washer (cloth).....
11423	1826	" " " " " (steel).....
1560c	1854	" " " " " Regulating Thumb Nut.....
8905	1827	" " " " " " " Washer..
411D	1855	" " " " " " Screw Stud.....
11422	1827	" " " " " " Spring.....
11044	1827	" " " " " " Wheel.....
11420	—	Tension (wheel) complete, Nos. 411D, 1560c, 8905, 11044, 11422, 11423 and two 8879.....
11424	1829	Thread Eyelet (front of arm).....
11950	1829	" " " " " (side of arm) for 11041....
2102	1827	" " " " " Retaining Disc.....
1560c	1854	" " " " " Regulating Thumb Nut
8905	1827	" " " " " " " " " " Washer.....
686D	1855	Thread Retaining Screw Stud.....
2103	1827	" " " " " " Spring.....
11041	—	Thread Retainer complete, Nos. 686D, 1560c, 2103, 8905 and two 2102.....



NO.	PLATE	NAME
12014	1808	Thread Take-up Cam with two 435c.....
3012	1828	" " " Pin.....
435c	1852	" " " Set Screw.....
12016	1807	" " " Lever with 1995.....
567D	1851	" " " Hinge Screw.....
1995	1889	" " " Roller and Screw Stud with 1518E.....
1518E	1813	Thread Take-up Lever Roller and Screw Stud Nut.....
11052	1827	Thread Take-up Spring.....
11431	1827	" " " Regulator Plate
190D	1824	" " " " " " Adjusting Screw.....
12033	—	Throat Plate Body.....
12012	1830	" " " Needle Hole Plate.....
237D	1851	" " " " " " Screw....
12034	1834	Throat Plate complete for 12027, Nos. 237D, 12012 and 12033.....
190D	1824	Throat Plate Screw.....

## LIST OF PARTS COMPLETE FOR MACHINE NO. 11-3

FOR LEATHER. DROP FEED ACROSS THE ARM. HAS  
ALTERNATING PRESSERS

### OBSOLETE

NO.	PLATE	NAME
*12036	—	Arm with 65D and 14710.....
8702	1828	" Dowel Pin.....
338E	1853	" Screw.....
12085	1800	" Shaft.....
11954	1809	" " Bushing.....
446c	1852	" " " Set Screw.....
6804	1804	" " " Gear with 453c.....
2117	1828	" " " Pin.....
453c	1824	" " " Set Screw.....
144D	1852	" " " Screw.....
14710	1862	" Side Cover.....
65D	1851	" " " Hinge Screw.....
11957	1801	" " " Wheel with two 446c.....
446c	1852	" " " Set Screw.....
6805	1804	" " " Shaft.....
6806	1804	" " " " " " Gear with 453c...
2117	1828	" " " " " " Pin.....
453c	1824	" " " " " " Set Screw....
144D	1852	" " " " " " Screw.....
8708	1828	" Spool Pin.....
11241	1863	" " " Washer (cloth)... per 100
11960	1801	Balance Wheel with two 354c.....
354c	1101	" " " Set Screw.....
12096	1802	Crank Connecting Rod with 14541 and two 145E.....
*14541	—	Crank Connecting Rod Cap.....
145E	1852	" " " " " " Screw.....
565c	1851	" " " " " " Hinge Screw.....
1513E	1824	" " " " " " Nut..
*14629	—	Cylinder, 3½ in. diam.....
3032	1803	Feed Cam with 446c.....
446c	1852	" " " Set Screw.....
3033	1813	" Connecting Link.....
375c	1813	" " " " " " Hinge Screw.....
1518E	1813	" " " " " " Nut..

NO.	PLATE	NAME
14512	1839	Feed Dog
11967	1813	" " Carrier
792c	1813	" " Screw
12097	1802	" Forked Connection
372c	1851	" " " Hinge Screw (lower)
375c	1813	Feed Forked Connection Hinge Screw (upper)
1518E	1813	Feed Forked Connection Hinge Screw Nut
12091	1813	Feed Regulator
58E	1813	" " Hinge Screw
254D	1813	" " Thumb Screw
12087	1801	" Rock Shaft
14630	—	Feed Rock Shaft complete, Nos. 12087 and 14631
4448	1828	Feed Rock Shaft Back Bearing Oil Tube
14631	1803	" " " Crank with 453c
2117	1828	" " " " Pin
453c	1824	" " " " Set Screw
11475	1805	Lifting Presser Bar
11476	1810	" " " Bell Crank
166D	1855	" " " " Hinge Cap Screw
1851	1851	Lifting Presser Bar Bell Crank Lifting Roller with 610D
610D	1852	Lifting Presser Bar Bell Crank Lifting Roller Screw
1518E	1813	Lifting Presser Bar Bell Crank Lifting Roller Screw Nut
2718	1826	Lifting Presser Bar Bell Crank Lifting Roller Screw Nut Washer
11478	1810	Lifting Presser Bar Bracket with two 145F
145F	1852	" " " " Clamping Screw
11909	1806	Lifting Presser Bar Lifter with 8761 and 8763
8760	1826	Lifting Presser Bar Lifter Friction Washer
16D	1851	" " " " Hinge Screw
8761	1828	" " " " Stop Pin
11907	1806	" " " Lifting Link
166D	1855	" " " " " Cap Screw
8763	1828	Lifting Presser Bar Lifting Link Hinge Stud
7958	1828	Lifting Presser Bar Lifting Link Hinge Stud Pin

NO.	PLATE	NAME
8765	1826	Lifting Presser Bar Lifting Link Hinge Stud Washer
11479	1810	Lifting Presser Bar Rock Shaft
11480	1810	" " " " " Adjusting Arm with 190D
2117	1828	Lifting Presser Bar Rock Shaft Adjusting Arm Pin
190D	1824	Lifting Presser Bar Rock Shaft Adjusting Arm Set Screw
11481	1810	Lifting Presser Bar Rock Shaft Bracket
2002	1828	" " " " " " Dowel Pin (lower)
4389	1828	Lifting Presser Bar Rock Shaft Bracket Dowel Pin (upper)
123E	1852	Lifting Presser Bar Rock Shaft Bracket Screw
11484	1810	Lifting Presser Bar Rock Shaft Crank with 453c and 1850
2117	1828	Lifting Presser Bar Rock Shaft Crank Pin
1850	1854	Lifting Presser Bar Rock Shaft Crank Roller and Stud
453c	1824	Lifting Presser Bar Rock Shaft Crank Set Screw
11486	1810	Lifting Presser Bar Rock Shaft Eccentric Strap with two each 141F and 1528D
141F	1852	Lifting Presser Bar Rock Shaft Eccentric Strap Adjusting Screw
1528D	1854	Lifting Presser Bar Rock Shaft Eccentric Strap Adjusting Screw Nut
608c	1851	Lifting Presser Bar Rock Shaft Eccentric Strap Hinge Screw
1518E	1813	Lifting Presser Bar Rock Shaft Eccentric Strap Hinge Screw Nut
11487	1825	Lifting Presser Bar Rock Shaft Eccentric Strap Hinge Screw Slide
11488	1826	Lifting Presser Bar Rock Shaft Eccentric Strap Hinge Screw Slide Washer
258E	1854	Lifting Presser Bar Screw Bushing
11489	1810	" " " Sleeve (lower)
11490	1810	" " " " (upper)
11491	—	" " " " " 11490 with 11492
11492	1825	Lifting Presser Bar Sleeve (upper) Cap
11493	1801	" " " Spring (flat)
11494	1810	" " " " Bracket
138E	1101	" " " " " Screw

NO.	PLATE	NAME
11495	1829	Lifting Presser Bar Spring Bracket Thread Eyelet.....
190D	1824	Lifting Presser Bar Spring Bracket Thread Eyelet Screw.....
2002	1828	Lifting Presser Bar Spring Guide Pin....
14538	1839	" " Foot with 211F.....
2049	1828	" " " Pin.....
211F	1852	" " " Set Screw.....
11380	1805	Needle Bar.....
11381	1814	" " Connecting Link.....
566c	1851	" " " " Hinge Screw
1513E	1824	" " " " " " Nut.....
11383	1814	Needle Bar Connecting Stud with two 445c.....
445c	1852	Needle Bar Connecting Stud Set Screw..
258E	1854	" " Screw Bushing.....
19702	1829	" Clamp with 680D and 11385.....
11385	1825	" " Gib.....
680D	1855	" " Thumb Screw.....
11497	1857	Oil Cup.....
11917	1857	" " Cover.....
9084	1828	" " " Hinge Pin.....
2205	1825	" " " Latch Spring.....
207F	1852	" " " " " Screw.....
11919	1829	" " Thread Eyelet.....
8953	1826	" or Wax Stripper (felt).....
8482	1826	" " " " Washer (steel) for 11497.....
11918	1825	Oil or Wax Stripper Washer (steel) for 11917.....
207F	1852	Oil or Wax Stripper Washer Screw.....
11921	1857	Oil Cup complete, Nos. 2205, 8482, 9084, 11497, 11917 to 11919, two 8953 and three 207F.....
135D	1852	Oil Cup Screw.....
12090	1804	Oscillating Rock Shaft with 11165.....
11164	1804	" " " Hinge Pin.....
435c	1852	" " " " " " S e t Screw.....
11165	1826	Oscillating Rock Shaft Oil Pad.....
14632	1800	" Shaft.....
12088	—	" Crank.....
14633	1823	Oscillating Shaft Crank complete, Nos. 453c, 1513E, 5868 and 12088.....
2117	1828	Oscillating Shaft Crank Pin.....
453c	1824	" " " Set Screw.....

NO.	PLATE	NAME
9119	1824	Oscillating Shaft Crank Slide Block....
5868	1824	Oscillating Shaft Crank Slide Block complete, Nos. 190D, 1054c, 5968 and 9119.
190D	1824	Oscillating Shaft Crank Slide Block Cap Screw.....
5968	1824	Oscillating Shaft Crank Slide Block Cap Screw Washer.....
1054c	1824	Oscillating Shaft Crank Slide Block Screw Stud.....
1513E	1824	Oscillating Shaft Crank Slide Block Screw Stud Nut.....
609D	1855	Pressure Regulating Thumb Screw.....
14535	1821	Shuttle Bobbin.....
12093	1820	" Cylinder.....
12000	1819	" " Hinge Pin.....
12001	1821	" " Latch.....
2027	1821	" " " Pin.....
11854	1821	" " " Spring.....
590E	1821	" " " " Screw....
12094	1820	" Frame.....
773c	1820	" Tension Regulating Screw.....
12095	1820	" " Spring.....
12092	1820	Shuttle (cylinder) 2½ in. diam., complete, Nos. 590E, 773c, 2027, 11854, 12000, 12001, 12093 to 12095 and 14535.....
12006	1821	Shuttle Driver and Feed Lifting Cam....
2049	1828	" " " " " " Pin.
14554	1818	" Race.....
141c	1852	" Screw.....
11502	1809	Tension Bracket and Vibrating Presser Bar Cap with 11424.....
11501	—	Tension Bracket and Vibrating Presser Bar Cap complete, Nos. 122D, 9525, 11502, 11506, 11936, 11937, 12042 and two 190D.....
159F	1852	Tension Bracket and Vibrating Presser Bar Cap Screw (left).....
145F	1852	Tension Bracket and Vibrating Presser Bar Cap Screw (right).....
8879	1827	Tension Friction Washer (cloth).....
11423	1826	" " " (steel).....
1560c	1854	" Regulating Thumb Nut.....
8905	1827	" " " " Washer..
607D	1855	" Screw Stud.....
122D	1852	" " Clamping Screw.....
8791	1827	" Spring.....
11044	1827	" Wheel.....

NO.	PLATE	NAME
12042	—	Tension (wheel) complete, Nos. 607D, 1560c, 8791, 8905, 11044, 11423 and two 8879.....
11424	1829	Thread Eyelet (front of arm) for 11502..
11950	1829	“ “ (side of arm) for 11503....
2102	1827	“ Retaining Disc.....
1560c	1854	“ “ Regulating Thumb Nut
8905	1827	“ “ “ “ “
		Washer.....
606D	1855	Thread Retaining Screw Stud.....
2103	1827	“ “ Spring.....
11503	—	Thread Retainer complete, Nos. 606D, 1560c, 2103, 8905 and two 2102.....
12044	1808	Thread Take-up Cam with two 434c....
8873	1828	“ “ “ Pin.....
434c	1852	“ “ “ Set Screw.....
11845	1807	“ “ Lever with 1995.....
567D	1851	“ “ “ Hinge Screw.....
1995	1889	“ “ “ Roller and Screw
		Stud with 1518E.....
1518E	1813	Thread Take-up Lever Roller and Screw
		Stud Nut.....
11506	1827	Thread Take-up Spring.....
11936	1827	“ “ “ Regulator Plate
190D	1824	“ “ “ “ “
		Adjusting Screw.....
11937	1829	Thread Take-up Spring Staple.....
9525	1826	“ “ “ “ Washer....
14634	—	Throat Plate Body.....
14514	1879	“ “ Needle Hole Strip, round
		needle hole.....
401D	1851	Throat Plate Needle Hole Strip Screw...
14515	1879	Throat Plate complete for 14512, Nos. 14514, 14634 and two 401D.....
14634	—	Throat Plate Body.....
12047	1836	“ “ Needle Hole Strip, oblong
		needle hole.....
401D	1851	Throat Plate Needle Hole Strip Screw...
14635	1839	Throat Plate complete for 14512, Nos. 12047, 14634 and two 401D.....
190D	1824	Throat Plate Screw.....
11508	1809	Vibrating Presser Bar.....
11509	1826	“ “ “ Cushion (rawhide)..
233D	1852	“ “ “ “ Screw.....
14601	1810	“ “ “ Hinge Bracket with
		145F.....

NO.	PLATE	NAME
145F	1852	Vibrating Presser Bar Hinge Bracket
		Adjusting Screw.....
164D	1852	Vibrating Presser Bar Hinge Cap Screw
41544	1826	“ “ “ “ “
		Washer.....
11512	1825	Vibrating Presser Bar Spring.....
11939	1829	“ “ “ “ Adjusting
		Staple.....
190D	1824	Vibrating Presser Bar Spring Adjusting
		Staple Screw.....
223D	1819	Vibrating Presser Bar Spring Screw.....
11513	1839	“ “ Foot.....
191c	1852	“ “ “ Screw.....



NO.	PLATE	NAME
11906	1806	Lifting Presser Bar Lifting Link.....
353c	1854	" " " " " C a p Screw.....
8763	1828	Lifting Presser Bar Lifting Link Hinge Stud.....
795S	1828	Lifting Presser Bar Lifting Link Hinge Stud Pin.....
8765	1826	Lifting Presser Bar Lifting Link Hinge Stud Washer.....
258E	1854	Lifting Presser Bar Screw Bushing.....
11409	1805	" " " Spring.....
11465	1815	" " " " Bracket with 353c.....
353c	1854	Lifting Presser Bar Spring Bracket Set Screw.....
11466	1826	Lifting Presser Bar Spring Bracket Set Screw Washer.....
11380	1805	Needle Bar.....
11381	1814	" " Connecting Link.....
566c	1851	" " " " Hinge Screw
1513E	1824	" " " " " "
		Nut.....
11383	1814	Needle Bar Connecting Stud with two 445c.....
445c	1852	Needle Bar Connecting Stud Set Screw..
258E	1854	" " Screw Bushing.....
19702	1829	" Clamp with 680D and 11385.....
11385	1825	" " Gib.....
680D	1855	" " Thumb Screw.....
11497	1857	Oil Cup.....
11917	1857	" " Cover.....
9084	1828	" " Hinge Pin.....
2205	1825	" " Latch Spring.....
207F	1852	" " " " Screw.....
11919	1829	" " Thread Eyelet.....
8953	1826	" or Wax Stripper (felt).....
8482	1826	" " " " Washer (steel) for 11497.....
11918	1825	Oil or Wax Stripper Washer (steel) for 11917.....
207F	1852	Oil or Wax Stripper Washer Screw.....
11921	1857	Oil Cup complete, Nos. 2205, 8482, 9084, 11497, 11917 to 11919, two 8953 and three 207F.....
135D	1852	Oil Cup Screw.....
12090	1804	Oscillating Rock Shaft with 11165.....
11164	1804	" " " Hinge Pin.....

NO.	PLATE	NAME
435c	1852	Oscillating Rock Shaft Hinge Pin Set Screw.....
11165	1826	Oscillating Rock Shaft Oil Pad.....
14632	1800	" Shaft.....
12088	---	" " Crank.....
14633	1823	Oscillating Shaft Crank complete, Nos. 453c, 1513E, 5868 and 12088.....
2117	1828	Oscillating Shaft Crank Pin.....
453c	1824	" " " Set Screw.....
9119	1824	" " " Slide Block.....
5868	1824	Oscillating Shaft Crank Slide Block com- plete, Nos. 190D, 1054c, 5968 and 9119.
190D	1824	Oscillating Shaft Crank Slide Block Cap Screw.....
5968	1824	Oscillating Shaft Crank Slide Block Cap Screw Washer.....
1054c	1824	Oscillating Shaft Crank Slide Block Screw Stud.....
1513E	1824	Oscillating Shaft Crank Slide Block Screw Stud Nut.....
252E	1854	Pressure Regulating Thumb Screw.....
14535	1821	Shuttle Bobbin.....
12093	1820	" Cylinder.....
12000	1819	" " Hinge Pin.....
12001	1821	" " Latch.....
2027	1821	" " " Pin.....
11854	1821	" " " Spring.....
590E	1821	" " " " Screw.....
12094	1820	" Frame.....
773c	1820	" Tension Regulating Screw.....
12095	1820	" " Spring.....
12092	1820	Shuttle (cylinder) 2½ in. diam., complete, Nos. 590E, 773c, 2027, 11854, 12000, 12001, 12093 to 12095 and 14535.....
12006	1821	Shuttle Driver and Feed Lifting Cam
2049	1828	" " " " " " Pin.....
14554	1818	Shuttle Race.....
141c	1852	" " Screw.....
11421	1814	Tension Bracket.....
190D	1824	" " Screw.....
8879	1827	" Friction Washer (cloth).....
11423	1826	" " " (steel).....
1560c	1854	" Regulating Thumb Nut.....
8905	1827	" " " Washer..
411D	1855	" Screw Stud.....
11422	1827	" Spring.....

NO.	PLATE	NAME
11044	1827	Tension Wheel.....
11420	—	Tension (wheel) complete, Nos. 411D, 1560c, 8905, 11044, 11422, 11423 and two 8879.....
11950	1829	Thread Eyelet.....
2102	1827	" Retaining Disc.....
1560c	1854	" " Regulating Thumb Nut
8905	1827	" " " " " "
		Washer.....
606D	1855	Thread Retaining Screw Stud.....
2103	1827	" " Spring.....
11503	—	Thread Retainer complete, Nos. 606D, 1560c, 2103, 8905 and two 2102.....
12050	1808	Thread Take-up Cam with two 434c....
8873	1828	" " " Pin.....
434c	1852	" " " Set Screw.....
11845	1807	" " Lever with 1995.....
567D	1851	" " " Hinge Screw.....
1995	1889	" " " Roller and Screw Stud with 1518E.....
1518E	1813	Thread Take-up Lever Roller and Screw Stud Nut.....
11052	1827	Thread Take-up Spring.....
11431	1827	" " " Regulator Plate
190D	1824	" " " " " "
		Adjusting Screw.....
14634	—	Throat Plate Body.....
14514	1879	" " Needle Hole Strip, round needle hole.....
401D	1851	Throat Plate Needle Hole Strip Screw...
14515	1879	Throat Plate complete for 14512, Nos. 14514, 14634 and two 401D.....
14634	—	Throat Plate Body.....
12047	1836	" " Needle Hole Strip, oblong needle hole.....
401D	1851	Throat Plate Needle Hole Strip Screw...
14635	1839	Throat Plate complete for 14512, Nos. 12047, 14634 and two 401D.....
190D	1824	Throat Plate Screw.....
14592	1809	Vibrating Presser Bar.....
14593	1809	" " " Guide Bracket with 448c.....
14594	—	Vibrating Presser Bar Guide Bracket complete, Nos. 231c, 11472, 14593, 14595 and two 190D.....
14595	1809	Vibrating Presser Bar Guide Bracket Cap.....

NO.	PLATE	NAME
190D	1824	Vibrating Presser Bar Guide Bracket Cap Screw.....
2117	1828	Vibrating Presser Bar Guide Bracket Pin.....
448c	1852	Vibrating Presser Bar Guide Bracket Set Screw.....
14596	1828	Vibrating Presser Bar Hinge Pin.....
460c	1852	" " " " " Set Screw
11471	1829	" " " Spring.....
11472	1829	" " " " B r a c k e t
231c	1852	" " " " " "
		Screw.....
14597	1843	Vibrating Presser Foot.....
898D	1852	" " " Screw.....
1547D	1854	" " " " Nut.....

SINGER Needles should be used  
in SINGER Machines.  
These Needles and their Containers  
are marked with the  
Company's Trade Mark "SIMANCO.\*\*" 1

Needles in Containers marked  
"FOR SINGER MACHINES"  
are NOT **SINGER** made needles. 2

**MACHINE NO. 11-5**

FOR CLOTH. DROP FEED UP THE ARM

OBSOLETE

This Machine is the same as No. 11-2 with the following exceptions:

NO.	PLATE	NAME
12051	1833	Feed Dog, in place of 12027.....
12052	1833	Presser Foot, in place of 12030 and 14567.
12053	—	Throat Plate Body, in place of 12033....
12055	1833	“ “ Needle Hole Plate, in place of 12012.....
12054	1833	Throat Plate complete for 12051, Nos. 237D, 12053 and 12055, in place of 12034.....

**MACHINE NO. 11-6**FOR CLOTH. DROP FEED ACROSS THE ARM. HAS ALTERNATING  
PRESSERS AND FOOT LIFTER

OBSOLETE

This Machine is the same as No. 11-3 with the following exceptions:

NO.	PLATE	NAME
12039	1841	Feed Dog (double) in place of 14512.....
12045	—	Throat Plate Body, in place of 14634....
12046	1836	Throat Plate complete for 12039, Nos. 12045, 12047 and two 401D, in place of 14635.....
14513	—	Throat Plate complete for 12039, Nos. 12045, 14514 and two 401D, in place of 14515.....
12099	1836	Vibrating Presser Foot, in place of 11513.

**LIST OF PARTS COMPLETE**

FOR

**MACHINE NO. 11-7**FOR CLOTH OR LEATHER. DROP FEED UP THE ARM;  
½ IN. STITCH OR LESS

OBSOLETE

NO.	PLATE	NAME
*11951	—	Arm with 65D and 14710.....
8702	1828	“ Dowel Pin.....
338E	1853	“ Screw.....
11953	1800	“ Shaft.....
11954	1809	“ “ Bushing.....
446c	1852	“ “ “ Set Screw.....
6804	1804	“ “ Gear with 453c.....
2117	1828	“ “ “ Pin.....
453c	1824	“ “ “ Set Screw.....
144D	1852	“ “ Screw.....
14710	1862	“ Side Cover.....
65D	1851	“ “ Hinge Screw.....
11957	1801	“ “ Wheel with two 446c.....
446c	1852	“ “ “ Set Screw.....
6805	1804	“ “ “ Shaft.....
6806	1804	“ “ “ Gear with 453c....
2117	1828	“ “ “ “ Pin.....
453c	1824	“ “ “ “ Set Screw....
144D	1852	“ “ “ “ Screw.....
8708	1828	“ Spool Pin.....
11241	1863	“ “ “ Washer (cloth)...per 100
11960	1801	Balance Wheel with two 354c.....
354c	1101	“ “ Set Screw.....
12057	1802	Crank Connecting Rod with 12058 and two 158E.....
*12058	—	Crank Connecting Rod Cap.....
158E	1852	“ “ “ “ Screw.....
372c	1851	“ “ “ Hinge Screw.....
1518E	1813	“ “ “ “ Nut..
*12056	—	Cylinder, 3½ in. diam.....
11965	1812	Feed Bell Crank Slide.....
3032	1803	“ Cam with 446c.....
446c	1852	“ “ Set Screw.....
3033	1813	“ Connecting Link.....
375c	1813	“ “ “ Hinge Screw.....



NO.	PLATE	NAME
1518E	1813	Feed Connecting Link Hinge Screw Nut.
12059	1835	" Dog.....
190D	1824	" " Screw.....
12061	1812	" " Slide.....
12062	1802	" Forked Connection.....
375c	1813	" " " Hinge Screw....
1518E	1813	" " " " " Nut
6132	1813	" " " Universal Joint
212c	1813	" " " " " "
		Cap Screw.....
23c	1851	Feed Forked Connection Universal Joint Hinge Screw.....
11970	1813	Feed Regulator.....
58E	1813	" " Hinge Screw.....
283D	1813	" " Thumb Screw.....
12063	1803	" Rock Shaft.....
6167	1803	" " " Arm with 453c.....
2117	1828	" " " Pin.....
453c	1824	" " " " Set Screw.....
304c	1852	" " " Screw Centre.....
1513E	1824	" " " " Nut.....
12064	1801	" Rod.....
23c	1851	" " Hinge Screw.....
14507	1825	" " Raising Block.....
792c	1813	" " " Screw.....
12060	1825	" " Spring.....
207D	1852	" " " Screw.....
11975	1805	Needle Bar.....
11976	1814	" " Connecting Link.....
375c	1813	" " " " Hinge Screw
1518E	1813	" " " " " " "
		Nut.....
14547	1814	Needle Bar Connecting Stud with two 453c.....
453c	1824	Needle Bar Connecting Stud Set Screw..
258E	1854	" " Screw Bushing.....
19702	1829	" Clamp with 680D and 11385.....
11385	1825	" " Gib.....
680D	1855	" " Thumb Screw.....
11387	1857	Oil Cup.....
11917	1857	" " Cover.....
9084	1828	" " " Hinge Pin.....
2205	1825	" " " Latch Spring.....
207F	1852	" " " " Screw.....
11919	1829	" " Thread Eyelet.....
8953	1826	" or Wax Stripper (felt).....

NO.	PLATE	NAME
8482	1826	Oil or Wax Stripper Washer (steel) for 11387.....
11918	1825	Oil or Wax Stripper Washer (steel) for 11917.....
207F	1852	Oil or Wax Stripper Washer Screw.....
11920	1857	Oil Cup complete, Nos. 2205, 8482, 9084, 11387, 11917 to 11919, two 8953 and three 207F.....
135D	1852	Oil Cup Screw.....
11983	1804	Oscillating Rock Shaft with 197E, 2170, 11984, 14657 and two 11985.....
2170	1826	Oscillating Rock Shaft Oil Pad.....
197E	1852	" " " " " Screw....
304c	1852	" " " Screw Centre.....
1513E	1824	" " " " " Nut.
11984	1815	" " " Steel Plate (left)..
14657	1815	" " " " " (right)
11985	1828	" " " " " Rivet.
14639	1800	" Shaft.....
11981	1824	" " Crank with 453c and 1807.....
2117	1828	Oscillating Shaft Crank Pin.....
1807	1824	" " " Roller and Stud..
453c	1824	" " " Set Screw.....
11986	1805	Presser Bar.....
11988	1809	" " Guide Bracket with 175D and 446c.....
175D	1852	Presser Bar Guide Bracket Adjusting Screw.....
12066	1807	Presser Bar Guide Bracket Guide with 7393.....
164D	1852	Presser Bar Guide Bracket Guide Screw..
446c	1852	" " " " Set Screw....
11990	1806	" " Lifter.....
685D	1851	" " " Hinge Screw.....
7393	1828	" " " Stop Pin.....
258E	1854	" " Screw Bushing.....
11991	1805	" " Spring.....
12068	1835	" Foot.....
176D	1852	" " Screw.....
252E	1854	Pressure Regulating Thumb Screw.....
14535	1821	Shuttle Bobbin.....
12019	1819	" Cylinder.....
12000	1819	" " Hinge Pin.....
12020	1819	" " Latch Spring.....
223D	1819	" " " " Screw....
12021	1819	" Frame.....

NO.	PLATE	NAME
774c	1821	Shuttle Tension Regulating Screw.....
12022	1819	" " Spring.....
12018	1819	Shuttle (cylinder) 2½ in. diam., complete, Nos. 223D, 774c, 12000, 12019 to 12022 and 14535.....
14642	1820	Shuttle Driver and Feed Lifting Cam....
2117	1828	" " " " " " Pin.
12069	1817	" Race Ring.....
391c	1851	" " " Screw.....
12008	1814	Tension Bracket.....
190D	1824	" " Screw.....
8879	1827	" Friction Washer (cloth).....
11423	1826	" " " (steel).....
1560c	1854	" Regulating Thumb Nut.....
8905	1827	" " " " Washer..
411D	1855	" Screw Stud.....
11422	1827	" Spring.....
11044	1827	" Wheel.....
11420	—	Tension (wheel) complete, Nos. 411D, 1560c, 8905, 11044, 11422, 11423 and two 8879.....
11424	1829	Thread Eyelet (front of arm).....
11950	1829	" " (side of arm) for 11041....
2102	1827	" Retaining Disc.....
1560c	1854	" " Regulating Thumb Nut
8905	1827	" " " " " "
		Washer.....
686D	1855	Thread Retaining Screw Stud.....
2103	1827	" " Spring.....
11041	—	Thread Retainer complete, Nos. 686D, 1560c, 2103, 8905 and two 2102.....
12014	1808	Thread Take-up Cam with two 435c....
3012	1828	" " " Pin.....
435c	1852	" " " Set Screw.....
12016	1807	" " Lever with 1995.....
567D	1851	" " " Hinge Screw.....
1995	1889	" " " Roller and Screw Stud with 1518E.....
1518E	1813	Thread Take-up Lever Roller and Screw Stud Nut.....
11052	1827	Thread Take-up Spring.....
11431	1827	" " " Regulator Plate
190D	1824	" " " " " "
		Adjusting Screw.....
12070	1835	Throat Plate for 12059.....
190D	1824	" " Screw.....

**LIST OF PARTS COMPLETE  
FOR  
MACHINE NO. 11-8**

**FOR CLOTH. HAS REVERSIBLE DROP FEED. UP OR OFF ARM, STITCH  
FROM ¼ TO ½ INCH LONG, S. D. A.**

NO.	PLATE	NAME
*14643	—	Arm with 65D, 145D, 159D, 6169 and 14710.
8702	1828	" Dowel Pin.....
338E	1853	" Screw.....
14539	1800	" Shaft.....
11954	1809	" " Bushing.....
446c	1852	" " " Set Screw.....
6804	1804	" " Gear with 453c.....
2117	1828	" " " Pin.....
453c	1824	" " " Set Screw.....
144D	1852	" " Screw.....
14710	1862	" Side Cover.....
65D	1851	" " " Hinge Screw.....
11957	1801	" " Wheel with two 446c.....
446c	1852	" " " Set Screw.....
6805	1804	" " " Shaft.....
6806	1804	" " " " Gear with 453c...
2117	1828	" " " " " Pin.....
453c	1824	" " " " " Set Screw....
144D	1852	" " " " " Screw.....
8708	1828	" Spool Pin.....
11241	1863	" " " Washer (cloth)...per 100
14644	1858	Balance Wheel with two 354c.....
354c	1101	" " Set Screw.....
56509	1864	Cloth Plate.....
14737	1865	" " Bracket with two 345c.....
345c	1889	" " " Set Screw.....
56511	—	Cloth Plate with Bracket complete, Nos. 14737, 56509 and two 389F.....
389F	1851	Cloth Plate Screw.....
14540	1802	Crank Connecting Rod with 14541 and two 145E.....
*14541	—	Crank Connecting Rod Cap.....
145E	1852	" " " " Screw.....
565c	1851	" " " Hinge Screw.....
1513E	1824	" " " " Nut..
*14637	—	Cylinder, 3½ in. diam.....
3032	1803	Feed Cam with 446c.....

NO.	PLATE	NAME
446c	1852	Feed Cam Set Screw.....
3033	1813	" Connecting Link.....
375c	1813	" " " Hinge Screw.....
1513E	1813	" " " " " Nut..
14645	1848	" Dog.....
176D	1852	" " Screw.....
14646	1802	" Forked Connection.....
375c	1813	" " " Hinge Screw....
1513E	1813	" " " " " Nut.
6132	1813	" " " Universal Joint
212c	1813	" " " " " "
		Cap Screw.....
23c	1851	Feed Forked Connection Universal Joint Hinge Screw.....
14647	1815	Feed Regulator Crank with two 448c....
448c	1852	" " " Set Screw.....
6808	1815	" " " Lever with 460c.....
6809	—	Feed Regulator Lever complete, Nos. 190D, 6808 and 6810.....
732D	1855	Feed Regulator Lever Adjusting Thumb Screw.....
1584E	1854	Feed Regulator Lever Adjusting Thumb Screw Nut.....
3146	1826	Feed Regulator Lever Adjusting Thumb Screw Washer.....
6810	1815	Feed Regulator Lever Friction Plate
190D	1824	" " " " " " Screw.....
2049	1828	Feed Regulator Lever Pin.....
460c	1852	" " " Set Screw.....
732D	1855	" " " Thumb Screw
3146	1826	" " " " " " Washer.....
14648	1807	Feed Regulator Segment.....
190D	1824	" " " Screw.....
14649	1800	" " Shaft.....
6169	1866	" " " Bracket.....
145D	1852	" " " " " Screw (lower).....
159D	1852	Feed Regulator Shaft Bracket Screw (upper).....
14565	1803	Feed Rock Shaft.....
14505	1803	" " " Arm with 436c.....
2117	1828	" " " " Pin.....
436c	1852	" " " " Set Screw.....
304c	1852	" " " Screw Centre.....
1513E	1824	" " " " " Nut.....

NO.	PLATE	NAME
14638	1801	Feed Rod.....
23c	1851	" " Hinge Screw.....
14507	1825	" " Raising Block.....
792c	1813	" " " " Screw.....
14501	1825	" " Spring.....
219D	1889	" " " Screw.....
11975	1805	Needle Bar.....
11976	1814	" " Connecting Link.....
375c	1813	" " " " Hinge Screw
1513E	1813	" " " " " " Nut.....
14547	1814	Needle Bar Connecting Stud with two 453c.....
453c	1824	Needle Bar Connecting Stud Set Screw..
258E	1854	" " Screw Bushing.....
19702	1829	" Clamp with 680D and 11385.....
11385	1825	" " Gib.....
680D	1855	" " Thumb Screw.....
11497	1857	Oil Cup.....
11917	1857	" " Cover.....
9084	1828	" " Hinge Pin.....
2205	1825	" " " Latch Spring.....
207F	1852	" " " " " Screw.....
11919	1829	" " Thread Eyelet.....
8953	1826	" or Wax Stripper (felt).....
8482	1826	" " " " Washer (steel) for 11497.....
11918	1825	Oil or Wax Stripper Washer (steel) for 11917.....
207F	1852	Oil or Wax Stripper Washer Screw.....
11921	1857	Oil Cup complete, Nos. 2205, 8482, 9084, 11497, 11917 to 11919, two 8953 and three 207F.....
134D	1852	Oil Cup Screw.....
12090	1804	Oscillating Rock Shaft with 11165.....
11164	1804	" " " Hinge Pin.....
435c	1852	" " " " " " S e t Screw.....
11165	1826	Oscillating Rock Shaft Oil Pad.....
14639	1800	" Shaft.....
13324	—	" " Crank.....
13416	1824	Oscillating Shaft Crank complete, Nos. 453c, 1513E, 5868 and 13324.....
2117	1828	Oscillating Shaft Crank Pin.....
453c	1824	" " " Set Screw.....
9119	1824	" " " Slide Block.....

NO.	PLATE	NAME
5868	1824	Oscillating Shaft Crank Slide Block complete, Nos. 190D, 1054C, 5968 and 9119.
190D	1824	Oscillating Shaft Crank Slide Block Cap Screw.....
5968	1824	Oscillating Shaft Crank Slide Block Cap Screw Washer.....
1054C	1824	Oscillating Shaft Crank Slide Block Screw Stud.....
1513E	1824	Oscillating Shaft Crank Slide Block Screw Stud Nut.....
11986	1805	Presser Bar.....
11988	1809	" " Guide Bracket with 175D and 446C.....
175D	1852	Presser Bar Guide Bracket Adjusting Screw.....
12066	1807	Presser Bar Guide Bracket Guide with 7393.....
164D	1852	Presser Bar Guide Bracket Guide Screw..
446C	1852	" " " " Set Screw....
11990	1806	" " Lifter.....
685D	1851	" " Hinge Screw.....
7393	1828	" " Stop Pin.....
258E	1854	" " Screw Bushing.....
11991	1805	" " Spring.....
14650	1848	" Foot.....
176D	1852	" " Screw.....
252E	1854	Pressure Regulating Thumb Screw.....
14535	1821	Shuttle Bobbin.....
11999	1821	" Cylinder.....
12000	1819	" " Hinge Pin.....
12001	1821	" " Latch.....
2027	1821	" " Pin.....
11854	1821	" " Spring.....
590E	1821	" " " " Screw....
12004	1821	" Frame.....
774C	1821	" Tension Regulating Screw.....
12005	1821	" Spring.....
11997	1821	Shuttle (cylinder) 2½ in. diam., complete, Nos. 590E, 774C, 2027, 11854, 11999 to 12001, 12004, 12005 and 14535.....
14640	1823	Shuttle Driver and Feed Lifting Cam....
2117	1828	" " " " " " Pin.....
14554	1818	" Race.....
141C	1852	" " Screw.....
12008	1814	Tension Bracket.....
190D	1824	" " Screw.....
8879	1827	" Friction Washer (cloth).....

NO.	PLATE	NAME
11423	1826	Tension Friction Washer (steel).....
1560C	1854	" Regulating Thumb Nut.....
8905	1827	" " " " Washer..
411D	1855	" Screw Stud.....
11422	1827	" Spring.....
11044	1827	" Wheel.....
11420	—	Tension (wheel) complete, Nos. 411D, 1560C, 8905, 11044, 11422, 11423 and two 8879.....
14555	1829	Thread Eyelet (front of arm).....
11950	1829	" " (side of arm) for 11041....
2102	1827	" Retaining Disc.....
1560C	1854	" " Regulating Thumb Nut
8905	1827	" " " " " "
		Washer.....
686D	1855	Thread Retaining Screw Stud.....
2103	1827	" " Spring.....
11041	—	Thread Retainer complete, Nos. 686D, 1560C, 2103, 8905 and two 2102.....
12014	1808	Thread Take-up Cam with two 435C....
3012	1828	" " " Pin.....
435C	1852	" " " Set Screw.....
12016	1807	" " Lever with 1995.....
567D	1851	" " Hinge Screw.....
1995	1889	" " " Roller and Screw Stud with 1518E.....
1518E	1813	Thread Take-up Lever Roller and Screw Stud Nut.....
11052	1827	Thread Take-up Spring.....
11431	1827	" " " Regulator Plate
190D	1824	" " " " " "
		Adjusting Screw.....
14641	1848	Throat Plate for 14645.....
14519	1837	" " Holder.....
389F	1851	" " " Screw.....
202D	1852	" " Screw (long).....
228D	1852	" " " (short).....

For Driving Attachment Parts, see Page 101

NO.	PLATE	NAME
5868	1824	Oscillating Shaft Crank Slide Block complete, Nos. 190D, 1054c, 5968 and 9119.
190D	1824	Oscillating Shaft Crank Slide Block Cap Screw.....
5968	1824	Oscillating Shaft Crank Slide Block Cap Screw Washer.....
1054c	1824	Oscillating Shaft Crank Slide Block Screw Stud.....
1513E	1824	Oscillating Shaft Crank Slide Block Screw Stud Nut.....
11986	1805	Presser Bar.....
11988	1809	" " Guide Bracket with 175D and 446c.....
175D	1852	Presser Bar Guide Bracket Adjusting Screw.....
12066	1807	Presser Bar Guide Bracket Guide with 7393.....
164D	1852	Presser Bar Guide Bracket Guide Screw..
446c	1852	" " " " Set Screw....
11990	1806	" " Lifter.....
685D	1851	" " Hinge Screw.....
7393	1828	" " Stop Pin.....
258E	1854	" " Screw Bushing.....
11991	1805	" " Spring.....
14650	1848	" Foot.....
176D	1852	" " Screw.....
252E	1854	Pressure Regulating Thumb Screw.....
14535	1821	Shuttle Bobbin.....
11999	1821	" Cylinder.....
12000	1819	" " Hinge Pin.....
12001	1821	" " Latch.....
2027	1821	" " Pin.....
11854	1821	" " Spring.....
590E	1821	" " " " Screw.....
12004	1821	" Frame.....
774c	1821	" Tension Regulating Screw.....
12005	1821	" Spring.....
11997	1821	Shuttle (cylinder) 2½ in. diam., complete, Nos. 590E, 774c, 2027, 11854, 11999 to 12001, 12004, 12005 and 14535.....
14640	1823	Shuttle Driver and Feed Lifting Cam....
2117	1828	" " " " " " Pin.....
14554	1818	" Race.....
141c	1852	" " Screw.....
12008	1814	Tension Bracket.....
190D	1824	" " Screw.....
8879	1827	" Friction Washer (cloth).....

NO.	PLATE	NAME
11423	1826	Tension Friction Washer (steel).....
1560c	1854	" Regulating Thumb Nut.....
8905	1827	" " " " Washer..
411D	1855	" Screw Stud.....
11422	1827	" Spring.....
11044	1827	" Wheel.....
11420	—	Tension (wheel) complete, Nos. 411D, 1560c, 8905, 11044, 11422, 11423 and two 8879.....
14555	1829	Thread Eyelet (front of arm).....
11950	1829	" " (side of arm) for 11041....
2102	1827	" Retaining Disc.....
1560c	1854	" " Regulating Thumb Nut
8905	1827	" " " " " "
		Washer.....
686D	1855	Thread Retaining Screw Stud.....
2103	1827	" " Spring.....
11041	—	Thread Retainer complete, Nos. 686D, 1560c, 2103, 8905 and two 2102.....
12014	1808	Thread Take-up Cam with two 435c....
3012	1828	" " Pin.....
435c	1852	" " Set Screw.....
12016	1807	" " Lever with 1995.....
567D	1851	" " Hinge Screw.....
1995	1889	" " Roller and Screw
		Stud with 1518E.....
1518E	1813	Thread Take-up Lever Roller and Screw
		Stud Nut.....
11052	1827	Thread Take-up Spring.....
11431	1827	" " " Regulator Plate
190D	1824	" " " " " "
		Adjusting Screw.....
14641	1848	Throat Plate for 14645.....
14519	1837	" " Holder.....
389F	1851	" " Screw.....
202D	1852	" " Screw (long).....
228D	1852	" " (short).....

For Driving Attachment Parts, see Page 101

## MACHINE NO. 11-9

FOR CLOTH. DROP FEED ACROSS THE ARM

OBSOLETE

This Machine is the same as No. 11-2 with the following exceptions:

NO.	PLATE	NAME
12072	1838	Feed Dog (left of needle) in place of 12027
12071	1832	" " (right of needle).....
	792c 1813	" " Screw.....
12074	1831	Presser Foot (left of needle) in place of 12030 and 14567.....
12073	1832	Presser Foot (right of needle).....
12075	—	Throat Plate Body for 12077, in place of 12033.....
12079	1832	Throat Plate Needle Hole Plate for 12077, in place of 12012.....
12077	1832	Throat Plate complete for 12071, Nos. 237d, 12075 and 12079.....
12076	—	Throat Plate Body for 12078.....
12080	1880	" " Needle Hole Strip, round needle hole, for 12078.....
	401d 1851	Throat Plate Needle Hole Strip Screw...
12078	1880	Throat Plate complete for 12072, Nos. 12076, 12080 and two 401d.....
12076	—	Throat Plate Body for 14517.....
14518	1831	" " Needle Hole Strip, oblong needle hole, for 14517.....
	401d 1851	Throat Plate Needle Hole Strip Screw...
14517	1831	Throat Plate complete for 12072, Nos. 12076, 14518 and two 401d.....

## LIST OF PARTS COMPLETE

FOR

## MACHINE NO. 11-11

FOR LEATHER. DROP FEED ACROSS THE ARM

NO.	PLATE	NAME
*11951	—	Arm with 65d and 14710.....
8702	1828	" Dowel Pin.....
338E	1853	" Screw.....
14539	1800	" Shaft.....
11954	1809	" " Bushing.....
446c	1852	" " " Set Screw.....
6804	1804	" " Gear with 453c.....
2117	1828	" " " Pin.....
453c	1824	" " " Set Screw.....
144d	1852	" " Screw.....
14710	1862	" Side Cover.....
65d	1851	" " " Hinge Screw.....
11957	1801	" " Wheel with two 446c.....
446c	1852	" " " Set Screw.....
6805	1804	" " " Shaft.....
6806	1804	" " " Gear with 453c...
2117	1828	" " " " " Pin.....
453c	1824	" " " " " Set Screw....
144d	1852	" " " " " Screw.....
8708	1828	" Spool Pin.....
11241	1863	" " " Washer (cloth)....per 100
11960	1801	Balance Wheel with two 354c.....
354c	1101	" " " Set Screw.....
14540	1802	Crank Connecting Rod with 14541 and two 145E.....
*14541	—	Crank Connecting Rod Cap.....
145E	1852	" " " " Screw.....
565c	1851	" " " " Hinge Screw.....
1513E	1824	" " " " " Nut..
*14542	—	Cylinder, 3½ in. diam.....
3032	1803	Feed Cam with 446c.....
446c	1852	" " Set Screw.....
3033	1813	" Connecting Link.....
375c	1813	" " " Hinge Screw.....
1518E	1813	" " " " " Nut..
14724	1881	" Dog (left of needle).....
14723	1881	" " (right of needle).....
14715	1866	" " Carrier.....

NO.	PLATE	NAME
792c	1813	Feed Dog Screw.....
12062	1802	" Forked Connection.....
375c	1813	" " " Hinge Screw....
1518E	1813	" " " " " Nut.....
6132	1813	" " " " " Universal Joint
212c	1813	" " " " " " "
		Cap Screw.....
23c	1851	Feed Forked Connection Universal Joint
		Hinge Screw.....
11970	1813	Feed Regulator.....
58E	1813	" " " Hinge Screw.....
818D	1889	" " " Thumb Screw.....
14545	1801	" Rock Shaft.....
14546	1803	" " " for 304c.....
14505	1803	" " " Arm with 436c.....
2117	1828	" " " " Pin.....
436c	1852	" " " " Set Screw.....
4448	1828	" " " Back Bearing Oil Tube.
14526	1803	" " " Crank (forked) with
		445c for 14545.....
14522	1803	Feed Rock Shaft Crank with 445c, for
		14524.....
14524	—	Feed Rock Shaft Crank complete for
		14546, Nos. 164D, 6312, 14522 and
		14523.....
3012	1828	Feed Rock Shaft Crank Pin for 14526....
2117	1828	" " " " " " 14522...
14523	1825	" " " " " Roller.....
164D	1852	" " " " " Cap Screw
6312	1826	" " " " " " "
		Washer.....
445c	1852	Feed Rock Shaft Crank Set Screw.....
304c	1852	" " " Screw Centre.....
1513E	1824	" " " " " Nut.....
11975	1805	Needle Bar.....
11976	1814	" " Connecting Link.....
375c	1813	" " " " " Hinge Screw
1518E	1813	" " " " " " "
		Nut.....
14547	1814	Needle Bar Connecting Stud with two
		453c.....
453c	1824	Needle Bar Connecting Stud Set Screw..
258E	1854	" " Screw Bushing.....
19702	1829	" Clamp with 680D and 11385.....
11385	1825	" " Gib.....
680D	1855	" " Thumb Screw.....
11497	1857	Oil Cup.....

NO.	PLATE	NAME
11917	1857	Oil Cup Cover.....
9084	1828	" " " Hinge Pin.....
2205	1825	" " " Latch Spring.....
207F	1852	" " " " " Screw.....
11919	1829	" " Thread Eyelet.....
8953	1826	" or Wax Stripper (felt).....
8482	1826	" " " " Washer (steel) for
		11497.....
11918	1825	Oil or Wax Stripper Washer (steel) for
		11917.....
207F	1852	Oil or Wax Stripper Washer Screw.....
11921	1857	Oil Cup complete, Nos. 2205, 8482, 9084,
		11497, 11917 to 11919, two 8953 and
		three 207F.....
134D	1852	Oil Cup Screw.....
12090	1804	Oscillating Rock Shaft with 11165.....
11164	1804	" " " Hinge Pin.....
435c	1852	" " " " " S e t
		Screw.....
11165	1826	Oscillating Rock Shaft Oil Pad.....
14548	1800	" Shaft.....
13324	—	" " Crank.....
13416	1824	Oscillating Shaft Crank complete, Nos.
		453c, 1513E, 5868 and 13324.....
2117	1828	Oscillating Shaft Crank Pin.....
453c	1824	" " " Set Screw.....
9119	1824	" " " Slide Block.....
5868	1824	Oscillating Shaft Crank Slide Block com-
		plete, Nos. 190D, 1054c, 5968 and 9119.
190D	1824	Oscillating Shaft Crank Slide Block Cap
		Screw.....
5968	1824	Oscillating Shaft Crank Slide Block Cap
		Screw Washer.....
1054c	1824	Oscillating Shaft Crank Slide Block Screw
		Stud.....
1513E	1824	Oscillating Shaft Crank Slide Block Screw
		Stud Nut.....
11986	1805	Presser Bar.....
11988	1809	" " Guide Bracket with 175D and
		446c.....
175D	1852	Presser Bar Guide Bracket Adjusting
		Screw.....
12066	1807	Presser Bar Guide Bracket Guide with
		7393.....
164D	1852	Presser Bar Guide Bracket Guide Screw..
446c	1852	" " " " Set Screw....
11990	1806	" " Lifter.....

NO.	PLATE	NAME
685D	1851	Presser Bar Lifter Hinge Screw
7393	1828	" " " Stop Pin
258E	1854	" " Screw Bushing
11991	1805	" " Spring
14550	1842	" Foot (left of needle)
14549	1840	" " (right of needle)
176D	1852	" " Screw
252E	1854	Pressure Regulating Thumb Screw
1899	1840	Roller, 1¼ in., with 634D and 1528D
11994	1840	" Arm for 11992
14551	1842	" " " 14553
440F	1852	" " Adjusting Screw
1547D	1854	" " " Nut
11995	1840	" " Bracket for 11992
14552	1842	" " " " 14553
316F	1852	" " " Screw Centre
1547D	1854	" " " " Nut
2205	1825	" " Lock Spring
207F	1852	" " " " Screw
634D	1840	" Screw
1528D	1854	" Nut
14553	1842	Roller Presser (left of needle) 1¼ in. roller, complete, Nos. 207F, 440F, 1899, 2205, 14551, 14552, two 316F and three 1547D
11992	1840	Roller Presser (right of needle) 1¼ in. roller, complete, Nos. 207F, 440F, 1899, 2205, 11994, 11995, two 316F and three 1547D
176D	1852	Roller Presser Screw
14535	1821	Shuttle Bobbin
12093	1820	" Cylinder
12000	1819	" " Hinge Pin
12001	1821	" " Latch
2027	1821	" " " Pin
11854	1821	" " " Spring
590E	1821	" " " Screw
12094	1820	" Frame
773C	1820	" Tension Regulating Screw
12095	1820	" " Spring
12092	1820	Shuttle (cylinder) 2½ in. diam., complete, Nos. 590E, 773C, 2027, 11854, 12000, 12001, 12093 to 12095 and 14535
12006	1821	Shuttle Driver and Feed Lifting Cam
2049	1828	" " " " " " Pin
14554	1818	" Race
141C	1852	" " Screw
12008	1814	Tension Bracket

NO.	PLATE	NAME
190D	1824	Tension Bracket Screw
8879	1827	" Friction Washer (cloth)
11423	1826	" " " (steel)
1560C	1854	" Regulating Thumb Nut
8905	1827	" " " Washer
411D	1855	" Screw Stud
11422	1827	" Spring
11044	1827	" Wheel
11420	—	Tension (wheel) complete, Nos. 411D, 1560C, 8905, 11044, 11422, 11423 and two 8879
14555	1829	Thread Eyelet (front of arm)
11950	1829	" " (side of arm) for 11041
2102	1827	" Retaining Disc
1560C	1854	" " Regulating Thumb Nut
8905	1827	" " " " " "
686D	1855	Washer
2103	1827	Thread Retaining Screw Stud
11041	—	" " Spring
12014	1808	Thread Retainer complete, Nos. 686D, 1560C, 2103, 8905 and two 2102
3012	1828	Thread Take-up Cam with two 435C
435C	1852	" " " Pin
12016	1807	" " " Set Screw
567D	1851	" " Lever with 1995
1995	1889	" " " Hinge Screw
1518E	1813	" " " Roller and Screw Stud with 1518E
11052	1827	Thread Take-up Lever Roller and Screw Stud Nut
11431	1827	Thread Take-up Spring
190D	1824	" " " Regulator Plate
14556	1840	" " " " " " Adjusting Screw
14557	1842	Throat Plate for 14723
14519	1837	" " " 14724
389F	1851	" " " Holder
202D	1852	" " " Screw
228D	1852	" " " Screw (long)
		" " " (short)



## MACHINE NO. 11-12

FOR CLOTH. DROP FEED ACROSS THE ARM

This Machine is the same as No. 11-11 with the following exceptions:

NO.	PLATE	NAME
14716	1881	Feed Dog (left of needle) for 14715, in place of 14724.....
14722	1881	Feed Dog (right of needle) for 14715, in place of 14723.....
14720	1881	Feed Dog (double).....
14559	1838	Presser Foot (left of needle) for 14716, in place of 14550 and 14553.....
14558	1838	Presser Foot (right of needle) for 14722, in place of 11992 and 14549.....
14560	1841	Presser Foot for 14720.....
14520	1838	Throat Plate for 14716, in place of 14556.
14521	1838	" " for 14722, in place of 14557.
14561	—	" " Body.....
14563	1841	" " Needle Hole Strip.....
401d	1851	" " " " " Screw....
14562	1841	Throat Plate complete for 14720, Nos. 14561, 14563 and two 401d.....

## LIST OF PARTS COMPLETE FOR MACHINE NO. 11-13

FOR LEATHER. DROP FEED UP THE ARM

NO.	PLATE	NAME
*11951	—	Arm with 65d and 14710.....
8702	1828	" Dowel Pin.....
338E	1853	" Screw.....
14539	1800	" Shaft.....
11954	1809	" " Bushing.....
446c	1852	" " " Set Screw.....
6804	1804	" " Gear with 453c.....
2117	1828	" " " Pin.....
453c	1824	" " " Set Screw.....
144d	1852	" " Screw.....
14710	1862	" Side Cover.....
65d	1851	" " Hinge Screw.....
11957	1801	" " Wheel with two 446c.....
446c	1852	" " " Set Screw.....
6805	1804	" " " Shaft.....
6806	1804	" " " " " Gear with 453c...
2117	1828	" " " " " Pin.....
453c	1824	" " " " " Set Screw....
144d	1852	" " " " " Screw.....
8708	1828	" Spool Pin.....
11241	1863	" " " Washer (cloth)....per 100
11960	1801	Balance Wheel with two 354c.....
354c	1101	" " " Set Screw.....
14540	1802	Crank Connecting Rod with 14541 and two 145E.....
*14541	—	Crank Connecting Rod Cap.....
145E	1852	" " " " " Screw.....
565c	1851	" " " " " Hinge Screw.....
1513E	1824	" " " " " Nut..
*14542	—	Cylinder, 3 1/8 in. diam.....
3032	1803	Feed Cam with 446c.....
446c	1852	" " Set Screw.....
3033	1813	" Connecting Link.....
375c	1813	" " " Hinge Screw.....
1518E	1813	" " " " " Nut..
14564	1844	" Dog.....
14733	1866	" " Adjusting Piece.....
14715	1866	" " " " " Carrier.....

NO.	PLATE	NAME
792c	1813	Feed Dog Adjusting Piece Screw.....
176d	1852	" " Screw.....
12062	1802	" Forked Connection.....
375c	1813	" " " Hinge Screw.....
1518e	1813	" " " " " Nut.....
6132	1813	" " " Universal Joint.....
212c	1813	" " " " " ".....
		Cap Screw.....
23c	1851	Feed Forked Connection Universal Joint Hinge Screw.....
11970	1813	Feed Regulator.....
58e	1813	" " Hinge Screw.....
818d	1889	" " Thumb Screw.....
14545	1801	" Rock Shaft.....
14565	1803	" " " for 304c.....
14505	1803	" " " Arm with 436c.....
2117	1828	" " " Pin.....
436c	1852	" " " Set Screw.....
4448	1828	" " " Back Bearing Oil Tube.....
14526	1803	" " " Crank (forked) with 445c, for 14545.....
14522	1803	Feed Rock Shaft Crank with 445c, for 14524.....
14524	—	Feed Rock Shaft Crank complete for 14565, Nos. 164d, 6312, 14522 and 14523.....
3012	1828	Feed Rock Shaft Crank Pin for 14526....
2117	1828	" " " " " 14522....
14523	1825	" " " " Roller.....
164d	1852	" " " " " Cap Screw.....
6312	1826	" " " " " " ".....
		Washer.....
445c	1852	Feed Rock Shaft Crank Set Screw.....
304c	1852	" " " Screw Centre.....
1513e	1824	" " " " " Nut.....
14566	1801	" Rod.....
23c	1851	" " Hinge Screw.....
14501	1825	" " Spring.....
219d	1889	" " " Screw.....
11975	1805	Needle Bar.....
11976	1814	" " Connecting Link.....
375c	1813	" " " " Hinge Screw.....
1518e	1813	" " " " " ".....
		Nut.....
14547	1814	Needle Bar Connecting Stud with two 453c.....
453c	1824	Needle Bar Connecting Stud Set Screw..

NO.	PLATE	NAME
258e	1854	Needle Bar Screw Bushing.....
19702	1829	" Clamp with 680d and 11385.....
11385	1825	" " Gib.....
680d	1855	" " Thumb Screw.....
11497	1857	Oil Cup.....
11917	1857	" " Cover.....
9084	1828	" " " Hinge Pin.....
2205	1825	" " " Latch Spring.....
207f	1852	" " " " Screw.....
11919	1829	" " Thread Eyelet.....
8953	1826	" or Wax Stripper (felt).....
8482	1826	" " " Washer (steel) for 11497.....
11918	1825	Oil or Wax Stripper Washer (steel) for 11917.....
207f	1852	Oil or Wax Stripper Washer Screw.....
11921	1857	Oil Cup complete, Nos. 2205, 8482, 9084, 11497, 11917 to 11919, two 8953 and three 207f.....
134d	1852	Oil Cup Screw.....
12090	1804	Oscillating Rock Shaft with 11165.....
11164	1804	" " " Hinge Pin.....
435c	1852	" " " " " S e t Screw.....
11165	1826	Oscillating Rock Shaft Oil Pad.....
14548	1800	" Shaft.....
13324	—	" " Crank.....
13416	1824	Oscillating Shaft Crank complete, Nos. 453c, 1513e, 5868 and 13324.....
2117	1828	Oscillating Shaft Crank Pin.....
453c	1824	" " " Set Screw.....
9119	1824	" " " Slide Block.....
5868	1824	Oscillating Shaft Crank Slide Block complete, Nos. 190d, 1054c, 5968 and 9119.....
190d	1824	Oscillating Shaft Crank Slide Block Cap Screw.....
5968	1824	Oscillating Shaft Crank Slide Block Cap Screw Washer.....
1054c	1824	Oscillating Shaft Crank Slide Block Screw Stud.....
1513e	1824	Oscillating Shaft Crank Slide Block Screw Stud Nut.....
11986	1805	Presser Bar.....
11988	1809	" " Guide Bracket with 175d and 446c.....
175d	1852	Presser Bar Guide Bracket Adjusting Screw.....

NO.	PLATE	NAME
12066	1807	Presser Bar Guide Bracket Guide with 7393.....
164D	1852	Presser Bar Guide Bracket Guide Screw..
446C	1852	" " " " Set Screw....
11990	1806	" " Lifter.....
685D	1851	" " Hinge Screw.....
7393	1828	" " Stop Pin.....
258E	1854	" " Screw Bushing.....
11991	1805	" " Spring.....
14567	1844	" Foot (left of needle).....
176D	1852	" " Screw.....
252E	1854	Pressure Regulating Thumb Screw.....
1899	1840	Roller, 1¼ in., with 634D and 1528D....
12031	1844	" Arm.....
440F	1852	" " Adjusting Screw.....
1547D	1854	" " " " Nut.....
12032	1844	" " Bracket.....
316F	1852	" " " " Screw Centre.....
1547D	1854	" " " " " Nut....
2205	1825	" " Lock Spring.....
176D	1852	" " " " Screw.....
1549D	1854	" " " " " Nut.....
634D	1840	" Screw.....
1528D	1854	" " Nut.....
12030	1844	Roller Presser, 1¼ in. roller, complete, Nos. 176D, 440F, 1549D, 1899, 2205, 12031, 12032, two 316F and three 1547D
176D	1852	Roller Presser Screw.....
14535	1821	Shuttle Bobbin.....
11999	1821	" Cylinder.....
12000	1819	" " Hinge Pin.....
12001	1821	" " Latch.....
2027	1821	" " Pin.....
11854	1821	" " " Spring.....
590E	1821	" " " " Screw....
12004	1821	" Frame.....
774C	1821	" Tension Regulating Screw.....
12005	1821	" " Spring.....
11997	1821	Shuttle (cylinder) 2½ in. diam., complete, Nos. 590E, 774C, 2027, 11854, 11999 to 12001, 12004, 12005 and 14535.....
12006	1821	Shuttle Driver and Feed Lifting Cam....
2049	1828	" " " " " " Pin.
14554	1818	" Race.....
141C	1852	" " Screw.....
12008	1814	Tension Bracket.....
190D	1824	" " Screw.....

NO.	PLATE	NAME
8879	1827	Tension Friction Washer (cloth).....
11423	1826	" " " (steel).....
1560C	1854	" Regulating Thumb Nut.....
8905	1827	" " " " Washer..
411D	1855	" Screw Stud.....
11422	1827	" Spring.....
11044	1827	" Wheel.....
11420	—	Tension (wheel) complete, Nos. 411D, 1560C, 8905, 11044, 11422, 11423 and two 8879.....
14555	1829	Thread Eyelet (front of arm).....
11950	1829	" " (side of arm) for 11041....
2102	1827	" Retaining Disc.....
1560C	1854	" " Regulating Thumb Nut
8905	1827	" " " " " "
		Washer.....
686D	1855	Thread Retaining Screw Stud.....
2103	1827	" " Spring.....
11041	—	Thread Retainer complete, Nos. 686D, 1560C, 2103, 8905 and two 2102.....
12014	1808	Thread Take-up Cam with two 435C....
3012	1828	" " " Pin.....
435C	1852	" " " Set Screw.....
12016	1807	" " Lever with 1995.....
567D	1851	" " " Hinge Screw.....
1995	1889	" " " Roller and Screw Stud with 1518E.....
1518E	1813	Thread Take-up Lever Roller and Screw Stud Nut.....
11052	1827	Thread Take-up Spring.....
11431	1827	" " " Regulator Plate
190D	1824	" " " " " "
		Adjusting Screw.....
14568	1844	Throat Plate for 14564.....
14519	1837	" " Holder.....
389F	1851	" " " Screw.....
202D	1852	" " Screw (long).....
228D	1852	" " " (short).....

## MACHINE NO. 11-14

### FOR CLOTH. DROP FEED UP THE ARM

This Machine is the same as No. 11-13 with the following exceptions:

NO.	PLATE	NAME
14569	1845	Feed Dog (left of needle) in place of 14564
14570	1882	" " (double).....
14571	1845	Presser Foot (left of needle) for 14569, in place of 12030 and 14567.....
14680	1862	Presser Foot (short right toe) for 14570..
14572	1847	" " for 14570.....
14573	1845	Throat Plate for 14569, in place of 14568.
14574	1847	" " " 14570.....
14681	1882	" " (rounded edges) for 14570..

## LIST OF PARTS COMPLETE

### FOR

## MACHINE NO. 11-15

FOR CARRIAGE AND BUGGY DASHES; FURNISHED WITH FEED DOGS, THROAT PLATES AND PRESSER FEET FOR DIFFERENT POSITIONS OF THE WORK WHEN CLOSING IN THE FRAME AND STITCHING THE PANELS; DROP FEED ACROSS THE ARM; HAS 30 INCHES CLEAR SPACE AT RIGHT OF NEEDLE, VIBRATING PRESSER, S. D. A., AND COLUMN STAND

NO.	PLATE	NAME
*14787	—	Arm with 65D and 14578.....
8702	1828	" Dowel Pin.....
496E	1853	" Screw.....
14735	1867	" Shaft.....
11354	1809	" " Bushing.....
437C	1852	" " Set Screw.....
14606	1804	" " Gear with two 445c.....
3012	1828	" " " Pin.....
445C	1852	" " " Set Screw.....
14578	1857	" Side Cover.....
65D	1851	" " " Hinge Screw.....
14579	1801	" " Wheel with two 446c.....

NO.	PLATE	NAME
446C	1852	Arm Side Wheel Set Screw.....
14607	1804	" " " Shaft.....
14608	1804	" " " " Gear with 453c....
2117	1828	" " " " " Pin.....
453C	1824	" " " " " Set Screw....
144D	1852	" " " " " Screw.....
8708	1828	" Spool Pin.....
11241	1863	" " " Washer (cloth)....per 100
11438	1858	Balance Wheel with two 354c.....
8873	1828	" " " Pin.....
354C	1101	" " " Set Screw.....
11363	1802	Crank Connecting Rod with 11364 and two 145E.....
*11364	—	Crank Connecting Rod Cap.....
145E	1852	" " " " " Screw.....
565C	1851	" " " " " Hinge Screw.....
1513E	1824	" " " " " " Nut..
*14581	—	Cylinder, 3 $\frac{1}{8}$ in. diam.....
11367	1803	Feed Cam with two 445c.....
445C	1852	" " " Set Screw.....
11368	1803	" Connecting Link.....
565C	1851	" " " " " Hinge Screw.....
1513E	1824	" " " " " " Nut..
14726	1881	" Dog (left of needle).....
14727	1883	" " (right of needle) for panel work
14725	1881	" " for closing.....
14715	1866	" " Carrier.....
792C	1813	" " Screw.....
14502	1802	" Forked Connection.....
565C	1851	" " " " " Hinge Screw....
1513E	1824	" " " " " " Nut..
6132	1813	" " " " " Universal Joint
212C	1813	" " " " " " " Cap Screw.....
23C	1851	Feed Forked Connection Universal Joint Hinge Screw.....
14583	1803	Feed Regulator.....
568E	1851	" " " Hinge Screw.....
254D	1813	" " " Thumb Screw.....
14525	1801	" Rock Shaft.....
14504	1803	" " " for 300c.....
14505	1803	" " " Arm with 436c.....
2117	1828	" " " " " Pin.....
436C	1852	" " " " " Set Screw.....
4448	1828	" " " Back Bearing Oil Tube
14526	1803	" " " Crank (forked) with 445c, for 14525.....

NO.	PLATE	NAME
14522	1803	Feed Rock Shaft Crank with 445c, for 14524.....
14524	—	Feed Rock Shaft Crank complete for 14504, Nos. 164d, 6312, 14522 and 14523.....
3012	1828	Feed Rock Shaft Crank Pin for 14526...
2117	1828	" " " " " " 14522...
14523	1825	" " " " Roller.....
164d	1852	" " " " " Cap Screw
6312	1826	" " " " " " " Washer.....
445c	1852	Feed Rock Shaft Crank Set Screw.....
300c	1852	" " " " " Screw Centre.....
1513E	1824	" " " " " Nut.....
11402	1805	Lifting Presser Bar.....
56502	1862	" " " Bell Crank.....
56503	—	" " " " " 56502 with 611f and 19810.....
8d	1851	Lifting Presser Bar Bell Crank Adjusting Hinge Screw.....
19310	1862	Lifting Presser Bar Bell Crank Adjusting Link with 1518E, 1828 and 2718.....
1828	1854	Lifting Presser Bar Bell Crank Adjusting Link Roller with 372c.....
372c	1851	Lifting Presser Bar Bell Crank Adjusting Link Roller Screw.....
1518E	1813	Lifting Presser Bar Bell Crank Adjusting Link Roller Screw Nut.....
2718	1826	Lifting Presser Bar Bell Crank Adjusting Link Roller Screw Nut Washer.....
611f	1889	Lifting Presser Bar Bell Crank Adjusting Link Screw.....
14586	1809	Lifting Presser Bar Guide Bracket with 159n, 453c and 460c.....
159d	1852	Lifting Presser Bar Guide Bracket Adjusting Screw.....
14587	1807	Lifting Presser Bar Guide Bracket Guide
381d	1851	" " " " " " " Screw.....
453c	1824	Lifting Presser Bar Guide Bracket Set Screw.....
11909	1806	Lifting Presser Bar Lifter with 8761 and 8763.....
8760	1826	Lifting Presser Bar Lifter Friction Washer
16d	1851	" " " " " Hinge Screw...
8761	1828	" " " " " Stop Pin.....
14588	1806	" " " " " Lifting Link.....

NO.	PLATE	NAME
353c	1854	Lifting Presser Bar Lifting Link Cap Screw.....
8763	1828	Lifting Presser Bar Lifting Link Hinge Stud.....
8973	1863	Lifting Presser Bar Lifting Link Hinge Stud Pin.....
8765	1826	Lifting Presser Bar Lifting Link Hinge Stud Washer.....
258E	1854	Lifting Presser Bar Screw Bushing.....
11409	1805	" " " Spring.....
11465	1815	" " " " Bracket with 353c.....
353c	1854	Lifting Presser Bar Spring Bracket Set Screw.....
11466	1826	Lifting Presser Bar Spring Bracket Set Screw Washer.....
56504	1868	Needle Bar.....
11539	1866	" " Connecting Link.....
566c	1851	" " " " Hinge Screw
1513E	1824	" " " " " " " Nut.....
11383	1814	Needle Bar Connecting Stud with two 445c.....
445c	1852	Needle Bar Connecting Stud Set Screw...
258E	1854	" " Screw Bushing.....
19702	1829	" Clamp with 680d and 11385.....
11385	1825	" " Gib.....
680d	1855	" " Thumb Screw.....
11497	1857	Oil Cup.....
11917	1857	" " Cover.....
9084	1828	" " " Hinge Pin.....
2205	1825	" " " Latch Spring.....
207f	1852	" " " " " Screw.....
11919	1829	" " Thread Eyelet.....
8953	1826	" or Wax Stripper (felt).....
8482	1826	" " " " Washer (steel) for 11497.....
11918	1825	Oil or Wax Stripper Washer (steel) for 11917.....
207f	1852	Oil or Wax Stripper Washer Screw.....
11921	1857	Oil Cup complete, Nos. 2205, 8482, 9084, 11497, 11917 to 11919, two 8953 and three 207f.....
134d	1852	Oil Cup Screw.....
56534	1804	Oscillating Rock Shaft (steel).....
56535	—	Oscillating Rock Shaft complete, Nos. 622c, 11165, 11398, 56534 and two 1508E

NO.	PLATE	NAME
11398	1804	Oscillating Rock Shaft Hinge Pin.....
1508E	1101	" " " " " Nut....
622c	1854	" " " " " Screw
		Bearing.....
1508E	1101	Oscillating Rock Shaft Hinge Pin Screw
		Bearing Nut.....
11165	1826	Oscillating Rock Shaft Oil Pad.....
14589	1800	" Shaft.....
11848	—	" Crank.....
19696	1824	Oscillating Shaft Crank complete, Nos. 453c, 1513E, 5868 and 11848.....
2117	1828	Oscillating Shaft Crank Pin.....
453c	1824	" " " " Set Screw.....
9119	1824	" " " " Slide Block.....
5868	1824	Oscillating Shaft Crank Slide Block com- plete, Nos. 190D, 1054c, 5968 and 9119.
190D	1824	Oscillating Shaft Crank Slide Block Cap Screw.....
5968	1824	Oscillating Shaft Crank Slide Block Cap Screw Washer.....
1054c	1824	Oscillating Shaft Crank Slide Block Screw Stud.....
1513E	1824	Oscillating Shaft Crank Slide Block Screw Stud Nut.....
252E	1854	Pressure Regulating Thumb Screw.....
14535	1821	Shuttle Bobbin.....
12093	1820	" Cylinder.....
12000	1819	" " Hinge Pin.....
12001	1821	" " Latch.....
2027	1821	" " " Pin.....
11854	1821	" " " Spring.....
590E	1821	" " " " Screw.....
12094	1820	" Frame.....
773c	1820	" Tension Regulating Screw.....
12095	1820	" " Spring.....
12092	1820	Shuttle (cylinder) 2½ in. diam., complete, Nos. 590E, 773c, 2027, 11854, 12000, 12001, 12093 to 12095 and 14535.....
12006	1821	Shuttle Driver and Feed Lifting Cam....
2049	1828	" " " " " Pin.....
14554	1818	" Race.....
141c	1852	" " Screw.....
19542	1814	Tension Bracket.....
190D	1824	" " Screw.....
8879	1827	" Friction Washer (cloth).....
11423	1826	" " " (steel).....
1560c	1854	" Regulating Thumb Nut.....

NO.	PLATE	NAME
8905	1827	Tension Regulating Thumb Nut Washer
411D	1855	" Screw Stud.....
11422	1827	" Spring.....
11044	1827	" Wheel.....
11420	—	Tension (wheel) complete, Nos. 411D, 1560c, 8905, 11044, 11422, 11423 and two 8879.....
11950	1829	Thread Eyelet.....
2102	1827	" Retaining Disc.....
1560c	1854	" " Regulating Thumb Nut
8905	1827	" " " " " "
		Washer.....
686D	1855	Thread Retaining Screw Stud.....
2103	1827	" " Spring.....
11041	—	Thread Retainer complete, Nos. 686D, 1560c, 2103, 8905 and two 2102.....
14590	1808	Thread Take-up Cam with two 434c....
8873	1828	" " " Pin.....
434c	1852	" " " Set Screw.....
11845	1807	" " Lever with 1995.....
567D	1851	" " " Hinge Screw.....
1995	1889	" " " Roller and Screw Stud with 1518E.....
1518E	1813	Thread Take-up Lever Roller and Screw Stud Nut.....
11052	1827	Thread Take-up Spring.....
11431	1827	" " " Regulator Plate
190D	1824	" " " " "
		Adjusting Screw.....
19543	1869	Thread Take-up Spring Staple.....
690D	1889	" " " " Screw.....
41544	1826	" " " " Washer
14684	1883	Throat Plate for 14727.....
14667	1850	" " " 14725.....
14670	1850	" " " 14726.....
14677	1849	" " Holder.....
389F	1851	" " " Screw.....
202D	1852	" " Screw (long).....
228D	1852	" " " (short).....
14679	1868	Vibrating Presser Bar.....
14593	1809	" " " Guide Bracket with 448c.....
14594	—	Vibrating Presser Bar Guide Bracket com- plete, Nos. 231c, 11472, 14593, 14595 and two 190D.....
14595	1809	Vibrating Presser Bar Guide Bracket Cap

NO.	PLATE	NAME
190b	1824	Vibrating Presser Bar Guide Bracket Cap Screw.....
2117	1828	Vibrating Presser Bar Guide Bracket Pin.
448c	1852	" " " " " Set Screw.....
14596	1828	Vibrating Presser Bar Hinge Pin.....
460c	1852	" " " " " S e t Screw.....
11471	1829	Vibrating Presser Bar Spring.....
11472	1829	" " " " B r a c k e t
231c	1852	" " " " " Screw.....
56505	1883	Vibrating Presser Foot for 14725.....
56506	1883	" " " " 14726.....
56507	1883	" " " " 14727.....
898d	1852	" " " " Screw.....
1547d	1854	" " " " Nut.....

For Driving Attachment Parts, see Page 100

SINGER Needles should be used  
in SINGER Machines.  
These Needles and their Containers  
are marked with the  
Company's Trade Mark "SIMANCO.\*\*" 1

Needles in Containers marked  
"FOR SINGER MACHINES"  
are NOT **SINGER** made needles. 2

## LIST OF PARTS COMPLETE FOR MACHINE NO. 11-16

FOR OVERSEAMING LONG BOOT LEGS OR OTHER TUBULAR ARTICLES  
WHILE FEEDING UP THE ARM, OR FOR STRAIGHT STITCHING  
WHILE FEEDING ACROSS THE ARM, DROP FEED; HAS PARTS  
TO CHANGE FROM ONE STYLE TO THE OTHER AND  
BALANCE WHEEL NO. 11356 FOR UNDER DRIVER;  
30 INCHES FROM NEEDLE TO BASE OF ARM

NO.	PLATE	NAME
*14734	—	Arm with 65d and 14578.....
8702	1828	" Dowel Pin.....
496E	1853	" Screw.....
14786	1867	" Shaft.....
11354	1809	" " Bushing.....
437c	1852	" " " Set Screw.....
14606	1804	" " Gear with two 445c.....
3012	1828	" " " Pin.....
445c	1852	" " " Set Screw.....
14578	1857	" Side Cover.....
65d	1851	" " " Hinge Screw.....
14579	1801	" " Wheel with two 446c.....
446c	1852	" " " Set Screw.....
14607	1804	" " " Shaft.....
14608	1804	" " " " Gear with 453c...
2117	1828	" " " " " Pin.....
453c	1824	" " " " " Set Screw....
144d	1852	" " " " " Screw.....
8708	1828	" Spool Pin.....
11241	1863	" " " Washer (cloth)...per 100
11356	1801	Balance Wheel with two 354c.....
8937	1863	" " " Pin.....
354c	1101	" " " Set Screw.....
11363	1802	Crank Connecting Rod with 11364 and two 145E.....
*11364	—	Crank Connecting Rod Cap.....
145E	1852	" " " " " Screw.....
565c	1851	" " " " Hinge Screw.....
1513E	1824	" " " " " Nut..
*14609	—	Cylinder, 3½ in. diam.....
11367	1803	Feed Cam with two 445c.....
445c	1852	" " " Set Screw.....

NO.	PLATE	NAME
11368	1803	Feed Connecting Link.....
565c	1851	" " " Hinge Screw.....
1513e	1824	" " " " " Nut..
12081	1846	" Dog for 14506.....
14716	1881	" " (left of needle) for 14715.....
14722	1881	" " (right of needle) for 14715.....
14733	1866	" " Adjusting Piece.....
14715	1866	" " " " Carrier.....
792c	1813	" " " " Screw.....
176d	1852	" " Screw.....
14502	1802	" Forked Connection.....
565c	1851	" " " Hinge Screw....
1513e	1824	" " " " " Nut
6132	1813	" " " Universal Joint
212c	1813	" " " " " "
		Cap Screw.....
23c	1851	Feed Forked Connection Universal Joint Hinge Screw.....
14583	1803	Feed Regulator.....
568e	1851	" " Hinge Screw.....
254d	1813	" " Thumb Screw.....
14525	1801	" Rock Shaft.....
14504	1803	" " " for 300c.....
14505	1803	" " " Arm with 436c.....
2117	1828	" " " " Pin.....
436c	1852	" " " " Set Screw.....
4448	1828	" " " Back Bearing Oil Tube.
14526	1803	" " " Crank (forked) with 445c, for 14525.....
14522	1803	Feed Rock Shaft Crank with 445c, for 14524.....
14524	—	Feed Rock Shaft Crank complete for 14504, Nos. 164d, 6312, 14522 and 14523.....
3012	1828	Feed Rock Shaft Crank Pin for 14526....
2117	1828	" " " " " " 14522....
14523	1825	" " " " Roller.....
164d	1852	" " " " " Cap Screw
6312	1826	" " " " " " "
		Washer.....
445c	1852	Feed Rock Shaft Crank Set Screw.....
300c	1852	" " " Screw Centre.....
1513e	1824	" " " " " Nut.....
14506	1801	" Rod.....
23c	1851	" " Hinge Screw.....
14501	1825	" " Spring.....
219d	1889	" " " Screw.....

NO.	PLATE	NAME
11538	1870	Needle Bar.....
11539	1866	" " Connecting Link.....
566c	1851	" " " " Hinge Screw
1513e	1824	" " " " " "
		Nut.....
11383	1814	Needle Bar Connecting Stud with two 445c.....
445c	1852	Needle Bar Connecting Stud Set Screw..
14728	1870	" " Frame with 190d and 14732..
14610	1811	" " " Cam.....
14611	—	Needle Bar Frame Cam complete, Nos. 14610, 14612 and two 159d.....
14612	1811	Needle Bar Frame Cam Bevel Gear....
567d	1851	" " " " " " Screw
14613	1811	" " " " Cover.....
202d	1852	" " " " " Screw....
159d	1852	" " " " Screw.....
14614	1811	" " " Driving Bevel Pinion with two 445c.....
445c	1852	Needle Bar Frame Driving Bevel Pinion Set Screw.....
14615	1828	Needle Bar Frame Hinge Pin.....
435c	1852	" " " " " Set Screw..
14729	1870	" " " Pitman.....
1371c	1889	" " " " Hinge Screw..
14730	1871	" " " " " Stud...
14731	1871	" " " " " " Col- lar with 448c.....
448c	1871	Needle Bar Frame Pitman Hinge Stud Collar Set Screw.....
14534	1811	Needle Bar Frame Regulator with 1813 and two 212d.....
1086e	1854	Needle Bar Frame Regulator Adjusting Screw.....
14616	1825	Needle Bar Frame Regulator Adjusting Screw Sleeve.....
212d	1813	Needle Bar Frame Regulator Adjusting Screw Stop Screw.....
1639d	1854	Needle Bar Frame Regulator Adjusting Screw Thumb Nut.....
1813	1854	Needle Bar Frame Regulator Roller and Stud.....
164d	1852	Needle Bar Frame Regulator Screw....
41544	1826	" " " " " Washer
14732	1871	" " " Thread Guard.....
190d	1824	" " " " " Screw..
56522	1869	" " " Washer (steel).....



NO.	PLATE	NAME
19702	1829	Needle Clamp with 680D and 11385.....
11385	1825	" " Gib.....
680D	1855	" " Thumb Screw.....
11497	1857	Oil Cup.....
11917	1857	" " Cover.....
9084	1828	" " " Hinge Pin.....
2205	1825	" " " Latch Spring.....
207F	1852	" " " " Screw.....
11919	1829	" " Thread Eyelet.....
8953	1826	" or Wax Stripper (felt).....
8482	1826	" " " " Washer (steel) for 11497.....
11918	1825	Oil or Wax Stripper Washer (steel) for 11917.....
207F	1852	Oil or Wax Stripper Washer Screw.....
11921	1857	Oil Cup complete, Nos. 2205, 8482, 9084, 11497, 11917 to 11919, two 8953 and three 207F.....
134D	1852	Oil Cup Screw.....
56534	1804	Oscillating Rock Shaft (steel).....
56535	—	Oscillating Rock Shaft complete, Nos. 622c, 11165, 11398, 56534 and two 1508E.....
11398	1804	Oscillating Rock Shaft Hinge Pin.....
1508E	1101	" " " " Nut....
622c	1854	" " " " " Screw Bearing.....
1508E	1101	Oscillating Rock Shaft Hinge Pin Screw Bearing Nut.....
11165	1826	Oscillating Rock Shaft Oil Pad.....
56523	1867	" Shaft with 2049 and 56524....
11848	—	" Crank.....
19696	1824	Oscillating Shaft Crank complete, Nos. 453c, 1513E, 5868 and 11848.....
2117	1828	Oscillating Shaft Crank Pin.....
453c	1824	" " " Set Screw.....
9119	1824	" " " Slide Block.....
5868	1824	Oscillating Shaft Crank Slide Block com- plete, Nos. 190D, 1054c, 5968 and 9119.
190D	1824	Oscillating Shaft Crank Slide Block Cap Screw.....
5968	1824	Oscillating Shaft Crank Slide Block Cap Screw Washer.....
1054c	1824	Oscillating Shaft Crank Slide Block Screw Stud.....
1513E	1824	Oscillating Shaft Crank Slide Block Screw Stud Nut.....

NO.	PLATE	NAME
*56524	—	Oscillating Shaft Sleeve.....
2049	1828	" " " Pin.....
14603	1805	Presser Bar.....
14532	1809	" " Guide Bracket with 145D and 445c.....
145D	1852	Presser Bar Guide Bracket Adjusting Screw.....
14617	1807	Presser Bar Guide Bracket Guide with 2022.....
381D	1851	Presser Bar Guide Bracket Guide Screw..
445c	1852	" " " " Set Screw....
14761	1870	" " Lifter.....
8760	1826	" " " Friction Washer.....
50063D	1889	" " " Hinge Screw.....
1513E	1824	" " " " " Nut.....
194D	1889	" " " Screw Stud.....
2022	1828	" " " Stop Pin.....
11991	1805	" " Spring.....
11411	1825	" " " Collar with 453c....
453c	1824	" " " Set Screw.....
12083	1846	" Foot for 12081.....
12082	1846	" " ".....
14559	1838	" " (left of needle) for 14716....
14558	1838	" " (right of needle) for 14722..
176D	1852	" " Screw.....
14535	1821	Shuttle Bobbin.....
14528	1822	" Cylinder.....
12000	1819	" " Hinge Pin.....
14529	1822	" " Latch.....
2027	1821	" " " Pin.....
11854	1821	" " " Spring.....
590E	1821	" " " Screw....
14530	1822	" Frame.....
774c	1821	" Tension Regulating Screw.....
14531	1822	" " Spring.....
14527	1822	Shuttle (cylinder) 2½ in. diam., complete, Nos. 590E, 774c, 2027, 11854, 12000, 14528 to 14531 and 14535.....
56525	1872	Shuttle Driver and Feed Lifting Cam... 2049 1828 " " " " " Pin.
14618	1818	" Race.....
141c	1852	" " Screw.....
14766	1871	Tension (lower) Bracket.....
190D	1824	" " " Screw.....
8879	1827	" " Friction Washer (cloth)..
11043	1826	" " " (steel)...
1560c	1854	" " Regulating Thumb Nut

NO.	PLATE	NAME
8905	1827	Tension (lower) Regulating Thumb Nut Washer.....
632D	1855	Tension (lower) Screw Stud.....
8791	1827	" " Spring.....
11044	1827	" " Wheel.....
2102	1827	" (upper) Disc.....
1560C	1854	" " Regulating Thumb Nut
8905	1827	" " " " " "
		Washer.....
14767	1871	Tension (upper) Releaser.....
14768	1862	" " " Body.....
14769	1871	" " " " Block
		(lower).....
401D	1851	Tension (upper) Releaser Body Block
		(lower) Screw.....
14770	1871	Tension (upper) Releaser Body Block
		(upper).....
401D	1851	Tension (upper) Releaser Body Block
		(upper) Screw.....
756D	1871	Tension (upper) Releaser Screw.....
14771	---	Tension (upper) Releaser complete, Nos. 14767 to 14770, two 756D and four 401D
50064D	1889	Tension (upper) Screw Stud.....
2103	1827	" " Spring.....
11950	1829	" " Thread Eyelet.....
14621	1808	Thread Take-up Cam with two 434C....
8873	1828	" " " Pin.....
434C	1852	" " " Set Screw.....
14623	1807	" " Lever with 1995.....
567D	1851	" " " Hinge Screw.....
1995	1889	" " " Roller and Screw
		Stud with 1518E.....
1518E	1813	Thread Take-up Lever Roller and Screw
		Stud Nut.....
8798	1827	Thread Take-up Spring.....
14624	1827	" " " Regulator Plate
190D	1824	" " " " " "
		Adjusting Screw.....
14772	1869	Thread Take-up Spring Staple.....
690D	1889	" " " " Screw.....
41544	1826	" " " " " Washer
12084	1846	Throat Plate for 12081.....
14520	1838	" " " 14716.....
14521	1838	" " " 14722.....
14519	1837	" " Holder.....
389F	1851	" " " Screw.....
202D	1852	" " Screw (long).....
228D	1852	" " " (short).....

## MACHINE NO. 11-17

FOR MILITARY BOOT LEGS AND SIMILAR TUBULAR WORK. HAS  
DROP FEED UP THE ARM AND PARTS TO CHANGE TO FEED  
ACROSS THE ARM

This Machine is the same as No. 11-13 with the following exceptions:

NO.	PLATE	NAME
14716	1881	Feed Dog (left of needle) for 14715, in place of 14564.....
14570	1882	Feed Dog (double).....
14559	1838	Presser Foot (left of needle) for 14716, in place of 14567.....
14680	1882	Presser Foot (short right toe) for 14570..
11994	1840	Roller Arm for 11992, in place of 12031..
14551	1842	" " " 14553.....
11995	1840	" " Bracket for 11992, in place of 12032.....
14552	1842	Roller Arm Bracket for 14553.....
207F	1852	" " Lock Spring Screw, in place of 176D and 1549D.....
14553	1842	Roller Presser (left of needle) 1¼ in. roller, complete, Nos. 207F, 440F, 1899, 2205, 14551, 14552, two 316F and three 1547D.....
11992	1840	Roller Presser (right of needle) 1¼ in. roller, complete, Nos. 207F, 440F, 1899, 2205, 11994, 11995, two 316F and three 1547D, in place of 12030.....
14520	1838	Throat Plate for 14716, in place of 14568.
14681	1882	" " (rounded edges) for 14570..

**LIST OF PARTS COMPLETE  
FOR  
MACHINE NO. 11-18**

**FOR LEATHER. DROP FEED ACROSS THE ARM, HAS ALTERNATING  
PRESSERS**

NO.	PLATE	NAME
*12036	—	Arm with 65d and 14710.....
8702	1828	" Dowel Pin.....
338E	1853	" Screw.....
12085	1800	" Shaft.....
11954	1809	" " Bushing.....
446c	1852	" " " Set Screw.....
6804	1804	" " Gear with 453c.....
2117	1828	" " " Pin.....
453c	1824	" " " Set Screw.....
144d	1852	" " Screw.....
14710	1862	" Side Cover.....
65d	1851	" " " Hinge Screw.....
11957	1801	" " Wheel with two 446c.....
446c	1852	" " " Set Screw.....
6805	1804	" " " Shaft.....
6806	1804	" " " " Gear with 453c....
2117	1828	" " " " " Pin.....
453c	1824	" " " " " Set Screw...
144d	1852	" " " " " Screw.....
8708	1828	" Spool Pin.....
11241	1863	" " " Washer (cloth).... per 100
11960	1801	Balance Wheel with two 354c.....
354c	1101	" " Set Screw.....
12096	1802	Crank Connecting Rod with 14541 and two 145E.....
*14541	—	Crank Connecting Rod Cap.....
145E	1852	" " " " Screw.....
565c	1851	" " " " Hinge Screw.....
1513E	1824	" " " " " Nut..
*14662	—	Cylinder, 3 1/8 in. diam.....
3032	1803	Feed Cam with 446c.....
446c	1852	" " Set Screw.....
3033	1813	" Connecting Link.....
375c	1813	" " " Hinge Screw.....
1518E	1813	" " " " " Nut..
14721	1881	" Dog.....
14715	1866	" " Carrier.....

NO.	PLATE	NAME
792c	1813	Feed Dog Screw.....
12097	1802	" Forked Connection.....
372c	1851	" " " " Hinge S c r e w (lower).....
375c	1813	Feed Forked Connection Hinge Screw (upper).....
1518E	1813	Feed Forked Connection Hinge Screw Nut.....
12091	1813	Feed Regulator.....
58E	1813	" " " Hinge Screw.....
254d	1813	" " " Thumb Screw.....
12087	1801	" Rock Shaft.....
14630	—	Feed Rock Shaft complete, Nos. 12087 and 14631.....
4448	1828	Feed Rock Shaft Back Bearing Oil Tube.
14631	1803	" " " Crank with 453c.....
2117	1828	" " " " Pin.....
453c	1824	" " " " " Set Screw.....
11475	1805	Lifting Presser Bar.....
11476	1810	" " " Bell Crank.....
166d	1855	" " " " " H i n g e Cap Screw.....
1851	1851	Lifting Presser Bar Bell Crank Lifting Roller with 610d.....
610d	1852	Lifting Presser Bar Bell Crank Lifting Roller Screw.....
1518E	1813	Lifting Presser Bar Bell Crank Lifting Roller Screw Nut.....
2718	1826	Lifting Presser Bar Bell Crank Lifting Roller Screw Nut Washer.....
11478	1810	Lifting Presser Bar Bracket with two 145F.....
145F	1852	Lifting Presser Bar Bracket Clamping Screw.....
11909	1806	Lifting Presser Bar Lifter with 8761 and 8763.....
8760	1826	Lifting Presser Bar Lifter Friction Washer
16d	1851	" " " " Hinge Screw...
8761	1828	" " " " Stop Pin.....
11907	1806	" " " " Lifting Link.....
166d	1855	" " " " " C a p Screw.....
8763	1828	Lifting Presser Bar Lifting Link Hinge Stud.....
7958	1828	Lifting Presser Bar Lifting Link Hinge Stud Pin.....

NO.	PLATE	NAME
8765	1826	Lifting Presser Bar Lifting Link Hinge Stud Washer.....
11479	1810	Lifting Presser Bar Rock Shaft.....
11480	1810	" " " " Adjusting Arm with 190D.....
2117	1828	Lifting Presser Bar Rock Shaft Adjusting Arm Pin.....
190D	1824	Lifting Presser Bar Rock Shaft Adjusting Arm Set Screw.....
11481	1810	Lifting Presser Bar Rock Shaft Bracket
2002	1828	" " " " " "
		Dowel Pin (lower).....
4389	1828	Lifting Presser Bar Rock Shaft Bracket Dowel Pin (upper).....
123E	1852	Lifting Presser Bar Rock Shaft Bracket Screw.....
11484	1810	Lifting Presser Bar Rock Shaft Crank with 453c and 1850.....
2117	1828	Lifting Presser Bar Rock Shaft Crank Pin.....
1850	1854	Lifting Presser Bar Rock Shaft Crank Roller and Stud.....
453c	1824	Lifting Presser Bar Rock Shaft Crank Set Screw.....
11486	1810	Lifting Presser Bar Rock Shaft Eccentric Strap with two each 141F and 1528D...
141F	1852	Lifting Presser Bar Rock Shaft Eccentric Strap Adjusting Screw.....
1528D	1854	Lifting Presser Bar Rock Shaft Eccentric Strap Adjusting Screw Nut.....
608c	1851	Lifting Presser Bar Rock Shaft Eccentric Strap Hinge Screw.....
1518E	1813	Lifting Presser Bar Rock Shaft Eccentric Strap Hinge Screw Nut.....
11487	1825	Lifting Presser Bar Rock Shaft Eccentric Strap Hinge Screw Slide.....
11488	1826	Lifting Presser Bar Rock Shaft Eccentric Strap Hinge Screw Slide Washer.....
258E	1854	Lifting Presser Bar Screw Bushing.....
11489	1810	" " " Sleeve (lower).....
11490	1810	" " " " (upper).....
11491	—	" " " " " 11490 with 11492.....
11492	1825	Lifting Presser Bar Sleeve (upper) Cap...
11493	1801	" " " Spring (flat).....
56518	1870	" " " " Bracket.....
138E	1101	" " " " " Screw.....

NO.	PLATE	NAME
11495	1829	Lifting Presser Bar Spring Bracket Thread Eyelet.....
190D	1824	Lifting Presser Bar Spring Bracket Thread Eyelet Screw.....
4389	1828	Lifting Presser Bar Spring Guide Pin.....
14538	1839	" " " Foot with 211F.....
2049	1828	" " " Pin.....
211F	1852	" " " Set Screw.....
11380	1805	Needle Bar.....
11539	1866	" " Connecting Link.....
566c	1851	" " " " Hinge Screw
1513E	1824	" " " " " "
		Nut.....
11383	1814	Needle Bar Connecting Stud with two 445c.....
445c	1852	Needle Bar Connecting Stud Set Screw.
258E	1854	" " Screw Bushing.....
19702	1829	" Clamp with 680D and 11385.....
11385	1825	" " Gib.....
680D	1855	" " Thumb Screw.....
11497	1857	Oil Cup.....
11917	1857	" " Cover.....
9084	1828	" " " Hinge Pin.....
2205	1825	" " " Latch Spring.....
207F	1852	" " " " Screw.....
11919	1829	" " Thread Eyelet.....
8953	1826	" or Wax Stripper (felt).....
8482	1826	" " " Washer (steel) for 11497.....
11918	1825	Oil or Wax Stripper Washer (steel) for 11917.....
207F	1852	Oil or Wax Stripper Washer Screw.....
11921	1857	Oil Cup complete, Nos. 2205, 8482, 9084, 11497, 11917 to 11919, two 8953 and three 207F.....
134D	1852	Oil Cup Screw.....
12090	1804	Oscillating Rock Shaft with 11165.....
11164	1804	" " " Hinge Pin.....
435c	1852	" " " " " S e t Screw.....
11165	1826	Oscillating Rock Shaft Oil Pad.....
14632	1800	" Shaft.....
12088	—	" " Crank.....
14633	1823	Oscillating Shaft Crank complete, Nos. 453c, 1513E, 5868 and 12088.....
2117	1828	Oscillating Shaft Crank Pin.....
453c	1824	" " " Set Screw.....

NO.	PLATE	NAME
9119	1824	Oscillating Shaft Crank Slide Block.....
5868	1824	Oscillating Shaft Crank Slide Block complete, Nos. 190D, 1054c, 5968 and 9119.
190D	1824	Oscillating Shaft Crank Slide Block Cap Screw.....
5968	1824	Oscillating Shaft Crank Slide Block Cap Screw Washer.....
1054c	1824	Oscillating Shaft Crank Slide Block Screw Stud.....
1513E	1824	Oscillating Shaft Crank Slide Block Screw Stud Nut.....
609D	1855	Pressure Regulating Thumb Screw.....
14535	1821	Shuttle Bobbin.....
12093	1820	" Cylinder.....
12000	1819	" " Hinge Pin.....
12001	1821	" " Latch.....
2027	1821	" " Pin.....
11854	1821	" " Spring.....
590E	1821	" " " " Screw.....
12094	1820	" Frame.....
773c	1820	" Tension Regulating Screw.....
12095	1820	" " Spring.....
12092	1820	Shuttle (cylinder) 2½ in. diam., complete, Nos. 590E, 773c, 2027, 11854, 12000, 12001, 12093 to 12095 and 14535.....
12006	1821	Shuttle Driver and Feed Lifting Cam....
2049	1828	" " " " " " Pin.....
14554	1818	" Race.....
141c	1852	" " Screw.....
11502	1809	Tension Bracket and Vibrating Presser Bar Cap with 11424.....
11501	—	Tension Bracket and Vibrating Presser Bar Cap complete, Nos. 122D, 9525, 11502, 11506, 11936, 11937, 12042 and two 190D.....
159F	1852	Tension Bracket and Vibrating Presser Bar Cap Screw (left).....
145F	1852	Tension Bracket and Vibrating Presser Bar Cap Screw (right).....
8879	1827	Tension Friction Washer (cloth).....
11423	1826	" " " (steel).....
1560c	1854	" Regulating Thumb Nut.....
8905	1827	" " " " Washer..
607D	1855	" Screw Stud.....
122D	1852	" " Clamping Screw.....
8791	1827	" Spring.....
11044	1827	" Wheel.....

NO.	PLATE	NAME
12042	—	Tension (wheel) complete, Nos. 607D, 1560c, 8791, 8905, 11044, 11423 and two 8879.....
11424	1829	Thread Eyelet (front of arm) for 11502..
11950	1829	" " (side of arm) for 11503....
2102	1827	" Retaining Disc.....
1560c	1854	" " Regulating Thumb Nut
8905	1827	" " " " " "
		Washer.....
606D	1855	Thread Retaining Screw Stud.....
2103	1827	" " Spring.....
11503	—	Thread Retainer complete, Nos. 606D, 1560c, 2103, 8905 and two 2102.....
12044	1808	Thread Take-up Cam with two 434c.....
8873	1828	" " " Pin.....
434c	1852	" " " Set Screw.....
11845	1807	" " Lever with 1995.....
567D	1851	" " " Hinge Screw.....
1995	1889	" " " Roller and Screw Stud with 1518E.....
1518E	1813	Thread Take-up Lever Roller and Screw Stud Nut.....
11506	1827	Thread Take-up Spring.....
11936	1827	" " " Regulator Plate
190D	1824	" " " " " "
		Adjusting Screw.....
11937	1829	Thread Take-up Spring Staple.....
9525	1826	" " " " Washer....
14663	—	Throat Plate Body.....
14563	1841	" " Needle Hole Strip.....
401D	1851	" " " " " Screw...
14664	1839	Throat Plate complete for 14721, Nos. 14563, 14663 and two 401D.....
14519	1837	Throat Plate Holder.....
389F	1851	" " " Screw.....
202D	1852	" " " Screw (long).....
228D	1852	" " " (short).....
11508	1809	Vibrating Presser Bar.....
11509	1826	" " " Cushion (rawhide).
233D	1852	" " " " Screw.....
14601	1810	" " " Hinge Bracket with 145F.....
145F	1852	Vibrating Presser Bar Hinge Bracket Adjusting Screw.....
164D	1852	Vibrating Presser Bar Hinge Cap Screw
41544	1826	" " " " " " Washer.....

NO.	PLATE	NAME
11512	1825	Vibrating Presser Bar Spring.....
11939	1829	“ “ “ “ Adjusting Staple.....
190D	1824	Vibrating Presser Bar Spring Adjusting Staple Screw.....
223D	1819	Vibrating Presser Bar Spring Screw.....
11513	1839	“ “ Foot.....
191c	1852	“ “ “ Screw.....

### LIST OF PARTS COMPLETE

FOR

### MACHINE NO. 11-19

FOR LEATHER. DROP FEED ACROSS THE ARM, HAS VIBRATING  
PRESSER

NO.	PLATE	NAME
*14636	—	Arm with 65D and 14710.....
8702	1828	“ Dowel Pin.....
338E	1853	“ Screw.....
12085	1800	“ Shaft.....
11954	1809	“ “ Bushing.....
446c	1852	“ “ “ Set Screw.....
6804	1804	“ “ Gear with 453c.....
2117	1828	“ “ “ Pin.....
453c	1824	“ “ “ Set Screw.....
144D	1852	“ “ Screw.....
14710	1862	“ Side Cover.....
65D	1851	“ “ “ Hinge Screw.....
11957	1801	“ “ Wheel with two 446c.....
446c	1852	“ “ “ Set Screw.....
6805	1804	“ “ “ Shaft.....
6806	1804	“ “ “ “ Gear with 453c.....
2117	1828	“ “ “ “ “ Pin.....
453c	1824	“ “ “ “ “ Set Screw.....
144D	1852	“ “ “ “ “ Screw.....
8708	1828	“ Spool Pin.....
11241	1863	“ “ “ Washer (cloth).....per 100
11960	1801	Balance Wheel with two 354c.....
354c	1101	“ “ “ Set Screw.....
12096	1802	Crank Connecting Rod with 14541 and two 145E.....

NO.	PLATE	NAME
*14541	—	Crank Connecting Rod Cap.....
145E	1852	“ “ “ “ Screw.....
565c	1851	“ “ “ Hinge Screw.....
1513E	1824	“ “ “ “ Nut..
*14662	—	Cylinder, 3¼ in. diam.....
3032	1803	Feed Cam with 446c.....
446c	1852	“ “ Set Screw.....
3033	1813	“ Connecting Link.....
375c	1813	“ “ “ Hinge Screw.....
1518E	1813	“ “ “ “ “ Nut..
14721	1881	“ Dog.....
14715	1866	“ “ Carrier.....
792c	1813	“ “ Screw.....
12097	1802	“ Forked Connection.....
372c	1851	“ “ “ Hinge Screw (lower).....
375c	1813	Feed Forked Connection Hinge Screw (upper).....
1518E	1813	Feed Forked Connection Hinge Screw Nut.....
12091	1813	Feed Regulator.....
58E	1813	“ “ Hinge Screw.....
254D	1813	“ “ Thumb Screw.....
12087	1801	“ Rock Shaft.....
14630	—	Feed Rock Shaft complete, Nos. 12087 and 14631.....
4448	1828	Feed Rock Shaft Back Bearing Oil Tube.
14631	1803	“ “ “ Crank with 453c.....
2117	1828	“ “ “ “ Pin.....
453c	1824	“ “ “ “ Set Screw.....
11402	1805	Lifting Presser Bar.....
12048	1807	“ “ “ Bell Crank with 1518E, 1828 and 2718.....
8D	1851	Lifting Presser Bar Bell Crank Hinge Screw.....
1828	1854	Lifting Presser Bar Bell Crank Roller with 372c.....
372c	1851	Lifting Presser Bar Bell Crank Roller Screw.....
1518E	1813	Lifting Presser Bar Bell Crank Roller Screw Nut.....
2718	1826	Lifting Presser Bar Bell Crank Roller Screw Nut Washer.....
14586	1809	Lifting Presser Bar Guide Bracket with 159D, 453c and 460c.....
159D	1852	Lifting Presser Bar Guide Bracket Ad- justing Screw.....

NO.	PLATE	NAME
56516	1862	Lifting Presser Bar Guide Bracket Guide
134D	1852	" " " " " "
		Screw (lower).....
123D	1852	Lifting Presser Bar Guide Bracket Guide
		Screw (upper).....
453c	1824	Lifting Presser Bar Guide Bracket Set
		Screw.....
11909	1806	Lifting Presser Bar Lifter with 8761 and
		8763.....
8760	1826	Lifting Presser Bar Lifter Friction Washer
16D	1851	" " " " Hinge Screw...
8761	1828	" " " " Stop Pin.....
11906	1806	" " " " Lifting Link.....
353c	1854	" " " " Cap Screw
8763	1828	" " " " H i n g e
		Stud.....
7958	1828	Lifting Presser Bar Lifting Link Hinge
		Stud Pin.....
8765	1826	Lifting Presser Bar Lifting Link Hinge
		Stud Washer.....
258E	1854	Lifting Presser Bar Screw Bushing.....
11409	1805	" " " Spring.....
11465	1815	" " " " Bracket with
		353c.....
353c	1854	Lifting Presser Bar Spring Bracket Set
		Screw.....
11466	1826	Lifting Presser Bar Spring Bracket Set
		Screw Washer.....
11380	1805	Needle Bar.....
11539	1866	" " Connecting Link.....
566c	1851	" " " " Hinge Screw
1513E	1824	" " " " " "
		Nut.....
11383	1814	Needle Bar Connecting Stud with two
		445c.....
445c	1852	Needle Bar Connecting Stud Set Screw..
258E	1854	" " Screw Bushing.....
19702	1829	" Clamp with 680D and 11385.....
11385	1825	" " Gib.....
680D	1855	" " Thumb Screw.....
11497	1857	Oil Cup.....
11917	1857	" " Cover.....
9084	1828	" " " Hinge Pin.....
2205	1825	" " " Latch Spring.....
207F	1852	" " " " " Screw.....
11919	1829	" " Thread Eyelet.....
8953	1826	" or Wax Stripper (felt).....

NO.	PLATE	NAME
8482	1826	Oil or Wax Stripper Washer (steel) for
		11497.....
11918	1825	Oil or Wax Stripper Washer (steel) for
		11917.....
207F	1852	Oil or Wax Stripper Washer Screw.....
11921	1857	Oil Cup complete, Nos. 2205, 8482, 9084,
		11497, 11917 to 11919, two 8953 and
		three 207F.....
134D	1852	Oil Cup Screw.....
12090	1804	Oscillating Rock Shaft with 11165.....
11164	1804	" " " Hinge Pin.....
435c	1852	" " " " " S e t
		Screw.....
11165	1826	Oscillating Rock Shaft Oil Pad.....
14632	1800	" Shaft.....
12088	—	" " Crank.....
14633	1823	Oscillating Shaft Crank complete, Nos.
		453c, 1513E, 5868 and 12088.....
2117	1828	Oscillating Shaft Crank Pin.....
453c	1824	" " " Set Screw.....
9119	1824	" " " Slide Block.....
5868	1824	Oscillating Shaft Crank Slide Block com-
		plete, Nos. 190D, 1054c, 5968 and 9119.
190D	1824	Oscillating Shaft Crank Slide Block Cap
		Screw.....
5968	1824	Oscillating Shaft Crank Slide Block Cap
		Screw Washer.....
1054c	1824	Oscillating Shaft Crank Slide Block Screw
		Stud.....
1513E	1824	Oscillating Shaft Crank Slide Block Screw
		Stud Nut.....
252E	1854	Pressure Regulating Thumb Screw.....
14535	1821	Shuttle Bobbin.....
12093	1820	" Cylinder.....
12000	1819	" " Hinge Pin.....
12001	1821	" " Latch.....
2027	1821	" " " Pin.....
11854	1821	" " " Spring.....
590E	1821	" " " " Screw.....
12094	1820	" Frame.....
773c	1820	" Tension Regulating Screw.....
12095	1820	" " Spring.....
12092	1820	Shuttle (cylinder) 2½ in. diam., complete,
		Nos. 590E, 773c, 2027, 11854, 12000,
		12001, 12093 to 12095 and 14535.....
12006	1821	Shuttle Driver and Feed Lifting Cam....
2049	1828	" " " " " " Pin.

NO.	PLATE	NAME
14554	1818	Shuttle Race.....
141c	1852	" " Screw.....
11421	1814	Tension Bracket.....
190d	1824	" " Screw.....
8879	1827	" Friction Washer (cloth).....
11423	1826	" " " (steel).....
1560c	1854	" Regulating Thumb Nut.....
8905	1827	" " " " Washer..
411d	1855	" Screw Stud.....
11422	1827	" Spring.....
11044	1827	" Wheel.....
11420	—	Tension (wheel) complete, Nos. 411d, 1560c, 8905, 11044, 11422, 11423 and two 8879.....
11950	1829	Thread Eyelet.....
2102	1827	" Retaining Disc.....
1560c	1854	" " Regulating Thumb Nut
8905	1827	" " " " " "
		Washer.....
606d	1855	Thread Retaining Screw Stud.....
2103	1827	" " Spring.....
11503	—	Thread Retainer complete, Nos. 606d, 1560c, 2103, 8905 and two 2102.....
12050	1808	Thread Take-up Cam with two 434c....
8873	1828	" " " Pin.....
434c	1852	" " " Set Screw.....
11845	1807	" " Lever with 1995.....
567d	1851	" " " Hinge Screw.....
1995	1889	" " " Roller and Screw
		Stud with 1518E.....
1518E	1813	Thread Take-up Lever Roller and Screw
		Stud Nut.....
11052	1827	Thread Take-up Spring.....
11431	1827	" " " Regulator Plate
190d	1824	" " " " " "
		Adjusting Screw.....
14663	—	Throat Plate Body.....
14563	1841	" " Needle Hole Strip.....
401d	1851	" " " " " Screw....
14664	1839	Throat Plate complete for 14721, Nos. 14563, 14663 and two 401d.....
14519	1837	Throat Plate Holder.....
389F	1851	" " " Screw.....
202d	1852	" " Screw (long).....
228d	1852	" " " (short).....
14592	1809	Vibrating Presser Bar.....

NO.	PLATE	NAME
14593	1809	Vibrating Presser Bar Guide Bracket with 448c.....
14594	—	Vibrating Presser Bar Guide Bracket com- plete, Nos. 231c, 11472, 14593, 14595 and two 190d.....
14595	1809	Vibrating Presser Bar Guide Bracket
		Cap.....
190d	1824	Vibrating Presser Bar Guide Bracket
		Cap Screw.....
2117	1828	Vibrating Presser Bar Guide Bracket
		Pin.....
448c	1852	Vibrating Presser Bar Guide Bracket
		Set Screw.....
14596	1828	Vibrating Presser Bar Hinge Pin.....
460c	1852	" " " " " Set
		Screw.....
11471	1829	Vibrating Presser Bar Spring.....
11472	1829	" " " " Bracket
231c	1852	" " " " "
		Screw.....
56517	1887	Vibrating Presser Foot.....
898d	1852	" " " Screw.....
1547d	1854	" " " " Nut.....

## MACHINE NO. 11-20

FOR CLOTH. FOR QUILTING BED COVERS, BINDING, ETC., DROP FEED  
ACROSS THE ARM, HAS ALTERNATING PRESSERS AND  
FOOT LIFTER

This Machine is the same as No. 11-18 with the following exceptions:

NO.	PLATE	NAME
56509	1864	Cloth Plate.....
56510	1865	" " Bracket with two 345c.....
345c	1889	" " " Set Screw.....
14788	—	Cloth Plate with Bracket complete, Nos. 56509, 56510 and two 389F.....
389F	1851	Cloth Plate Screw.....
14720	1881	Feed Dog (double) in place of 14721....
14561	—	Throat Plate Body, in place of 14663....
14562	1841	Throat Plate complete for 14720, Nos. 14561, 14563 and two 401d, in place of 14664.....
12099	1836	Vibrating Presser Foot, in place of 11513.



**LIST OF PARTS COMPLETE  
FOR  
MACHINE NO. 11-21**

**FOR CLOTH OR LEATHER. DROP FEED UP THE ARM, MAKES STITCH  
FROM 1/8 TO 1/2 INCH LONG**

NO.	PLATE	NAME
*11951	—	Arm with 65D and 14710.....
8702	1828	" Dowel Pin.....
338E	1853	" Screw.....
14539	1800	" Shaft.....
11954	1809	" " Bushing.....
446c	1852	" " " Set Screw.....
6804	1804	" " Gear with 453c.....
2117	1828	" " " Pin.....
453c	1824	" " " Set Screw.....
144d	1852	" " Screw.....
14710	1862	" Side Cover.....
65d	1851	" " Hinge Screw.....
11957	1801	" " Wheel with two 446c.....
446c	1852	" " " Set Screw.....
6805	1804	" " " Shaft.....
6806	1804	" " " Gear with 453c....
2117	1828	" " " " " Pin.....
453c	1824	" " " " " Set Screw....
144d	1852	" " " " " Screw.....
8708	1828	" Spool Pin.....
11241	1863	" " " Washer (cloth)....per 100
11960	1801	Balance Wheel with two 354c.....
354c	1101	" " Set Screw.....
14540	1802	Crank Connecting Rod with 14541 and two 145E.....
*14541	—	Crank Connecting Rod Cap.....
145E	1852	" " " " " Screw.....
565c	1851	" " " " " Hinge Screw.....
1513E	1824	" " " " " Nut..
*14637	—	Cylinder, 3 1/8 in. diam.....
3032	1803	Feed Cam with 446c.....
446c	1852	" " Set Screw.....
3033	1813	" Connecting Link.....
375c	1813	" " " Hinge Screw.....
1518E	1813	" " " " " Nut..
14645	1848	" Dog.....
176c	1852	" " Screw.....

NO.	PLATE	NAME
12062	1802	Feed Forked Connection.....
375c	1813	" " " " Hinge Screw....
1518E	1813	" " " " " Nut
6132	1813	" " " " Universal Joint
212c	1813	" " " " " "
		Cap Screw.....
23c	1851	Feed Forked Connection Universal Joint Hinge Screw.....
11970	1813	Feed Regulator.....
58E	1813	" " " Hinge Screw.....
818D	1889	" " " Thumb Screw.....
14565	1803	" Rock Shaft.....
14665	1803	" " " Arm with 436c.....
2117	1828	" " " " Pin.....
436c	1852	" " " " Set Screw.....
304c	1852	" " " Screw Centre.....
1513E	1824	" " " " " Nut.....
14638	1801	" Rod.....
23c	1851	" " Hinge Screw.....
14507	1825	" " Raising Block.....
792c	1813	" " " " Screw.....
14501	1825	" " Spring.....
219D	1889	" " " Screw.....
11975	1805	Needle Bar.....
11976	1814	" " Connecting Link.....
375c	1813	" " " " " Hinge Screw
1518E	1813	" " " " " " "
		Nut.....
14547	1814	Needle Bar Connecting Stud with two 453c.....
453c	1824	Needle Bar Connecting Stud Set Screw..
258E	1854	" " Screw Bushing.....
19702	1829	" Clamp with 680D and 11385.....
11385	1825	" " Gib.....
680D	1855	" " Thumb Screw.....
11497	1857	Oil Cup.....
11917	1857	" " Cover.....
9084	1828	" " " Hinge Pin.....
2205	1825	" " " Latch Spring.....
207F	1852	" " " " " Screw.....
11919	1829	" " Thread Eyelet.....
8953	1826	" or Wax Stripper (felt).....
8482	1826	" " " " Washer (steel) for 11497.....
11918	1825	Oil or Wax Stripper Washer (steel) for 11917.....
207F	1852	Oil or Wax Stripper Washer Screw.....

NO.	PLATE	NAME
11921	1857	Oil Cup complete, Nos. 2205, 8482, 9084, 11497, 11917 to 11919, two 8953 and three 207F.....
134D	1852	Oil Cup Screw.....
12090	1804	Oscillating Rock Shaft with 11165.....
11164	1804	" " " Hinge Pin.....
435c	1852	" " " " " S e t Screw.....
11165	1826	Oscillating Rock Shaft Oil Pad.....
14639	1800	" Shaft.....
13324	—	" " Crank.....
13416	1824	Oscillating Shaft Crank complete, Nos. 453c, 1513E, 5868 and 13324.....
2117	1828	Oscillating Shaft Crank Pin.....
453c	1824	" " " Set Screw.....
9119	1824	" " " Slide Block.....
5868	1824	Oscillating Shaft Crank Slide Block complete, Nos. 190D, 1054c, 5968 and 9119.
190D	1824	Oscillating Shaft Crank Slide Block Cap Screw.....
5968	1824	Oscillating Shaft Crank Slide Block Cap Screw Washer.....
1054c	1824	Oscillating Shaft Crank Slide Block Screw Stud.....
1513E	1824	Oscillating Shaft Crank Slide Block Screw Stud Nut.....
11986	1805	Presser Bar.....
11988	1809	" " Guide Bracket with 175D and 446c.....
175D	1852	Presser Bar Guide Bracket Adjusting Screw.....
12066	1807	Presser Bar Guide Bracket Guide with 7393.....
164D	1852	Presser Bar Guide Bracket Guide Screw..
446c	1852	" " " " Set Screw.....
11990	1806	" " Lifter.....
685D	1851	" " Hinge Screw.....
7393	1828	" " Stop Pin.....
258E	1854	" " Screw Bushing.....
11991	1805	" " Spring.....
14572	1847	" Foot.....
176D	1852	" " Screw.....
252E	1854	Pressure Regulating Thumb Screw.....
14535	1821	Shuttle Bobbin.....
11999	1821	" Cylinder.....
12000	1819	" " Hinge Pin.....
12001	1821	" " Latch.....

NO.	PLATE	NAME
2027	1821	Shuttle Cylinder Latch Pin.....
11854	1821	" " " Spring.....
590E	1821	" " " " Screw....
12004	1821	" Frame.....
774c	1821	" Tension Regulating Screw.....
12005	1821	" " Spring.....
11997	1821	Shuttle (cylinder) 2½ in. diam., complete, Nos. 590E, 774c, 2027, 11854, 11999 to 12001, 12004, 12005 and 14535.....
14640	1823	Shuttle Driver and Feed Lifting Cam....
2117	1828	" " " " " " Pin.....
14554	1818	" Race.....
141c	1852	" " Screw.....
12008	1814	Tension Bracket.....
190D	1824	" " Screw.....
8879	1827	" Friction Washer (cloth).....
11423	1826	" " " (steel).....
1560c	1854	" Regulating Thumb Nut.....
8905	1827	" " " Washer..
411D	1855	" Screw Stud.....
11422	1827	" Spring.....
11044	1827	" Wheel.....
11420	—	Tension (wheel) complete, Nos. 411D, 1560c, 8905, 11044, 11422, 11423 and two 8879.....
14555	1829	Thread Eyelet (front of arm).....
11950	1829	" " (side of arm) for 11041....
2102	1827	" Retaining Disc.....
1560c	1854	" " Regulating Thumb Nut
8905	1827	" " " " Washer.....
686D	1855	Thread Retaining Screw Stud.....
2103	1827	" " Spring.....
11041	—	Thread Retainer complete, Nos. 686D, 1560c, 2103, 8905 and two 2102.....
12014	1808	Thread Take-up Cam with two 435c....
3012	1828	" " " Pin.....
435c	1852	" " " Set Screw.....
12016	1807	" " Lever with 1995.....
567D	1851	" " " Hinge Screw.....
1995	1889	" " " Roller and Screw Stud with 1518E.....
1518E	1813	Thread Take-up Lever Roller and Screw Stud Nut.....

NO.	PLATE	NAME
11052	1827	Thread Take-up Spring.....
11431	1827	" " " Regulator Plate..
190D	1824	" " " " " Ad-justing Screw.....
14641	1848	Throat Plate for 14645.....
14519	1837	" " Holder.....
389F	1851	" " " Screw.....
202D	1852	" " " Screw (long).....
228D	1852	" " " (short).....

## MACHINE NO. 11-22

FOR HAND POWER, DIFFERS FROM NO. 11-15 ONLY IN HAVING A  
HAND DRIVING MECHANISM ATTACHED TO THE S. D. A.  
HAND DRIVING ATTACHMENT PARTS

NO.	PLATE	NAME
14686	1893	Arm Shaft.....
14687	1893	Balance Wheel.....
14688	1893	" " Handle (wood).....
14689	1893	" " " Stud.....
1503E	1854	" " " " Nut.....
14690	1869	" " " " Washer..
14691	1869	" " " Washer with 2049.
390D	1889	" " " " Screw....
2049	1828	" " " Steady Pin.....
8873	1828	" " Pin.....
14692	1893	" " Stud with 7393.....
1503E	1854	" " " Nut.....
14693	1863	" " " Washer.....
144D	1852	" " Cap Screw.....
14694	1869	" " " " Washer.....
7393	1828	" " " " Steady Pin.....
8984	1812	Brake Block (wood).....
9D	1851	" " Screw.....
14695	1893	Friction Pulley.....
8714	1863	" " Pin.....
14696	1893	" " Shaft.....
11442	1858	" Washer (paper).....
401E	1851	" " Screw.....
14697	1893	" Wheel with two 354c.....
8873	1828	" " Pin.....
354c	1101	" " Set Screw.....

NO.	PLATE	NAME
56519	1893	Gear.....
56520	1893	" Cover for 56519.....
690D	1889	" " Screw.....
381D	1851	" Screw.....
14700	1893	Lever.....
14701	1893	" Bracket with 446c.....
8873	1828	" " Dowel Pin.....
779E	1889	" " Screw.....
14702	1868	" Hinge Pin.....
446c	1852	" " " Set Screw.....
8992	1812	" Spring.....
56521	1893	Pinion for 56519.....
14705	1863	" Pin.....
14672	1858	Treadle (wood).....
14673	1863	" Eyelet.....
342E	1855	" " Screw.....
9842	1829	" " " Washer.....
14674	1868	" Hinge.....
838D	1889	" " Screw.....
14706	—	Treadle complete, Nos. 342E, 9842, 14672 to 14674, 14708 and six wood screws 1¼ in. No. 10.....
27639	1893	Treadle Pitman Rod (lower).....
14707	1893	" " " (upper).....
9079	1893	" " " Clamp with 354c... ..
354c	1101	" " " " Screw.....
14708	1893	Treadle Pitman complete, Nos. 9079, 14707 and 27639.....
14709	—	Hand Driving Attachment complete, Nos. 9D, 144D, 390D, 8714, 8984, 8992, 11442, 14686 to 14697, 14700 to 14702, 14705, 14706, 56519 to 56521, two 8873, three 1503E, four each 401E, 690D and six 381D

**LIST OF PARTS COMPLETE**  
**FOR**  
**MACHINE NO. 11-23**

FOR STITCHING FINE BOOT LEGS OR OTHER TUBULAR ARTICLES IN  
LIGHT AND MEDIUM WEIGHT LEATHER; HAS CYLINDER  
2½ INCHES DIAMETER AT END, SHUTTLE NO. 6028,  
DROP FEED UP ARM, S. D. A.

NO.	PLATE	NAME
*14791	—	Arm with 65d and 14710.....
8702	1828	" Dowel Pin.....
338E	1853	" Screw.....
14792	1867	" Shaft.....
11954	1809	" " Bushing.....
446c	1852	" " " Set Screw.....
6804	1804	" " Gear with 453c.....
2117	1828	" " " Pin.....
453c	1824	" " " Set Screw.....
144b	1852	" " Screw.....
14710	1862	" Side Cover.....
65d	1851	" " " Hinge Screw.....
11957	1801	" " Wheel with two 446c.....
446c	1852	" " " Set Screw.....
6805	1804	" " " Shaft.....
6806	1804	" " " Gear with 453c.....
2117	1828	" " " " Pin.....
453c	1824	" " " " Set Screw.....
144b	1852	" " " " Screw.....
8708	1828	" Spool Pin.....
11241	1863	" " " Washer (cloth)....per 100
14644	1858	Balance Wheel with two 354c.....
354c	1101	" " " Set Screw.....
14789	1868	Crank Connecting Rod with 14790 and two 145E.....
*14790	—	Crank Connecting Rod Cap.....
145E	1852	" " " " Screw.....
372c	1851	" " " " Hinge Screw.....
1518E	1813	" " " " " Nut..
*14793	—	Cylinder, 2½ in. diam.....
3032	1803	Feed Cam with 446c.....
446c	1852	" " " Set Screw.....
3033	1813	" Connecting Link.....
375c	1813	" " " Hinge Screw.....
1518E	1813	" " " " " Nut..

NO.	PLATE	NAME
14711	1884	Feed Dog.....
176d	1852	" " Screw.....
12062	1802	" Forked Connection.....
375c	1813	" " " Hinge Screw....
1518E	1813	" " " " " Nut
6132	1813	" " " " Universal Joint
212c	1813	" " " " " "
		Cap Screw.....
23c	1851	Feed Forked Connection Universal Joint Hinge Screw.....
11970	1813	Feed Regulator.....
58E	1813	" " " Hinge Screw.....
818d	1889	" " " Thumb Screw.....
14794	1862	" Rock Shaft.....
14505	1803	" " " " Arm with 436c.....
2117	1828	" " " " " Pin.....
436c	1852	" " " " " Set Screw.....
304c	1852	" " " " " Screw Centre.....
1513E	1824	" " " " " Nut.....
14795	1864	" Rod.....
23c	1851	" " Hinge Screw.....
14507	1825	" " Raising Block.....
792c	1813	" " " " " Screw.....
14501	1825	" " Spring.....
219d	1889	" " " " " Screw.....
14796	1868	Needle Bar.....
11976	1814	" " Connecting Link.....
375c	1813	" " " " " Hinge Screw
1518E	1813	" " " " " " " "
		Nut.....
14547	1814	Needle Bar Connecting Stud with two 453c.....
453c	1824	Needle Bar Connecting Stud Set Screw..
258E	1854	" " " Screw Bushing.....
14797	1871	" " Thread Guard.....
233d	1852	" " " " " Screw.....
2167	1871	" Clamp with 196F.....
196F	1871	" " " " " Screw.....
11497	1857	Oil Cup.....
11917	1857	" " Cover.....
9084	1828	" " " Hinge Pin.....
2205	1825	" " " " Latch Spring.....
207F	1852	" " " " " " Screw.....
11919	1829	" " Thread Eyelet.....
8953	1826	" or Wax Stripper (felt).....
8482	1826	" " " " " Washer (steel) for 11497.....

NO.	PLATE	NAME
11918	1825	Oil or Wax Stripper Washer (steel) for 11917.....
207F	1852	Oil or Wax Stripper Washer Screw.....
11921	1857	Oil Cup complete, Nos. 2205, 8482, 9084, 11497, 11917 to 11919, two 8953 and three 207F.....
134d	1852	Oil Cup Screw.....
6022	1862	Oscillating Rock Shaft (steel) with 4784..
3052	1862	" " " Hinge Pin.....
1513E	1824	" " " " " Nut....
4784	1863	" " " Oil Pad.....
14798	1864	" Shaft.....
12453	1863	" " Back Bearing Oil Tube..
14799	1871	" " Crank with 1813 and two 457c.....
2049	1828	Oscillating Shaft Crank Pin.....
1813	1854	" " " Roller and Stud..
457c	1871	" " " Set Screw.....
11986	1805	Presser Bar.....
11988	1809	" " Guide Bracket with 175d and 446c.....
175d	1852	Presser Bar Guide Bracket Adjusting Screw.....
12066	1807	Presser Bar Guide Bracket Guide with 7393.....
164d	1852	Presser Bar Guide Bracket Guide Screw..
446c	1852	" " " " Set Screw....
11990	1806	" " Lifter.....
685d	1851	" " " Hinge Screw.....
7393	1828	" " " Stop Pin.....
258E	1854	" " Screw Bushing.....
11991	1805	" " Spring.....
14567	1844	" Foot (left of needle).....
176d	1852	" " Screw.....
252E	1854	Pressure Regulating Thumb Screw.....
1899	1840	Roller, 1¼ in., with 634d and 1528d.....
12031	1844	" Arm.....
440F	1852	" " Adjusting Screw.....
1547d	1854	" " " " Nut.....
12032	1844	" " Bracket.....
316F	1852	" " " Screw Centre.....
1547d	1854	" " " " " Nut....
2205	1825	" " Lock Spring.....
176d	1852	" " " " Screw.....
1549d	1854	" " " " " Nut.....
634d	1840	" Screw.....
1528d	1854	" " Nut.....

NO.	PLATE	NAME
12030	1844	Roller Presser, 1¼ in. roller, complete, Nos. 176d, 440F, 1549d, 1899, 2205, 12031, 12032, two 316F and three 1547d
176d	1852	Roller Presser Screw.....
2073	1873	Shuttle Bobbin.....
2211	1873	" " Retaining Spring.....
2212	1873	" " " " Rivet, per 100.....
*6058	—	Shuttle Body with 398E, 2082, 2084, 2211 and two 2212.....
*2075	—	Shuttle Cover.....
2076	1873	" " Hinge Pin.....
2078	1873	" Delivery Eye Thread Guard.....
2080	1873	" " " " " Rivet.
2082	1873	" Main Spring.....
398E	1873	" " " Screw.....
2084	1873	" " " Steady Pin.....
466H	1873	" Tension Regulating Screw.....
2086	1873	" " Spring.....
2090	1873	" " " Plate.....
112d	1873	" " " " Screw.....
6028	1873	Shuttle (high point) complete, Nos. 112d, 466H, 2073, 2075, 2076, 2078, 2080, 2086, 2090 and 6058.....
6147	1873	Shuttle Driver and Feed Lifting Cam....
2049	1828	" " " " " " Pin.
14800	1874	" Race.....
16688	—	" " Cover.....
16689	1874	" " " 16688 with 6472 and two 240d.....
6472	1874	Shuttle Race Cover Latch.....
240d	1874	" " " " Screw.....
104d	1874	" " " Screw.....
198d	1874	" " Screw.....
12008	1814	Tension Bracket.....
190d	1824	" " Screw.....
8879	1827	" Friction Washer (cloth).....
11423	1826	" " " (steel).....
1560c	1854	" Regulating Thumb Nut.....
8905	1827	" " " Washer..
411d	1855	" Screw Stud.....
11422	1827	" Spring.....
11044	1827	" Wheel.....
11420	—	Tension (wheel) complete, Nos. 411d, 1560c, 8905, 11044, 11422, 11423 and two 8879.....
14555	1829	Thread Eyelet (front of arm).....

NO.	PLATE	NAME
11950	1829	Thread Eyelet (side of arm) for 11041....
2102	1827	" Retaining Disc.....
1560c	1854	" " Regulating Thumb Nut
8905	1827	" " " " " "
		Washer.....
686d	1855	Thread Retaining Screw Stud.....
2103	1827	" " Spring.....
11041	—	Thread Retainer complete, Nos. 686d, 1560c, 2103, 8905 and two 2102.....
56508	1808	Thread Take-up Cam with two 435c....
3012	1828	" " " Pin.....
435c	1852	" " " Set Screw.....
12016	1807	" " Lever with 1995.....
567d	1851	" " " Hinge Screw.....
1995	1889	" " " Roller and Screw
		Stud with 1518E.....
1518E	1813	Thread Take-up Lever Roller and Screw
		Stud Nut.....
11894	1871	Thread Take-up Spring.....
11431	1827	" " " Regulator Plate
190d	1824	" " " " " "
		Adjusting Screw.....
14712	1884	Throat Plate for 14711.....
14713	1884	" " Holder.....
389F	1851	" " " Screw.....
219F	1889	" " " Screw.....

For Driving Attachment Parts, see Page 101

## LIST OF PARTS COMPLETE FOR MACHINE NO. 11-24

**FOR MAKING OR COVERING EYELETS OR GROMMET HOLES, WITH OR WITHOUT METAL RINGS, IN TARPULINS, SAILS, TENTS, MAIL BAGS, ETC. ALSO FURNISHED WITH PARTS FOR CHANGING TO FEED ACROSS THE ARM, FOR STRAIGHT STITCHING. DROP FEED. HAS CLEAR SPACE OF 30 INCHES AT RIGHT OF NEEDLE AND S. D. A. AS REGULARLY FURNISHED, HOLES  $\frac{1}{8}$ ,  $\frac{3}{16}$ ,  $\frac{1}{4}$  AND  $\frac{1}{2}$  INCH DIAMETER CAN BE MADE, BUT IF SO ORDERED THE MACHINE WILL BE FITTED TO MAKE HOLES 1 INCH TO  $4\frac{1}{2}$  INCHES DIAMETER, THE VARIATIONS IN SIZE BEING NOT LESS THAN  $\frac{1}{4}$  INCH**

NO.	PLATE	NAME
*14734	—	Arm with 65d and 14578.....
8702	1828	" Dowel Pin.....
496E	1853	" Screw.....
14735	1867	" Shaft.....
11354	1809	" " Bushing.....
437c	1852	" " " Set Screw.....
14606	1804	" " Gear with two 445c.....
3012	1828	" " " Pin.....
445c	1852	" " " Set Screw.....
14578	1857	" Side Cover.....
65d	1851	" " " Hinge Screw.....
14579	1801	" " Wheel with two 446c.....
446c	1852	" " " Set Screw.....
14607	1804	" " " Shaft.....
14608	1804	" " " " Gear with 453c...
2117	1828	" " " " Pin.....
453c	1824	" " " " Set Screw....
144d	1852	" " " " Screw.....
8708	1828	" Spool Pin.....
11241	1863	" " " Washer (cloth)...per 100
11438	1858	Balance Wheel with two 354c.....
8873	1828	" " Pin.....
354c	1101	" " Set Screw.....
14736	1865	Cloth Plate with 14760 and four 389F, for 1 in. to $4\frac{1}{2}$ in. grommet holes.....
14737	1865	Cloth Plate Bracket with two 345c.....
345c	1889	" " " Set Screw.....

NO.	PLATE	NAME
14738	—	Cloth Plate with Bracket complete, Nos. 14736, 14737 and two 389F
389F	1851	Cloth Plate Screw
11363	1802	Crank Connecting Rod with 11364 and two 145E
*11364	—	Crank Connecting Rod Cap
145E	1852	" " " " Screw
565c	1851	" " " " Hinge Screw
1513E	1824	" " " " Nut
*14609	—	Cylinder, 3 1/8 in. diam
11367	1803	Feed Cam with two 445c
445c	1852	" " Set Screw
11368	1803	" Connecting Link
565c	1851	" " " " Hinge Screw
1513E	1824	" " " " Nut
14739	1885	" Dog for 14506
14716	1881	" " (left of needle) for 14715
14722	1881	" " (right of needle) for 14715
14733	1866	" " Adjusting Piece
14715	1866	" " " " Carrier
792c	1813	" " " " Screw
176D	1852	" " Screw
14502	1802	" Forked Connection
565c	1851	" " " " Hinge Screw
1513E	1824	" " " " Nut
6132	1813	" " " " Universal Joint
212c	1813	" " " " " "
23c	1851	Cap Screw
23c	1851	Feed Forked Connection Universal Joint Hinge Screw
14583	1803	Feed Regulator
568E	1851	" " " " Hinge Screw
254D	1813	" " " " Thumb Screw
14525	1801	" Rock Shaft
14504	1803	" " " " for 300c
14505	1803	" " " " Arm with 436c
2117	1828	" " " " Pin
436c	1852	" " " " Set Screw
4448	1828	" " " " Back Bearing Oil Tube
14526	1803	" " " " Crank (forked) with 445c, for 14525
14522	1803	Feed Rock Shaft Crank with 445c, for 14524
14524	—	Feed Rock Shaft Crank complete for 14504, Nos. 164D, 6312, 14522 and 14523
3012	1828	Feed Rock Shaft Crank Pin for 14526

NO.	PLATE	NAME
2117	1828	Feed Rock Shaft Crank Pin for 14522
14523	1825	" " " " Roller
164D	1852	" " " " " " Cap Screw
6312	1826	" " " " " " " "
445c	1852	Washer
300c	1852	Feed Rock Shaft Crank Set Screw
1513E	1824	" " " " " " Screw Centre
14506	1801	" " " " " " Nut
23c	1851	" Rod
14501	1825	" " " " " " Hinge Screw
219D	1889	" " " " " " Spring
14740	1875	" " " " " " Screw
14741	1875	Grommet Hole Centre Guide (steel) for 1/2 in. ring, for 14774
14742	1875	Grommet Hole Centre Guide (steel) for 5/8 in. ring, for 14776
14743	1875	Grommet Hole Centre Guide (steel) for 3/4 in. ring, for 14777
14744	1875	Grommet Hole Centre Guide (steel) for 7/8 in. ring, for 14778
14745	1875	Grommet Hole Centre Guide (steel) for 1 in. ring, for 14779
14746	1875	Grommet Hole Centre Guide (cast iron) for 1 in. hole, for 14780
14746	1875	Grommet Hole Centre Guide (cast iron) for 1 1/4 in. hole, for 14781
		Nos. 14747 to 14759 for 14782
14747	1875	Grommet Hole Centre Guide (wood) for 1 1/2 in. hole
14748	1875	Grommet Hole Centre Guide (wood) for 1 3/4 in. hole
14749	1876	Grommet Hole Centre Guide (wood) for 2 in. hole
14750	1876	Grommet Hole Centre Guide (wood) for 2 1/4 in. hole
14751	1876	Grommet Hole Centre Guide (wood) for 2 1/2 in. hole
14752	1876	Grommet Hole Centre Guide (wood) for 2 3/4 in. hole
14753	1876	Grommet Hole Centre Guide (wood) for 3 in. hole
14754	1876	Grommet Hole Centre Guide (wood) for 3 1/4 in. hole
14755	1876	Grommet Hole Centre Guide (wood) for 3 1/2 in. hole
14756	1876	Grommet Hole Centre Guide (wood) for 3 3/4 in. hole

NO.	PLATE	NAME
14757	1877	Grommet Hole Centre Guide (wood) for 4 in. hole.....
14758	1877	Grommet Hole Centre Guide (wood) for 4¼ in. hole.....
14759	1877	Grommet Hole Centre Guide (wood) for 4½ in. hole.....
14026	1885	Grommet Hole Centre Guide Position Pin for 14773 and 14775.....
846D	1886	Grommet Hole Centre Guide Position Screw for 14782.....
175D	1852	Grommet Hole Centre Guide Screw for ½ to 1¼ in. centre guides.....
376D	1889	Grommet Hole Centre Guide Screw for 1½ in. to 4½ centre guides.....
14760	1868	Grommet Hole Centre Guide Screw Block for 14736.....
389F	1851	Grommet Hole Centre Guide Screw Block Screw.....
11538	1870	Needle Bar.....
11539	1866	" " Connecting Link.....
566C	1851	" " " " Hinge Screw.....
1513E	1824	" " " " " " Nut.....
11383	1814	Needle Bar Connecting Stud with two 445c.....
445c	1852	Needle Bar Connecting Stud Set Screw..
14728	1870	" " Frame with 190D and 14732..
14610	1811	" " " " Cam.....
14611	—	Needle Bar Frame Cam complete, Nos. 14610, 14612 and two 159D.....
14612	1811	Needle Bar Frame Cam Bevel Gear.....
567D	1851	" " " " " " Screw.....
14613	1811	" " " " " " Cover.....
202D	1852	" " " " " " Screw.....
159D	1852	" " " " " " Screw.....
14614	1811	" " " " Driving Bevel Pinion with two 445c.....
445c	1852	Needle Bar Frame Driving Bevel Pinion Set Screw.....
14615	1828	Needle Bar Frame Hinge Pin.....
435c	1852	" " " " " " Set Screw..
14729	1870	" " " " Pitman.....
1371c	1889	" " " " " Hinge Screw..
14730	1871	" " " " " " S t u d
14731	1871	" " " " " " Collar with 448c.....

NO.	PLATE	NAME
448c	1871	Needle Bar Frame Pitman Hinge Stud Collar Set Screw.....
14534	1811	Needle Bar Frame Regulator with 1813 and two 212D.....
1086E	1854	Needle Bar Frame Regulator Adjusting Screw.....
14616	1825	Needle Bar Frame Regulator Adjusting Screw Sleeve.....
212D	1813	Needle Bar Frame Regulator Adjusting Screw Stop Screw.....
1639D	1854	Needle Bar Frame Regulator Adjusting Screw Thumb Nut.....
1813	1854	Needle Bar Frame Regulator Roller and Stud.....
164D	1852	Needle Bar Frame Regulator Screw.....
41544	1826	" " " " " Washer
14732	1871	" " " " Thread Guard.....
190D	1824	" " " " " Screw..
56522	1869	" " " " Washer (steel).....
19702	1829	" " Clamp with 680D and 11385.....
11385	1825	" " " " Gib.....
680D	1855	" " " " Thumb Screw.....
11497	1857	Oil Cup.....
11917	1857	" " " " Cover.....
9084	1828	" " " " Hinge Pin.....
2205	1825	" " " " Latch Spring.....
207F	1852	" " " " " " Screw.....
11919	1829	" " " " Thread Eyelet.....
8953	1826	" " or Wax Stripper (felt).....
8482	1826	" " " " Washer (steel) for 11497.....
11918	1825	Oil or Wax Stripper Washer (steel) for 11917.....
207F	1852	Oil or Wax Stripper Washer Screw.....
11921	1857	Oil Cup complete, Nos. 2205, 8482, 9084, 11497, 11917 to 11919, two 8953 and three 207F.....
134D	1852	Oil Cup Screw.....
56534	1804	Oscillating Rock Shaft (steel).....
56535	—	Oscillating Rock Shaft complete, Nos. 622c, 11165, 11398, 56534 and two 1508E.....
11398	1804	Oscillating Rock Shaft Hinge Pin.....
1508E	1101	" " " " " " Nut....
622c	1854	" " " " " " Screw
		Bearing.....



NO.	PLATE	NAME
1508E	1101	Oscillating Rock Shaft Hinge Pin Screw Bearing Nut.....
11165	1826	Oscillating Rock Shaft Oil Pad.....
56523	1867	" Shaft with 2049 and 56524....
11930	—	" " Crank.....
19697	1871	Oscillating Shaft Crank complete, Nos. 453c, 1513E, 5868 and 11930.....
2117	1828	Oscillating Shaft Crank Pin.....
453c	1871	" " " Set Screw.....
9119	1824	" " " Slide Block.....
5868	1824	Oscillating Shaft Crank Slide Block complete, Nos. 190D, 1054c, 5968 and 9119.
190D	1824	Oscillating Shaft Crank Slide Block Cap Screw.....
5968	1824	Oscillating Shaft Crank Slide Block Cap Screw Washer.....
1054c	1824	Oscillating Shaft Crank Slide Block Screw Stud.....
1513E	1824	Oscillating Shaft Crank Slide Block Screw Stud Nut.....
*56524	—	Oscillating Shaft Sleeve.....
2049	1828	" " " Pin.....
14603	1805	Presser Bar.....
14532	1809	" " Guide Bracket with 145D and 445c.....
145D	1852	Presser Bar Guide Bracket Adjusting Screw.....
14617	1807	Presser Bar Guide Bracket Guide with 2022.....
381D	1851	Presser Bar Guide Bracket Guide Screw..
445c	1852	" " " " Set Screw.....
14761	1870	" " " Lifter.....
8760	1826	" " " Friction Washer.....
50063D	1889	" " " Hinge Screw.....
1513E	1824	" " " " Nut.....
194D	1889	" " " Screw Stud.....
2022	1828	" " " Stop Pin.....
11991	1805	" " " Spring.....
11411	1825	" " " Collar with 453c.....
453c	1824	" " " Set Screw.....
14559	1838	" Foot (left of needle) for 14716....
14558	1838	" " (right of needle) for 14722..
14762	1887	" " for 14739, for grommet holes
14763	1887	" " " " rings.....
176D	1852	" " Screw.....
X 14535	1821	Shuttle Bobbin.....
14764	1872	" Cylinder.....

NO.	PLATE	NAME
12000	1819	Shuttle Cylinder Hinge Pin.....
14529	1822	" " Latch.....
2027	1821	" " " Pin.....
11854	1821	" " " Spring.....
590E	1821	" " " Screw....
14530	1822	" Frame.....
773c	1820	" Tension Regulating Screw.....
12005	1821	" " Spring.....
14765	1872	Shuttle (cylinder) 2½ in. diam., complete, Nos. 590E, 773c, 2027, 11854, 12000, 12005, 14529, 14530, 14535 and 14764.
56525	1872	Shuttle Driver and Feed Lifting Cam....
2049	1828	" " " " " Pin.
14618	1818	" Race.....
141c	1852	" " Screw.....
14766	1871	Tension (lower) Bracket.....
190D	1824	" " " Screw.....
8879	1827	" " Friction Washer (cloth)..
11043	1826	" " " " (steel)...
1560c	1854	" " Regulating Thumb Nut
8905	1827	" " " " "
		Washer.....
632D	1855	Tension (lower) Screw Stud.....
8791	1827	" " Spring.....
11044	1827	" " Wheel.....
2102	1827	" (upper) Disc.....
1560c	1854	" " Regulating Thumb Nut
8905	1827	" " " " "
		Washer.....
14767	1871	Tension (upper) Releaser.....
14768	1862	" " " Body.....
14769	1871	" " " " B l o c k (lower).....
401D	1851	Tension (upper) Releaser Body Block (lower) Screw.....
14770	1871	Tension (upper) Releaser Body Block (upper).....
401D	1851	Tension (upper) Releaser Body Block (upper) Screw.....
756D	1871	Tension (upper) Releaser Screw.....
14771	—	Tension (upper) Releaser complete, Nos. 14767 to 14770, two 756D and four 401D
50064D	1889	Tension (upper) Screw Stud.....
2103	1827	" " Spring.....
11950	1829	" " Thread Eyelet.....
14621	1808	Thread Take-up Cam with two 434c....
8873	1828	" " " Pin.....

NO.	PLATE	NAME
434c	1852	Thread Take-up Cam Set Screw.....
19754	1868	" " Lever with 1948 and 1995.....
567D	1851	Thread Take-up Lever Hinge Screw.....
1995	1889	" " " Roller and Screw Stud with 1518E.....
1518E	1813	Thread Take-up Lever Roller and Screw Stud Nut.....
1948	1889	Thread Take-up Lever Thread Guiding Roller.....
8798	1827	Thread Take-up Spring.....
14624	1827	" " " Regulator Plate
190D	1824	" " " " " " Adjusting Screw.....
14772	1869	Thread Take-up Spring Staple.....
690D	1889	" " " " " Screw.....
41544	1826	" " " " " Washer
14520	1838	Throat Plate for 14716.....
14521	1838	" " " 14722.....
14773	1885	" " with 14026, for 14739 for 14774.....
14774	—	Throat Plate 14773 with 175D and 14740, for 1/2 in. ring.....
14775	1885	Throat Plate with 14026, for 14739 for 14776 to 14781.....
14776	—	Throat Plate 14775 with 175D and 14741, for 5/8 in. ring.....
14777	—	Throat Plate 14775 with 175D and 14742, for 3/4 in. ring.....
14778	—	Throat Plate 14775 with 175D and 14743, for 7/8 in. ring.....
14779	—	Throat Plate 14775 with 175D and 14744, for 1 in. ring.....
14780	—	Throat Plate 14775 with 175D and 14745, for 1 in. hole.....
14781	—	Throat Plate 14775 with 175D and 14746, for 1 1/4 in. hole.....
14782	1886	Throat Plate with 846D, for 14739 for 14747 to 14759, for 1 1/2 in. to 4 1/2 in. holes.....
14783	1888	Throat Plate Holder.....
389F	1851	" " " Screw.....
202D	1852	" " " Screw (long).....
228D	1852	" " " (short).....

For Driving Attachment Parts, see Page 100

## MACHINE NO. 11-25

HAS BALANCE WHEEL NO. 11356 FOR UNDER DRIVER, OTHERWISE SAME AS NO. 11-24

NO.	PLATE	NAME
14786	1867	Arm Shaft, in place of 14735.....
11356	1801	Balance Wheel with two 354c, in place of 11438.....
8937	1863	Balance Wheel Pin, in place of 8873.....

## MACHINE NO. 11-26

HAS S. D. A. OTHERWISE THE SAME AS NO. 11-16 MACHINE

NO.	PLATE	NAME
14735	1867	Arm Shaft, in place of 14786.....
11438	1858	Balance Wheel with two 354c, in place of 11356.....
8873	1828	Balance Wheel Pin, in place of 8937..... For Driving Attachment Parts, see Page 100

## ACCESSORIES

NO.	PLATE	NAME
490E	1853	Bolt with 1600E, to secure machine to power table.....
1600E	1854	Bolt Nut.....
9281	1826	" " Washer.....
36563	1890	Oiler (copper plated) with 36564.....
36564	1890	" Spout, 5 in. long.....
11831	1856	Screw Driver (large).....
26026	1856	" " (medium).....
26485	1890	" " (small).....
4822	1890	Wrench for 1518, 1528 and 1547.....
8908	1856	" " 1520.....
8909	1856	" " 1513 and 1518.....
8910	1856	" " 338, 1508 and 1600.....
8911	1890	" " 496 and 1503.....
25200	1890	" " 354.....

## BOBBIN WINDERS

### BOBBIN WINDER (Hand)

#### FOR MACHINE BED

NO.	PLATE	NAME
11756	—	Belt with 25028.....
25028	1829	" Hook.....
11758	1800	Frame.....
11759	1812	Pulley.....
11760	1800	" Driving Wheel.....
8380	1812	" " " Handle.....
11762	1828	" " " " Stud.....
8382	1826	" " " " " Washer
11761	—	Pulley Driving Wheel Handle complete, Nos. 8380, 8382 and 11762.....
11763	1828	Pulley Driving Wheel Stud.....
2269	1828	" " " " Pin.....
11764	1826	" " " " " Washer.....
11765	1805	Spindle.....
11754	1800	Bobbin Winder complete, Nos. 2269, 11756, 11758 to 11761 and 11763 to 11765.....
135D	1852	Bobbin Winder Screw.....

### BOBBIN WINDER (Hand)

#### FOR WOOD TABLE

NO.	PLATE	NAME
11768	—	Belt with 25028.....
25028	1829	" Hook.....
11769	1800	Frame.....
11770	1812	Pulley.....
11760	1800	" Driving Wheel.....
8380	1812	" " " Handle.....
11762	1828	" " " " Stud.....
8382	1826	" " " " " Washer
11761	—	Pulley Driving Wheel Handle complete, Nos. 8380, 8382 and 11762.....
11763	1828	Pulley Driving Wheel Stud.....
2269	1828	" " " " Pin.....
11764	1826	" " " " " Washer.....
11771	1805	Spindle.....
11766	1800	Bobbin Winder complete, Nos. 528E, 2269, 11760, 11761, 11763, 11764 and 11768 to 11771.....
528E	1855	Bobbin Winder Clamping Screw.....

## BOBBIN WINDER (Automatic)

### FOR 14535

NO.	PLATE	NAME
15072	1891	Bobbin Position Pin..... per 100
14717	1891	Spindle with 15072.....
9067	1892	" Frame.....
9068	1891	" " Spring.....
7958	1891	" " " Pin.....
2448	1892	" Pulley.....
9062	1892	Stand with 178c.....
9063	1891	" Shaft.....
9064	1891	" " Collar.....
9065	1892	" " Pulley.....
178c	1891	" " Set Screw.....
14718	1892	Stop Latch.....
9070	1892	" " Bracket with 178c.....
178c	1891	" " " Set Screw.....
24d	1891	" " Hinge Screw.....
1541D	1891	Tension Regulating Thumb Nut.....
470D	1891	" Spool Pin with fixed cone.....
8018	1891	" " " Adjustable Cone.....
8019	1891	" " " Spring.....
9071	—	Tension Spool Pin complete, Nos. 470D, 1541D, 8018 and 8019.....
9074	1891	Tension Thread Guide Pin.....
14719	1892	Bobbin Winder complete, Nos. 24D, 2448, 7958, 9062 to 9065, 9067, 9068, 9070, 9071, 9074, 14717, 14718 and two wood screws 1 in. No. 7.....

## COLUMN STAND

### FOR MACHINES NOS. 11-15, 11-22 AND 11-24

NO.	PLATE	NAME
14685	—	Column Stand with three 838D and four each 494E and 779E.....
494E	1889	Column Stand Screw, to secure stand to floor.....
779E	1889	Column Stand Screw, to secure machine to stand.....
838D	1889	Treadle Hinge Screw.....

## DRIVING ATTACHMENT

FOR MACHINES NOS. 11-15, 11-22, 11-24 AND 11-26

NO.	PLATE	NAME
11438	1858	Balance Wheel with two 354c.....
8873	1828	“ “ Pin.....
354c	1101	“ “ Set Screw.....
8984	1812	Brake Block (wood).....
9D	1851	“ “ Screw.....
11440	1858	Friction Pulley with 11441.....
11441	1809	“ “ Centre Plug.....
11442	1858	“ Washer (paper).....
401E	1851	“ “ Screw.....
14784	1867	Lever.....
14598	1858	“ Bracket.....
2117	1828	“ “ Dowel Pin.....
123E	1852	“ “ Screw.....
135D	1852	“ Screw.....
8991	1812	“ “ Washer.....
8992	1812	“ Spring.....
14785	1863	“ “ Hook.....
1520E	1889	“ “ “ Nut.....
6055	1863	“ “ “ Washer.....
166D	1855	“ “ Screw.....
11864	1858	Shaft Driving Pulley, 10 in. diam., 1¼ in. face, 1⅜ in. bore (sectional) with two 597c.....
597c	1855	Shaft Driving Pulley Clamping Screw.....
14672	1858	Treadle (wood).....
14673	1863	“ Eyelet.....
342E	1855	“ “ Screw.....
9842	1829	“ “ “ Washer.....
14674	1868	“ Hinge.....
14706	—	Treadle complete, Nos. 342E, 9842, 14672 to 14674, 14708 and six wood screws 1¼ in. No. 10.....
27639	1893	Treadle Pitman Rod (lower).....
14707	1893	“ “ “ (upper).....
9079	1893	“ “ “ Clamp with 354c.....
354c	1101	“ “ “ Screw.....
14708	1893	Treadle Pitman complete, Nos. 9079, 14707 and 27639.....
14599	—	Singer Driving Attachment complete, Nos. 9D, 135D, 166D, 1520E, 6055, 8873, 8984, 8991, 8992, 11438, 11440, 11442, 11864, 14598, 14706, 14784, 14785, two 123E and four 401E.....

## DRIVING ATTACHMENT

FOR MACHINES NOS. 11-8 AND 11-23

NO.	PLATE	NAME
14644	1858	Balance Wheel with two 354c.....
354c	1101	“ “ Set Screw.....
56501	1863	Brake Block (wood).....
122D	1852	“ “ Screw.....
14651	1858	Friction Pulley.....
14652	1815	“ “ Guide.....
164D	1852	“ “ “ Screw.....
14653	1815	“ “ Stud.....
1503E	1854	“ “ “ Nut.....
25114	1812	“ “ “ “ Washer.....
14654	1858	“ “ Washer (paper).....
401E	1851	“ “ “ Screw.....
14655	1858	Lever.....
14656	1858	“ Bracket.....
3012	1828	“ “ Dowel Pin.....
123E	1852	“ “ Screw.....
135D	1852	“ Screw.....
25011	1812	“ “ Washer.....
8992	1812	“ Spring.....
11864	1858	Shaft Driving Pulley, 10 in. diam., 1¼ in. face, 1⅜ in. bore (sectional) with two 597c.....
597c	1855	Shaft Driving Pulley Clamping Screw.....
27636	363	Treadle.....
9082	1101	“ Bearing Cotter Pin.....
27637	362	“ Pitman Rod (lower).....
27638	1101	“ “ “ “ Spring.....
27639	362	“ “ “ “ (upper).....
9079	362	“ “ “ “ Clamp with 354c.....
354c	1101	“ “ “ “ Screw.....
27640	362	Treadle Pitman complete, Nos. 2762, 9079 and 27637 to 27639.....
2878	363	Treadle Stand.....
2762	1815	“ Stop Collar with 362F.....
362F	1853	“ “ “ Set Screw.....
27642	—	Treadle complete, Nos. 2878, 9082, 27636 and four wood screws 1 in. No. 16.....
27643	—	Treadle and Pitman complete, Nos. 27640 and 27642.....
14714	—	Driving Attachment complete, Nos. 122D, 135D, 164D, 1503E, 8992, 11864, 14644, 14651 to 14656, 25011, 27643, 56501, two 123E and four 401E.....

## FOOT LIFTER PARTS

FOR MACHINES NOS. 11-6, 11-18 AND 11-20

NO.	PLATE	NAME
13351	—	Chain, 46 in. to 55 in. long.....
NOTE: When ordering No. 13351 give length required.		
4879	1812	Chain Connecting Link.....
14600	1801	Lifting Lever.....
568D	1851	" " Hinge Screw.....
19510	1825	" " Spring.....
86D	1851	" " " Screw.....
4881	1857	Treadle.....
4882	1812	" Shaft.....
4883	1812	" Spring.....
4884	1857	" Stand.....
4885	1857	Treadle complete, Nos. 4879, 4881 to 4884 and two wood screws 1 in. No. 16.....
14601	1810	Vibrating Presser Bar Hinge Bracket 145F.....
145F	1852	Vibrating Presser Bar Hinge Bracket Adjusting Screw.....
58D	1813	Vibrating Presser Bar Hinge Bracket Lifting Screw.....
14602	—	Foot Lifter complete, Nos. 58D, 568D, 4885, 13351, 14600, 14601, 19510 and two 86D

## STAND PARTS

NO.	PLATE	NAME
14659	1800	Arm Shaft.....
14660	1861	Balance Wheel with two 354c.....
354c	1101	" " Set Screw.....
25004	1861	Band Wheel (two speed) 12 in. and 14 in. diam., with 9296.....
9296	1805	Band Wheel Pitman Stud.....
25089	1828	" " " " Pin.....
11743	1826	" " " " Washer.....
559E	1853	" " Stud.....
1503E	1854	" " Nut.....
150D	1852	" " Screw.....
25011	1812	" " " " Washer.....
25114	1812	" " " " Washer.....

NO.	PLATE	NAME
25012	—	Belt, size $\frac{3}{8}$ in., length 80 $\frac{1}{2}$ in., with 25030
25030	1829	" Hook.....
781E	1853	Bolt with 1600E, to secure machine to stand.....
1600E	1854	Bolt Nut.....
9281	1826	" " Washer.....
25034	1860	Brace with two each 296c and 1507E....
534E	1853	" Bolt with 1510E.....
1510E	1854	" " Nut.....
25061	1860	Leg (left).....
25062	1860	" (right).....
25120	1861	Table Top (iron).....
507E	1853	" " Bolt with 1515E.....
1515E	1854	" " " Nut.....
25080	1861	Treadle with two each 164D, 25085 and 41544.....
25073	1861	Treadle Pitman (wood).....
296c	1852	" Screw Centre.....
1507E	1854	" " " Nut.....
25085	—	" Strap (leather).....
164D	1852	" " Screw.....
41544	1826	" " " Washer.....
25086	1890	Wrench for 1507, 1510 and 1515.....
25208	—	Stand (iron work) rocking treadle, com- plete, Nos. 150D, 559E, 1503E, 25004, 25011, 25034, 25061, 25062, 25073, 25080, 25086, 25114, 25120, two each 11743, 25089 and four each 507E and 534E.....

## TABLE BELT GUIDE

NO.	PLATE	NAME
14229	1859	Bracket with 448c.....
14230	1859	Pulley.....
14231	1805	" Shaft with 858c.....
858c	1852	" " Plug Screw.....
448c	1852	" " Set Screw.....
14232	1859	Table Belt Guide complete, Nos. 14229 to 14231 and four R. H. B. wood screws 1 $\frac{1}{4}$ in. No. 10.....

## TRANSVERSE UNDER DRIVER

NO.	PLATE	NAME
27593	1812	Brake (fibre).....
27594	1859	" Bracket with 27593 and two 327E.
927c	1852	" " Adjusting Screw.....
1513E	1824	" " " " Nut.....
307c	1852	" " Screw Centre.....
1513E	1824	" " " " Nut.....
327E	1851	" Screw.....
27595	1859	Cone Pulley (grooved) two speed, 4½ in. and 5½ in. diam., with 27473.....
27473	1101	Cone Pulley Centre Bearing.....
27596	1859	Dress Guard (left hand).....
354c	1101	" " Screw.....
2018	1101	" " Washer.....
27597	1859	Driving Pulley (grooved) 6¼ in. diam., with 433c, 27598 and two 7958.....
27598	—	Driving Pulley Friction Ring (leather)...
7958	1828	" " " " Stop Pin....
27631	1101	" " Hollow Stud with 27600..
27600	1101	" " " " Position Stud.....
356c	1855	Driving Pulley Hollow Stud Set Screw...
27632	—	" " " " Wick.....
27633	—	" " " " Wire with 27632.....
433c	1101	Driving Pulley Screw Centre Bearing
7958	1828	" " " " " " Dowel Pin.....
27601	1859	Frame.....
27668	1859	Idler Pulley.....
27603	1859	" " Bracket and Oil Cup.....
927c	1852	" " " " " " Screw (lower).....
134E	1852	Idler Pulley Bracket and Oil Cup Screw (upper).....
1513E	1824	Idler Pulley Bracket and Oil Cup Screw (upper) Nut.....
27669	1805	Idler Pulley Hollow Stud.....
615c	1854	" " " " Cap Screw....
356c	1855	" " " " Set Screw.....
27632	—	" " " " Wick.....
27678	—	" " " " Wire with 27632.....

NO.	PLATE	NAME
614c	1854	Idler Pulley Cap Screw.....
27605	1859	Lever.....
27606	1805	" Centre Plug (wood).....
427E	1101	" " " Adjusting Screw.....
1508E	1101	" " " " " Nut..
307c	1852	" Screw Centre.....
1513E	1824	" " " Nut.....
27607	1812	" Spring.....
2763	1857	Rock Shaft.....
27683	1857	" " Arm with two 356c.....
356c	1855	" " " Set Screw.....
27684	1812	" " Connecting Link.....
2764	1857	" " Hanger with two wood screws 1 in. No. 10.....
27685	1857	Rock Shaft complete, Nos. 2763, 27684 and two each 2764 and 27683.....
27070	363	Shaft Driving Pulley (sectional, grooved) 10 in. diam., 1⅜ in. bore, with two 597c
597c	1855	Shaft Driving Pulley Clamping Screw...
27636	363	Treadle.....
9082	1101	" Bearing Cotter Pin.....
27637	362	" Pitman Rod (lower).....
27638	1101	" " " " Spring.....
27639	362	" " " (upper).....
9079	362	" " " Clamp with 354c...
354c	1101	" " " " Screw.....
27640	362	Treadle Pitman complete, Nos. 2762, 9079 and 27637 to 27639.....
2878	363	Treadle Stand.....
2762	1815	" Stop Collar with 362F.....
362F	1853	" " " Set Screw.....
27642	—	Treadle complete, Nos. 2878, 9082, 27636 and four wood screws 1 in. No. 16.....
27643	—	Treadle and Pitman complete, Nos. 27640 and 27642.....
27608	—	Transmitter complete for 27609, Nos. 134E, 354c, 427E, 614c, 615c, 1508E, 2018, 27594 to 27597, 27601, 27603, 27605 to 27607, 27631, 27633, 27668, 27669, 27678, two each 356c, 927c, three wood screws 1½ in. No. 16, four 307c and six 1513E.....
27609	—	Transverse Under Driver, lever pressure, two speed, complete, Nos. 27070, 27608, 27643 and 27685.....

## UNDER DRIVER

### LEVER PRESSURE, THREE SPEED, RIGHT HAND (OIL CONTROLLING PULLEY) FOR 11-25 MACHINE

NO.	PLATE	NAME
27508	362	Belt Guard.....
649E	1889	" " Screw.....
27509	362	Cone Pulley (grooved) three speed, 2½ in., 3¾ in. and 5¼ in. diam., with 27473...
27473	1101	Cone Pulley Centre Bearing.....
27474	363	Dress Guard (right hand).....
138E	1101	" " Screw.....
27630	362	Driving Pulley (grooved) 6 in. diam., with 433c, 27598 and two 7958.....
27598	—	Driving Pulley Friction Ring (leather)...
7958	1828	" " " " Stop Pin....
27631	1101	" " Hollow Stud with 27600..
27600	1101	" " " " Position Stud.....
356c	1855	Driving Pulley Hollow Stud Set Screw...
27632	—	" " " " Wick.....
27633	—	" " " " " Wire with 27632.....
433c	1101	Driving Pulley Screw Centre Bearing
7958	1828	" " " " " " Dowel Pin.....
27634	362	Frame.....
41338	362	Lever.....
27483	1101	" Brake Spring.....
27497	1101	" " Strip (leather).....
12178	1101	" Centre Plug (wood).....
427E	1101	" " " Adjusting Screw.....
1508E	1101	" " " " " Nut..
27485	1101	" Hinge Pin.....
27635	362	Oil Cup.....
127E	1855	" " Screw.....
27070	363	Shaft Driving Pulley (sectional, grooved) 10 in. diam., 1⅜ in. bore, with two 597c
597c	1855	Shaft Driving Pulley Clamping Screw....
27636	363	Treadle.....
9082	1101	" Bearing Cotter Pin.....
27637	362	" Pitman Rod (lower).....
27638	1101	" " " " Spring.....

NO.	PLATE	NAME
27639	362	Treadle Pitman Rod (upper).....
9079	362	" " " Clamp with 354c...
354c	1101	" " " " Screw.....
27640	362	Treadle Pitman complete, Nos. 2762, 9079 and 27637 to 27639.....
2878	363	Treadle Stand.....
2762	1815	" Stop Collar with 362F.....
362F	1853	" " " Set Screw.....
27642	—	Treadle complete, Nos. 2878, 9082, 27636 and four wood screws 1 in. No. 16.....
27643	—	Treadle and Pitman complete, Nos. 27640 and 27642.....
27644	—	Transmitter complete for 27645, Nos. 138E, 356c, 427E, 649E, 1508E, 12178, 27474, 27483, 27485, 27497, 27508, 27509, 27630, 27631, 27633 and 27635, 41338, two 127E and four wood screws 1½ in. No. 16.....
27645	—	Under Driver, lever pressure, three speed, right hand (oil controlling pulley) com- plete, Nos. 27070, 27643 and 27644....

## OBSOLETE PARTS

NO.	PLATE	NAME
*14575	—	Arm for 11-15 and 11-22 Machines.....
*14604	—	" " 11-16 Machine.....
14537	1800	" Shaft for 11-15, 11-16 and 11-22 Machines.....
11953	1800	Arm Shaft for 11-1 Machine.....
14605	1800	" " " 11-16 Machine.....
14576	1804	" " Gear with two 453c, for 11-15, 11-16 and 11-22 Machines.....
14577	1857	Arm Side Cover (front) for 11-15 and 11-22 Machines.....
330D	1851	Arm Side Cover (front) Screw for 11-15 and 11-22 Machines.....
*11955	—	Arm Side Plate for 11-1 to 11-9, 11-11 to 11-14 and 11-17 to 11-21 Machines....
164D	1852	Arm Side Plate Screw for 11-1 to 11-9, 11-11 to 11-14 and 11-17 to 11-21 Machines.....
11958	1804	Arm Side Wheel Shaft for 11-1, 11-3, 11-4 and 11-6 Machines.....
14580	1804	Arm Side Wheel Shaft for 11-15, 11-16 and 11-22 Machines.....

NO.	PLATE	NAME
6806	1804	Arm, Side Wheel Shaft Gear with 453c, for 11-15, 11-16 and 11-22 Machines.....
8873	1828	Balance Wheel Pin for 11356 for 11-16 Machine.....
11963	1802	Crank Connecting Rod with 11964 and two 158E, for 11-1 Machine.....
12038	1802	Crank Connecting Rod with 11964 and two 158E, for 11-3, 11-4 and 11-6 Machines.....
*11964	---	Crank Connecting Rod Cap for 11963 and 12038.....
158E	1852	Crank Connecting Rod Cap Screw for 11963 and 12038.....
372c	1851	Crank Connecting Rod Hinge Screw for 11-1, 11-3, 11-4 and 11-6 Machines....
1518E	1813	Crank Connecting Rod Hinge Screw Nut for 11-1, 11-3, 11-4 and 11-6 Machines.
*11961	---	Cylinder, 3½ in. diam., for 12007, for 11-1 Machine.....
*14658	---	Cylinder, 3½ in. diam., for 12098, for 11-3, 11-4 and 11-6 Machines.....
11443	1858	Driving Attachment Lever for 14599....
10855	1815	" " " Brake Roll (wood) for 14714.....
14675	---	Driving Attachment Treadle complete for 14599, Nos. 342E, 9842, 14672 to 14674, 14676 and six wood screws 1¼ in. No. 10
2877	1800	Driving Attachment Treadle Pitman Rod (upper) for 14676.....
14676	1800	Driving Attachment Treadle Pitman complete for 14675, Nos. 2877, 9079 and 27639.....
11965	1812	Feed Bell Crank Slide for 11-1 and 11-4 Machines.....
14512	1839	Feed Dog for 11967, for 11-18 and 11-19 Machines.....
14666	1850	Feed Dog, for closing, for 11967, for 11-15 and 11-22 Machines.....
12039	1841	Feed Dog (double) for 11967, for 11-12 and 11-20 Machines.....
12072	1838	Feed Dog (left of needle) for 11967, for 11-12, 11-15 to 11-17 and 11-22 Machines.....
14544	1842	Feed Dog (left of needle) for 11967, for 11-11 Machine.....
14569	1845	Feed Dog (left of needle) for 14566, for 11-17 Machine.....

NO.	PLATE	NAME
14582	1843	Feed Dog (left of needle) for 11967, for 11-15 and 11-22 Machines.....
14669	1850	Feed Dog (left of needle) for 11967, for 11-15 and 11-22 Machines.....
14716	1881	Feed Dog (left of needle) for 14715, for 11-15 and 11-22 Machines.....
14543	1840	Feed Dog (right of needle) for 11967, for 11-11 Machine.....
14536	1838	Feed Dog (right of needle) for 11967, for 11-12 and 11-16 Machines.....
14682	1841	Feed Dog (right of needle) for panel work, for 11967, for 11-15 and 11-22 Machines
12028	1825	Feed Dog Adjusting Piece for 11967, for 11-13, 11-14, 11-16 and 11-17 Machines
11967	1813	Feed Dog Adjusting Piece Carrier for 11-13, 11-14, 11-16 and 11-17 Machines
11967	1813	Feed Dog Carrier for 11-11, 11-12, 11-15, 11-18 to 11-20 and 11-22 Machines....
190D	1824	Feed Dog Screw for 11-8, 11-13, 11-14, 11-16, 11-17, 11-21 and 11-24 Machines
11968	1812	Feed Dog Slide for 11-1 and 11-4 Machines
12040	1802	" Forked Connection for 11-3, 11-4 and 11-6 Machines.....
11970	1813	Feed Regulator for 11-3, 11-4 and 11-6 Machines.....
2117	1828	Feed Regulator Crank Pin for 11-8 Machine.....
449c	1852	Feed Regulator Crank Set Screw for 11-8 Machine.....
283D	1813	Feed Regulator Thumb Screw for 11-3, 11-4, 11-6, 11-11 to 11-14, 11-17 and 11-21 Machines.....
207F	1852	Feed Rod Spring Screw for 11-8, 11-13, 11-14, 11-16, 11-17, 11-21 and 11-24 Machines.....
5667	1857	Foot Lever for 5668.....
5669	1857	" " Bracket for 5668.....
5671	1828	" " Hinge Pin for 5668.....
5672	1812	" " Lifting Spring for 5668.....
5668	1857	" " 5667 with 5669, 5671 and three wood screws 1½ in. No. 16, for 11-6 Machine.....
14698	1893	Hand Driving Attachment Gear for 14709.....
14699	1893	Hand Driving Attachment Gear Cover for 14698, for 14709.....



NO.	PLATE	NAME
164d	1852	Hand Driving Attachment Gear Cover Screw for 14709.....
14703	—	Hand Driving Attachment Lever Spring Eyelet for 14709.....
14704	1893	Hand Driving Attachment Pinion for 14698, for 14709.....
14585	1807	Lifting Presser Bar Bell Crank with 1518E, 1828 and 2718, for 11-15 and 11-22 Machines.....
11463	1809	Lifting Presser Bar Guide Bracket with 159d and 453c, for 11-4 Machine.....
11405	1807	Lifting Presser Bar Guide Bracket Guide for 11-19 Machine.....
381d	1851	Lifting Presser Bar Guide Bracket Guide Screw for 11-19 Machine.....
11407	1806	Lifting Presser Bar Lifter with 7958, 8761, 8763 and 8765, for 11408 and 11499....
11408	1806	Lifting Presser Bar Lifting Link for 11-4 Machine.....
11499	1806	Lifting Presser Bar Lifting Link for 11-3 and 11-6 Machines, use 11907.....
7958	1828	Lifting Presser Bar Lifting Link Hinge Stud Pin for 11-15 and 11-22 Machines.....
11494	1810	Lifting Presser Bar Spring Bracket for 11-18 and 11-20 Machines.....
2002	1828	Lifting Presser Bar Spring Guide Pin for 11-18 and 11-20 Machines.....
11380	1805	Needle Bar for 11-15, 11-16 and 11-22 Machines.....
11381	1814	Needle Bar Connecting Link for 11-15, 11-16, 11-18 to 11-20 and 11-22 Machines, use 11539.....
14508	1811	Needle Bar Frame with 14620, for 11-16 Machine.....
14533	1811	Needle Bar Frame Pitman for 11-16 Machine.....
23c	1851	Needle Bar Frame Pitman Hinge Screw for 11-16 Machine.....
14509	1811	Needle Bar Frame Pitman Hinge Stud for 11-16 Machine.....
164d	1852	Needle Bar Frame Pitman Hinge Stud Screw for 11-16 Machine.....
9043	1826	Needle Bar Frame Washer for 11-16 and 11-24 Machines.....
11384	1825	Needle Clamp with 245F, 11385 and 11386, for 11-1, 11-3, 11-4 and 11-6 Machines, use 19702.....

NO.	PLATE	NAME
11847	1825	Needle Clamp with 245F and 11385, for 11-1, 11-3, 11-4 and 11-6 Machines, use 19702.....
245F	1851	Needle Clamp Set Screw for 11384 and 11847.....
11386	1825	Needle Clamp Thread Eyelet for 11384..
11387	1857	Oil Cup for 11920.....
11920	1857	Oil Cup complete for 11-1 Machine, Nos. 2205, 8482, 9084, 11387, 11917 to 11919, two 8953 and three 207F.....
135d	1852	Oil Cup Screw for 11-8, 11-11 to 11-22 and 11-24 Machines.....
11983	1804	Oscillating Rock Shaft with 197E, 2170, 11984, 14657 and two 11985, for 11-1, 11-3, 11-4 and 11-6 Machines.....
2170	1826	Oscillating Rock Shaft Oil Pad for 11983.
197E	1852	“ “ “ “ Screw for 11983.....
304c	1852	Oscillating Rock Shaft Screw Centre for 11-1, 11-3, 11-4 and 11-6 Machines....
1513E	1824	Oscillating Rock Shaft Screw Centre Nut for 11-1, 11-3, 11-4 and 11-6 Machines.
11984	1815	Oscillating Rock Shaft Steel Plate (left) for 11983.....
14657	1815	Oscillating Rock Shaft Steel Plate (right) for 11983.....
11985	1828	Oscillating Rock Shaft Steel Plate Rivet for 11983.....
11979	1800	Oscillating Shaft for 11-1 Machine.....
14589	1800	“ “ “ 11-16 and 11-24 Machines.....
11981	1824	Oscillating Shaft Crank with 453c and 1807, for 11-1, 11-3, 11-4 and 11-6 Machines.....
12089	1823	Oscillating Shaft Crank complete for 11-3, 11-4 and 11-6 Machines, Nos. 453c, 1513E, 1885 and 12088.....
13325	1824	Oscillating Shaft Crank complete for 11-1 Machine, Nos. 453c, 1513E, 1885 and 13324, use 13416.....
1885	1824	Oscillating Shaft Crank Roller and Screw Stud for 12089 and 13325.....
1807	1824	Oscillating Shaft Crank Roller and Stud for 11981.....
14510	1806	Presser Bar Lifter for 11-16 Machine....
568d	1851	“ “ “ Hinge Screw for 11-16 Machine.....

NO.	PLATE	NAME
258E	1854	Presser Bar Screw Bushing for 11-16 Machine.
14571	1845	Presser Foot (left of needle) for 14569, for 11-17 Machine.
12019	1819	Shuttle Cylinder for 12018.
14661	1819	" " " 14516.
12020	1819	" " Latch Spring for 12018 and 14516.
223D	1819	Shuttle Cylinder Latch Spring Screw for 12018 and 14516.
12021	1819	Shuttle Frame for 12018 and 14516.
774C	1821	" Tension Regulating Screw for 12018.
12022	1819	Shuttle Tension Spring for 12018.
12018	1819	Shuttle (cylinder) 2½ in. diam., complete, for 11-1 Machine, Nos. 223D, 774C, 12000, 12019 to 12022 and 14535.
14516	1819	Shuttle (cylinder) 2½ in. diam., complete, for 11-3, 11-4 and 11-6 Machines, Nos. 223D, 773C, 12000, 12020, 12021, 12095, 14535 and 14661.
12023	1823	Shuttle Driver and Feed Lifting Cam for 12018 and 14516, for 11-1, 11-3, 11-4 and 11-6 Machines.
14511	1822	Shuttle Driver and Feed Lifting Cam for 14527 and 14765, for 11-16 and 11-24 Machines.
12098	1817	Shuttle Race for 11-3, 11-4 and 11-6 Machines.
12007	1816	Shuttle Race Ring for 11-1 Machine.
12041	1816	" " " " 11-3, 11-4 and 11-6 Machines.
391C	1851	Shuttle Race Ring Screw for 11-1, 11-3, 11-4 and 11-6 Machines.
132C	1852	Shuttle Race Screw for 11-3, 11-4 and 11-6 Machines.
14619	1814	Tension Bracket for 11-16 Machine.
11424	1829	Thread Eyelet (front of arm) for 11-8 Machine.
14620	1829	Thread Guard for 14508.
686D	1855	" Retaining Screw Stud for 11041.
11041	—	Thread Retainer complete for 11-16 Machine, Nos. 686D, 1560C, 2103, 8905 and two 2102.
1845	1854	Thread Take-up Lever Roller and Screw Stud for all machines except 11-23 to 11-26.

NO.	PLATE	NAME
1951	1889	Thread Take-up Lever Roller and Screw Stud with 1518E, for 19754.
14625	1829	Thread Take-up Spring Staple for 11-16 Machine.
164D	1852	Thread Take-up Spring Staple Screw for 11-16 and 11-24 Machines.
14520	1838	Throat Plate for 12072 and 14716, for 11-15 Machine.
14573	1845	Throat Plate for 14569, for 11-17 Machine.
14591	1843	" " " 14582.
14678	1843	" " " 12072 and 14716, for 11-15 Machine.
14519	1837	Throat Plate Holder for 11-15 Machine.
11949	1809	Vibrating Presser Bar for 11-4 Machine.
14592	1809	" " " " 11-15 and 11-22 Machines.
11468	1809	Vibrating Presser Bar Guide Bracket with 448C, for 11469.
11469	—	Vibrating Presser Bar Guide Bracket complete for 11-4 Machine, Nos. 11468, 11470 and two 190D.
11470	1809	Vibrating Presser Bar Guide Bracket Cap for 11469.
164D	1852	Vibrating Presser Bar Hinge Cap Screw for 11-4 Machine.
11473	1836	Vibrating Presser Foot for 11949, for 11-4 Machine.
14597	1843	Vibrating Presser Foot for 14592, for 11-15, 11-19 and 11-22 Machines.
14668	1850	Vibrating Presser Foot for 14679, for 14666 and 14725.
14671	1850	Vibrating Presser Foot for 14592, for 14669 and 14726.
14683	1887	Vibrating Presser Foot for 14592, for 14682.

SINGER Needles should be used  
in SINGER Machines.  
These Needles and their Containers  
are marked with the  
Company's Trade Mark "SIMANCO.\*\*\*" 1

Needles in Containers marked  
"FOR SINGER MACHINES"  
are NOT **SINGER** made needles. 2

PLATE 362—ONE-FOURTH SIZE

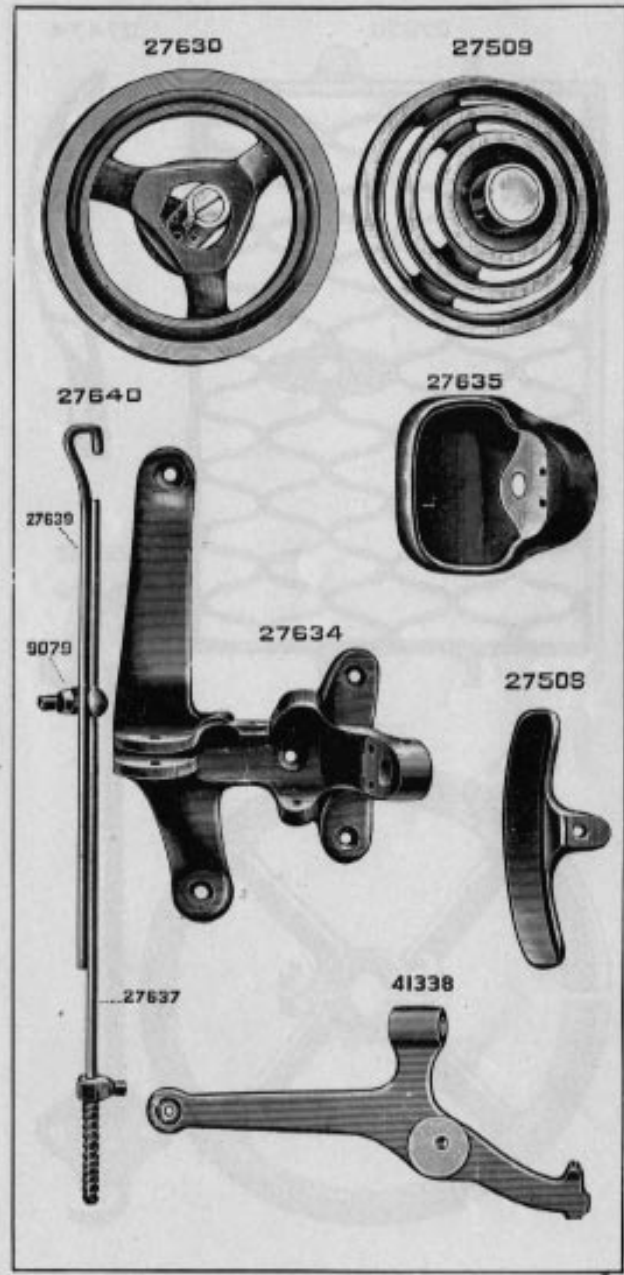


PLATE 363—ONE-FOURTH SIZE

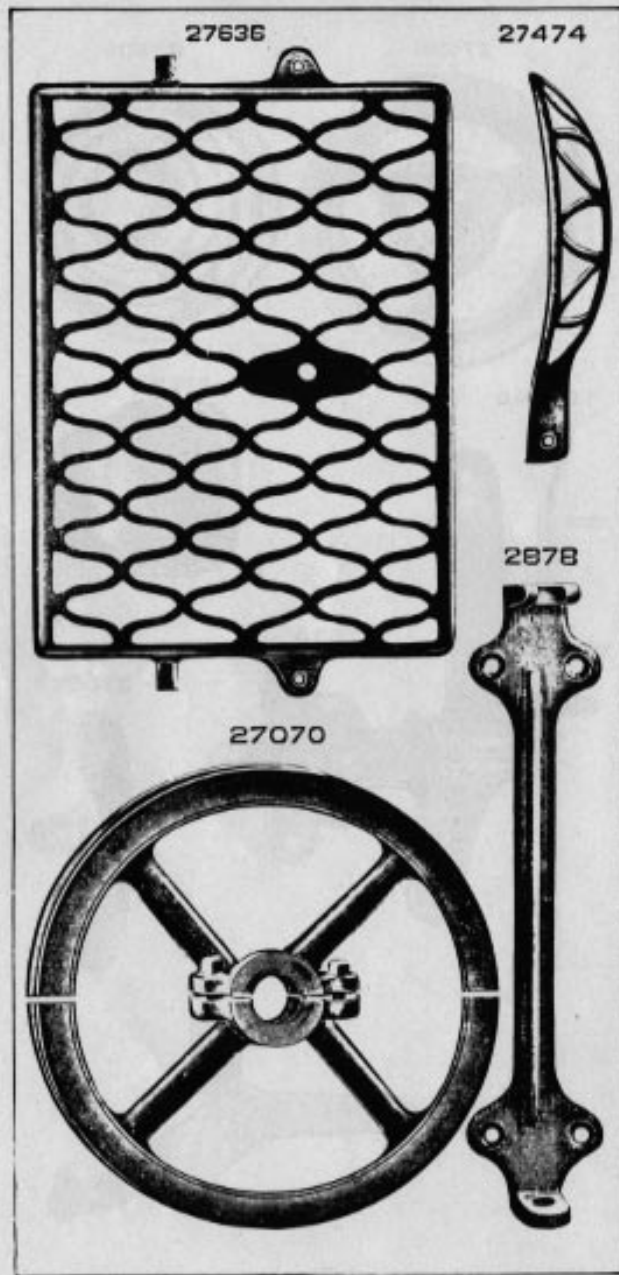


PLATE 1101—FULL SIZE †

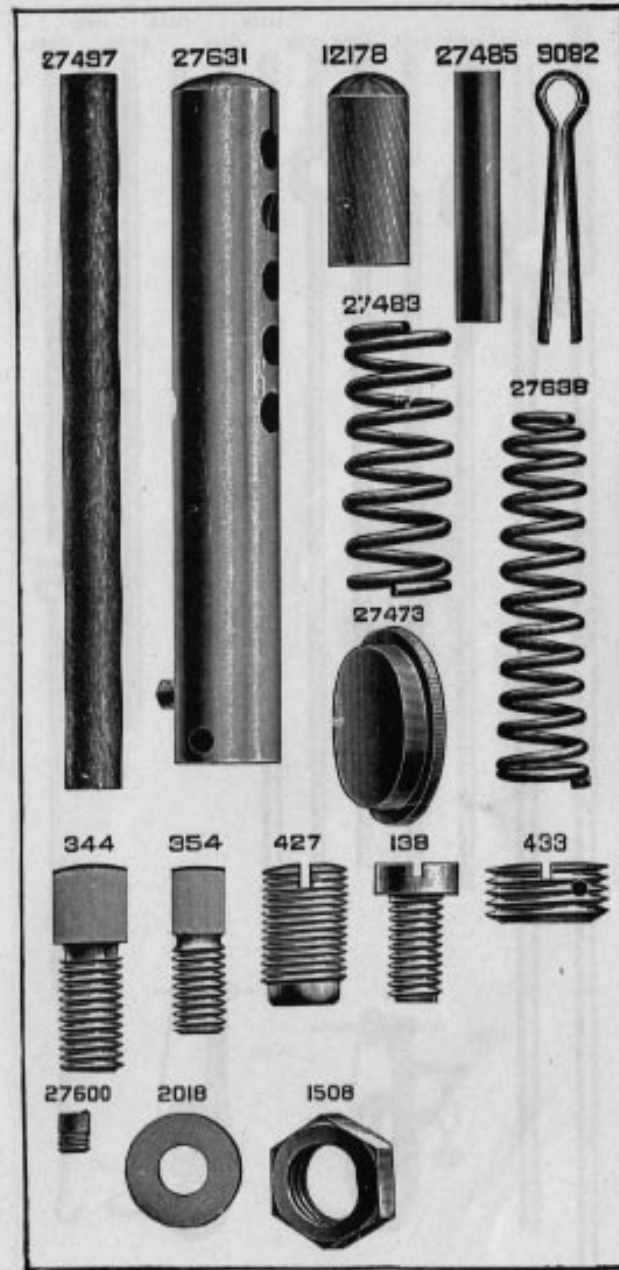


PLATE 1800—ONE-SIXTH SIZE >

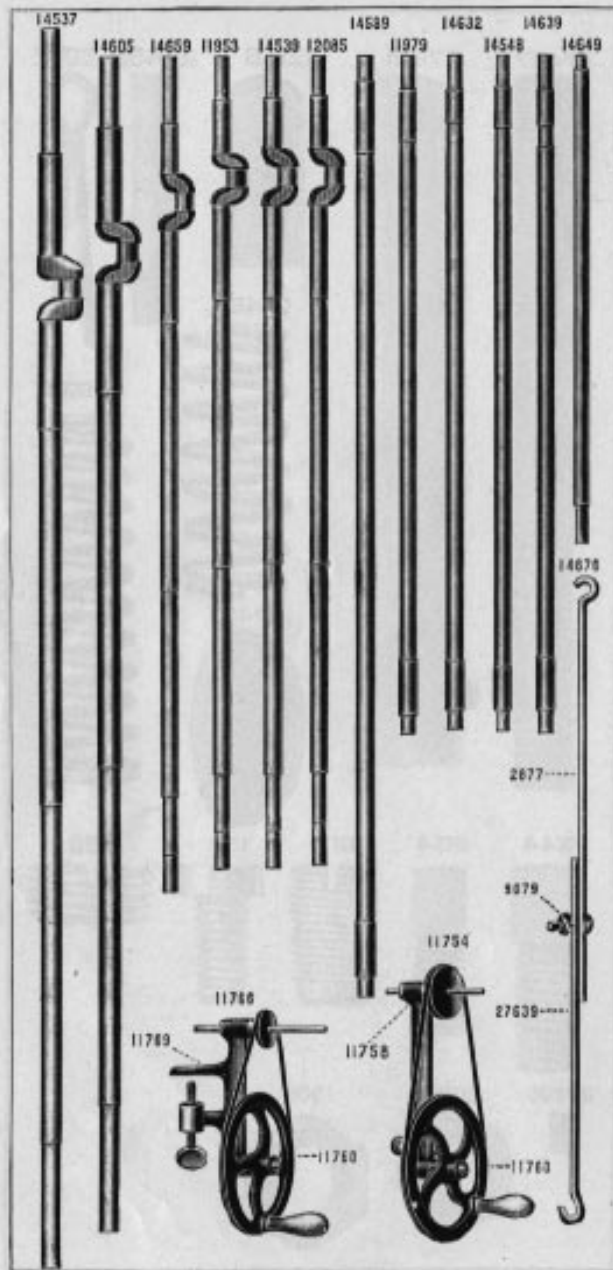


PLATE 1801—ONE SIXTH SIZE >

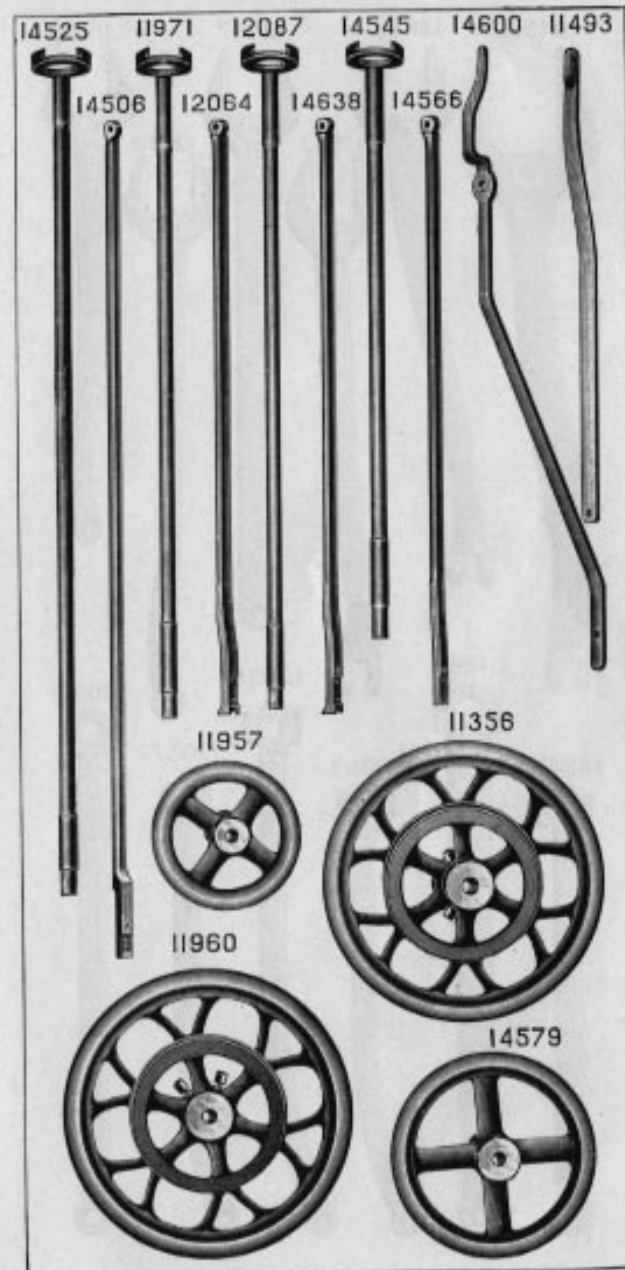


PLATE 1802—ONE-FOURTH SIZE ↘

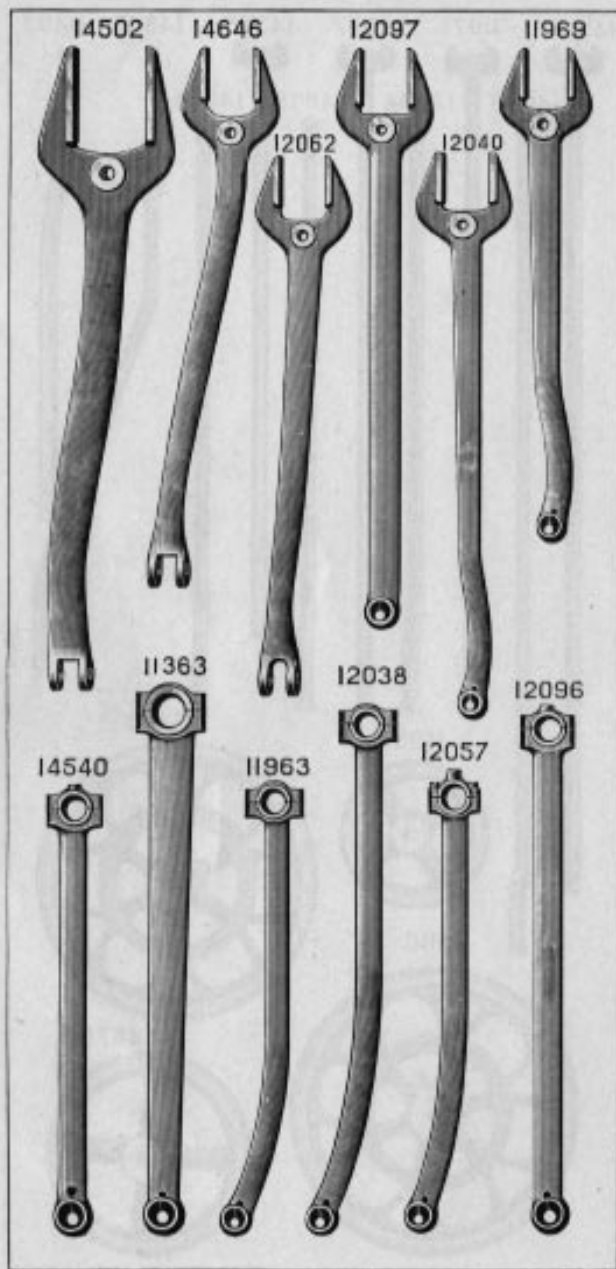


PLATE 1803—ONE-HALF SIZE ↘

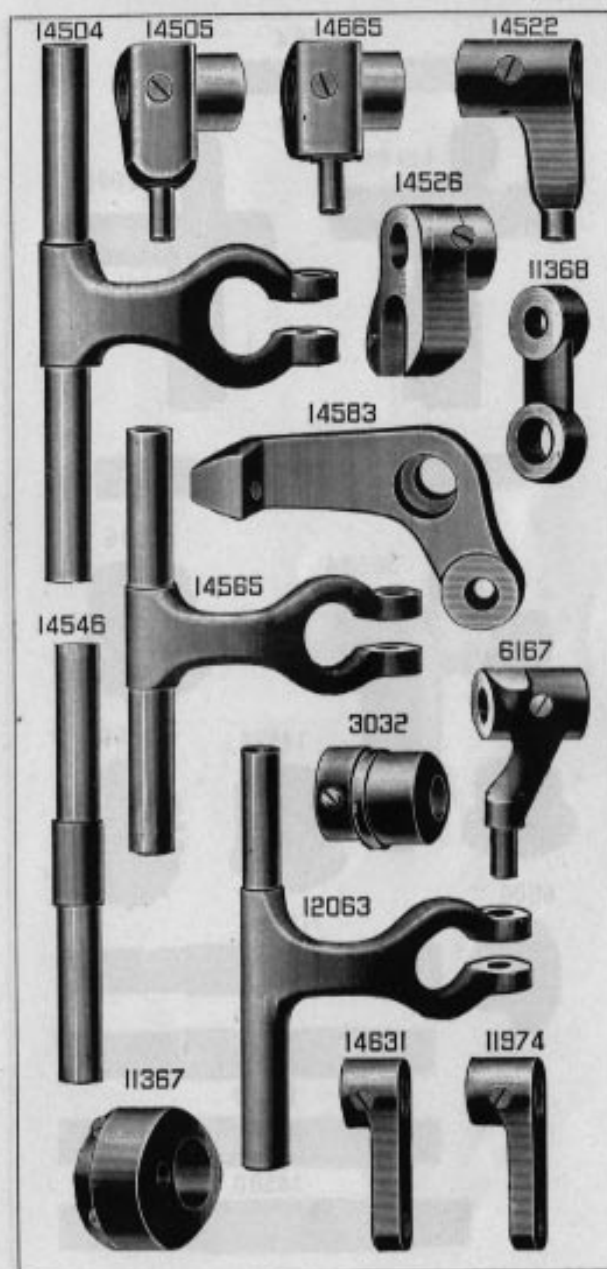


PLATE 1804—ONE-HALF SIZE †

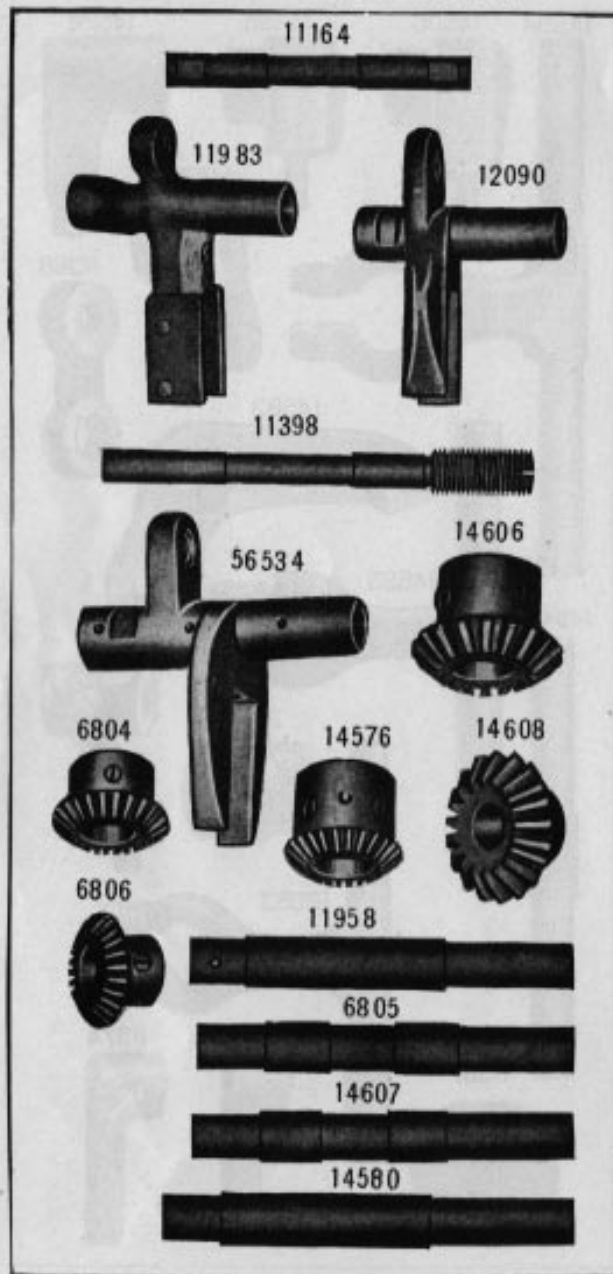


PLATE 1805—ONE-HALF SIZE †

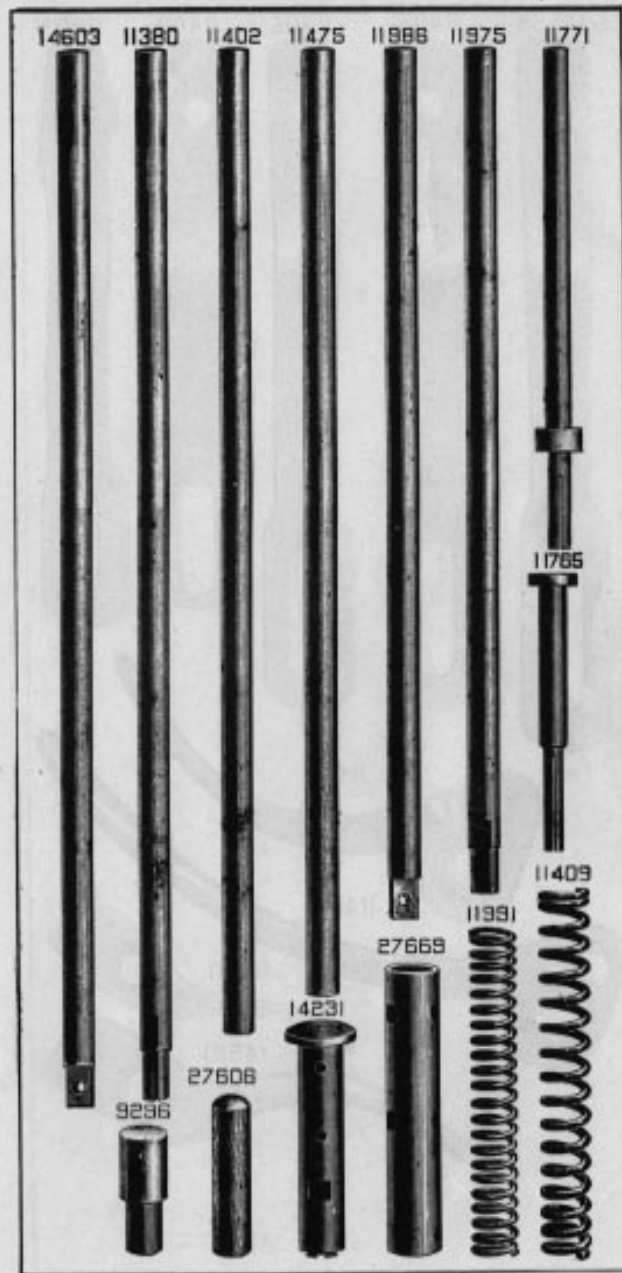




PLATE 1806—ONE-HALF SIZE

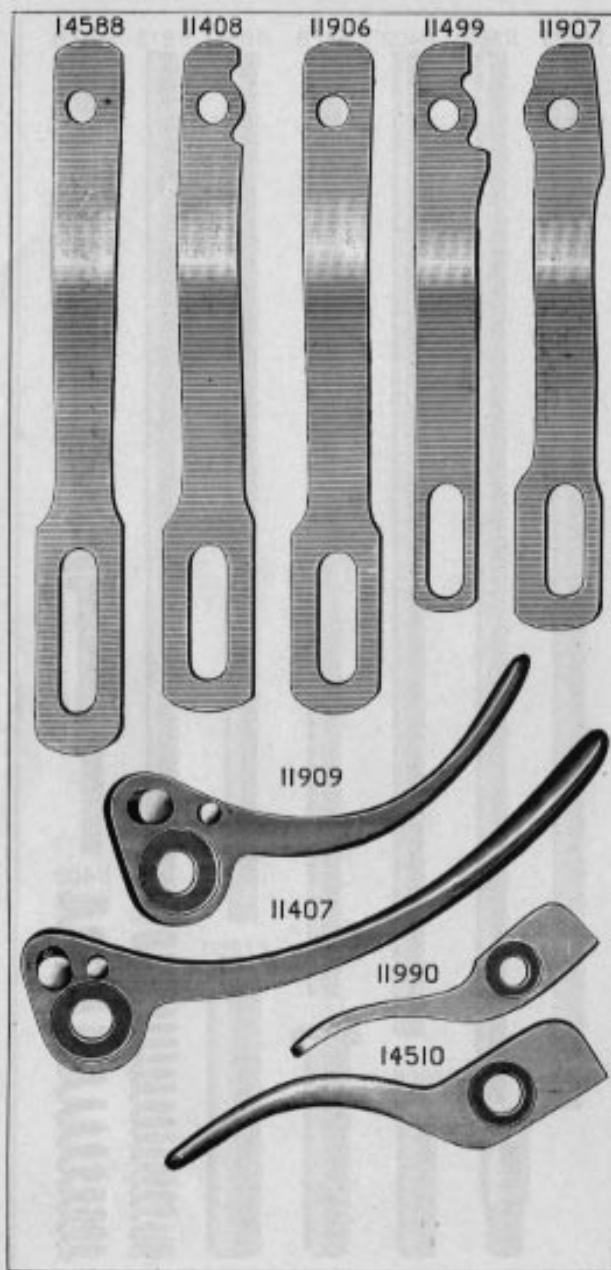


PLATE 1807—ONE-HALF SIZE

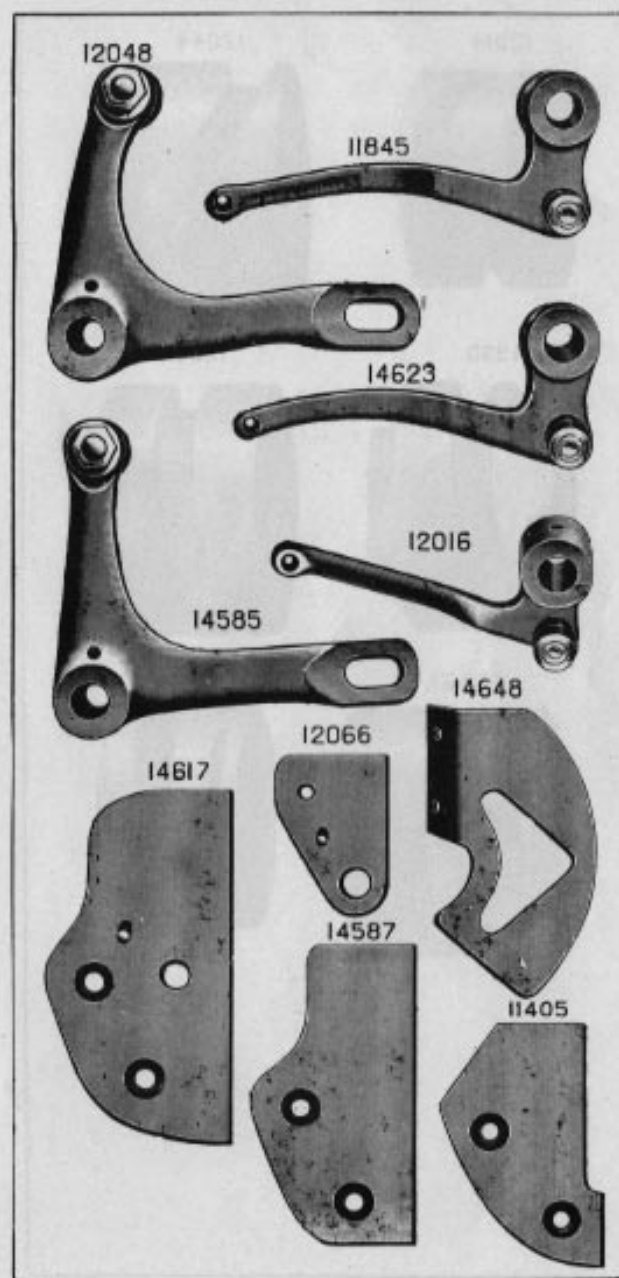




PLATE 1808—ONE-HALF SIZE ↘

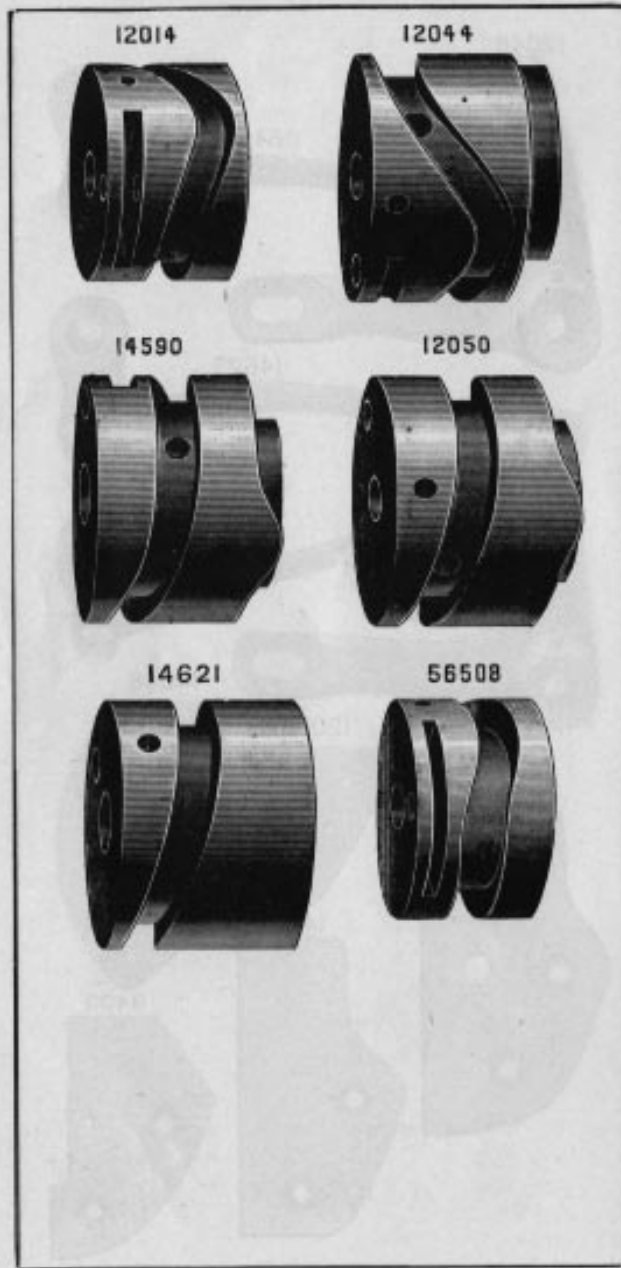


PLATE 1809—ONE-HALF SIZE ↘

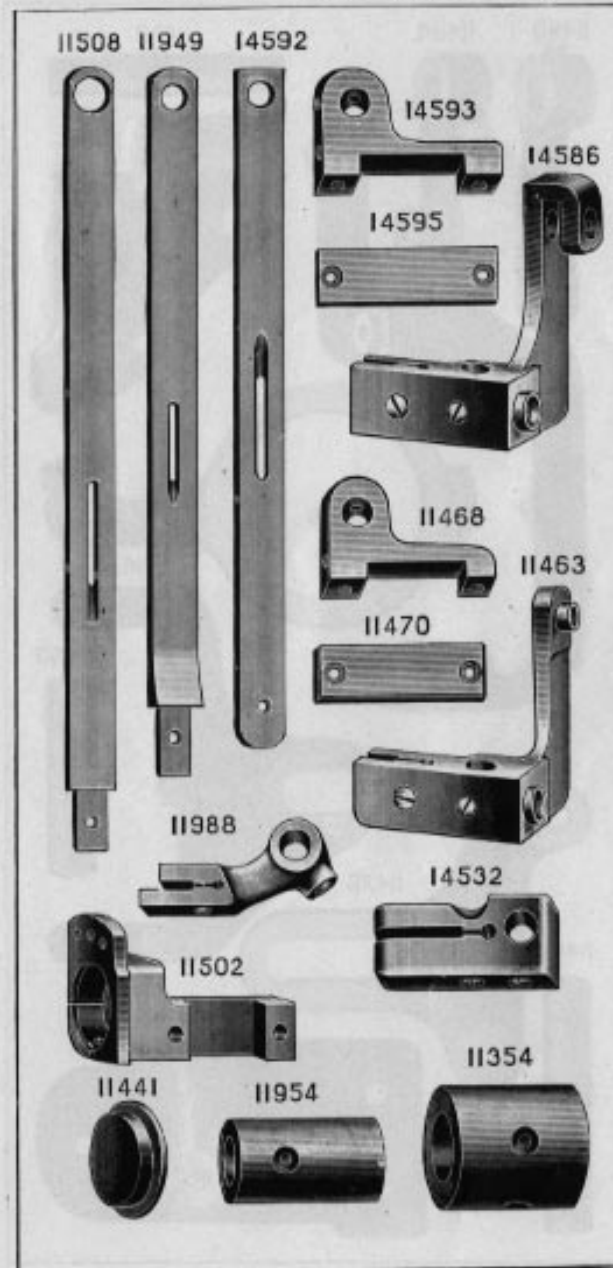


PLATE 1810—ONE-HALF SIZE

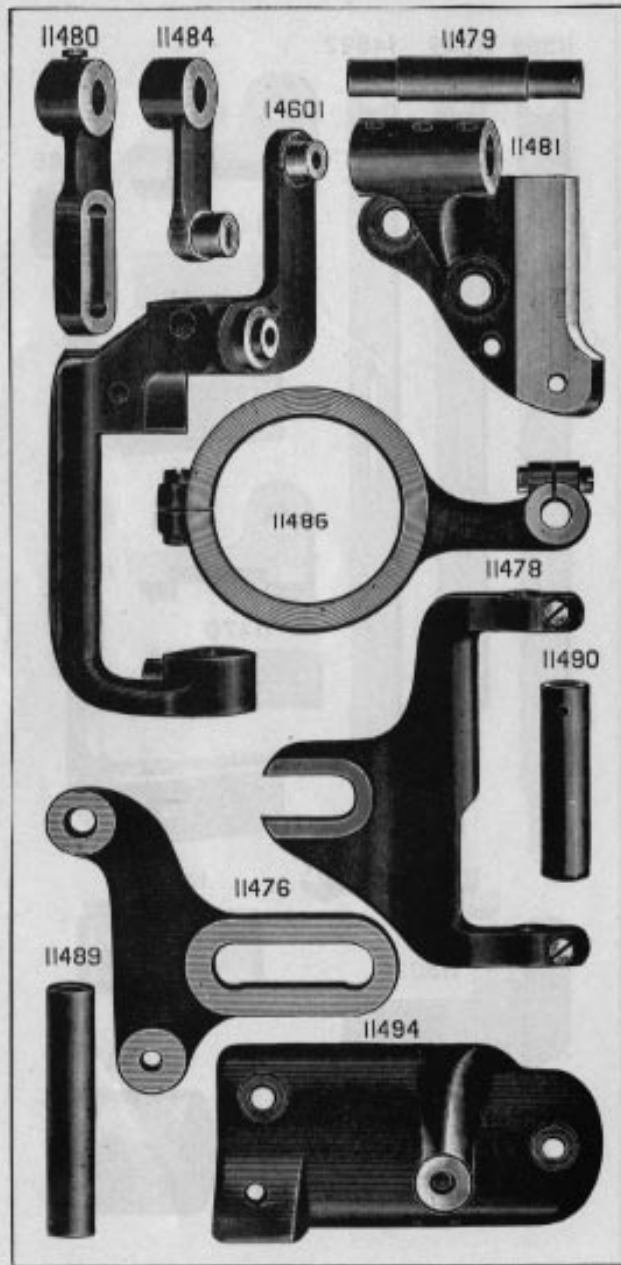


PLATE 1811—ONE-HALF SIZE

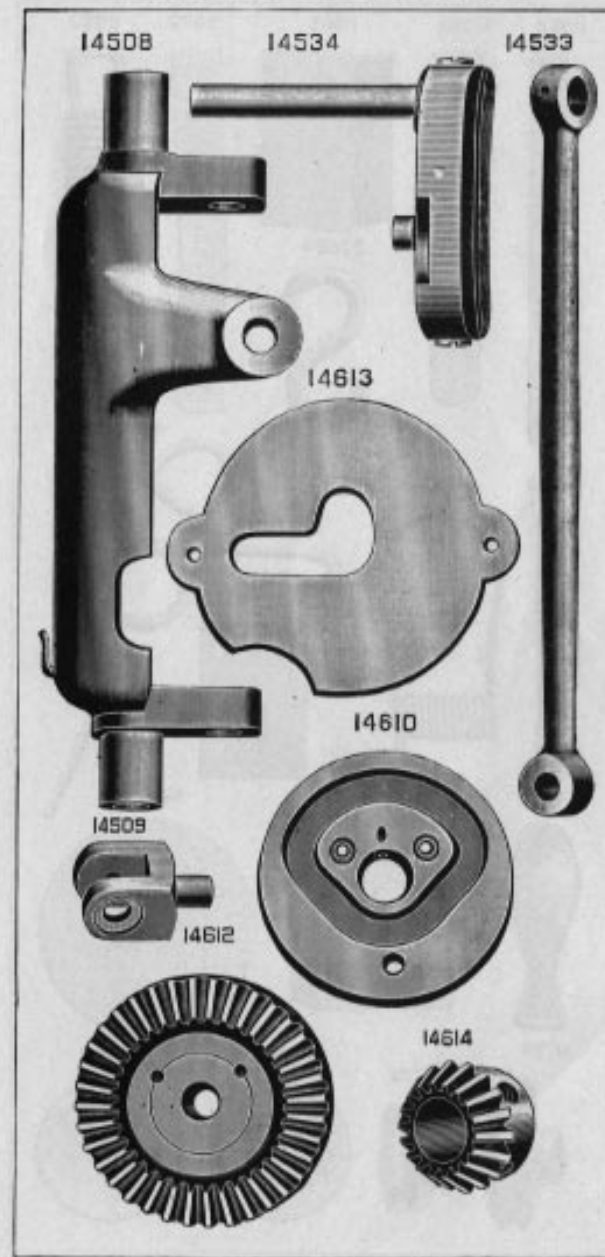


PLATE 1812—ONE-HALF SIZE



PLATE 1813—FULL SIZE

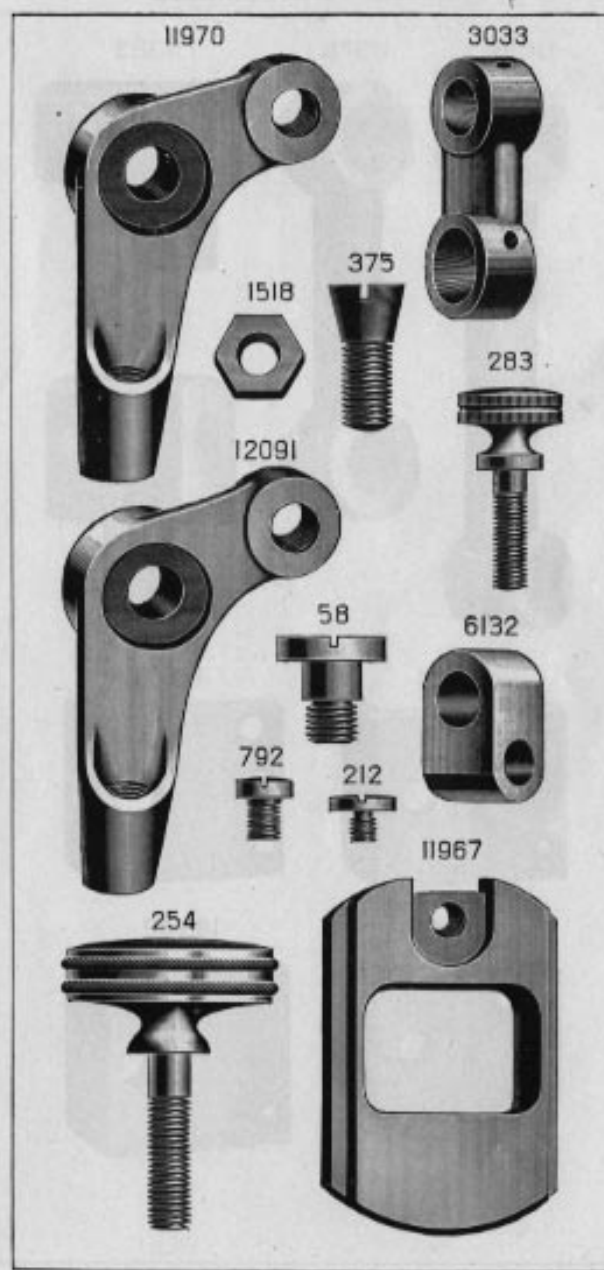


PLATE 1814—FULL SIZE ↗

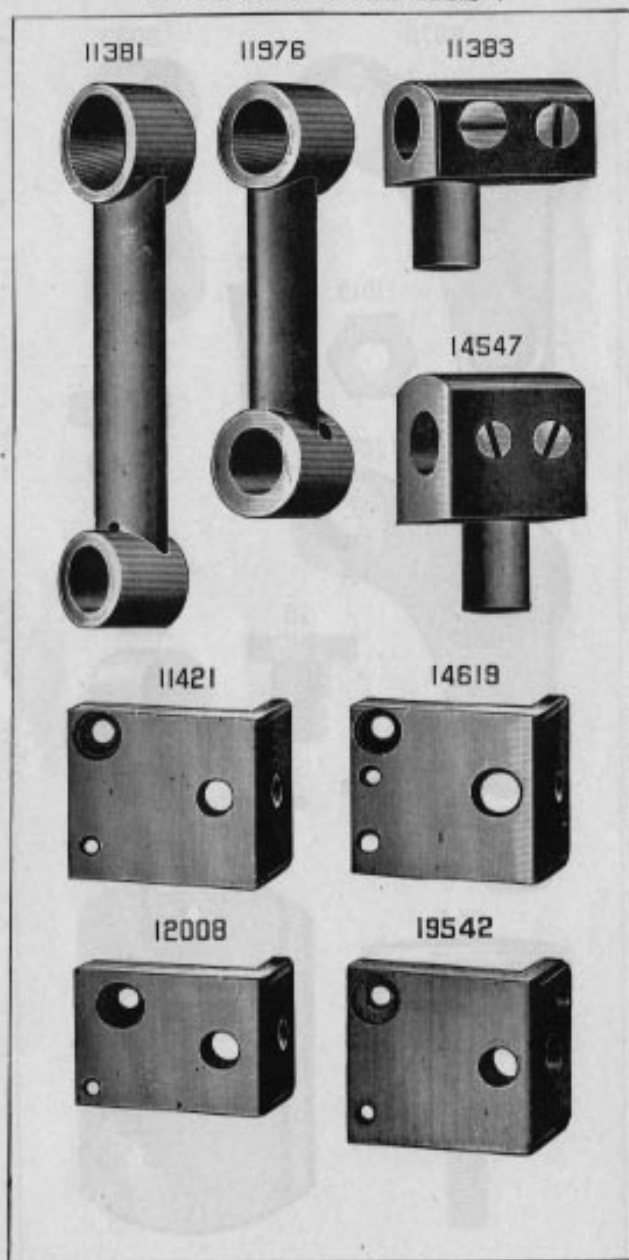


PLATE 1815—FULL SIZE ↗

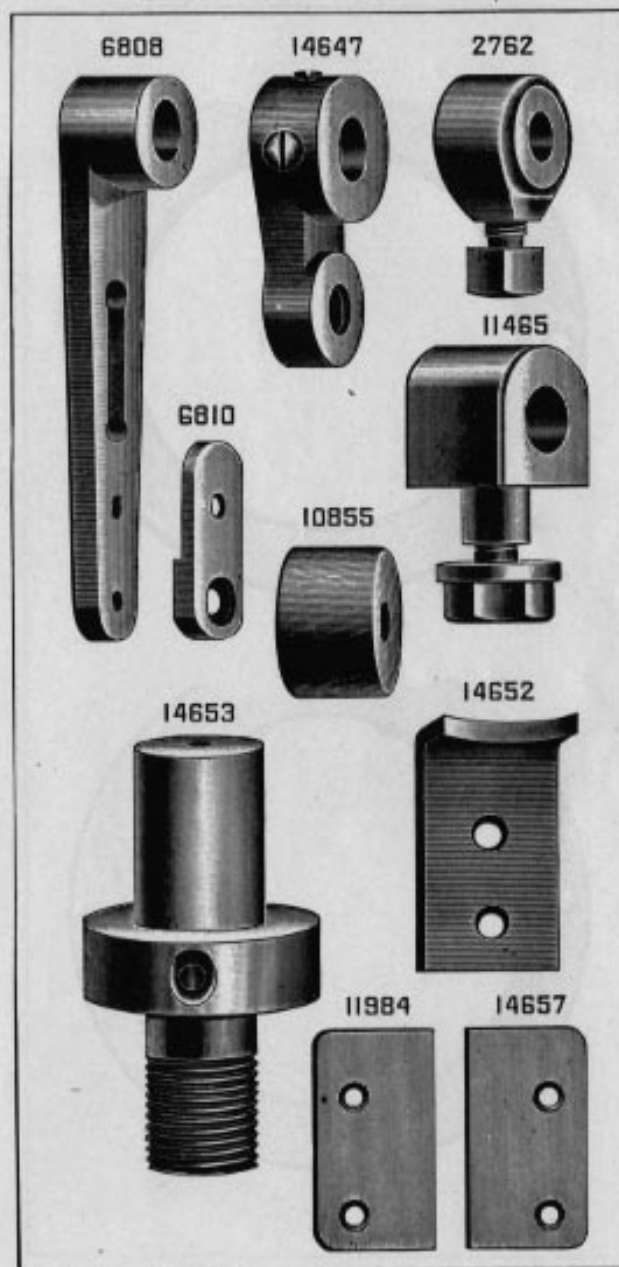
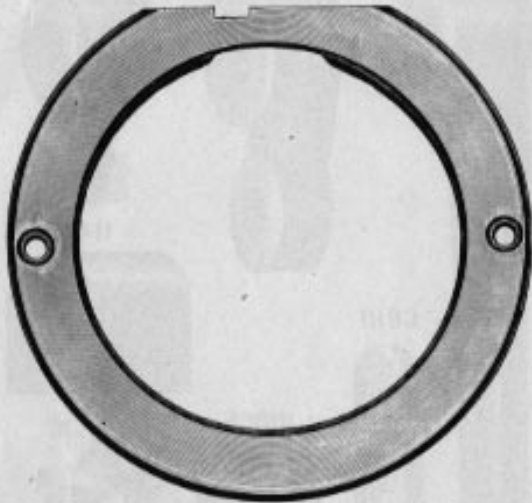


PLATE 1816—FULL SIZE

12007



12041

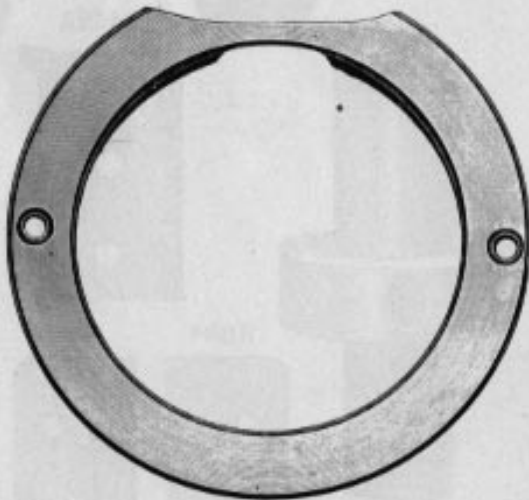


PLATE 1817—FULL SIZE

12069



12098

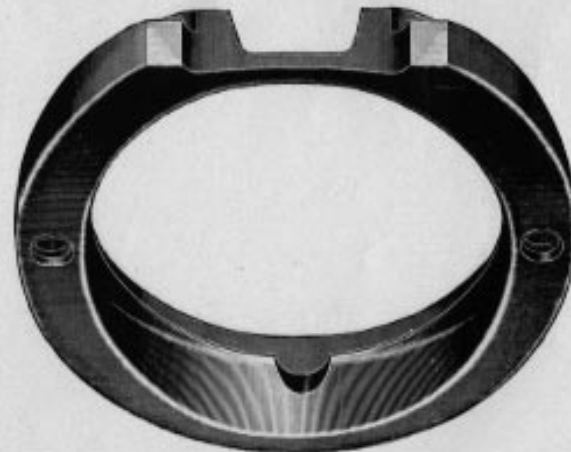
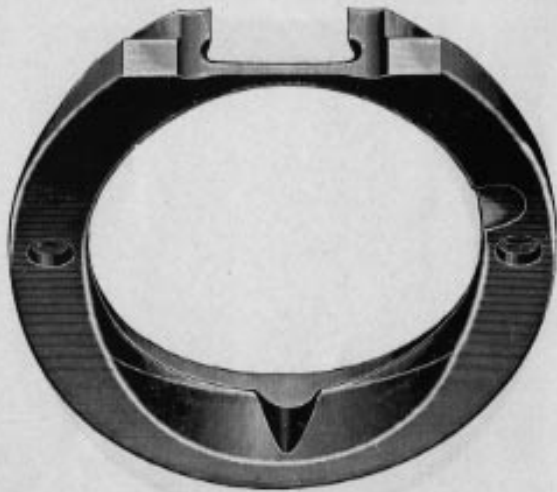




PLATE 1818—FULL SIZE ↗

14554



14618

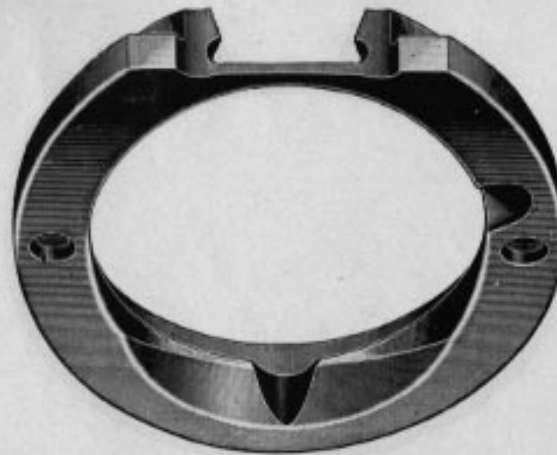


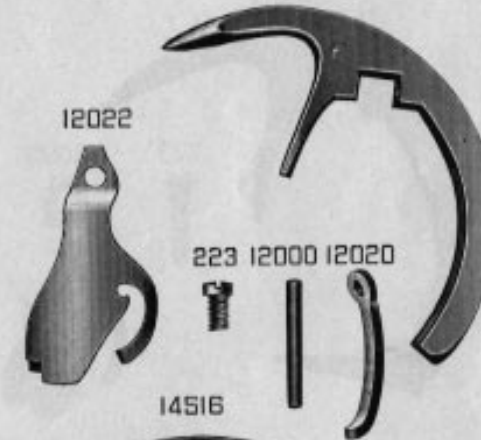
PLATE 1819—FULL SIZE ↘

12018



12019

12021



14516

14661



PLATE 1820—FULL SIZE

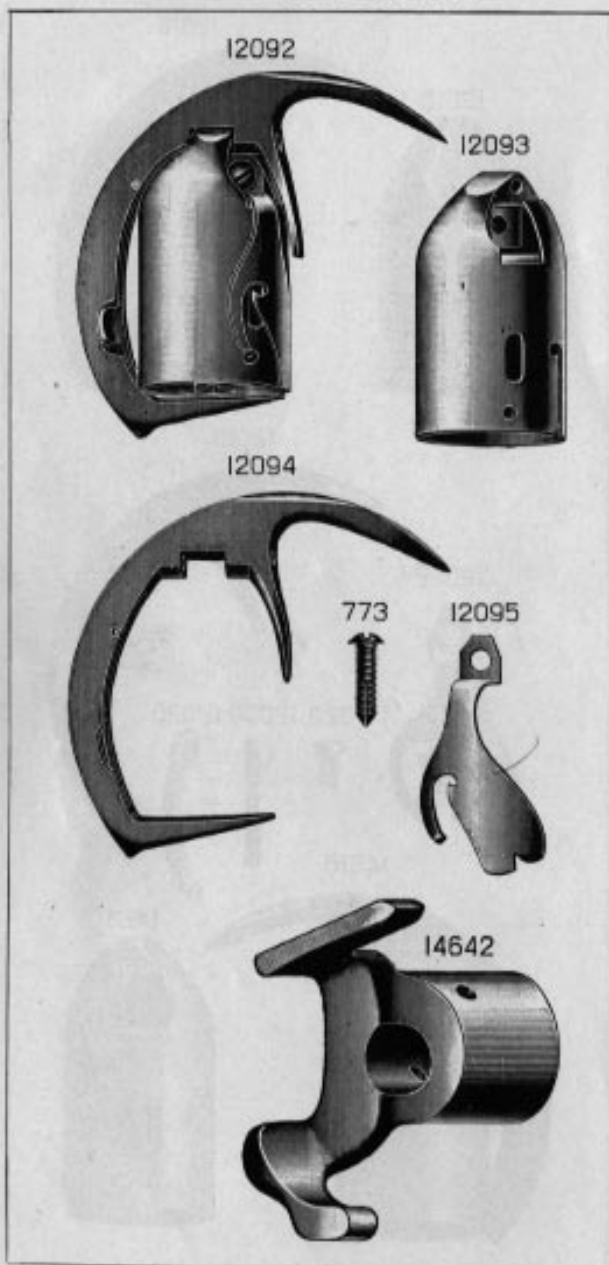


PLATE 1821—FULL SIZE

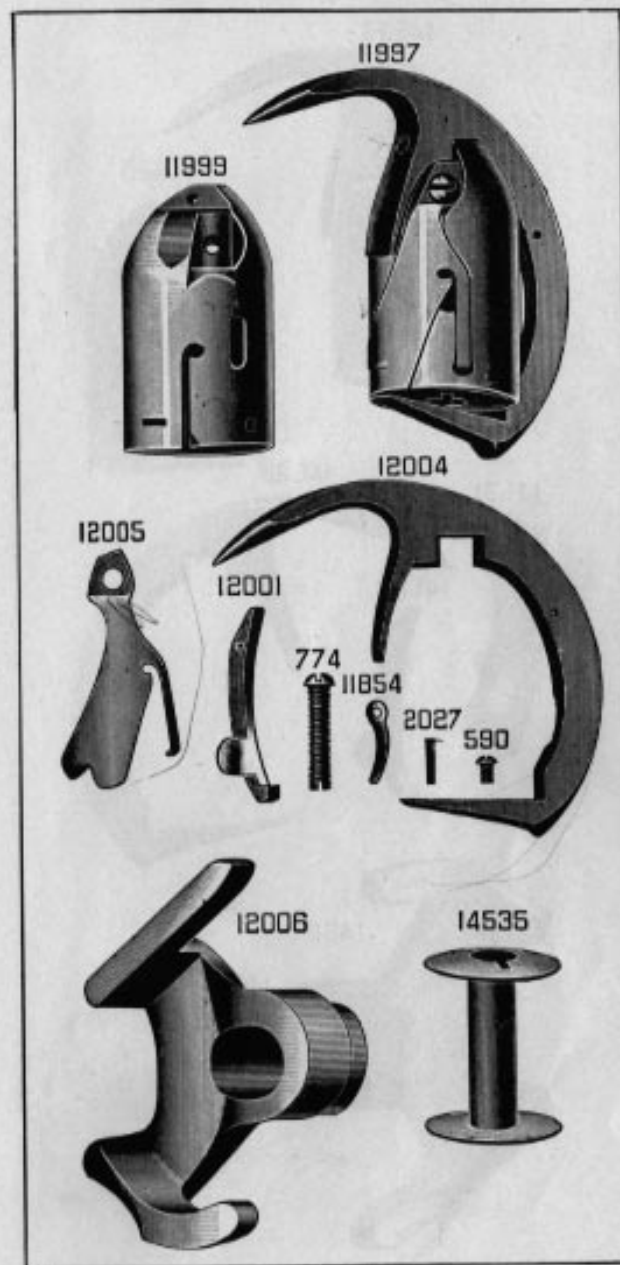


PLATE 1820—FULL SIZE

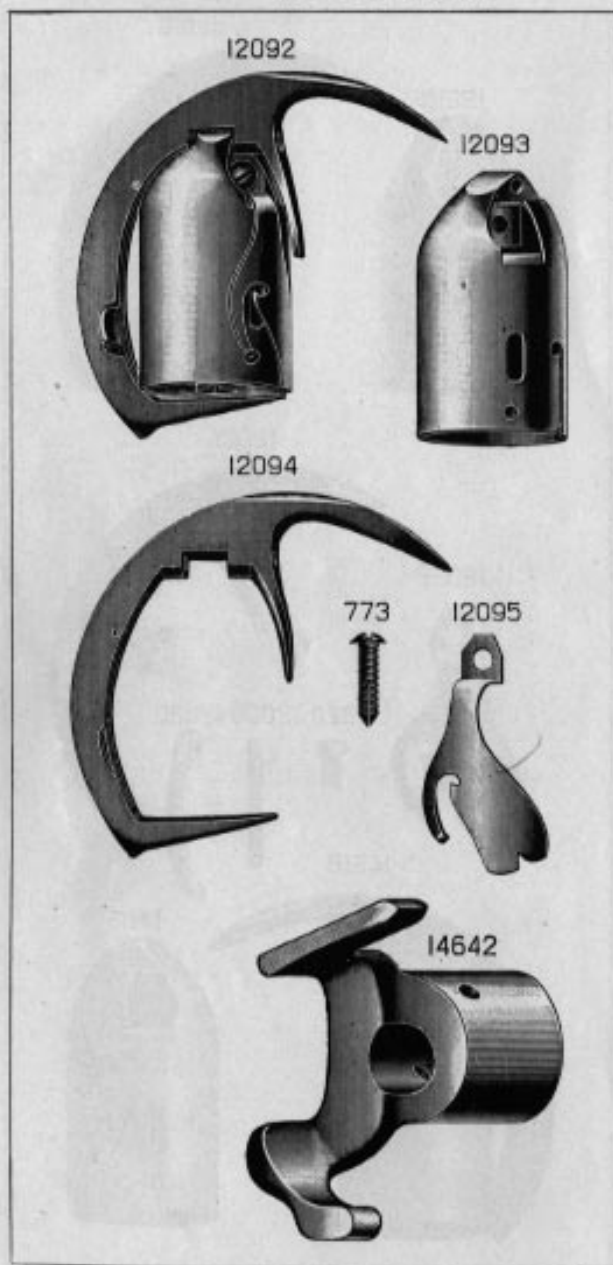


PLATE 1821—FULL SIZE

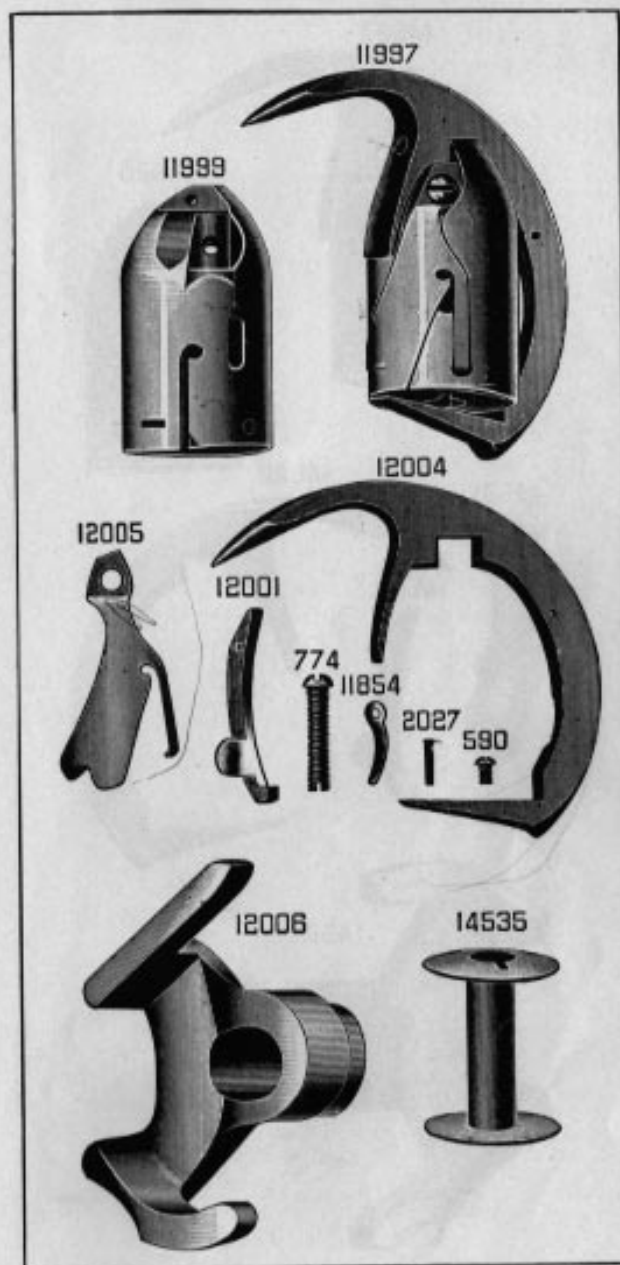




PLATE 1822—FULL SIZE

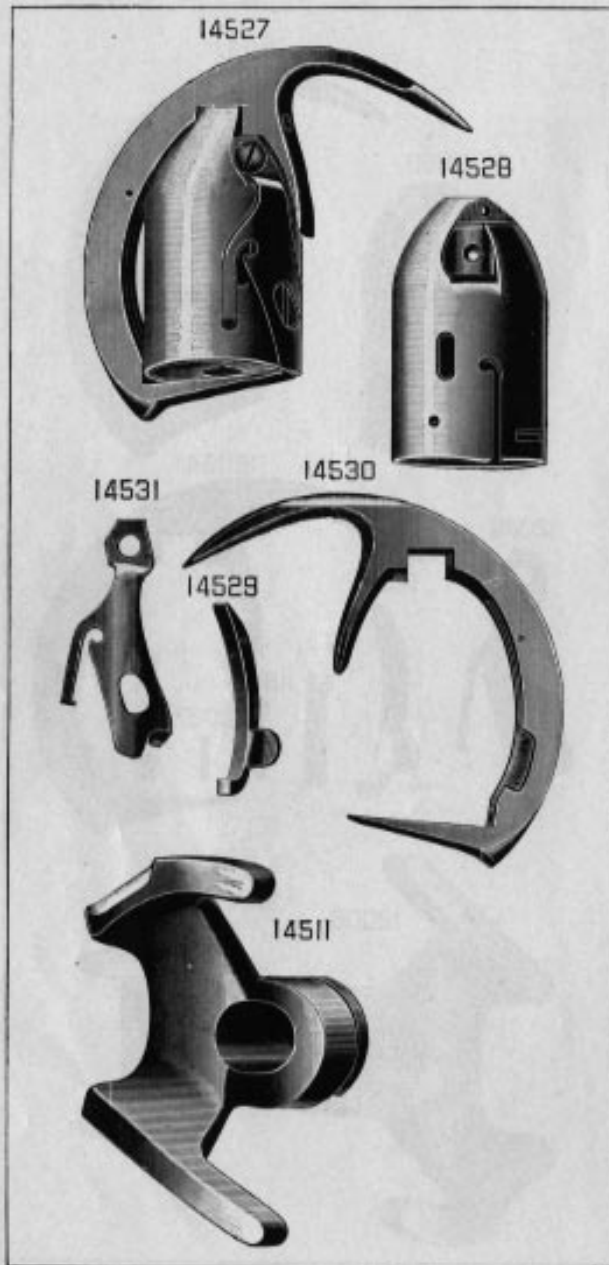


PLATE 1823—FULL SIZE

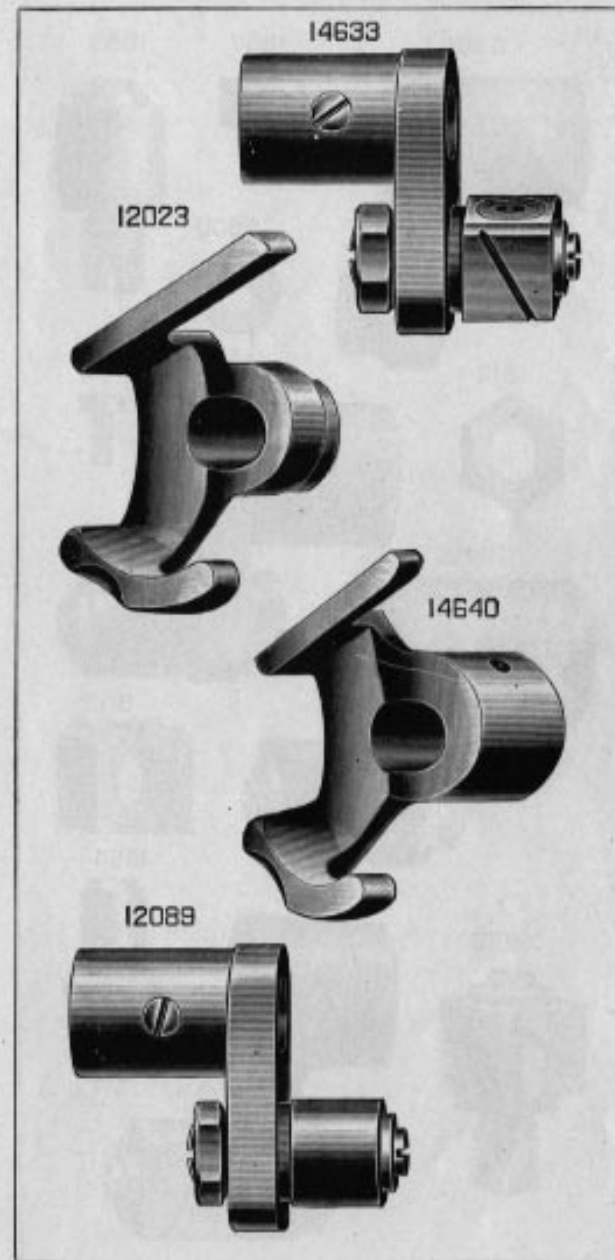


PLATE 1824—FULL SIZE

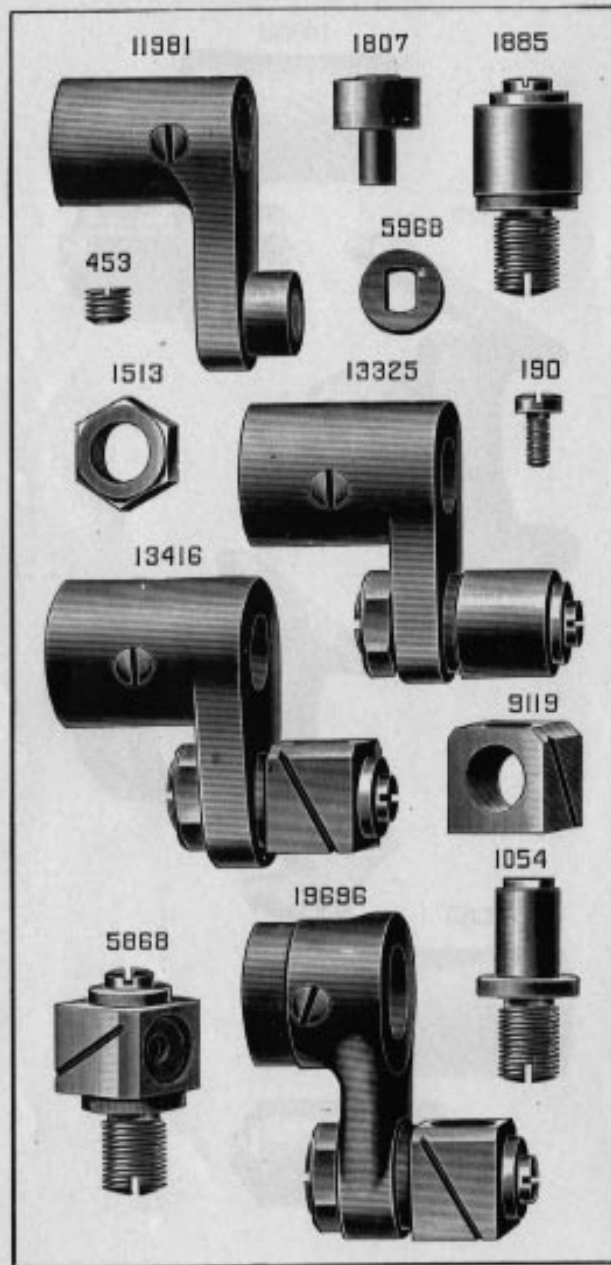


PLATE 1825—FULL SIZE

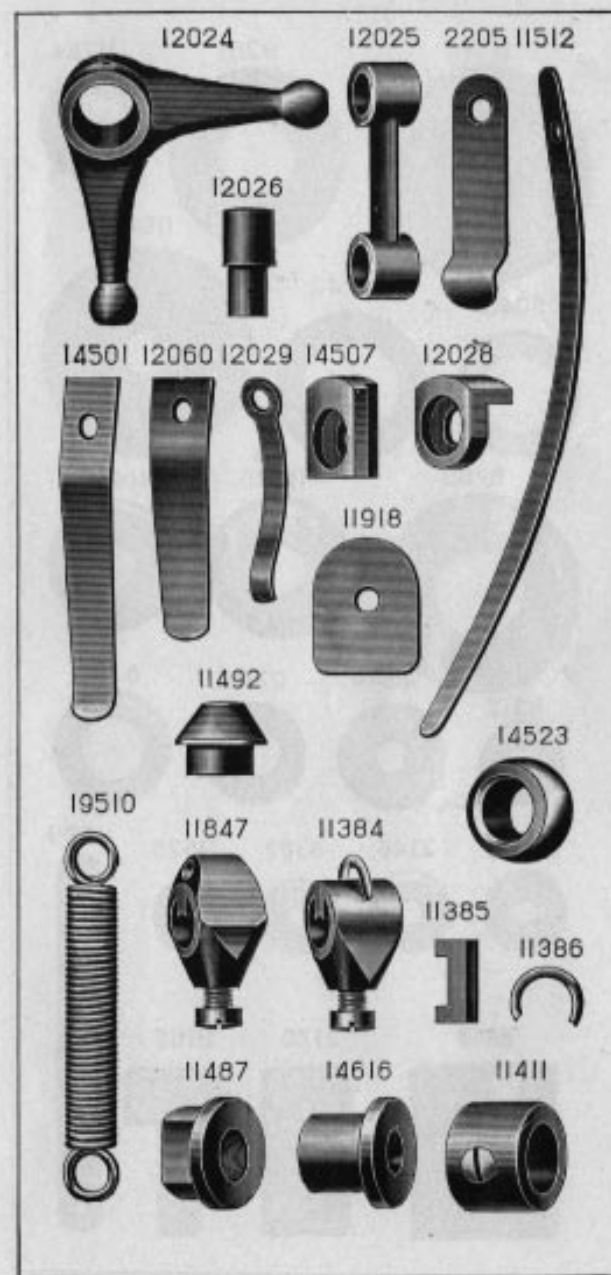


PLATE 1826—FULL SIZE

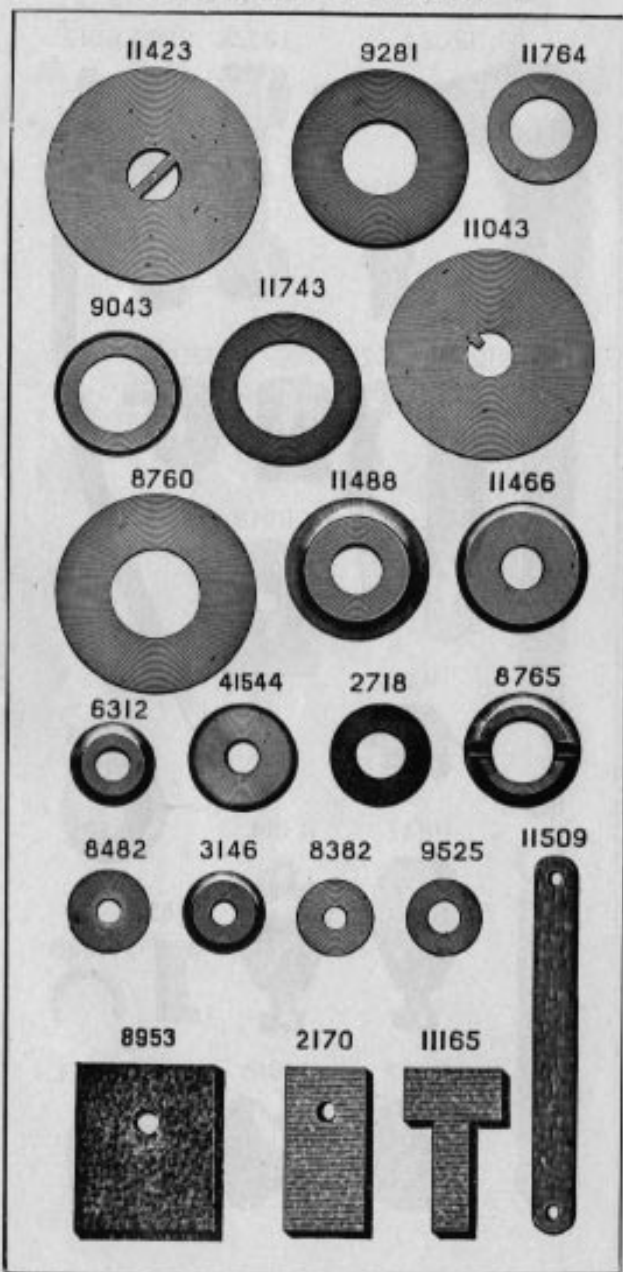


PLATE 1827—FULL SIZE

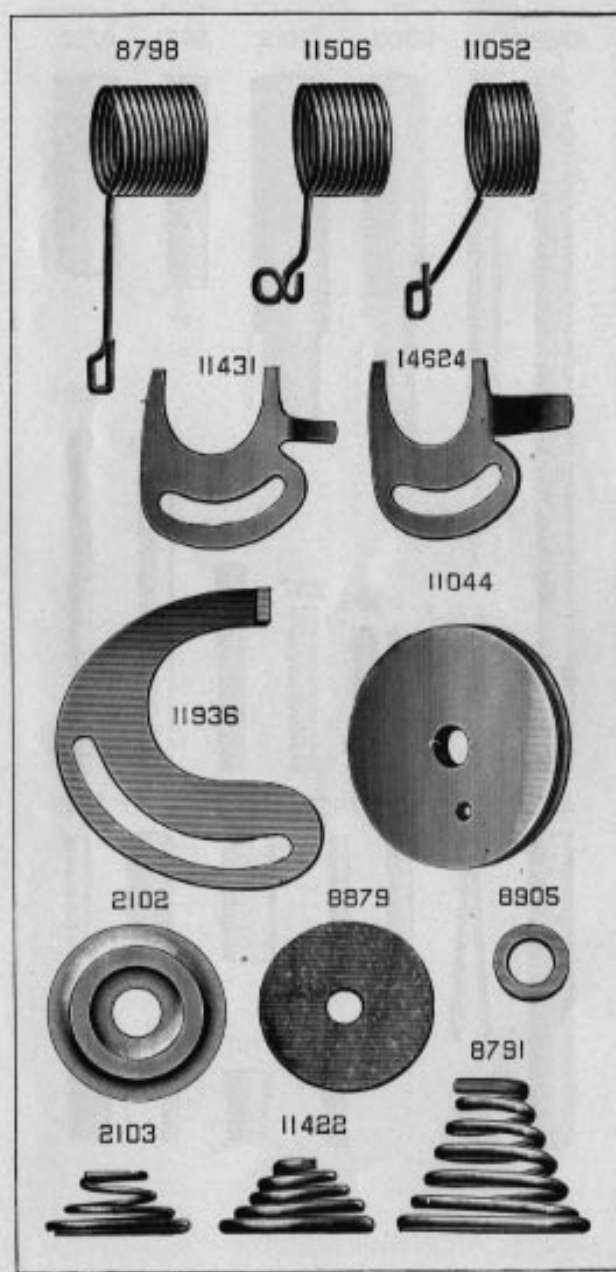


PLATE 1828—FULL SIZE †

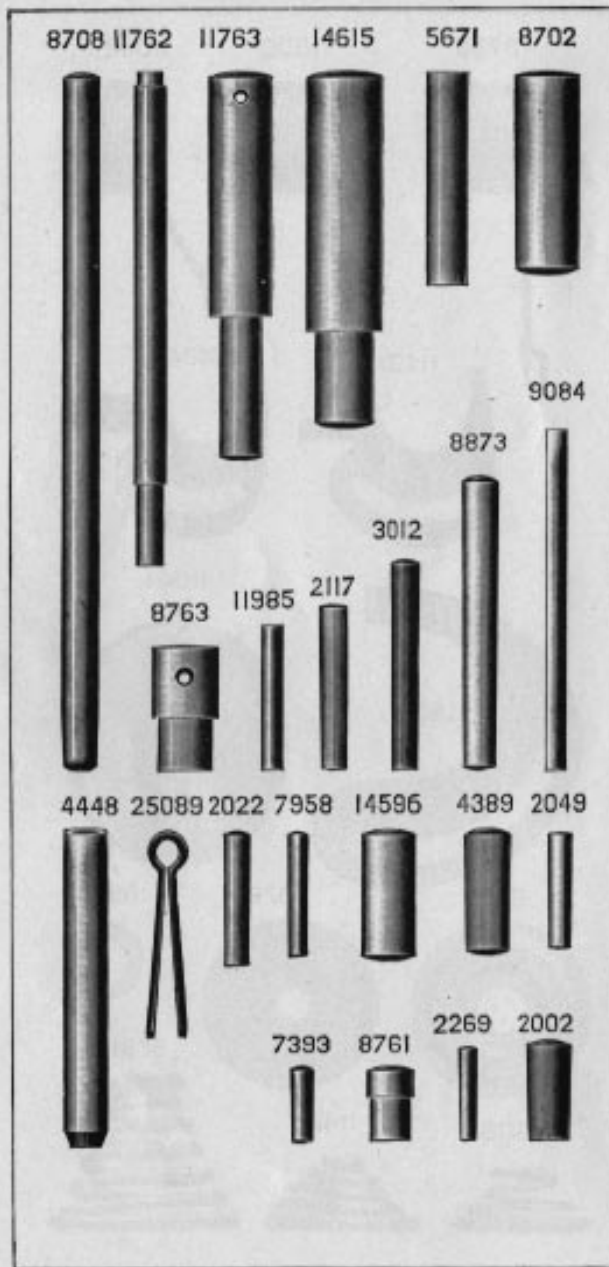


PLATE 1829—FULL SIZE †

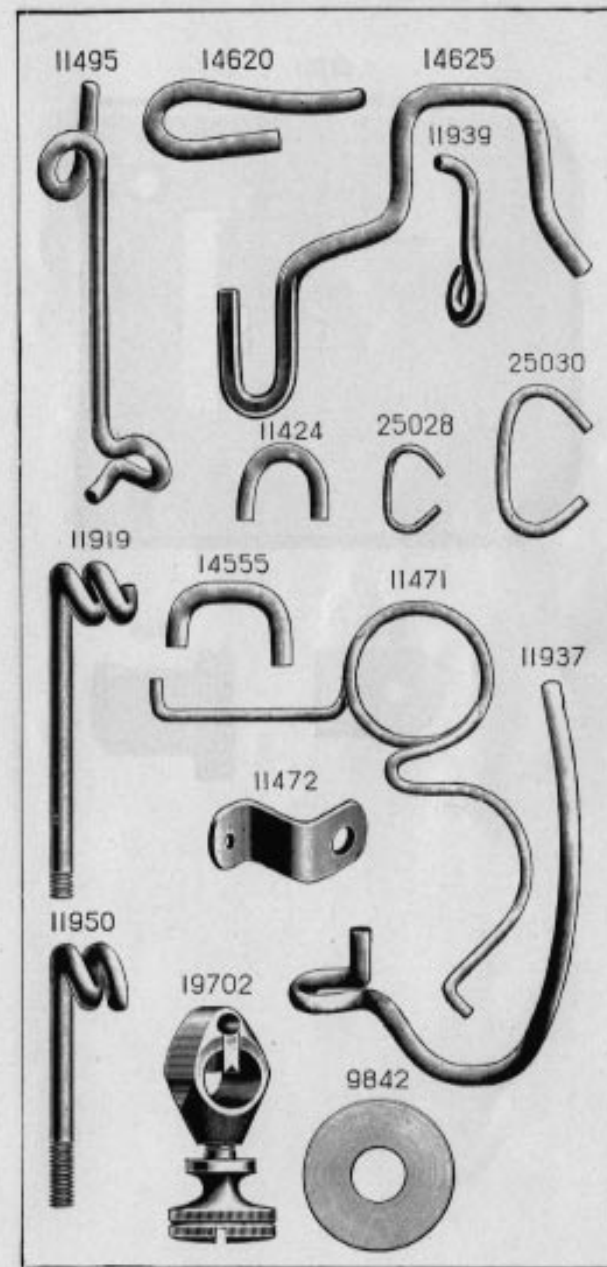
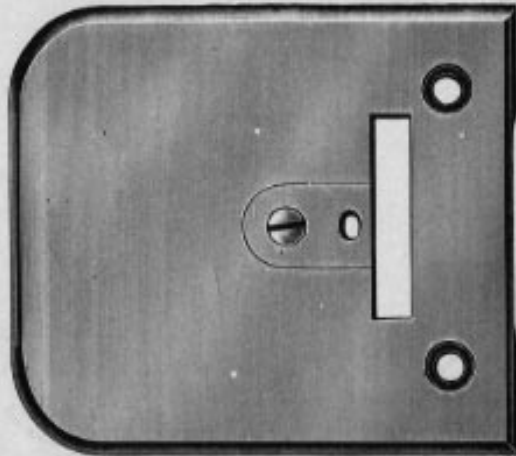


PLATE 1830—FULL SIZE

12011



12012



11966

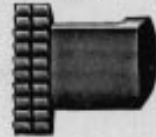
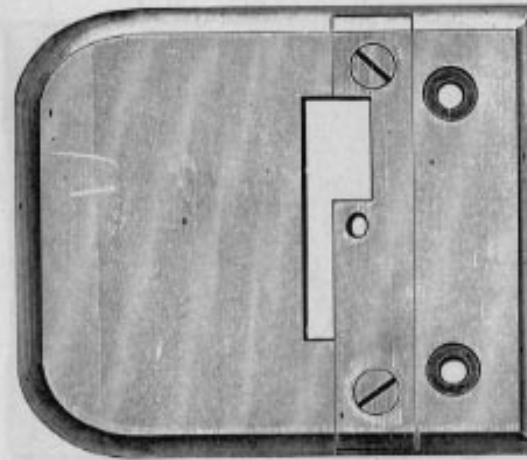


PLATE 1831—FULL SIZE

14517



12074

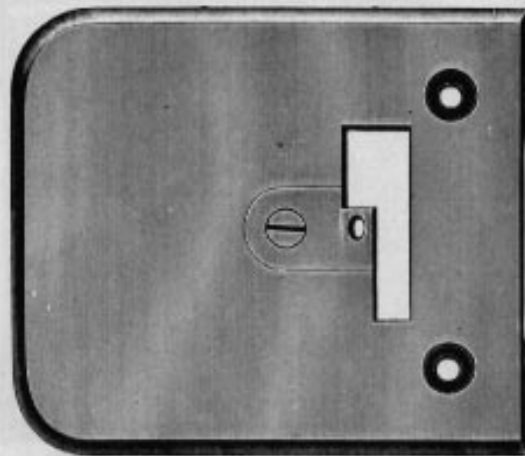


14518



PLATE 1832—FULL SIZE

12077



12079



12073



12071

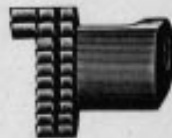
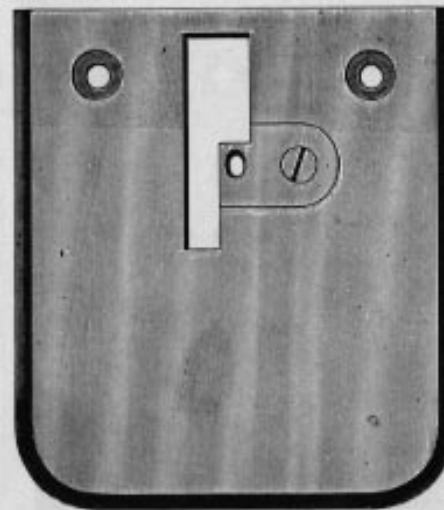


PLATE 1833—FULL SIZE

12054



12051



12052



12055





PLATE 1834—FULL SIZE

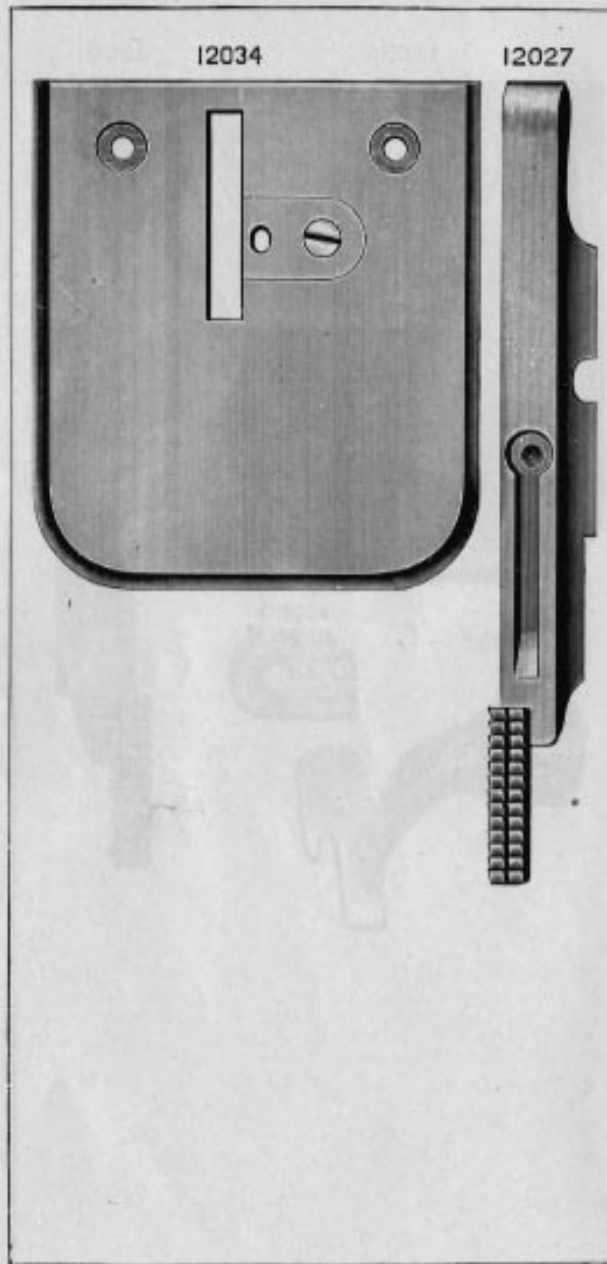


PLATE 1835—FULL SIZE

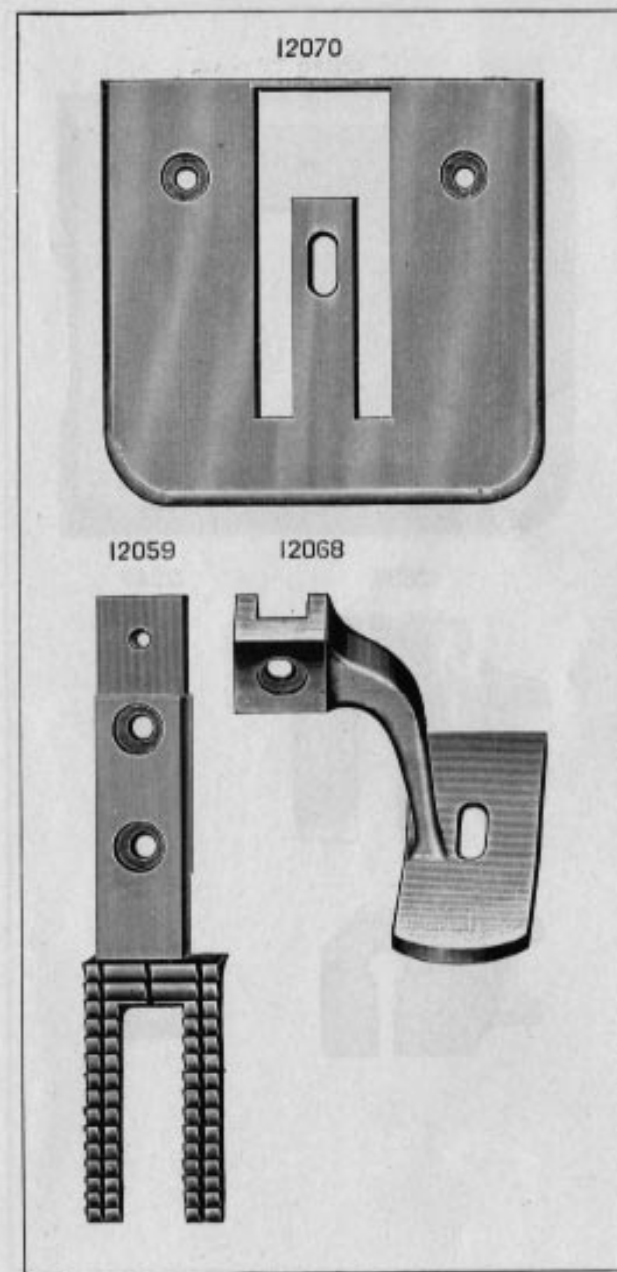
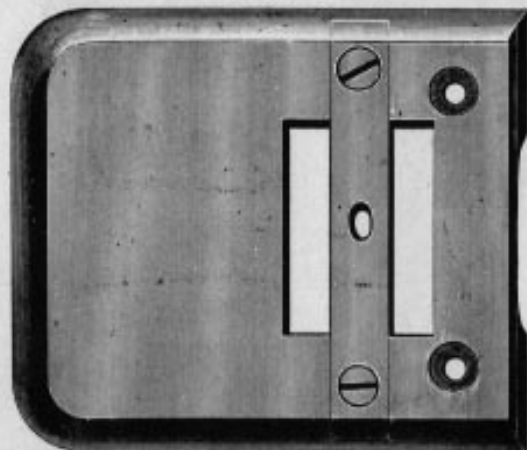
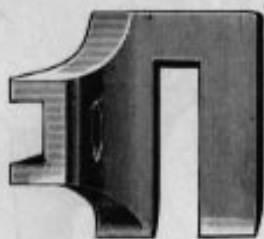


PLATE 1836—FULL SIZE

12046



12099



12047



11473



PLATE 1837—FULL SIZE

14519

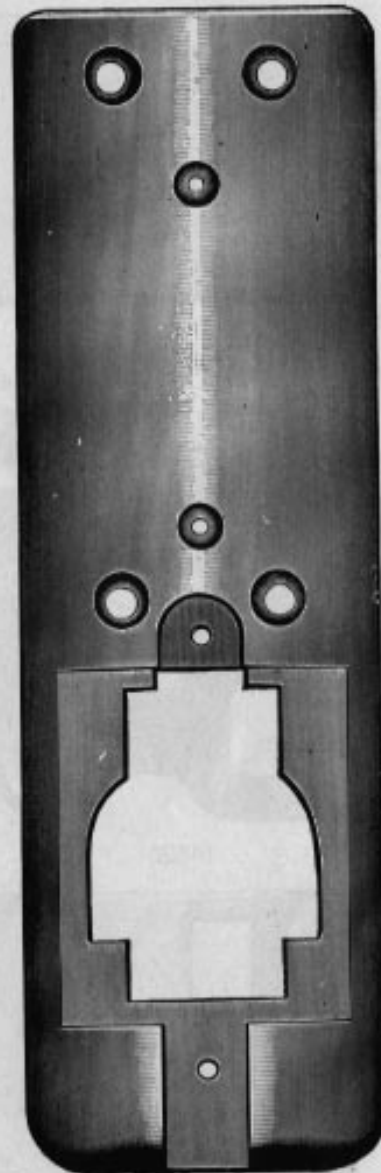




PLATE 1838—FULL SIZE

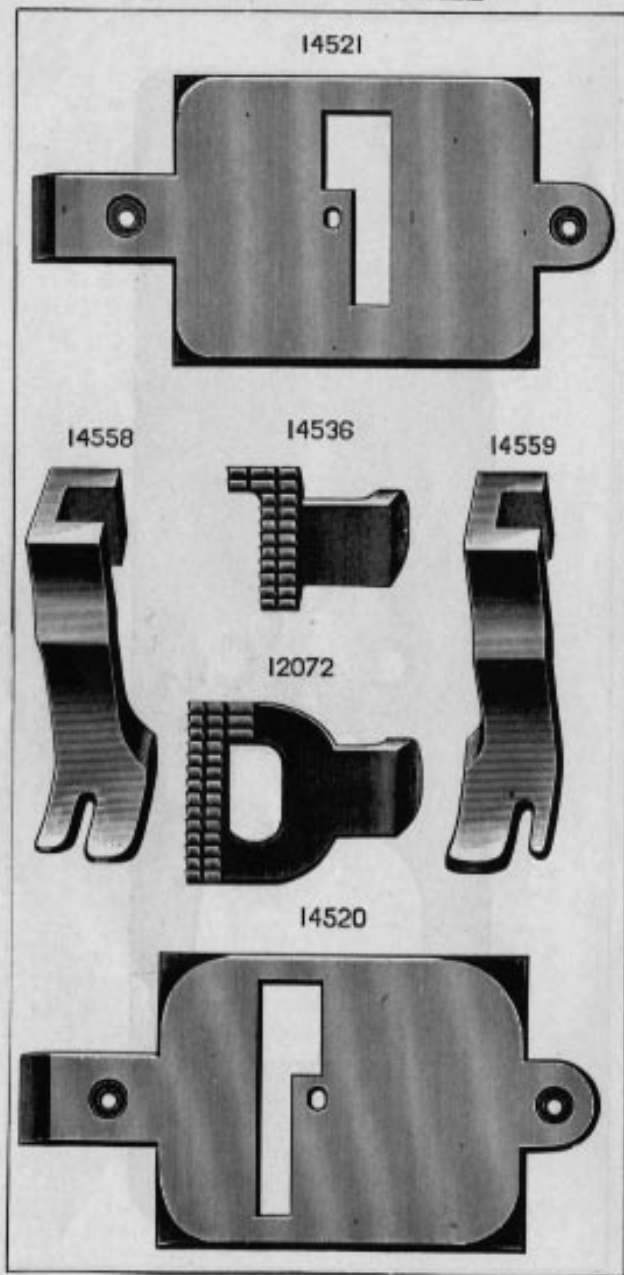


PLATE 1839—FULL SIZE

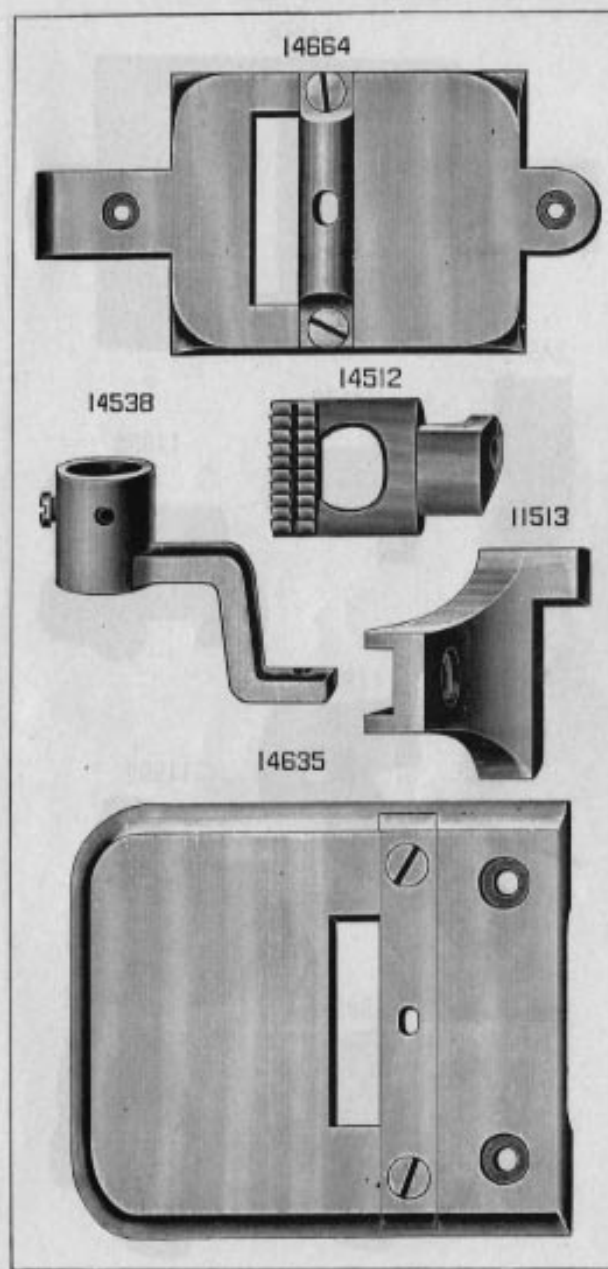


PLATE 1840—FULL SIZE

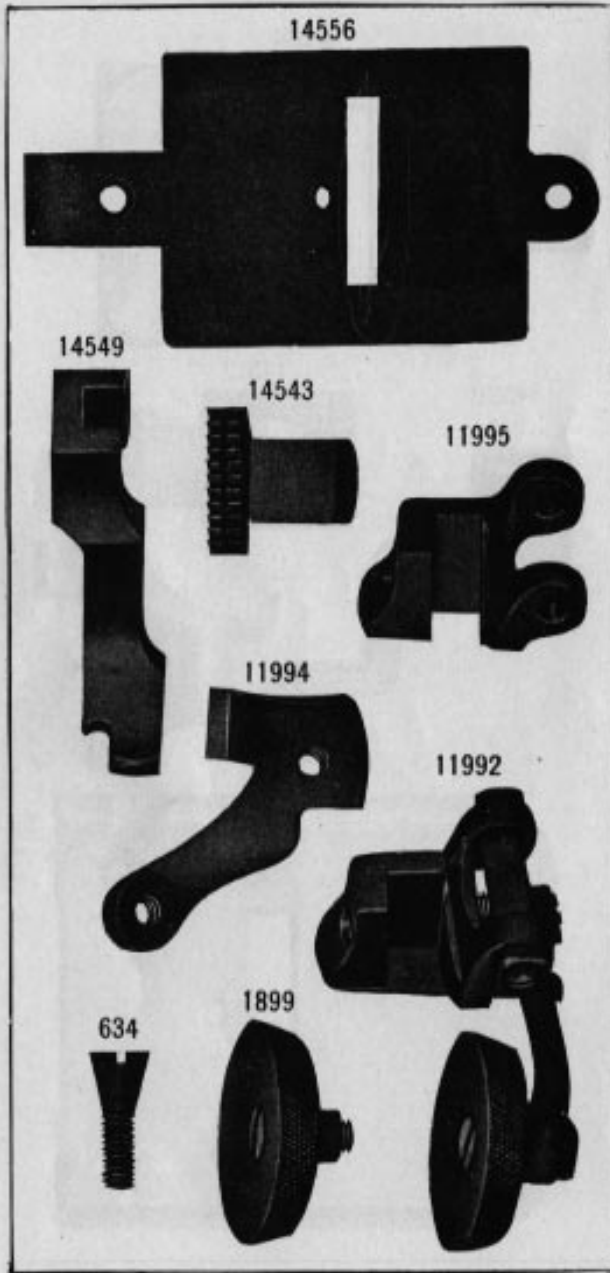


PLATE 1841—FULL SIZE

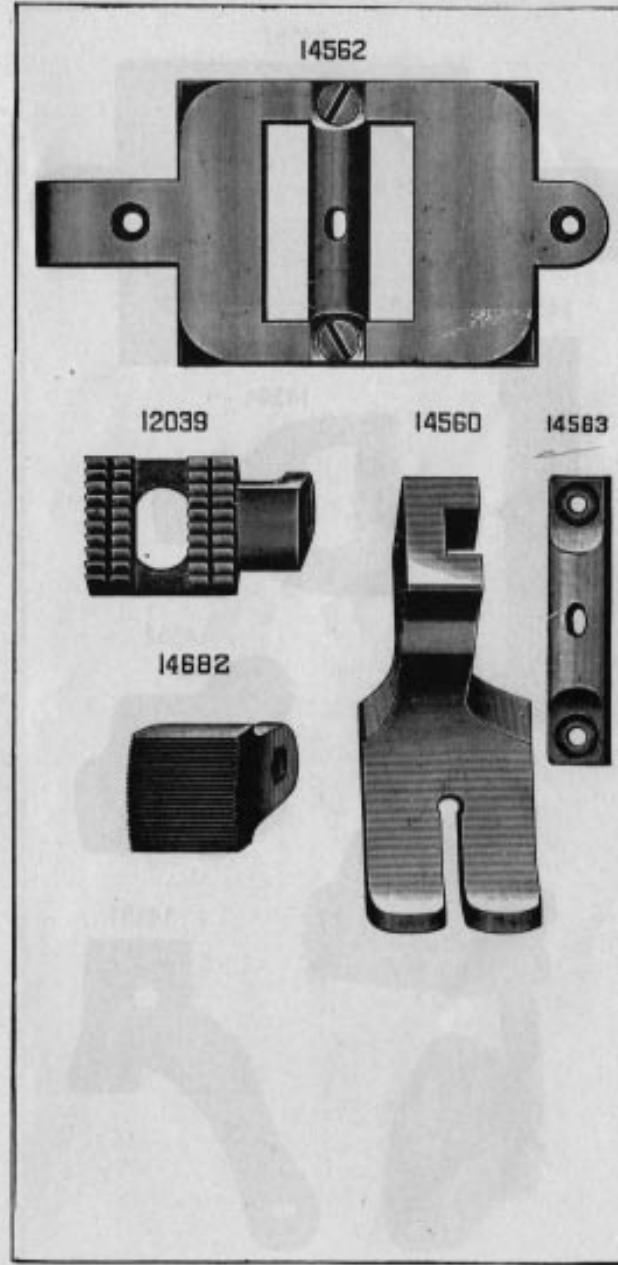


PLATE 1842—FULL SIZE

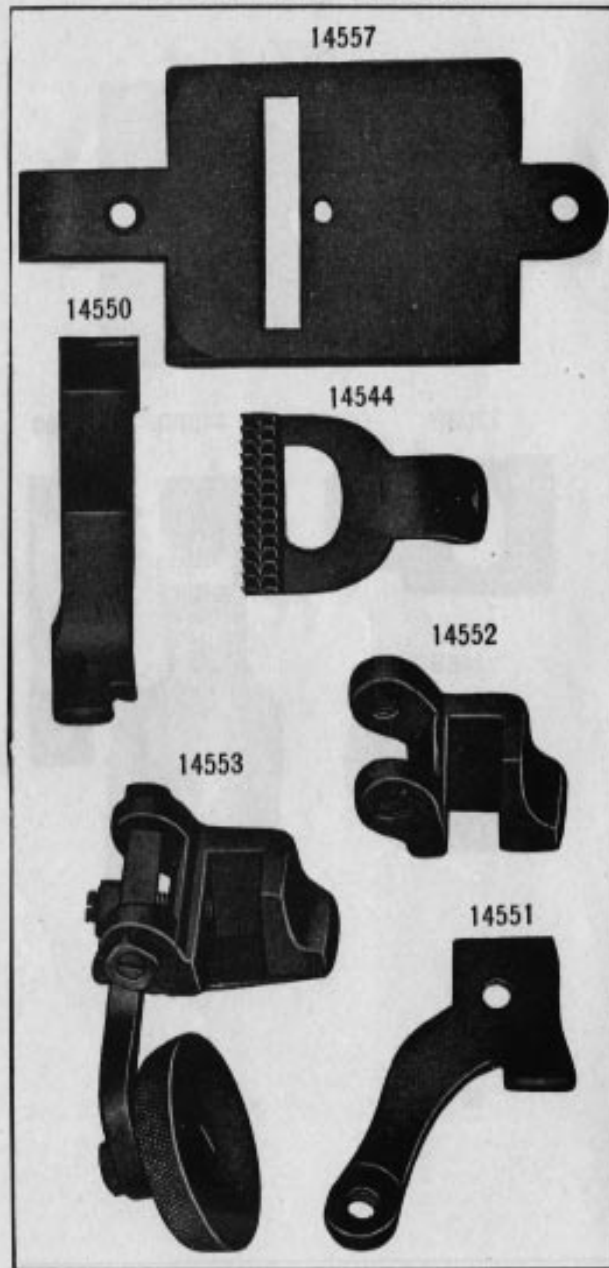


PLATE 1843—FULL SIZE

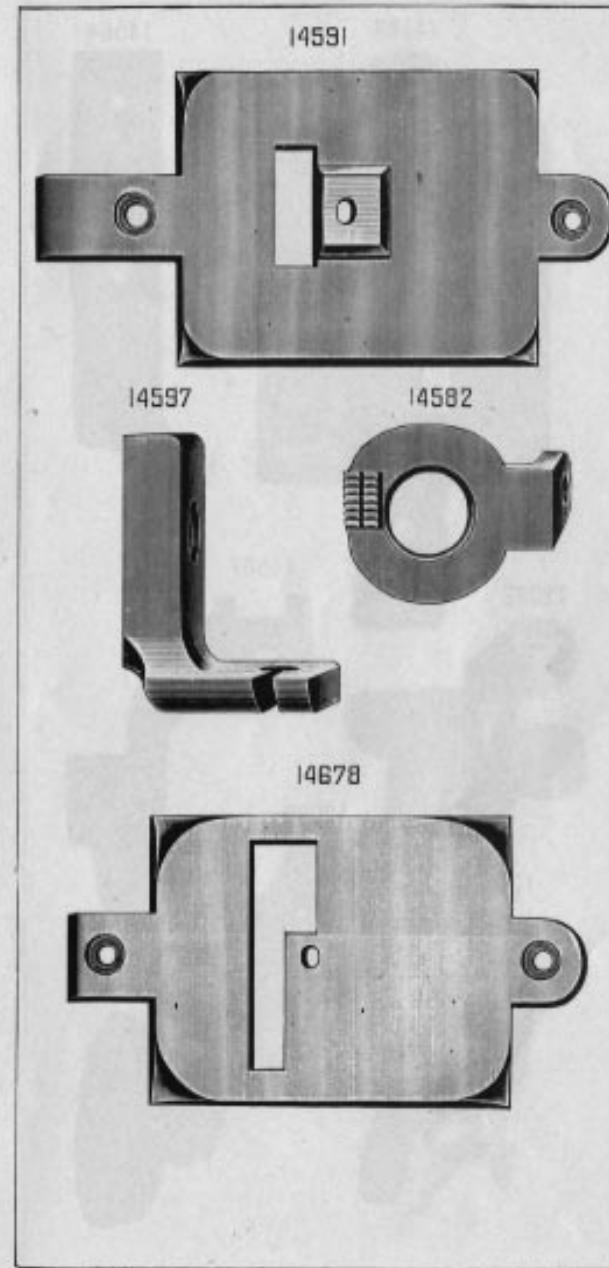


PLATE 1844—FULL SIZE

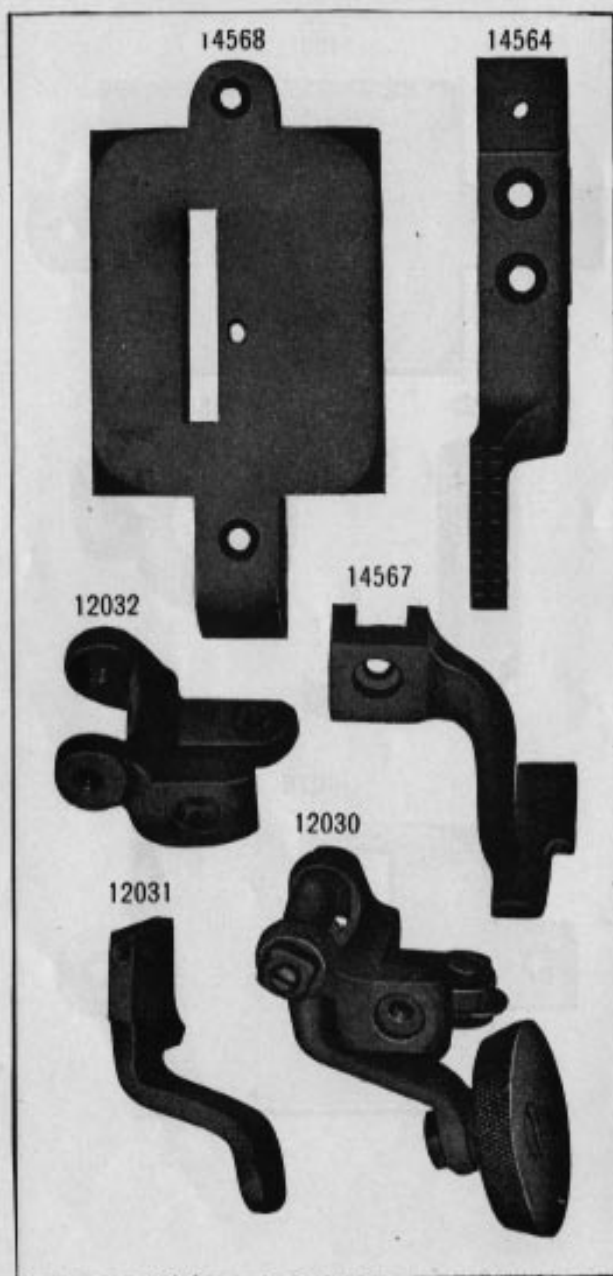


PLATE 1845—FULL SIZE

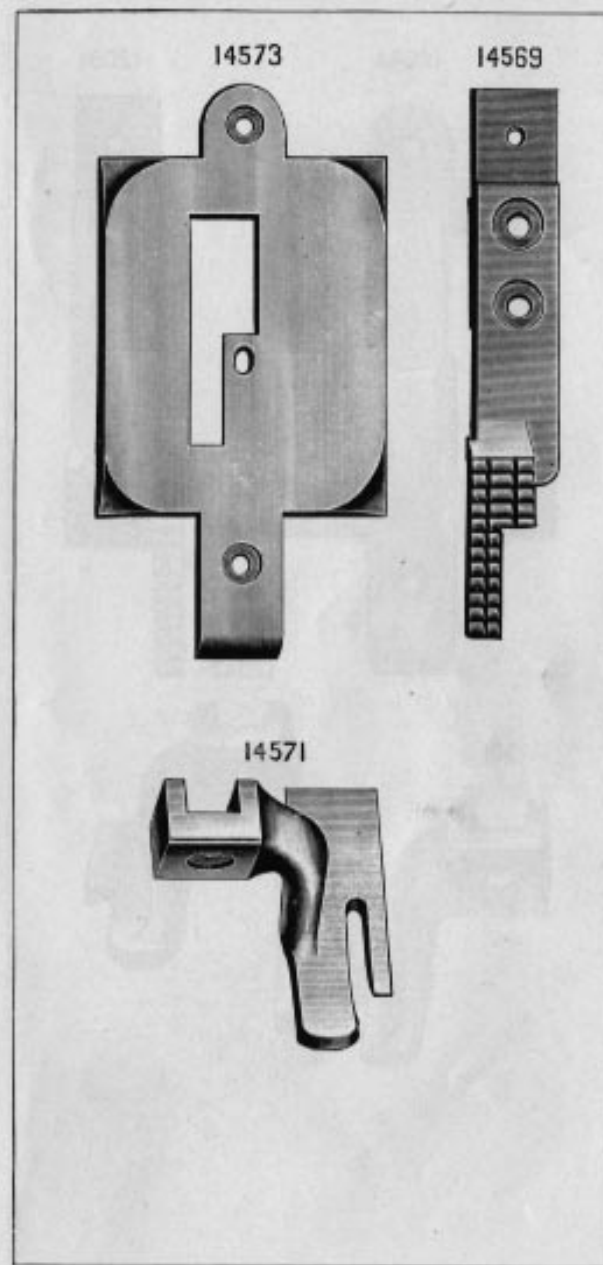


PLATE 1846—FULL SIZE

12084



12081



12082

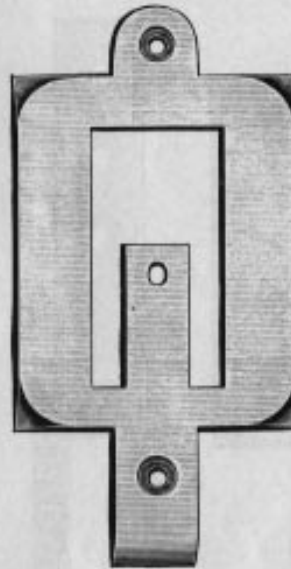


12083

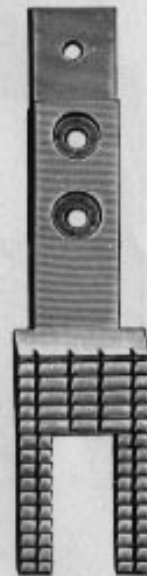


PLATE 1847—FULL SIZE

14574



14570



14572

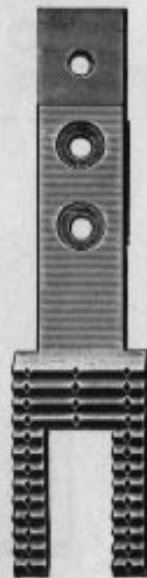


PLATE 1848—FULL SIZE †

14641



14645



14650

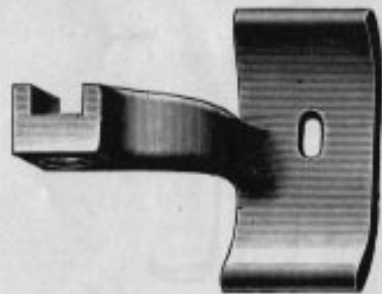


PLATE 1849—FULL SIZE

14677

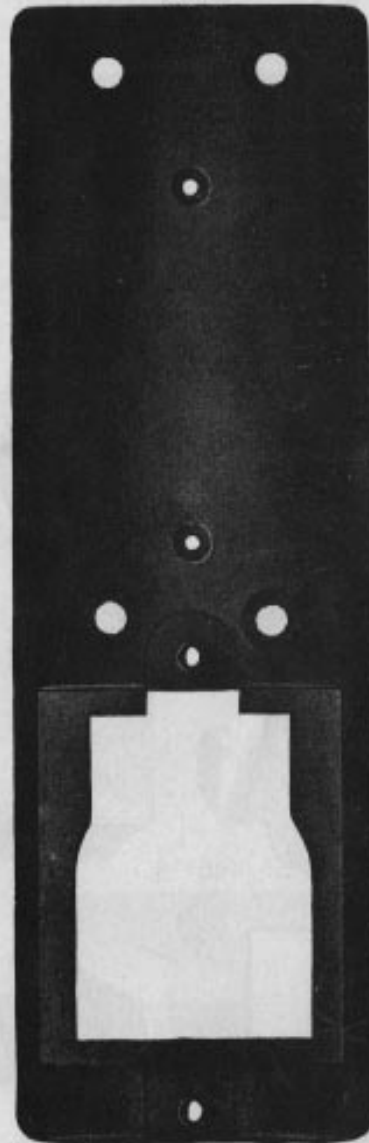




PLATE 1850—FULL SIZE

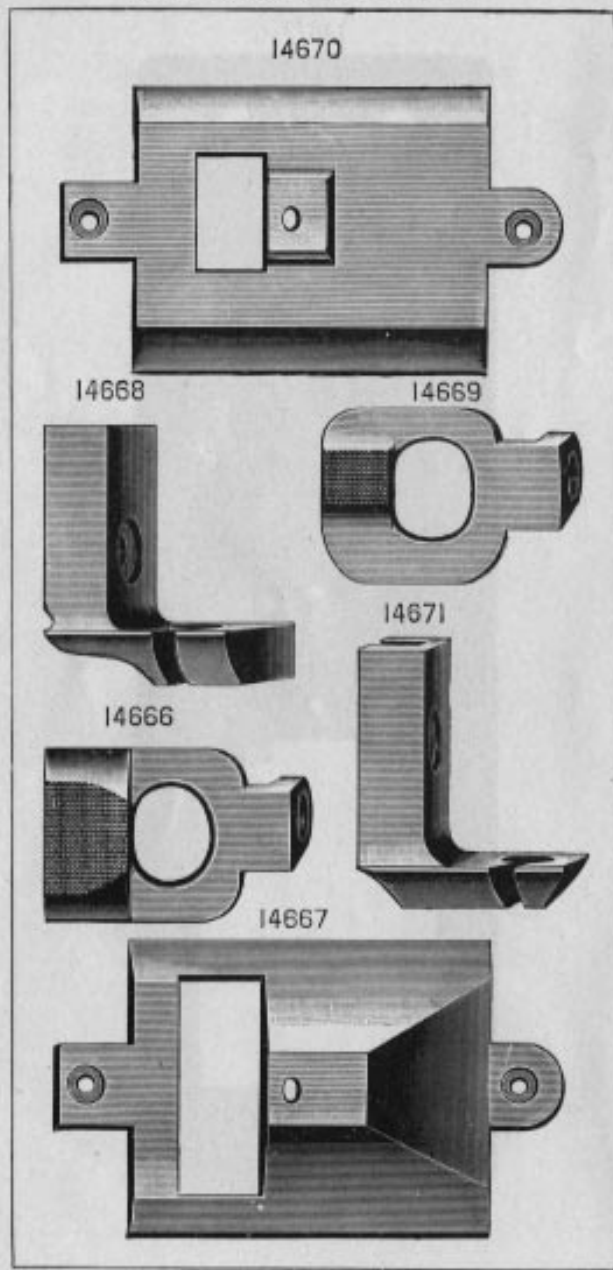


PLATE 1851—FULL SIZE

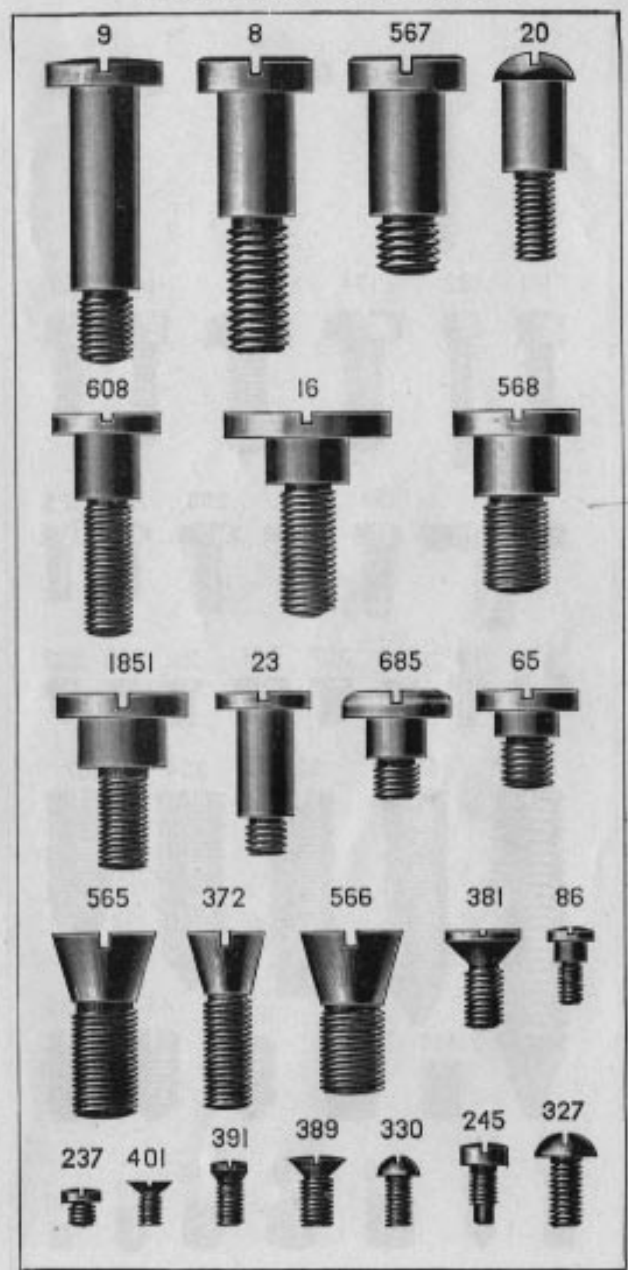


PLATE 1852—FULL SIZE

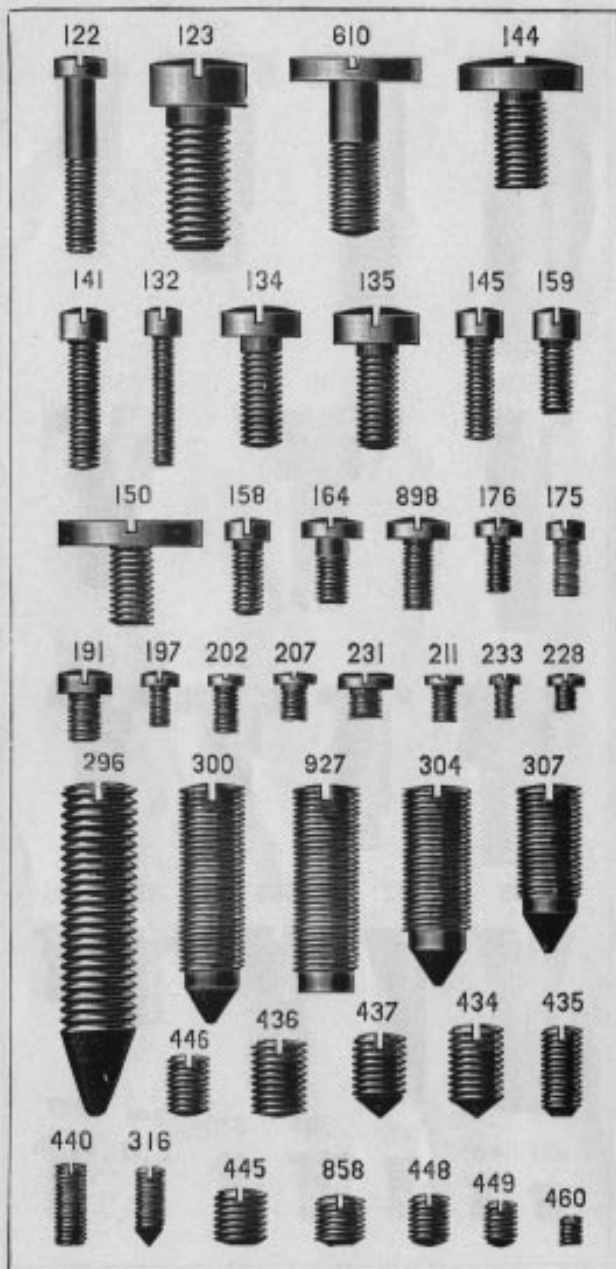


PLATE 1853—FULL SIZE

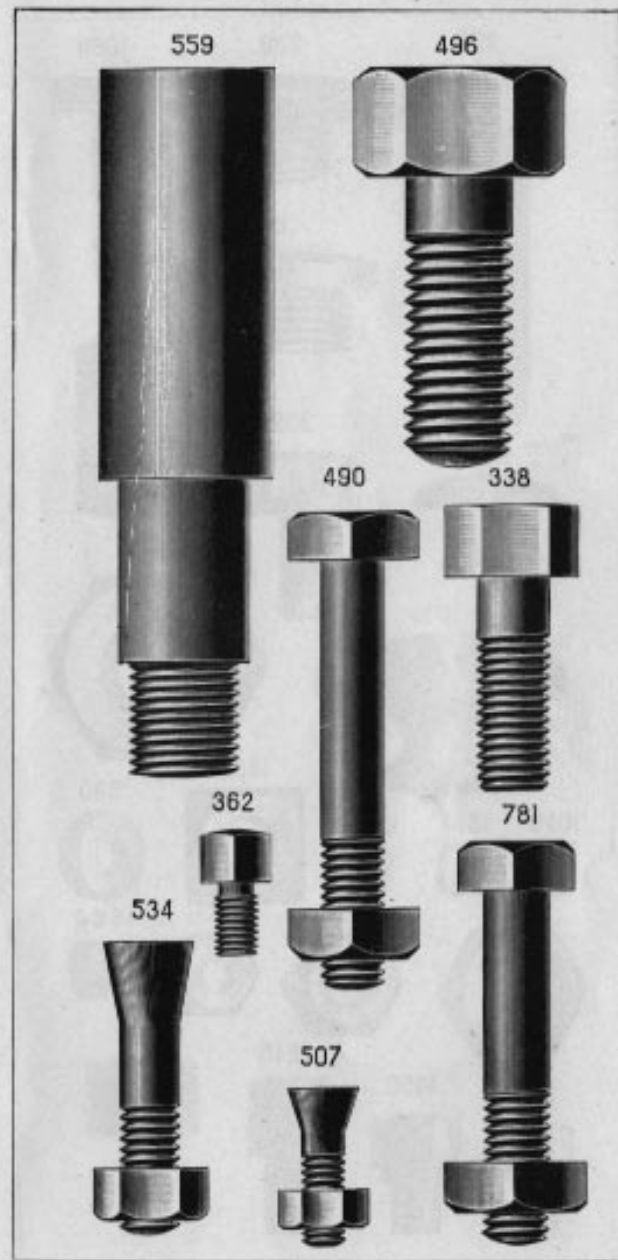




PLATE 1854—FULL SIZE

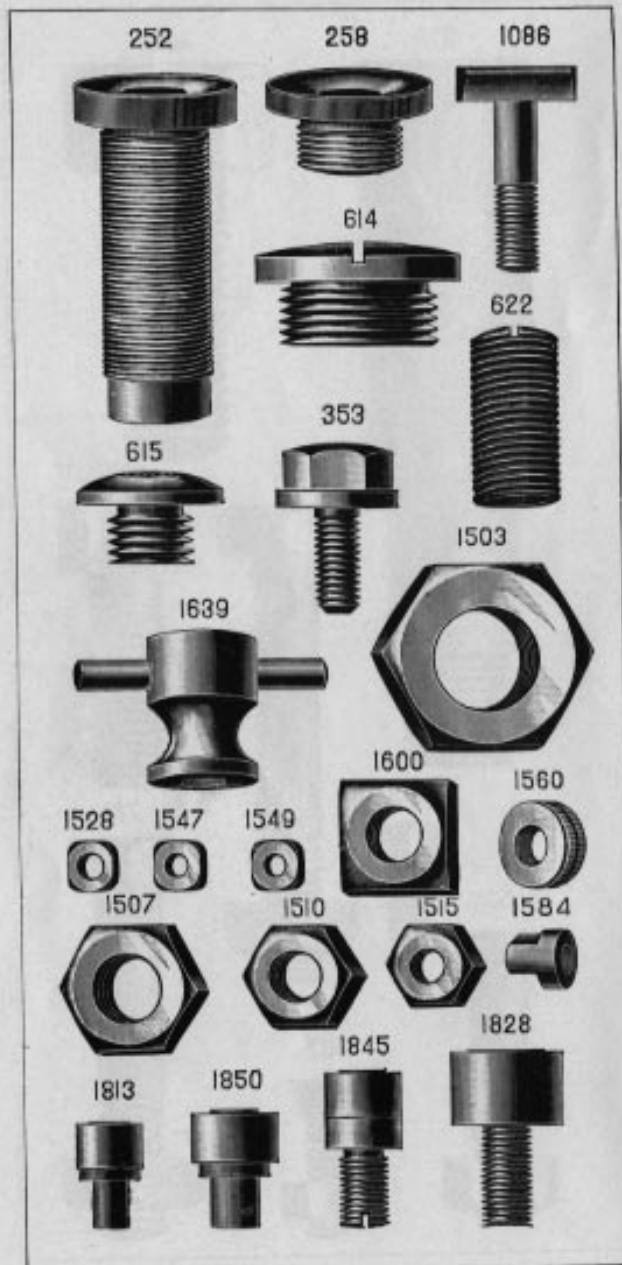


PLATE 1855—FULL SIZE

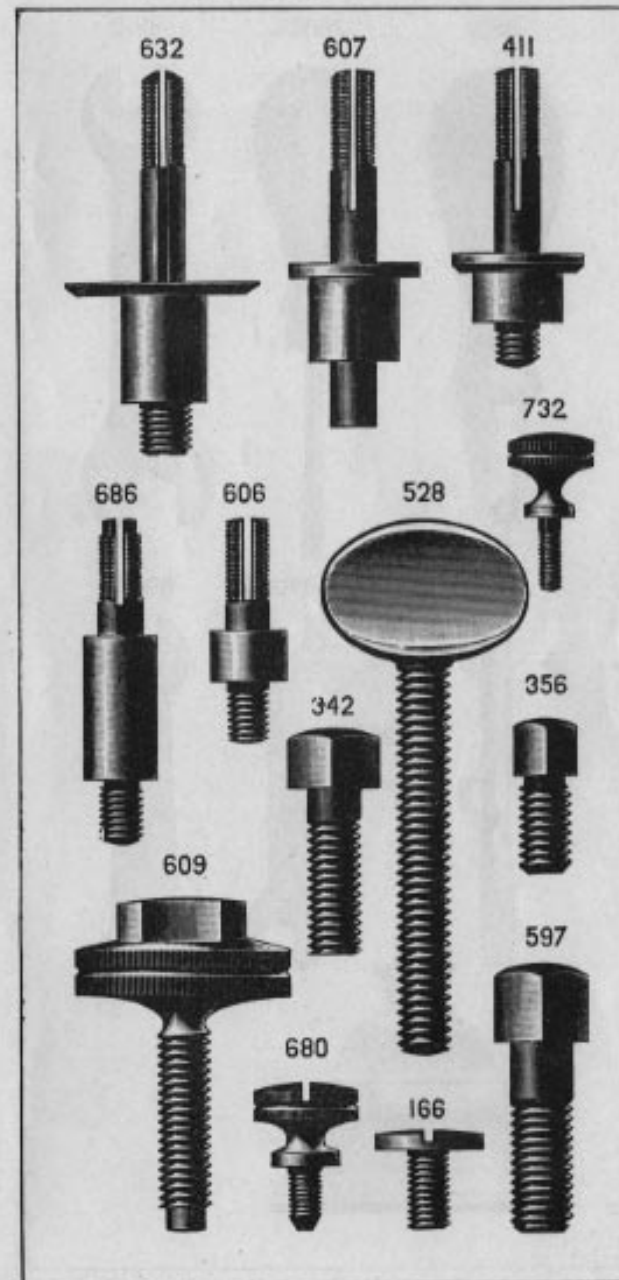


PLATE 1856—ONE-HALF SIZE

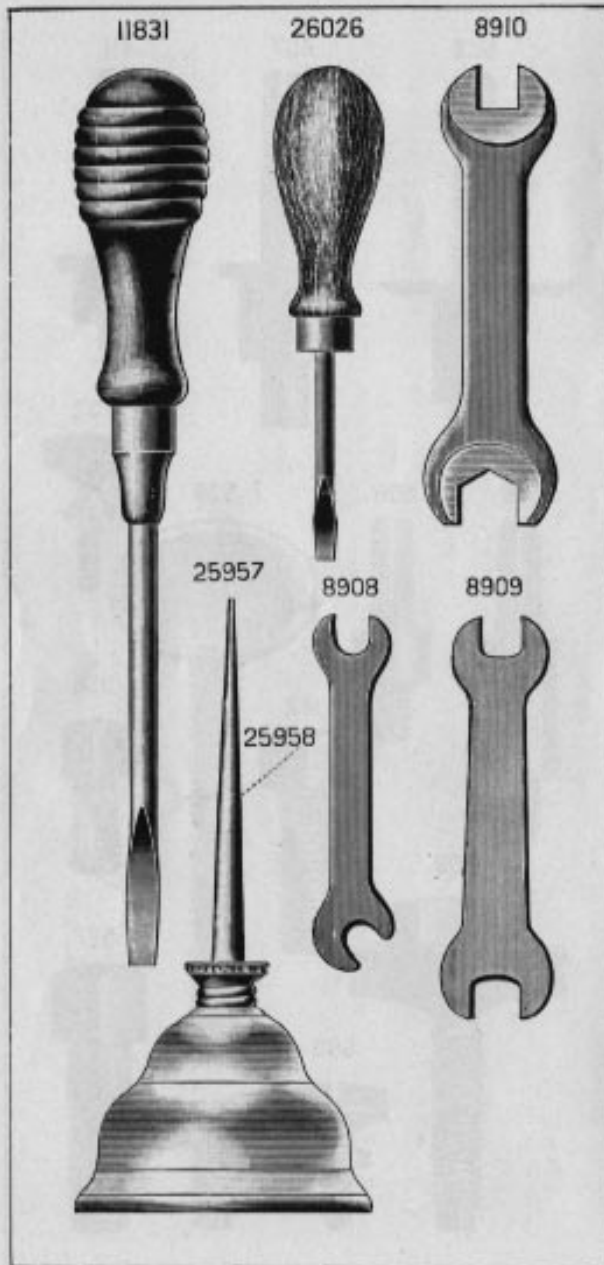
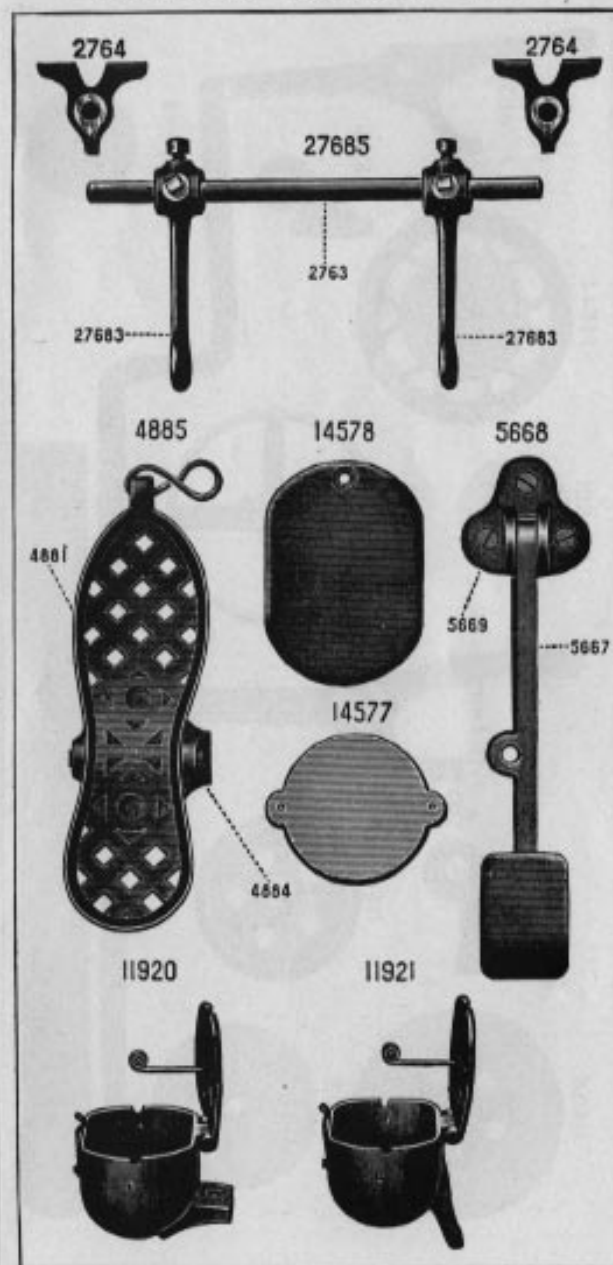


PLATE 1857—ONE-FOURTH SIZE



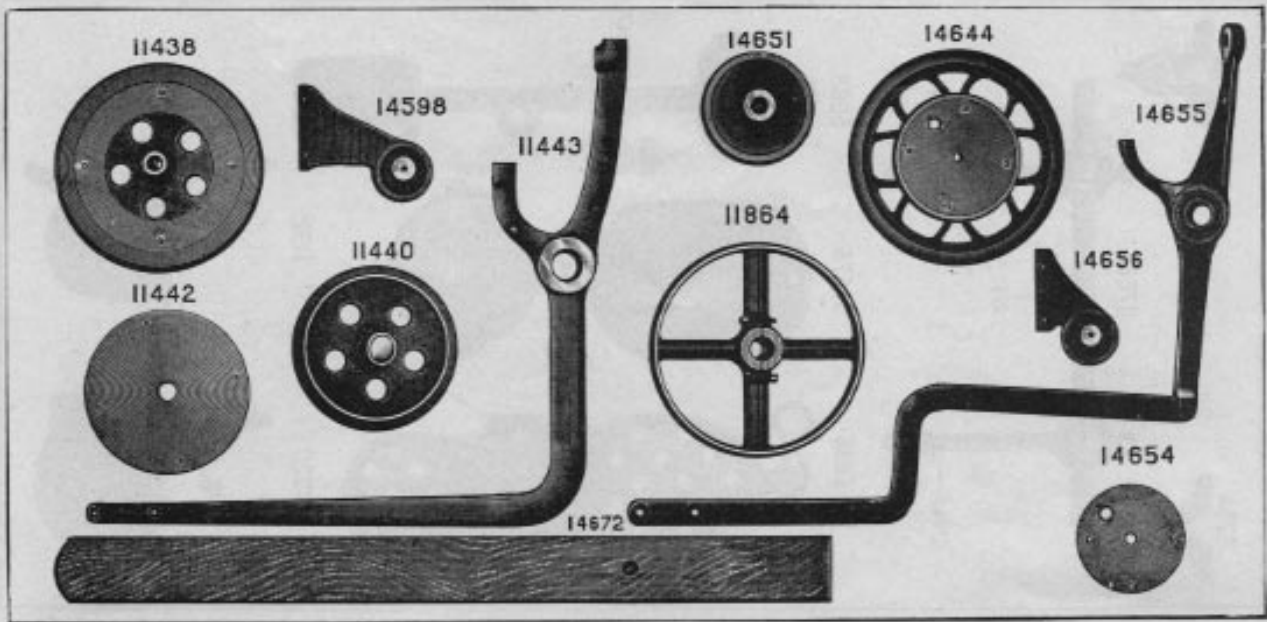


PLATE 1858—ONE-EIGHTH SIZE

PLATE 1859—ONE-FOURTH SIZE



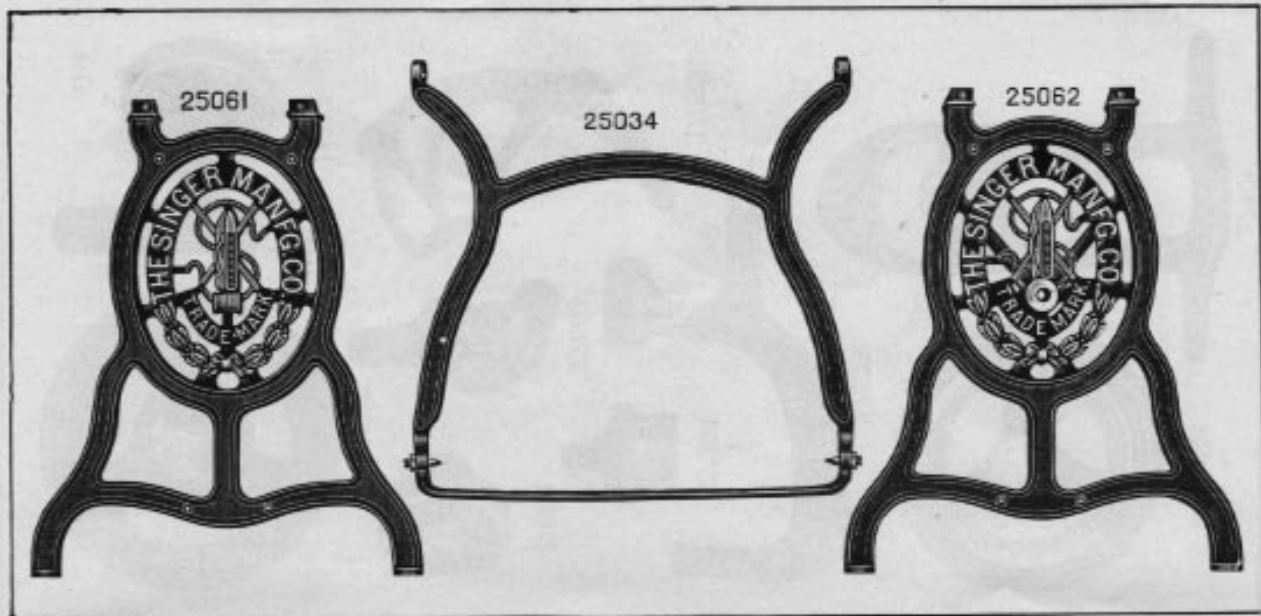


PLATE 1860—ONE-NINTH SIZE

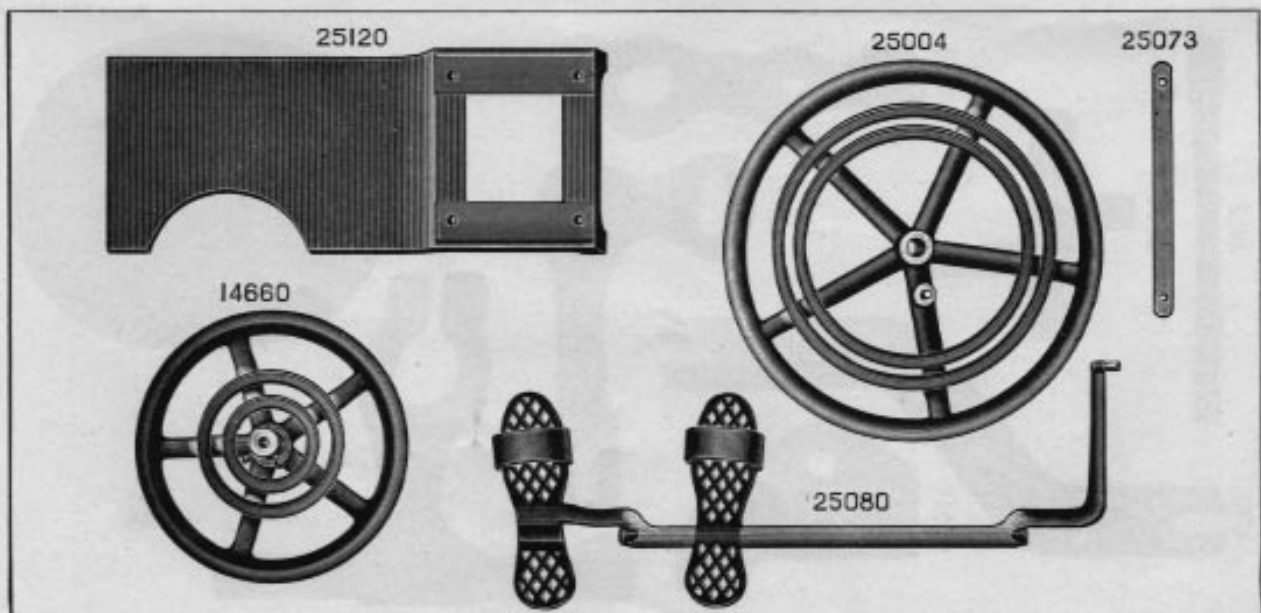


PLATE 1861—ONE-NINTH SIZE

PLATE 1862—ONE-HALF SIZE

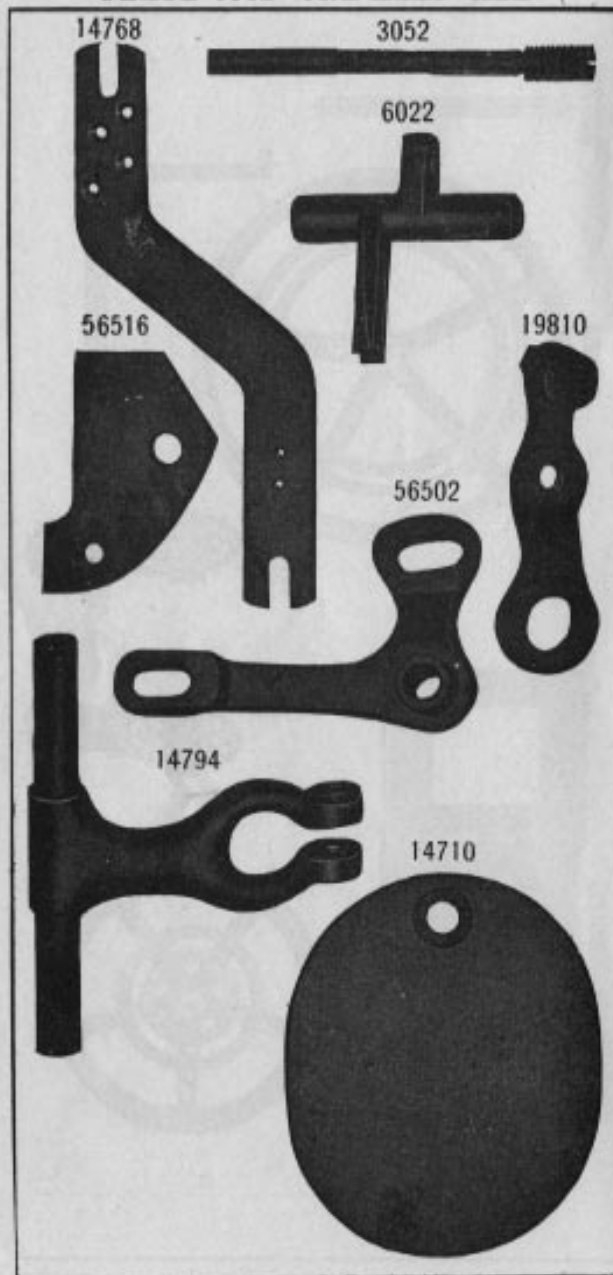


PLATE 1863—FULL SIZE

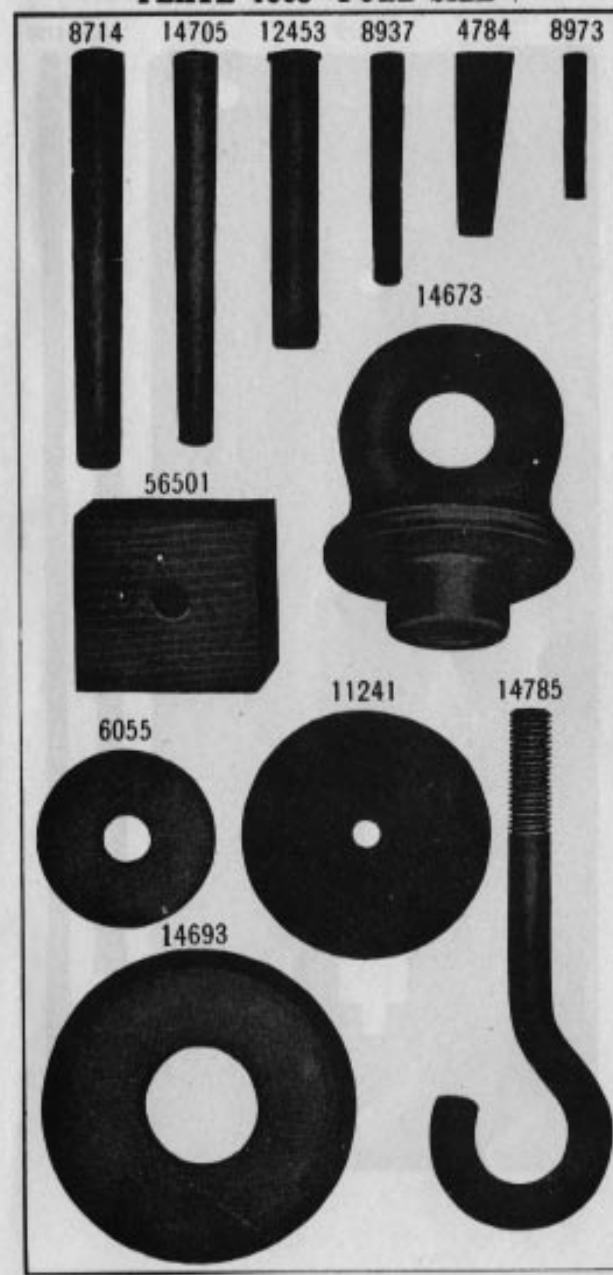




PLATE 1864—ONE-FOURTH SIZE

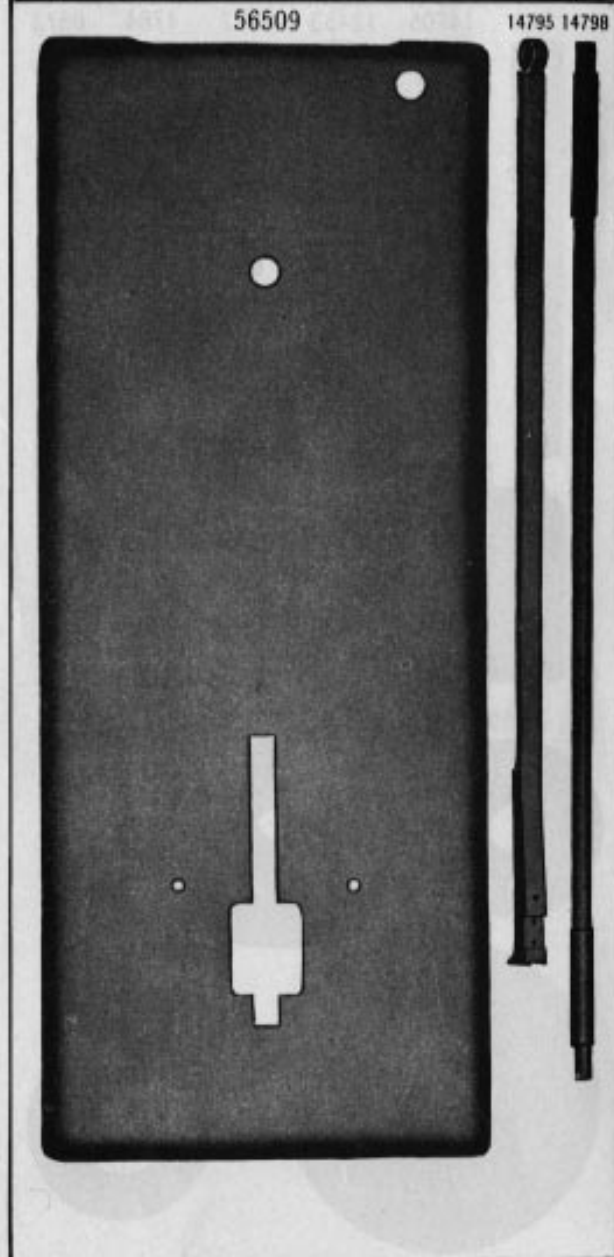


PLATE 1865—ONE-FOURTH SIZE

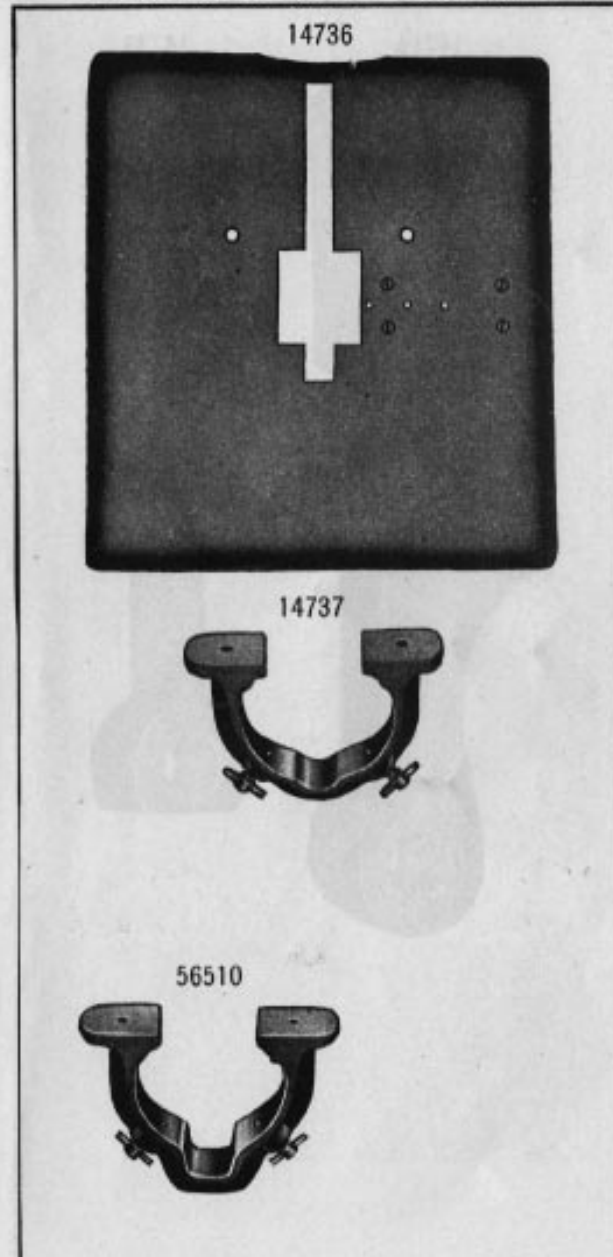


PLATE 1866—FULL SIZE

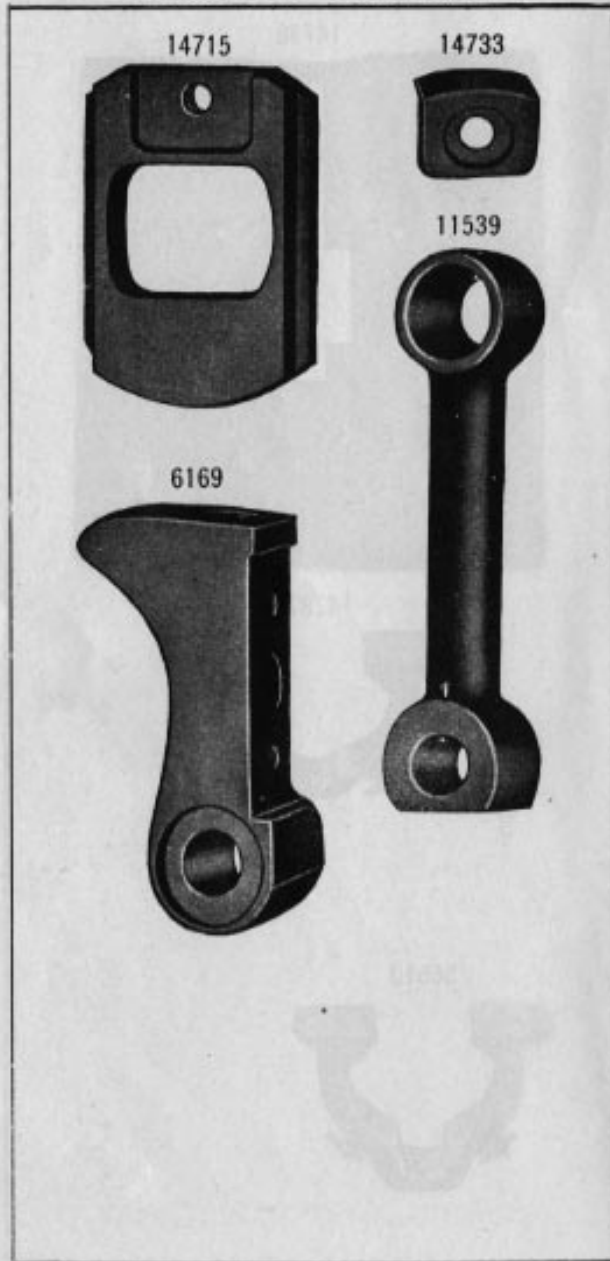


PLATE 1867—ONE-NINTH SIZE

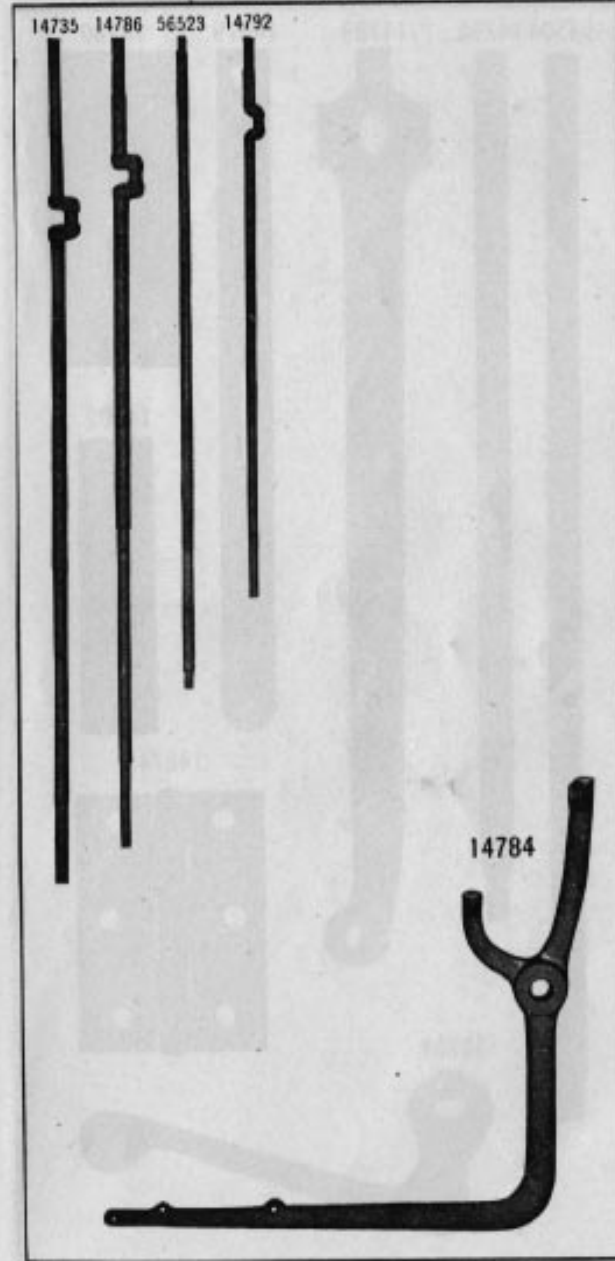




PLATE 1868—ONE-HALF SIZE

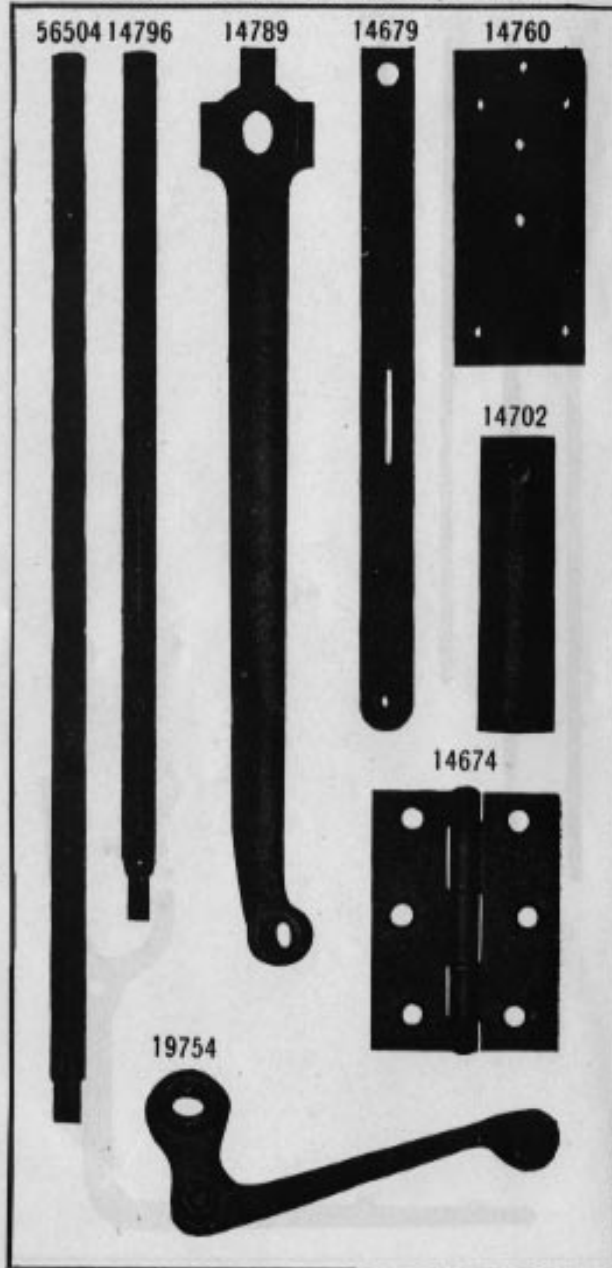


PLATE 1869—FULL SIZE

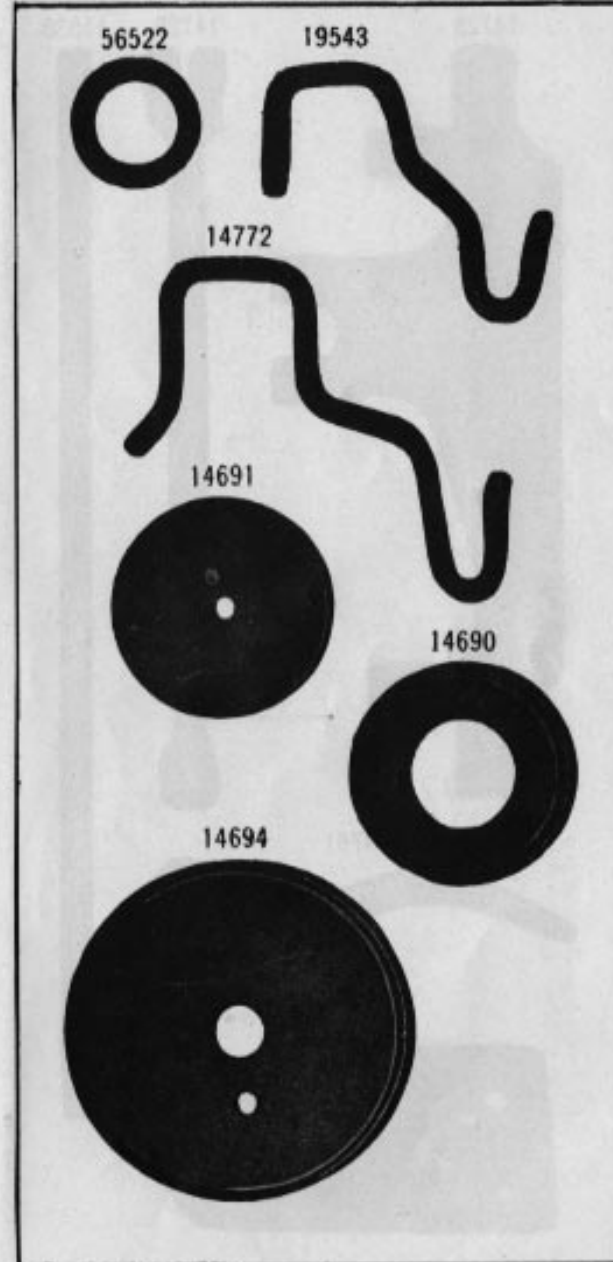


PLATE 1870—ONE-HALF SIZE

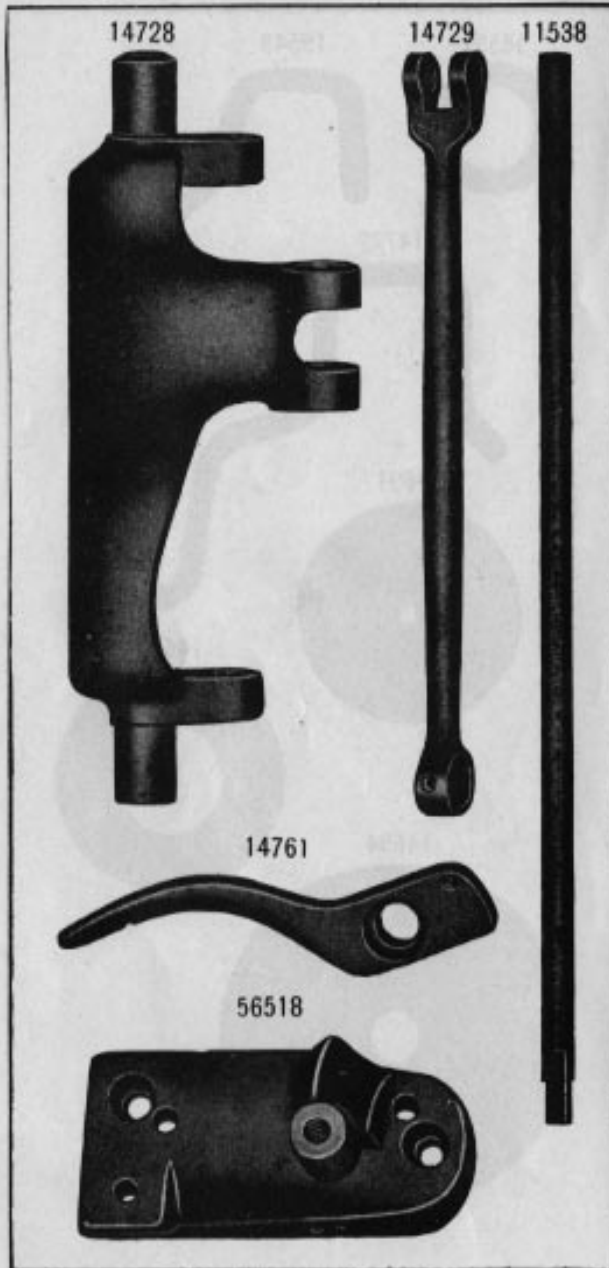


PLATE 1871—FULL SIZE

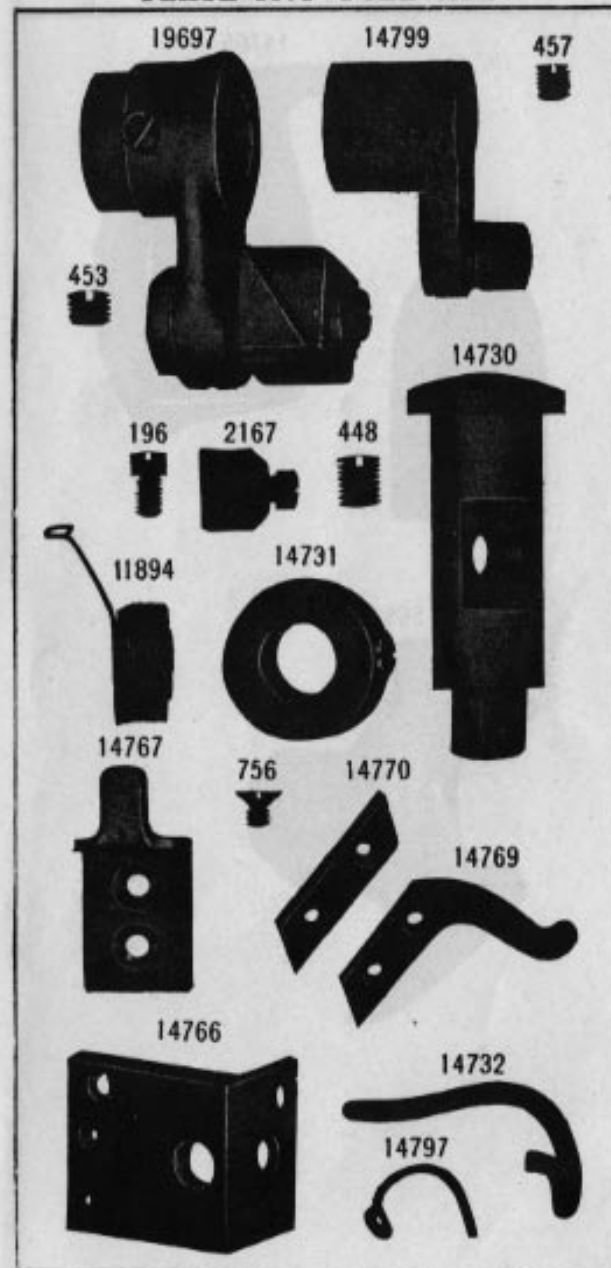


PLATE 1872—FULL SIZE



PLATE 1873—FULL SIZE

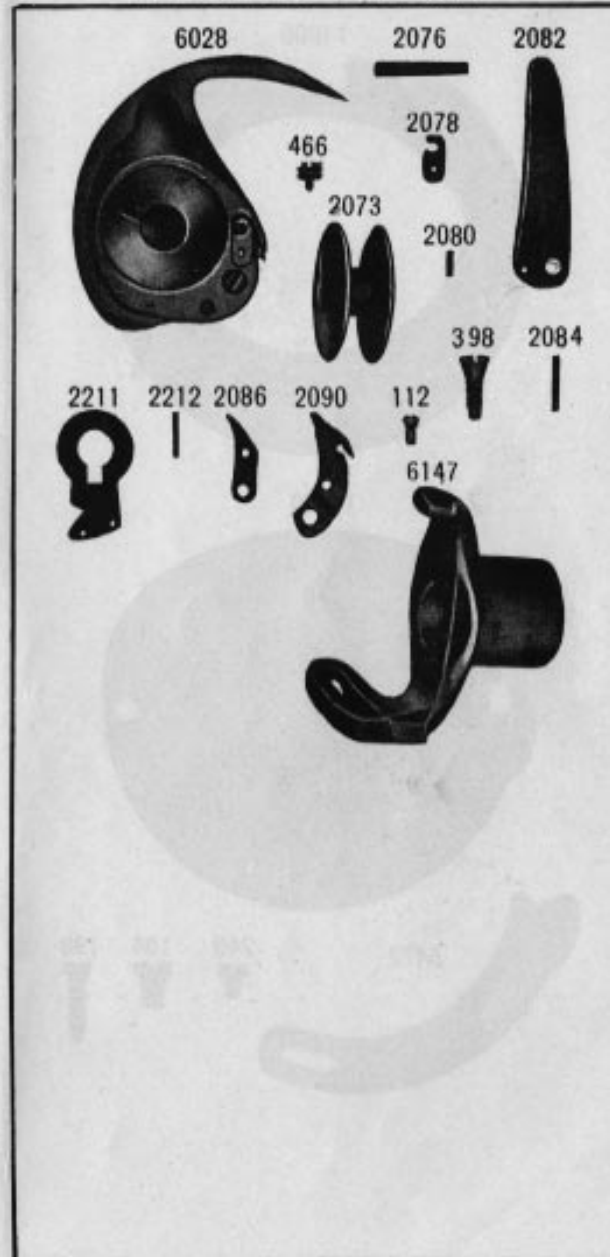
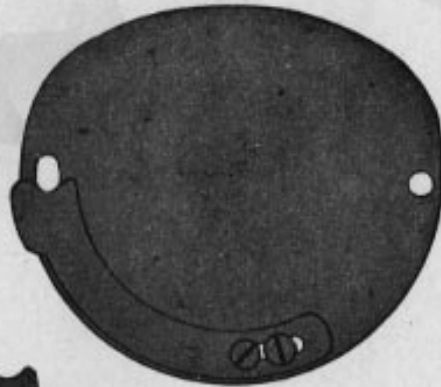


PLATE 1874—FULL SIZE

14800



16689



6472



240



104



198



PLATE 1875—FULL SIZE

14740



14741



14742



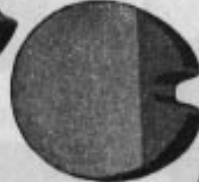
14743



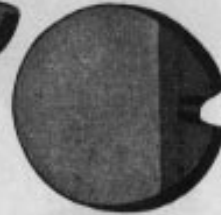
14744



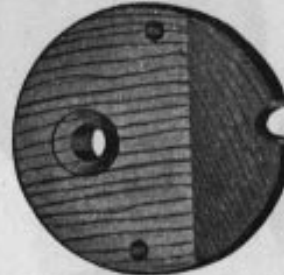
14745



14746



14747



14748



PLATE 1876—ONE-HALF SIZE

14754



14749



14750



14752



14755



14753



14756

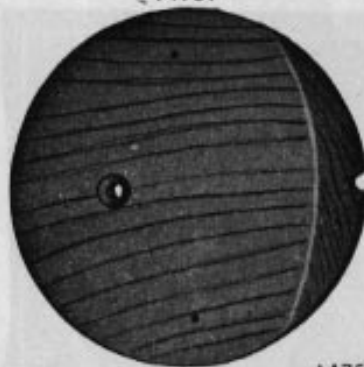


14751



PLATE 1877—ONE-HALF SIZE

14757



14758

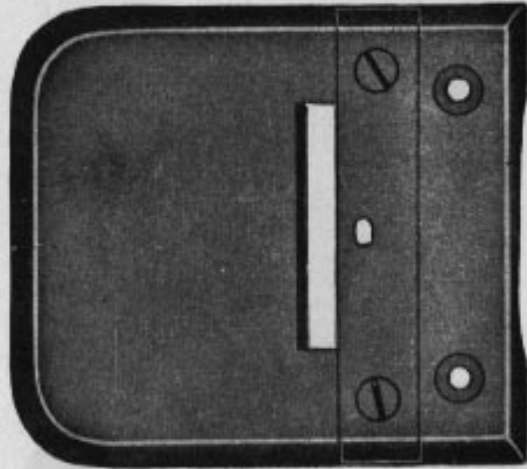


14759



PLATE 1878—FULL SIZE

14628

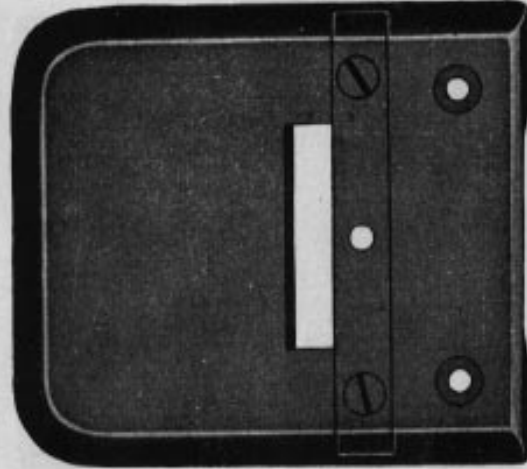


14627



PLATE 1879—FULL SIZE

14515



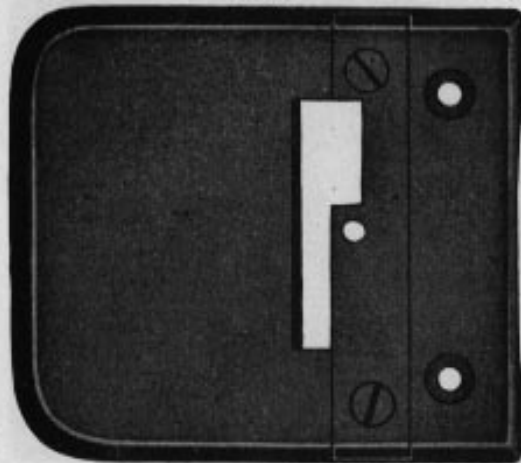
14514





PLATE 1880—FULL SIZE

12078



12080



PLATE 1881—FULL SIZE

14724



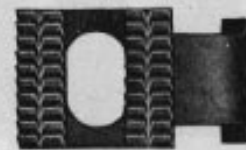
14716



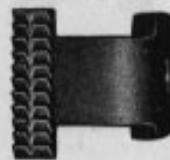
14721



14720



14723



14726



14722

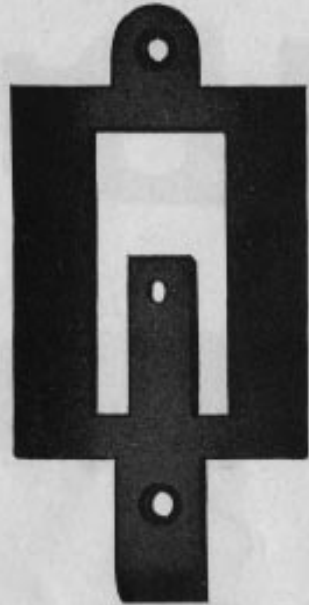


14725



PLATE 1882—FULL SIZE

14681



14570

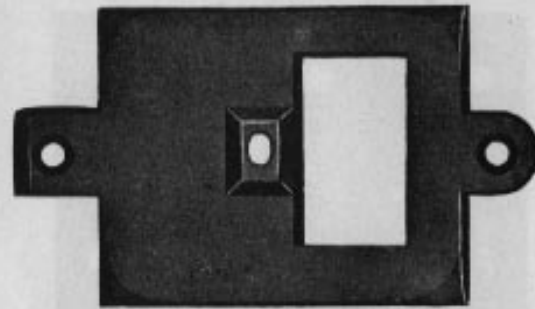


14680

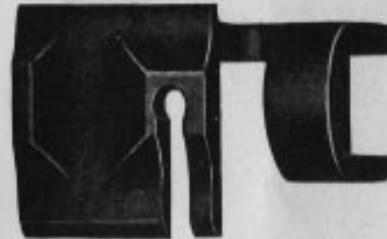


PLATE 1883—FULL SIZE

14684



56507



14727



56505



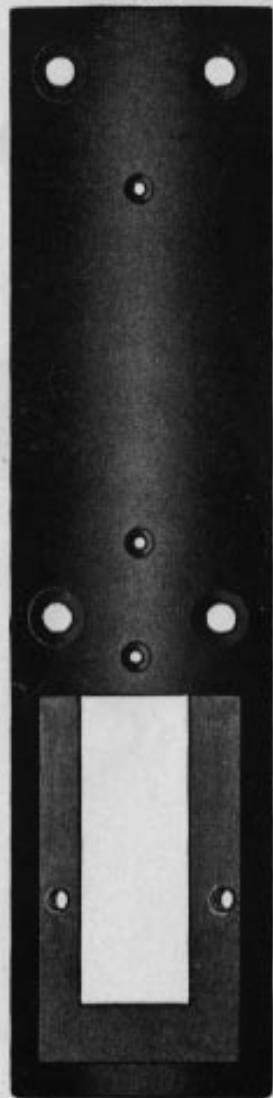
56506





PLATE 1884—FULL SIZE

14713



14711



14712

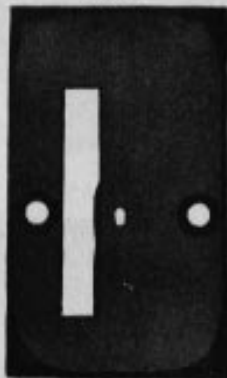
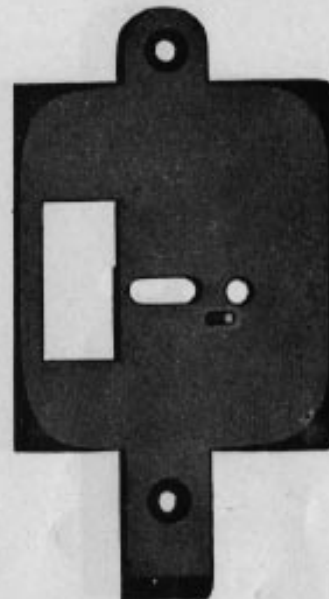


PLATE 1885—FULL SIZE

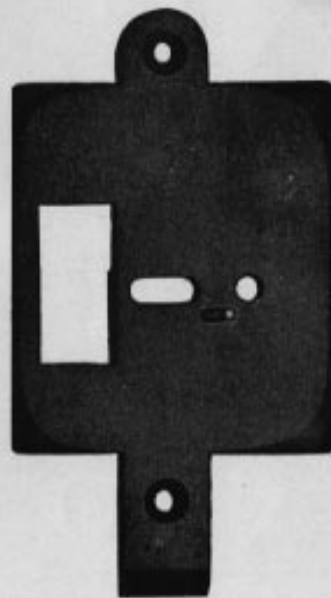
14739



14773



14775



14026



PLATE 1886—FULL SIZE

14782



846



PLATE 1887—FULL SIZE

56517



14763



14683



14762



PLATE 1888—FULL SIZE

14783

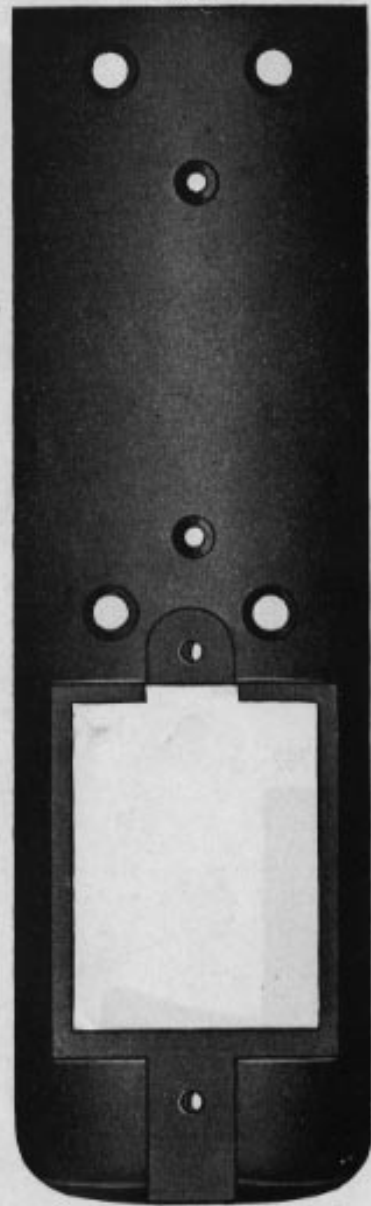


PLATE 1889—FULL SIZE



PLATE 1890—ONE-HALF SIZE

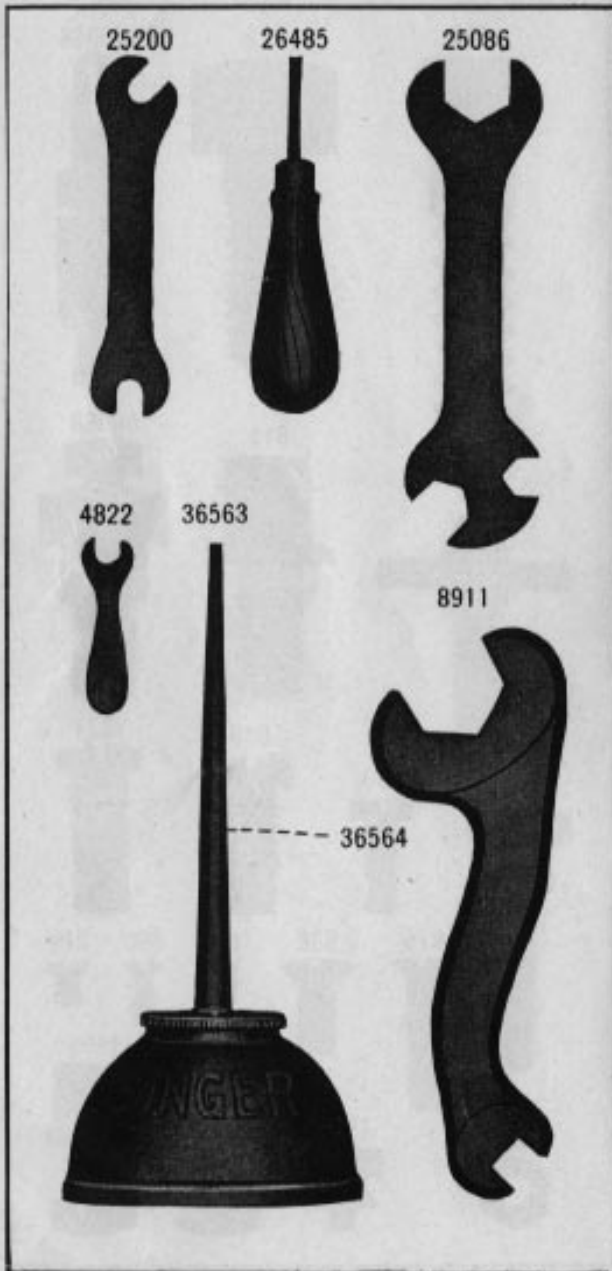


PLATE 1891—FULL SIZE

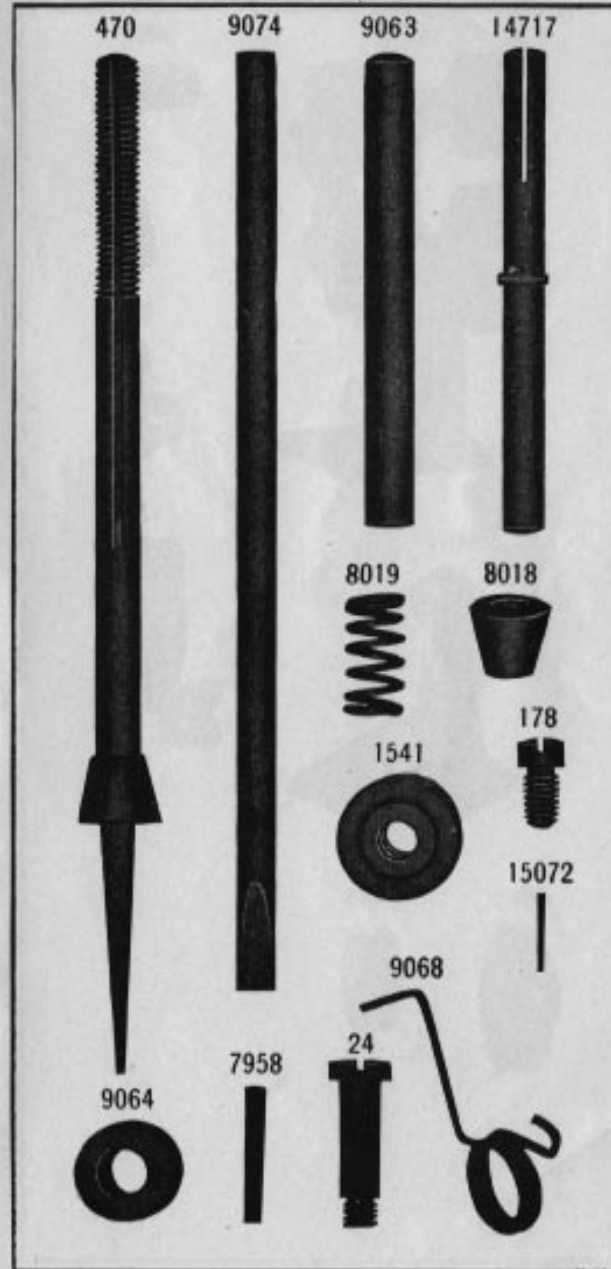


PLATE 1892—ONE-HALF SIZE

14719



9067



9070



14718



9062



9065



2448



