

Singer 11-32

Singer 11-34

Singer 11-35

Form 18992
(886)
PRINTED IN U. S. A.

LIST
OF
PARTS



MACHINES
Nos. 11-32, 11-34 and 11-35

THE SINGER MANUFACTURING COMPANY

INSTRUCTIONS FOR OILING

To ensure easy running and prevent unnecessary wear of parts which are in movable contact, the machine should be oiled at least twice a day in continuous use. Apply a drop of oil to the shuttle bearing in the shuttle race each time a bobbin is replaced.

Copyright, U. S. A., 1918 and 1936, by
The Singer Manufacturing Co.
All Rights Reserved for all Countries

INDEX

	Page
Accessories.....	27
Bobbin Winder for 11-32 Machine.....	27
Bobbin Winder for 11-34 and 11-35 Machines.....	28
Bobbin Winder and Thread Unwinder Parts for 11-32 and 11-34 Machines.....	29
Bobbin Winder and Thread Unwinder Parts for 11-35 Ma- chine.....	30
Driving Attachment for 11-32 Machine.....	30
Driving Attachment for 11-34 Machine.....	33
Driving Attachment for 11-35 Machine.....	33
Machine No. 11-32.....	5
Machine No. 11-34.....	14
Machine No. 11-35.....	21
Foot Lifter Parts for 11-34 Machine.....	33
Numerical List of Parts.....	35

INSTRUCTIONS FOR ORDERING

In ordering from this list, use **ONLY** the part NUMBER in the **FIRST** column.

The number stamped on a Sewing Machine Part is in every case the number of the single part only.

Every combination of parts sent out as such has its specific number, which, although not stamped on the parts, must be used when ordering the combination.

Each number always indicates the **SAME PART** in whatever list it appears, or for whatever machine.

The letters after some of the numbers indicate the style of finish only, as follows:

- A-Hardened, Polished, Nickel Plated and Buffed
- B-Polished, Nickel Plated and Buffed
- C-Hardened Only
- D-Polished Only
- E-Soft, Not Polished
- F-Hardened and Polished

F, J-Hardened, Polished and Nickel Plated

G-Bright Rumbled and Nickel Plated

H-Blued

J-Nickel Plated Only

K-Hardened and Nickel Plated

L-Brass Plated

M-Oxidized

N-Japanned, Dull

P-Japanned, Bright

R-Merlized

T-Copper Plated

T, A-Hardened, Polished, Copper and Nickel Plated and Buffed

T, B-Copper and Nickel Plated and Polished

T, J-Copper and Nickel Plated Only

T, K-Hardened, Copper and Nickel Plated

T, M-Copper Plated and Oxidized

T, L-Copper and Brass Plated

U-Zinc Plated

V-Silver Plated

W-Polished and Nickel Plated

Y-Black Nickel Plated Only

Z-Chromium Plated

Z, B-Polished, Nickel Plated, Buffed and Chromium Plated

Z, J-Nickel and Chromium Plated

These letters **MUST BE USED** when they appear in the list; and **AFTER** the number as in the list.

In this series:

1 to 1500, 50001 to 51500 and 140001 to 142000 are Screw Numbers

1501 to 1800 and 51501 to 51800 are Nut Numbers

1801 to 2000 and 51901 to 52000 are Roller Numbers

2001 to 50000 and 52001 to 140000 and 142001 to

190000 are Sewing Machine Parts, 190001 and upward

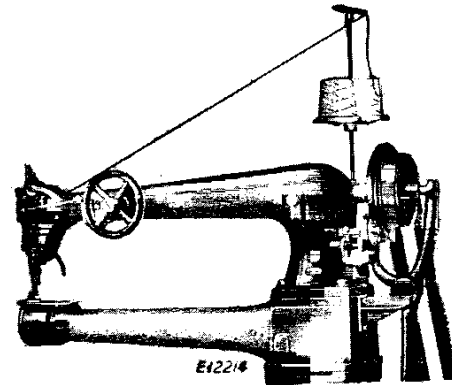
are numbers of Electrical Parts.

The figures in the second column refer only to the plates, illustrating the parts, and are **NOT TO BE USED** in ordering.

Parts marked with an asterisk (*) are furnished only when repairs are made at factory.

LIST OF PARTS COMPLETE

FOR



MACHINE No. 11-32

For Making or Covering Eyelets or Grommet holes, with or without metal rings, in Tarpaulins, Sails, Tents, Mail Bags, Etc. Clearance under arm 30 inches from the needle to the base of the arm. Drop feed. S. D. A. Regularly furnished for holes 1/2 in., 3/8 in., 3/4 in. and 7/8 in. diameter, but if so ordered the machine will be fitted to make holes 1 inch to 4 1/2 inches in diameter, the variations in size being not less than 1/4 inch. Pulley No. 11440, diameter 7 inches. Speed 300 R. P. M.

No.	Plate	Name
*122326	-----	Arm.....
122327	-----	" 122326 with 65D, 14578, 15404, 122328, two each 434C and 15405.....
19785	1894	Arm Dowel Pin.....
56715	22441	" Packing.....
50346E	22419	" Screw.....
43283	1894	" " Washer.....
122470	22442	" Shaft.....
11354	22419	" " Bushing.....
437C	1894	" " " Set Screw.....
56536	22419	" " " Gear with two 445C.....
3012	1894	" " " Pin.....
445C	1894	" " " Set Screw.....
144D	1894	" " " Screw.....
9842	1894	" " " Washer.....
14578	22434	" Side Cover.....
65D	1894	" " " Hinge Screw.....

PARTS FOR MACHINE NO. 11-32

No.	Plate	Name
14579	22434	Arm Side Wheel with two 446C.....
446C	1894	" " " Set Screw.....
14607	22419	" " " Shaft.....
122328	22419	" " " " Bushing.....
434C	1894	" " " " Set Screw..
56537	22419	" " " " Gear with 453C....
2117	1894	" " " " Pin.....
453C	1894	" " " " Set Screw....
144D	1894	" " " " Screw.....
8708	22419	" Spool Pin.....
11241	1894	" " " Washer (cloth).....
122301	22435	Balance Wheel with two 354C.....
122302	-----	" " " 122301 with 11442, 122469, two 1402D and four 401E.....
25362	1894	Balance Wheel Ball, size 3/16 in.....
122303	-----	" " " Ring.....
122304	22419	" " " 122303 with eighteen 25362.....
122306	22419	Balance Wheel Ball Washer (left).....
122469	22419	" " " " (right).....
1402D	1894	" " " " Screw.....
11442	22435	" " " Friction Washer (paper)..
401E	1894	" " " " Screw....
354C	1895	" " " Set Screw.....
56626	22441	Cloth Plate.....
56627	22441	" " Bracket with two 1107C.....
1107C	1895	" " " Set Screw.....
56629	-----	Cloth Plate complete, for 1 in. to 4 1/2 in. grommet holes, Nos. 14760, 56626, 56627 and eight 389D.....
389D	1895	Cloth Plate Screw.....
56718	22437	Crank Connecting Rod with two 145E.....
145E	1895	" " " Cap Screw.....
565C	1895	" " " Hinge Screw.....
1513J	1898	" " " " Nut....
*56717	-----	Cylinder, 5 in. diam., with 436C, 4448 and 122391.....
11367	22422	Feed Cam with two 445C.....
445C	1894	" " Set Screw.....
11368	22419	" Connecting Link.....
565C	1895	" " " Hinge Screw.....
1513J	1898	" " " " Nut....
56719	22425	" Dog, 7 teeth (12 teeth to the inch) for 56742, 56744, 56746, 122393 to 122397 and 122408.....
56720	22424	Feed Dog (left) 11 teeth (10 teeth to the inch) for 56747.....
56721	22424	Feed Dog (right) 11 teeth (10 teeth to the inch) for 56748.....
56722	22424	Feed Dog Adjusting Piece.....
56723	22425	" " " Carrier.....
1300E	22410	" " " Screw.....
176D	1895	" " " Screw.....

PARTS FOR MACHINE NO. 11-32

No.	Plate	Name
56724	22437	Feed Forked Connection.....
565C	1895	" " " Hinge Screw.....
1513J	1898	" " " " Nut..
6132	1895	" " " Universal Joint..
212C	1895	" " " " Cap Screw.....
23C	1895	Feed Forked Connection Universal Joint Hinge Screw.....
14583	22419	Feed Regulator.....
568E	1895	" " Hinge Screw.....
254D	22419	" " Thumb Screw.....
56725	22442	" Rock Shaft.....
14504	22414	" " " for 56533.....
14505	22414	" " " Arm with 436C.....
56707	22431	" " " 14505 with 212C and 6132.....
*56533	-----	Feed Rock Shaft Arm 56707 with 14504 and 14524.....
2117	1894	Feed Rock Shaft Arm Pin.....
436C	1895	" " " Set Screw.....
4448	1895	" " " Back Bearing Oil Tube..
56726	22414	" " " Crank (forked) with 445C.....
14522	22414	Feed Rock Shaft Crank with 445C.....
14524	-----	Feed Rock Shaft Crank complete, Nos. 164D 6312, 14522 and 14523.....
2117	1894	Feed Rock Shaft Crank Pin.....
56277	1895	" " " " for 56726....
14523	1895	" " " " Roller.....
164D	1895	" " " " Cap Screw..
6312	1895	" " " " Washer.....
445C	1894	Feed Rock Shaft Crank Set Screw.....
304C	1896	" " " Screw Center.....
1513J	1898	" " " " Nut.....
56727	22441	" Rod with 122416.....
23C	1895	" " Hinge Screw.....
122416	1896	" " " Bushing.....
14501	1896	" " Spring.....
219D	1896	" " Screw.....
56728	22411	Grommet Hole Center Guide (steel) for 3/8 in. hole, for 56742.....
122407	22411	Grommet Hole Center Guide (steel) for 3/8 in. ring, for 122408.....
14740	22411	Grommet Hole Center Guide (steel) for 1/2 in. ring or 7/16 in. hole, for 56744.....
14741	22411	Grommet Hole Center Guide (steel) for 5/8 in. ring or 1/2 in. hole, for 56746.....
14742	22411	Grommet Hole Center Guide (steel) for 3/4 in. ring or 5/8 in. hole, for 122393.....

PARTS FOR MACHINE NO. II-32

No.	Plate	Name
14743	22411	Grommet Hole Center Guide (steel) for 7/8 in. ring or 3/4 in. hole, for 122394.....
14744	22411	Grommet Hole Center Guide (steel) for 1 in. ring, for 122395.....
14745	22411	Grommet Hole Center Guide (steel) for 1 in. hole, for 122396.....
14746	22411	Grommet Hole Center Guide (steel) for 1 1/4 in. hole, for 122397.....
14747	22411	Grommet Hole Center Guide (wood) for 1 1/2 in. hole, for 122398.....
14748	22411	Grommet Hole Center Guide (wood) for 1 3/4 in. hole, for 122398.....
14749	22412	Grommet Hole Center Guide (wood) for 2 in. hole, for 122398.....
14750	22412	Grommet Hole Center Guide (wood) for 2 1/4 in. hole, for 122398.....
14751	22412	Grommet Hole Center Guide (wood) for 2 1/2 in. hole, for 122398.....
14752	22412	Grommet Hole Center Guide (wood) for 2 3/4 in. hole, for 122398.....
14753	22412	Grommet Hole Center Guide (wood) for 3 in. hole, for 122398.....
14754	22412	Grommet Hole Center Guide (wood) for 3 1/4 in. hole, for 122398.....
14755	22412	Grommet Hole Center Guide (wood) for 3 1/2 in. hole, for 122398.....
14756	22412	Grommet Hole Center Guide (wood) for 3 3/4 in. hole, for 122398.....
14757	22413	Grommet Hole Center Guide (wood) for 4 in. hole, for 122398.....
14758	22413	Grommet Hole Center Guide (wood) for 4 1/4 in. hole, for 122398.....
14759	22413	Grommet Hole Center Guide (wood) for 4 1/2 in. hole, for 122398.....
14026	1896	Grommet Hole Center Guide Position Pin, for 56743 and 56745.....
846D	1896	Grommet Hole Center Guide Position Screw, for 122398.....
175D	1896	Grommet Hole Center Guide Screw, for 1/2 to 1 1/4 in. center guides....
376D	1896	Grommet Hole Center Guide Screw, for 1 1/2 to 4 1/2 in. center guides..
14760	22414	Grommet Hole Center Guide Screw Block, for 56629.....
389F	1895	Grommet Hole Center Guide Screw Block Screw.....
11538	22421	Needle Bar.....
*11539	22414	" " Connecting Link.....
566C	1896	" " " " Hinge Screw..
1513J	1898	" " " " " Nut
11383	22414	" " " Stud with two 445F

PARTS FOR MACHINE NO. II-32

No.	Plate	Name
19981	-----	Needle Bar Connecting Stud 11383 with 11539.....
445F	1894	Needle Bar Connecting Stud Set Screw...
14728	22421	" " Frame with 190J and 14732...
14610	22420	" " " Cam.....
56540	-----	Needle Bar Frame Cam complete, Nos. 14610 56541 and two 159D.....
56541	22420	Needle Bar Frame Cam Bevel Gear.....
567C	1896	" " " " " " Screw..
14613	22420	" " " " " Cover.....
219D	1896	" " " " " " Screw.....
159D	1896	" " " " " " Screw.....
56542	22420	" " " " " Driving Bevel Pinion with two 445C.....
445C	1894	Needle Bar Frame Driving Bevel Pinion Set Screw.....
14615	22420	Needle Bar Frame Hinge Pin.....
435C	1896	" " " " " " Set Screw...
14729	22421	" " " " " Pitman.....
1371C	1896	" " " " " Hinge Screw....
14730	22420	" " " " " " Stud.....
14731	1898	" " " " " " Collar with 448C.....
448C	1896	Needle Bar Frame Pitman Hinge Stud Collar Set Screw.....
56544	-----	Needle Bar Frame Regulator with 217E, 236E, 1876, 14026 and 56545.....
50676E	1896	Needle Bar Frame Regulator Adjusting Screw.....
14616	1896	Needle Bar Frame Regulator Adjusting Screw Sleeve.....
236E	1896	Needle Bar Frame Regulator Adjusting Screw Stop Screw (lower).....
217E	1898	Needle Bar Frame Regulator Adjusting Screw Stop Screw (upper).....
1714C	1898	Needle Bar Frame Regulator Adjusting Screw Nut.....
17738	1896	Needle Bar Frame Regulator Adjusting Screw Nut Washer.....
1876	1896	Needle Bar Frame Regulator Roller and Screw Stud.....
56545	22420	Needle Bar Frame Regulator Shaft.....
14026	1896	" " " " " Pin....
164D	1895	" " " " " Screw.....
41544	1896	" " " " " Washer.
14732	1898	" " " " " Thread Guard.....
190J	1896	" " " " " " Screw....
56522	1896	" " " " " Washer (steel).....
19702	1898	" " " " " Clamp with 680F and 11385.....
*11385	-----	" " " " " Gib.....
680F	1898	" " " " " Thumb Screw.....
58253	22436	Oil Cup.....
11917	22436	" " " Cover.....

PARTS FOR MACHINE NO. II-32

No.	Plate	Name
9084	22420	Oil Cup Cover Hinge Pin.....
2205	1898	" " " Latch Spring.....
207F	1898	" " " " Screw.....
8953	1898	" " " or Wax Stripper (felt).....
8482	1898	" " " " Washer (steel).....
11918	1898	" " " " (steel).....
207F	1898	" " " " Screw.....
58254	22436	Oil Cup complete, Nos. 2205, 8482, 9084, 11917, 11918, 58253, two 8953 and three 207F.....
134D	1898	Oil Cup Screw.....
*56534	22414	Oscillating Rock Shaft (steel).....
56535	-----	Oscillating Rock Shaft complete, Nos. 622C, 11165, 11398, 56534 and two 1508E.....
11398	22414	Oscillating Rock Shaft Hinge Pin.....
1508E	1898	" " " " " Nut....
622C	1898	" " " " " Screw
		Bearing.....
1508E	1898	Oscillating Rock Shaft Hinge Pin Screw Bearing Nut.....
11165	1899	Oscillating Rock Shaft Oil Pad.....
56729	22442	" " Shaft.....
122391	22420	" " " Bushing.....
436C	1895	" " " " Set Screw....
56730	22420	" " " Crank.....
56731	22420	Oscillating Shaft Crank complete, Nos. 445C, 1513J, 5868 and 56730.....
58277	1895	Oscillating Shaft Crank Pin.....
445C	1894	" " " " Set Screw.....
9119	1898	" " " " Slide Block....
5868	1898	Oscillating Shaft Crank Slide Block complete, Nos. 190J, 1054C, 5868 and 9119.....
190J	1896	Oscillating Shaft Crank Slide Block Cap Screw.....
5968	1899	Oscillating Shaft Crank Slide Block Cap Screw Washer.....
1054C	1898	Oscillating Shaft Crank Slide Block Screw Stud.....
1513J	1898	Oscillating Shaft Crank Slide Block Screw Stud Nut.....
14603	22417	Presser Bar.....
14532	22420	" " " Guide Bracket with 145D and 445C.....
145D	1895	Presser Bar Guide Bracket Adjusting Screw.....
14617	22423	Presser Bar Guide Bracket Guide with 2022.....
381D	1898	Presser Bar Guide Bracket Guide Screw..
445C	1894	" " " " " Set Screw....
14761	22421	" " " Lifter.....
8760	22420	" " " " Friction Washer.....

PARTS FOR MACHINE NO. II-32

No.	Plate	Name
50063D	22414	Presser Bar Lifter Hinge Screw.....
1513J	1898	" " " " " Nut.....
194D	1898	" " " " Screw Stud.....
2022	1899	" " " " Stop Pin.....
11991	22417	" " " Spring.....
11411	1899	" " " Collar with 453C....
453C	1894	" " " " Set Screw....
56732	22424	" " Foot (left).....
56733	22424	" " (right).....
14762	22424	" " for grommet holes.....
14763	22424	" " " rings.....
190J	1896	" " " Screw.....
16901	22422	Shuttle Bobbin.....
56734	22422	" " Cylinder.....
122322	-----	" " " 56734 with 1323F and 56736.....
8777	1899	Shuttle Cylinder Hinge Pin.....
43239	22422	" " " Latch.....
43236	1899	" " " " Hinge Pin.....
19869	1899	" " " " Spring.....
56735	22422	" " Frame.....
122323	-----	" " " 56735 with 19869, 43236 and 43239.....
1323F	1899	Shuttle Tension Regulating Screw.....
56736	22422	" " " Spring.....
56737	22422	Shuttle (cylinder) 4 in. diam. complete Nos. 8777, 16901, 122322 and 122323..
56738	22422	Shuttle Driver.....
58277	1895	" " " Pin.....
56739	22418	" " Race.....
56740	22418	" " " Ring.....
32885	22423	" " " " Cap.....
96D	1899	" " " " Screw.....
21788	1899	" " " " Spring.....
50173E	1899	" " " " Screw.....
14766	1897	Tension (lower) Bracket.....
190J	1896	" " " " Screw.....
8879	1897	" " " Friction Washer (cloth)
11043	1897	" " " " (steel)
1560C	1899	" " " Regulating Thumb Nut...
8905	1899	" " " " "
		Washer.....
632E	22418	Tension (lower) Screw Stud.....
58596	-----	" " " " 632E with 1560C.....
8791	1897	Tension (lower) Spring.....
11044	1897	" " " Wheel.....
2102	1897	" (upper) Disc.....
1560C	1899	" " " Regulating Thumb Nut...
8905	1899	" " " " "
		Washer.....
14767	1897	Tension (upper) Releaser.....
14768	22423	" " " " Body.....

No.	Plate	Name
14769	1897	Tension (upper) Releaser Body Block (lower).....
401D	1894	Tension (upper) Releaser Body Block (lower) Screw.....
14770	1897	Tension (upper) Releaser Body Block (upper).....
401D	1894	Tension (upper) Releaser Body Block (upper) Screw.....
756D	1898	Tension (upper) Releaser Screw.....
14771	-----	Tension (upper) Releaser complete, Nos. 14767 to 14770, two 756D and four 401D.....
50064E	1899	Tension (upper) Screw Stud.....
*56546	-----	" " " " 50064E with 1560C.....
2103	1899	Tension (upper) Spring.....
11950	1899	" " Thread Eyelet.....
11428	22423	Thread Take-up Cam with two 434C.....
8873	1899	" " " Pin.....
434C	1894	" " " Set Screw.....
*58331	-----	" " " Lever.....
58332	22414	" " " 58331 with 1995 and 9219.....
58333	-----	Thread Take-up Lever 58332 with 50437D.
50437D	22416	" " " Hinge Screw.....
1995	1899	" " " Roller and Screw. Stud with 1518E.....
1518E	1899	Thread Take-up Lever Roller and Screw Stud Nut.....
9219	1899	Thread Take-up Lever Thread Eyelet Bushing.....
8798	1899	Thread Take-up Spring.....
14824	22401	" " " Regulator Plate..
190E	1896	" " " " " " Adjusting Screw.....
14772	22401	Thread Take-up Spring Staple.....
890D	1899	" " " " " Screw.....
41544	1896	" " " " " Washer
56741	22425	Throat Plate, for 56742 and 122408.....
56742	-----	" " 56741 with 175D and 56728, for 3/8 in. hole, for 56719.....
56743	22425	Throat Plate with 14026, for 56744.....
56744	-----	" " 56743 with 175D and 14740, for 1/2 in. ring, for 56719.....
56745	22425	Throat Plate with 14026, for 56746 and 122393 to 122397.....
122408	-----	Throat Plate 56741 with 175D and 122407 for 3/8 in. ring, for 56719.....
56746	-----	Throat Plate 56745 with 175D and 14741, for 5/8 in. ring, for 56719.....
122393	-----	Throat Plate 56745 with 175D and 14742, for 3/4 in. ring, for 56719.....

No.	Plate	Name
122394	-----	Throat Plate 56745 with 175D and 14743, for 7/8 in. ring, for 56719.....
122395	-----	Throat Plate 56745 with 175D and 14744, for 1 in. ring, for 56719.....
122396	-----	Throat Plate 56745 with 175D and 14745, for 1 in. hole, for 56719.....
122397	-----	Throat Plate 56745 with 175D and 14746, for 1 1/4 in. hole, for 56719.....
122398	-----	Throat Plate with 846D, for 1 1/2 in. to 4 1/2 in. holes, for 14747 to 14759 and 56719.....
56747	22424	Throat Plate (left) for 56720.....
56748	22424	" " (right) for 56721.....
56749	22425	" " Holder.....
164F	1895	" " " Screw.....
202D	22401	" " " Screw (long).....
228D	22401	" " " (short).....
*15404	-----	Trade Mark.....
15405	-----	" " Rivet.....

Genuine Singer Needles should be used in Singer Machines. These Needles and their Containers are marked with the Company's Trade Mark "SIMANCO." 1

Needles in Containers marked "For Singer Machines" are not Singer made needles. 2

MACHINE No. II-34

For Stitching Tents, Tarpaulins, Wagon Covers and other
Work in Canvas. Drop feed. Feed across the cylinder, Alternating
pressers, flexible shuttle race, foot lifter and S. D. A. Pulley No.
11440, diameter 7 inches. Speed 600 R. P. M.

No.	Plate	Name
*122368	-----	Arm.....
122369	-----	" 122368 with 65D, 14710, 15404, 122372, two each 437C and 15405.....
8702	22401	Arm Dowel Pin.....
338E	22401	" Screw.....
122313	22442	" Shaft.....
122314	22418	" Bushing.....
446C	1894	" Set Screw.....
17429	22418	" Gear with 453C.....
2117	1894	" Pin.....
453C	1894	" Set Screw.....
144D	1894	" Screw.....
14710	22434	Side Cover.....
65D	1894	" Hinge Screw.....
11957	22434	" Wheel with two 446C.....
446C	1894	" Set Screw.....
6805	22417	" Shaft.....
56539	-----	" 6805 with 11957...
122372	22417	" Bushing.....
437C	1894	" Set Screw.....
17430	22418	" Gear with 453C.....
2117	1894	" Pin.....
453C	1894	" Set Screw....
144D	1894	" Screw.....
8708	22419	Spool Pin.....
11241	1894	" Washer (cloth).....
122315	22435	Balance Wheel with two 354C.....
122316	-----	" 122315 with 11442, 122469, two 1402D and four 401E.....
25362	1894	Balance Wheel Ball size 3/16 in.....
*122317	-----	" Ring (brass).....
122318	22419	" 122317 with eighteen 25362.....
122319	22417	Balance Wheel Ball Washer (left).....
122469	22419	" (right).....
1402D	1894	" Screw.....
11442	22435	Friction Washer (paper)..
401E	1894	" Screw....
354C	1895	Set Screw.....
12096	22437	Crank Connecting Rod with two 145E.....

No.	Plate	Name
145E	1895	Crank Connecting Rod Cap Screw.....
565C	1895	" Hinge Screw.....
1513J	1898	" Nut...
*122377	-----	Cylinder, 3 1/8 in. diam.....
3032	22414	Feed Cam with 446C.....
446C	1894	" Set Screw.....
3033	22401	" Connecting Link.....
375C	22401	" Hinge Screw.....
1518E	1899	" Nut...
56602	22427	" Dog, 10 teeth (13 teeth to the inch) for 56608.....
14715	22414	Feed Dog Carrier.....
792C	22401	" Screw.....
12097	22437	" Forked Connection.....
372C	22401	" Hinge Screw.....
1518E	1899	" Nut..
12091	22403	" Regulator.....
58E	22401	" Hinge Screw.....
50322D	22403	" Thumb Screw.....
12087	22437	" Rock Shaft.....
14630	-----	Feed Rock Shaft complete, Nos. 12087 and 14631.....
*56709	-----	Feed Rock Shaft 14630 with 14715.....
4448	1895	" Back Bearing Oil Tube..
14631	22417	" Crank with 453C.....
2117	1894	" Pin.....
453C	1894	" Set Screw.....
11475	22417	Lifting Presser Bar.....
11476	22415	" Bell Crank.....
166D	22401	" Hinge Cap Screw.....
1851	22401	Lifting Presser Bar Bell Crank Lifting Roller with 610D.....
610D	22401	Lifting Presser Bar Bell Crank Lifting Roller Screw.....
1518E	1899	Lifting Presser Bar Bell Crank Lifting Roller Screw Nut.....
2718	22402	Lifting Presser Bar Bell Crank Lifting Roller Screw Nut Washer.....
58643	22415	Lifting Presser Bar Bracket with two 145E.....
145E	1895	Lifting Presser Bar Bracket Clamping Screw.....
11909	22421	Lifting Presser Bar Lifter with 8761 and 8763.....
8760	22420	Lifting Presser Bar Lifter Friction Washer.....
16D	22403	Lifting Presser Bar Lifter Hinge Screw.
9761	22402	" Stop Pin....
11907	22415	" Lifting Link.....
166D	22401	" Cap Screw.....

PARTS FOR MACHINE NO. II-34

No.	Plate	Name
9763	22402	Lifting Presser Bar Lifting Link Hinge Stud.....
7958	22402	Lifting Presser Bar Lifting Link Hinge Stud Pin.....
43267	22402	Lifting Presser Bar Lifting Link Hinge Stud Washer.....
11479	22416	Lifting Presser Bar Rock Shaft.....
58578	22417	" " " " Adjusting Arm with 453C.....
2117	1894	Lifting Presser Bar Rock Shaft Adjusting Arm Pin.....
453C	1894	Lifting Presser Bar Rock Shaft Adjusting Arm Set Screw.....
11481	22415	Lifting Presser Bar Rock Shaft Bracket.....
*58245	-----	" " " " " " 11481 with 2117, 11479, 11484 and 58578.....
2002	22402	Lifting Presser Bar Rock Shaft Bracket Dowel Pin (lower).....
4389	22402	Lifting Presser Bar Rock Shaft Bracket Dowel Pin (upper).....
123E	22403	Lifting Presser Bar Rock Shaft Bracket Screw.....
11484	22415	Lifting Presser Bar Rock Shaft Crank with 453C and 1850.....
2117	1894	Lifting Presser Bar Rock Shaft Crank Pin.....
1850	22402	Lifting Presser Bar Rock Shaft Crank Roller and Stud.....
453C	1894	Lifting Presser Bar Rock Shaft Crank Set Screw.....
11486	22415	Lifting Presser Bar Rock Shaft Eccentric Strap with two each 141E and 1528C.....
141E	22402	Lifting Presser Bar Rock Shaft Eccentric Strap Adjusting Screw.....
1528C	22402	Lifting Presser Bar Rock Shaft Eccentric Strap Adjusting Screw Nut....
608C	22403	Lifting Presser Bar Rock Shaft Eccentric Strap Hinge Screw.....
1513E	1899	Lifting Presser Bar Rock Shaft Eccentric Strap Hinge Screw Nut.....
11487	22410	Lifting Presser Bar Rock Shaft Eccentric Strap Hinge Screw Slide.....
11488	22403	Lifting Presser Bar Rock Shaft Eccentric Strap Hinge Screw Slide Washer.....
258E	22402	Lifting Presser Bar Screw Bushing.....
11489	22415	" " " " Sleeve (lower).....
11490	22416	" " " " (upper).....
11491	-----	" " " " " " 11490 with 11492.....

PARTS FOR MACHINE NO. II-34

No.	Plate	Name
11492	22402	Lifting Presser Bar Sleeve (upper) Cap.
11493	22436	" " " " Spring (flat).....
58252	22416	" " " " Bracket.....
1177D	22402	" " " " " " Screw
4389	22402	" " " " " " Guide Pin...
19951	22427	" " " " " " Foot with 211F.....
2049	22402	" " " " " " Pin.....
211F	22402	" " " " " " Set Screw.....
11538	22421	Needle Bar.....
11539	22414	" " " " Connecting Link.....
566C	1896	" " " " " " Hinge Screw.
1513J	1898	" " " " " " " "
11383	22414	Nut.....
19981	-----	Needle Bar Connecting Stud with two 445F.....
445F	1894	Needle Bar Connecting Stud 11383 with 11539.....
258C	22402	Needle Bar Connecting Stud Set Screw...
19702	1898	" " " " Screw Bushing.....
*11385	-----	" " " " Clamp with 680F and 11385.....
680F	1898	" " " " " " Gib.....
58253	22436	" " " " " " Thumb Screw.....
11917	22436	Oil Cup.....
9084	22420	" " " " " " Cover.....
2205	1898	" " " " " " Hinge Pin.....
207F	1896	" " " " " " Latch Spring.....
8953	1898	" " " " " " Screw.....
8482	1896	" " " " " " or Wax Stripper (felt).....
11918	1998	" " " " " " Washer (steel) for 58253.....
207F	1896	Oil or Wax Stripper Washer (steel)....
58254	22436	" " " " " " Screw.....
134D	1898	Oil Cup complete, Nos. 2205, 8482, 9084, 11917, 11918, 58253, two 8953 and three 207F.....
*12090	22416	Oil Cup Screw.....
11164	22416	Oscillating Rock Shaft with 11165.....
435C	1896	" " " " " " Hinge Pin.....
11165	1899	" " " " " " " " Set Screw.....
56530	-----	Oscillating Rock Shaft Oil Pad.....
122383	22436	" " " " " " 12090 with 11164.
122381	22416	" " " " " " Shaft with 2049 and 56712..
435C	1896	" " " " " " Bushing (front).....
12088	22416	" " " " " " Set Screw....
14633	22416	" " " " " " Crank.....
2117	1894	Oscillating Shaft Crank complete, Nos. 453C, 1513J, 5868 and 12088.....
453C	1894	Oscillating Shaft Crank Pin.....
9119	1898	" " " " " " Set Screw.....
		" " " " " " Slide Block....

PARTS FOR MACHINE NO. II-34

No.	Plate	Name
5868	1898	Oscillating Shaft Crank Slide Block complete, Nos.190D,1054C,5968 and 9119.....
190D	1898	Oscillating Shaft Crank Slide Block Cap Screw.....
5968	1899	Oscillating Shaft Crank Slide Block Cap Screw Washer.....
1054C	1898	Oscillating Shaft Crank Slide Block Screw Stud.....
1513J	1998	Oscillating Shaft Crank Slide Block Screw Stud Nut.....
*56712	-----	Oscillating Shaft Sleeve, for 122383...
2049	22402	" " Pin.....
50323D	22402	Pressure Regulating Thumb Screw.....
14535	22406	Shuttle Bobbin.....
122417	22406	" Cylinder.....
122418	-----	" " 122417 with 773F and 122422.....
122409	22406	Shuttle Cylinder Hinge Pin.....
122410	22406	" " Latch.....
12002	22406	" " Pin.....
122419	22408	" " Spring.....
122420	22406	" Frame.....
122421	-----	" " 122420 with 12002,122410 and 122419.....
773F	22406	Shuttle Tension Regulating Screw.....
122422	22408	" " Spring.....
122423	22406	Shuttle (cylinder) 2 1/2 in. diam. complete, Nos.14535,122409,122418 and 122421.....
56713	22406	Shuttle Driver and Feed Lifting Cam....
2049	22402	" " Pin
14554	22427	" Race.....
122332	22427	" Ring.....
119C	22410	" Screw.....
11502	22416	Tension Bracket and Vibrating Presser Bar Cap with 11424.....
11501	-----	Tension Bracket and Vibrating Presser Bar Cap complete, Nos.122E,9525, 11502,11506,11936,11937,12042 and two 190E.....
159F	1896	Tension Bracket and Vibrating Presser Bar Cap Screw (left).....
145F	1895	Tension Bracket and Vibrating Presser Bar Cap Screw (right).....
5983	22402	Tension Friction Washer (felt).....
11423	22402	" " (steel).....
1560C	1899	" Regulating Thumb Nut.....
8905	1899	" " Washer....
607E	22416	" Screw Stud.....
58598	-----	" " 607E with 1560C.....
122E	22402	" " Clamping Screw.....
8791	1897	" Spring.....

PARTS FOR MACHINE NO. II-34

No.	Plate	Name
11044	1897	Tension Wheel.....
12042	-----	Tension Wheel complete, Nos.8791,8905, 11044,11423,58598 and two 5983....
11424	22402	Thread Eyelet (front of arm) for 11502.
11950	1899	" " (side of arm) for 11503..
11495	22408	" " (side of arm).....
190J	1896	" " " " " Screw.....
2102	1897	" Retaining Disc.....
1560C	1899	" Regulating Thumb Nut..
8905	1899	" " " " " "
606E	22408	Washer.....
58597	-----	Thread Retaining Screw Stud.....
2103	1899	" " " " 606E with 1560C.....
11503	-----	Thread Retaining Spring.....
12044	22423	Thread Retainer complete, Nos.2103,8905, 58597 and two 2102.....
8873	1899	Thread Take-up Cam with two 434C.....
434C	1894	" " " Pin.....
58295	-----	" " " Set Screw.....
58296	22416	" " Lever.....
58296	-----	" " " 58295 with 1995...
58296	-----	" " " 58296 with 50437D.
50437D	22416	" " " Hinge Screw.....
1995	1899	" " " Roller and Screw Stud with 1518E.....
1518E	1899	Thread Take-up Lever Roller and Screw Stud Nut.....
11506	22408	Thread Take-up Spring.....
11936	22408	" " " Regulator Plate..
190E	1896	" " " " " "
11937	22408	Adjusting Screw.....
9525	22408	Thread Take-up Spring Staple.....
56607	-----	" " " Washer.....
14563	-----	Throat Plate Body.....
401D	1894	" " " Needle Hole Strip.....
56608	22427	" " " " " Screw...
14783	22427	Throat Plate complete for 56602, Nos. 14563,56607 and two 401D.....
389F	1895	Throat Plate Holder.....
202D	22401	" " " Screw.....
228D	22401	" " " Screw (long).....
56609	22430	" " " (short).....
11509	22408	Vibrating Presser Bar.....
233D	22408	" " " Cushion (rawhide)
122384	22430	" " " " " Screw....
145F	1895	" " " Hinge Bracket with 145F.....
164D	1895	Vibrating Presser Bar Hinge Bracket Ad-justing Screw.....
41544	1896	Vibrating Presser Bar Hinge Cap Screw..
		" " " " " " Washer.....

No.	Plate	Name
11512	22430	Vibrating Presser Bar Spring.....
11939	22408	" " " " Adjusting Staple.....
190J	1896	Vibrating Presser Bar Spring Adjusting Staple Screw.....
223D	22408	Vibrating Presser Bar Spring Screw.....
56610	22427	" " " Foot.....
898D	22408	" " " Screw.....
1528J	22402	" " " Nut.....
*15404	-----	Trade Mark.....
15405	-----	" " Rivet.....

**Genuine Singer Needles should be used
in Singer Machines.
These Needles and their Containers
are marked with the
Company's Trade Mark "SIMANCO." 1**

**Needles in Containers marked
"For Singer Machines"
are not Singer made needles. 2**

MACHINE No. 11-35

For Military Boot Legs and Similar Tubular Work. Drop
feed up the cylinder and parts to change to feed across the cylinder.
S. D. A. No. 122435. Balance wheel No. 122316. Pulley No. 11440.
Diameter 7 inches. Speed 650 R. P. M.

No.	Plate	Name
*122366	-----	Arm.....
122367	-----	" 122366 with 65D, 12453, 14710, 15404, 122372, two each 437C and 15405....
8702	22401	Arm Dowel Pin.....
12453	22404	" Oil Tube, for intermediate bearing.
338E	22401	" Screw.....
122360	22442	" Shaft.....
122314	22418	" " Bushing.....
435C	1896	" " " Set Screw.....
17429	22418	" " " Gear with 453C.....
2117	1894	" " " Pin.....
453C	1894	" " " Set Screw.....
144D	1894	" " " Screw.....
14710	22434	" Side Cover.....
65D	1894	" " " Hinge Screw.....
11957	22434	" " " Wheel with two 448C.....
446C	1894	" " " Set Screw.....
6805	22417	" " " Shaft.....
56539	-----	" " " " 6805 with 11957...
122372	22417	" " " " Bushing.....
437C	1894	" " " " Set Screw.
56624	22404	" " " " Gear with 453C....
2117	1894	" " " " Pin.....
453C	1894	" " " " Set Screw....
144D	1894	" " " " Screw.....
8708	22419	" Spool Pin.....
11241	1894	" " " Washer (cloth).....
122315	22435	Balance Wheel with two 354C.....
122316	-----	" " " 122315 with 11442, 122469, two 1402D and four 401E.....
25362	1894	Balance Wheel Ball, size 3/16 in.....
*122317	-----	" " " Ring (brass).....
122318	22419	" " " " 122317 with eighteen 25362.....
122319	22417	Balance Wheel Ball Washer (left).....
122469	22419	" " " " (right).....
1402D	1894	" " " " Screw.
11442	22435	" " " Friction Washer (paper)..
401E	1894	" " " " Screw....
354C	1895	" " " Set Screw.....

No.	Plate	Name
14540	22437	Crank Connecting Rod with two 145E.....
145E	1895	" " " Cap Screw.....
565C	1895	" " " Hinge Screw.....
1513J	1898	" " " Nut....
*122375	-----	Cylinder, 3 1/8 in. diam.....
3032	22414	Feed Cam with 446C.....
446C	1894	" " Set Screw.....
3033	22401	" Connecting Link.....
375C	22401	" " Hinge Screw.....
1518E	1899	" " " Nut...
14716	22426	" Dog, (left) 14 teeth (14 teeth to the inch) for 14520.....
14570	22426	Feed Dog (double) 15 teeth (12 teeth to the inch) for 14574 and 14681.....
14733	22426	Feed Dog Adjusting Piece.....
14715	22414	" " " Carrier.....
792C	22401	" " " Screw.....
176D	1895	" " Screw.....
12062	22437	" Forked Connection.....
375C	22401	" " " Hinge Screw....
1518E	1899	" " " Nut.
6132	1895	" " " Universal Joint.
212C	1895	" " " " "
		Cap Screw.....
23C	1895	Feed Forked Connection Universal Joint Hinge Screw.....
11970	22403	Feed Regulator.....
58E	22401	" " Hinge Screw.....
818D	22404	" " Thumb Screw.....
14545	22437	" Rock Shaft.....
14565	22431	" " " for 122403.....
14505	22414	" " " Arm with 436C.....
56707	22431	" " " 14505 with 212C and 6132.....
122403	-----	Feed Rock Shaft Arm 56707 with 14524 and 14565.....
2117	1894	Feed Rock Shaft Arm Pin.....
436C	1895	" " " Set Screw.....
4448	1895	" " " Back Bearing Oil Tube..
14526	22430	" " " Crank (forked) with 445C.....
14522	22414	Feed Rock Shaft Crank with 445C.....
14524	-----	Feed Rock Shaft Crank complete, Nos. 164D 6312, 14522 and 14523.....
3012	1894	Feed Rock Shaft Crank Pin, for 14526...
2117	1894	" " " " 14522...
14523	1895	" " " " Roller.....
164D	1895	" " " " Cap Screw..
6312	1895	" " " " " "
		Washer.....
445C	1894	Feed Rock Shaft Crank Set Screw.....
304C	1896	" " " Screw Center.....
1513J	1898	" " " " Nut.....

No.	Plate	Name
14566	22436	Feed Rod with 122416.....
23C	1895	" " Hinge Screw.....
122416	1896	" " " Bushing.....
14501	1896	" " Spring.....
219D	1896	" " Screw.....
11975	22431	Needle Bar.....
*11976	22431	" " Connecting Link.....
375C	22401	" " " Hinge Screw.
1518E	1899	" " " " "
		Nut.....
14547	22431	Needle Bar Connecting Stud with two 453C.....
453C	1894	Needle Bar Connecting Stud Set Screw...
56529	-----	" " " 14547 with 11976.....
258C	22402	Needle Bar Screw Bushing.....
19702	1898	" Clamp with 680F and 11385.....
*11385	-----	" " Gib.....
680F	1898	" " Thumb Screw.....
58253	22436	Oil Cup.....
11917	22436	" " Cover.....
9084	22420	" " Hinge Pin.....
2205	1898	" " Latch Spring.....
207F	1896	" " " Screw.....
8953	1898	" or Wax Stripper (felt).....
8482	1896	" " " Washer (steel)....
11918	1898	" " " " (steel).....
207F	1896	" " " " Screw.....
58254	22436	Oil Cup complete, Nos. 2205, 8482, 9084, 11917, 11918, 58253, two 8953 and three 207F.....
134D	1898	Oil Cup Screw.....
*12090	22416	Oscillating Rock Shaft with 11165.....
11164	22416	" " " Hinge Pin.....
435C	1896	" " " " Set Screw.....
11165	1899	Oscillating Rock Shaft Oil Pad.....
56530	-----	" " " 12090 with 11164
122424	22436	" Shaft with 2049 and 56712..
122381	22416	" " Bushing (front).....
122425	22408	" " Collar with two 453C.
453C	1894	" " " Set Screw....
122430	22431	" " Crank.....
122431	22431	Oscillating Shaft Crank complete, Nos. 453C, 1513J, 5868 and 122430.....
2117	1894	Oscillating Shaft Crank Pin.....
453C	1894	" " " Set Screw.....
9119	1898	" " " Slide Block....
5868	1898	Oscillating Shaft Crank Slide Block complete, Nos. 190D, 1054C, 5968 and 9119.....
190D	1896	Oscillating Shaft Crank Slide Block Cap Screw.....

PARTS FOR MACHINE NO. II-35

No.	Plate	Name
5968	1899	Oscillating Shaft Crank Slide Block Cap Screw Washer.....
1054C	1898	Oscillating Shaft Crank Slide Block Screw Stud.....
1513J	1898	Oscillating Shaft Crank Slide Block Screw Stud Nut.....
*56712	-----	Oscillating Shaft Sleeve.....
2049	22402	" " " Pin.....
11986	22417	Presser Bar.....
11988	22431	" " Guide Bracket with 175D and 446C.....
175D	1896	Presser Bar Guide Bracket Adjusting Screw.....
12066	22431	Presser Bar Guide Bracket Guide with 7393.....
164D	1895	Presser Bar Guide Bracket Guide Screw..
446C	1894	" " " " " Set Screw....
11990	22431	" " " Lifter.....
685D	22408	" " " Hinge Screw.....
7393	22404	" " " Stop Pin.....
258E	22402	" " " Screw Bushing.....
11991	22417	" " " Spring.....
14559	22426	" " " Foot (left).....
14680	22426	" " " (short right toe).....
176D	1895	" " " Screw.....
1899	22407	Roller, 1 1/4 in. with 634D and 1528J..
11994	22407	" " " Arm, for 11992.....
14551	22407	" " " 14553.....
440F	22404	" " " Adjusting Screw.....
1547D	22404	" " " " " Nut.....
11995	22407	" " " Bracket, for 11992.....
14552	-----	" " " 14553.....
316F	22404	" " " " " Screw Center.....
1547D	22404	" " " " " Nut..
2205	1898	" " " Lock Spring.....
207F	1896	" " " " " Screw.....
1549D	22404	" " " " " Nut.....
634D	22404	" " " " " Screw.....
1528J	22402	" " " " " Nut.....
14553	22407	" " " Presser (left) 1 1/4 in. roller complete, Nos. 207F, 440F, 1899, 2205, 14551, 14552, two 316F and three 1547D.....
11992	22407	Roller Presser (right) 1 1/4 in. roller complete, Nos. 207F, 440F, 1899, 2205, 11994, 11995, two 316F and three 1547D.....
176D	1895	Roller Presser Screw.....
14535	22406	Shuttle Bobbin.....
11999	22405	" " " Cylinder.....
*56515	-----	" " " 11999 with 774F and 12005.....
122409	22406	Shuttle Cylinder Hinge Pin.....

PARTS FOR MACHINE NO. II-35

No.	Plate	Name
12001	22405	Shuttle Cylinder Latch.....
12002	22406	" " " " " Pin.....
11854	22404	" " " " " Spring.....
590D	22404	" " " " " Screw....
12004	22405	" " " " " Frame.....
*56526	-----	" " " " " 12004 with 590D, 11854, 12001 and 12002.....
774F	22405	Shuttle Tension Regulating Screw.....
12005	22405	" " " " " Spring.....
11997	22405	Shuttle (cylinder) 2 1/2 in. diam. complete, Nos. 14535, 56515, 56526 and 122409.....
56713	22406	Shuttle Driver and Feed Lifting Cam....
2049	22402	" " " " " " Pin.
14554	22427	" " " " " Race.....
122332	22427	" " " " " Ring.....
119C	22410	" " " " " Screw.....
12008	22405	Tension Bracket.....
190J	1896	" " " " " Screw.....
8879	1897	" " " " " Friction Washer (cloth).....
11423	22402	" " " " " (steel).....
1560C	1899	" " " " " Regulating Thumb Nut.....
8905	1899	" " " " " " Washer....
411E	22404	" " " " " Screw Stud.....
56559	-----	" " " " " 411E with 1560C....
11422	22405	" " " " " Spring.....
11044	1897	" " " " " Wheel.....
11420	-----	Tension (wheel) complete, Nos. 8905, 11044 11422, 11423, 56559 and two 8879....
14555	22404	Thread Eyelet (front of arm).....
11950	1899	" " " " " (side of arm).....
2102	1897	" " " " " Retaining Disc.....
1560C	1899	" " " " " Regulating Thumb Nut..
8905	1899	" " " " " " " Washer.....
686C	22404	Thread Retaining Screw Stud.....
56590	-----	" " " " " 686E with 1560C.....
2103	1899	Thread Retaining Spring.....
11041	-----	Thread Retainer complete, Nos. 2103, 8905, 56590 and two 2102.....
12014	22430	Thread Take-up Cam with two 435C.....
3012	1894	" " " " " Pin.....
435C	1896	" " " " " Set Screw.....
56612	-----	" " " " " Lever.....
56613	22431	" " " " " 56612 with 1995...
122404	-----	" " " " " 56613 with 50437D.
50437D	22416	" " " " " Hinge Screw.....
1995	1899	" " " " " Roller and Screw Stud with 1518E.....
1518E	1899	Thread Take-up Lever Roller and Screw Stud Nut.....
11052	22404	Thread Take-up Spring.....

PARTS FOR MACHINE NO. 11-35

No.	Plate	Name
11431	22404	Thread Take-up Spring Regulator Plate..
190E	1896	" " " " " " " "
		Adjusting Screw.....
14520	22426	Throat Plate, for 14718.....
14681	22426	" " " (rounded edges) for 14570
14574	22426	" " " for 14570.....
14519	22426	" " " Holder.....
389F	1895	" " " Screw.....
202D	22401	" " " Screw (long).....
228D	22401	" " " (short).....
*15404	-----	Trade Mark.....
15405	-----	" " Rivet.....

Genuine Singer Needles should be used
in Singer Machines.
These Needles and their Containers
are marked with the
Company's Trade Mark "SIMANCO." 1

Needles in Containers marked
"For Singer Machines"
are not Singer made needles. 2

ACCESSORIES

No.	Plate	Name
490E	22429	Bolt with 1600E, to secure machine to power table, for 11-34 and 11-35 Machines.....
953C	22429	Bolt with 1522J, to secure machine to power table, for 11-32 Machine....
1522J	22410	Bolt Nut.....
1600E	22410	" Nut.....
9281	22429	" " Washer.....
120344	22428	Oiler (copper plated) with 120345, for 11-32 and 11-35 Machines.....
120346	22428	Oiler (copper plated) with 120347, for 11-34 Machine.....
120345	22428	Oiler Spout, 4 1/2 in. long.....
120347	22428	" " 8 1/2 in. long.....
11831	22429	Screw Driver (large).....
26026	22429	" " (medium).....
26485	22429	" " (small) for 11-32 and 11-34 Machines.....
4822	22429	Wrench, for 1518, 1528 and 1547, for 11-35 Machine.....
8908	22429	Wrench, for 1520.....
8909	22429	" " 1513 and 1518.....
8910	22429	" " 1508, for 11-32 Machine....
25200	22429	" " 354.....

BOBBIN WINDERS

BOBBIN WINDER

(SWINGING AUTOMATIC, LEFT HAND)

FOR

11-32 MACHINE

No.	Plate	Name
41894	22432	Base with 449C.....
894D	22409	" Screw.....
60213	22409	Bobbin Position Pin.....
41896	22432	Frame.....
41441	22409	" Hinge Pin.....
449C	22409	" " Set Screw.....
4784	22409	" Oil Pad.....
41897	22432	" Spring.....
43270	22432	Friction Pulley with 43271, two 448C and ten 26070.....
43271	-----	Friction Pulley Ring (leather).....
26070	22409	" " Rivet (brass).....
448C	1896	" " Set Screw.....
60214	22432	Spindle.....
454C	22409	" Set Screw.....

BOBBIN WINDER

No.	Plate	Name
60215	22432	Spindle Shaft with 454C and 60213.....
60216	22432	Stop Latch.....
11107	22432	" " Hinge Pin.....
2269	22409	" " Pin.....
41899	22409	Tripping Arm with 176D.....
176D	1895	" " Clamping Screw.....
60217	-----	Bobbin Winder, Nos. 2269, 11107, 41441, 41894, 41896, 41897, 41899, 43270, 60214 to 60216 and two 4784.....
60271	22436	Bracket.....
50124D	22409	" Screw.....
9842	1894	" Washer.....

BOBBIN WINDER

(SWINGING AUTOMATIC, LEFT HAND)

FOR

II-34 AND II-35 MACHINES

No.	Plate	Name
41894	22432	Base with 449C.....
894D	22409	" Screw.....
41895	22409	Bobbin Carrier Key.....
41896	22432	Frame.....
41441	22409	" Hinge Pin.....
449C	22409	" " Set Screw.....
4784	22409	" Oil Pad.....
41897	22432	" Spring.....
43270	22432	Friction Pulley with 43271, two 449C and ten 26070.....
43271	-----	Friction Pulley Ring (leather).....
26070	22409	" " Rivet (brass).....
448C	1896	" " Set Screw.....
41898	22432	Spindle with 41895.....
60516	22432	Stop Latch.....
60735	-----	" " 60516 with 2269 and 41446...
41446	22432	" " Hinge Pin.....
2269	22409	" " Pin.....
41899	22409	Tripping Arm with 176D.....
176D	1895	" " Clamping Screw.....
60517	-----	Bobbin Winder, Nos. 41441, 41894, 41896 to 41899, 43270, 60735 and two 4784....
150650	22438	Bracket.....
126057	22438	Bracket.....
134D	1898	" Screw.....

BOBBIN WINDER

AND

THREAD UNWINDER PARTS

FOR

II-32 MACHINE

No.	Plate	Name
27555	22440	Spool Pin.....
27583	22440	" Rest.....
27556	-----	" " 27583 with 138B and two 27555
138B	22409	" " Set Screw.....
2102	1897	Tension Disc.....
1560C	1899	" Regulating Thumb Nut.....
828C	22409	" Screw Stud.....
42418	-----	" " 828C with 1560C.....
2103	1899	" Spring.....
5769	22409	" Thread Eyelet.....
17547	22409	" Guide.....
60608	22440	Thread Guard.....
60573	22439	" " Rod, 15 in. long.....
1513J	1898	" " Nut.....
330E	22409	" " Set Screw.....
60609	-----	Thread Guard complete, Nos. 330E, 2103, 5769, 17547, 42418, 60608 and two 2102.....
126054	22439	Thread Unwinder (top of arm) complete, Nos. 1513J, 27556, 60573 and 60609..
126055	-----	Bobbin Winder (swinging automatic, left hand) complete, Nos. 9842, 50124D, 60217, 60271, 126054 and three 894D.

BOBBIN WINDER

AND

THREAD UNWINDER PARTS

FOR

II-34 MACHINE

No.	Plate	Name
27555	22440	Spool Pin.....
27583	22440	" Rest.....
27556	-----	" " 27583 with 138B and two 27555
138B	22409	" " Set Screw.....
27557	22440	" Stand with 138B.....
2102	1897	Tension Disc.....
1560C	1899	" Regulating Thumb Nut.....
828C	22409	" Screw Stud.....

BOBBIN WINDER AND THREAD UNWINDER

No.	Plate	Name
42418	-----	Tension Screw Stud 829C with 1560C.....
2103	1899	" Spring.....
5769	22409	" Thread Eyelet.....
17547	22409	" " Guide.....
60608	22440	Thread Guard.....
27560	22440	" " Rod, 26 in. long.....
138B	22409	" " Set Screw.....
330E	22409	" " Set Screw.....
60609	-----	Thread Guard complete, Nos. 330E, 2103, 5769, 17547, 42418, 60608 and two 2102.....
41823	22440	Thread Unwinder complete, for two large spools, Nos. 27556, 27557, 27560, 60609 and three wood screws 1 1/4 in. No. 12.....
150651	-----	Bobbin Winder (swinging automatic, left hand) complete for 14535, Nos. 41823, 60517, 150650, two 134D and three 894D.....

**BOBBIN WINDER
AND
THREAD UNWINDER PARTS**

FOR
II-35 MACHINE

SAME AS NO. 150651 WITH THE FOLLOWING EXCEPTION:

No.	Plate	Name
126058	-----	Bobbin Winder (swinging automatic, left hand) complete, for 14535, Nos. 41823, 60517, 126057, two 134D and three 894D.....

DRIVING ATTACHMENTS

DRIVING ATTACHMENT

FOR

II-32 MACHINE

No.	Plate	Name
122301	22435	Balance Wheel with two 354C.....
122302	-----	" " 122301 with 11442, 122469, two 1402D and four 401E.....
25362	1894	Balance Wheel Ball, size 3/16 in.....
122303	-----	" " Ring.....
122304	22419	" " " " 122303 with eighteen 25362.....

DRIVING ATTACHMENT

No.	Plate	Name
122306	22419	Balance Wheel Ball Washer (left).....
122469	22419	" " " " (right).....
1402D	1894	" " " " Screw.....
11442	22435	" " Friction Washer (paper)..
401E	1894	" " " " Screw.....
354C	1895	" " Set Screw.....
8934	22433	Brake Block (wood).....
58458	22433	" " Stud.....
1036C	22409	" " " " Screw.....
11440	22441	Friction Pulley, 7 in. diam., 1 1/2 in. face, with 448C and 11441.....
11441	22409	Friction Pulley Center Bearing.....
448C	1896	" " Set Screw.....
122428	22442	Lever with 1036C.....
122358	22437	" Bracket.....
3012	1894	" " Dowel Pin.....
116E	22409	" " Screw.....
135D	22410	" Screw.....
8991	22433	" Washer.....
8992	22433	" Spring.....
122363	22433	" " Hook.....
1520J	22410	" " " Nut.....
6055	22410	" " " Washer.....
166D	22401	" " Screw.....
11864	22434	Shaft Driving Pulley (sectional) 10 in. diam., 1 1/4 in. face, 1 3/16 in. bore, with two 597C.....
597C	22410	Shaft Driving Pulley Clamping Screw....
14672	22441	Treadle (wood).....
14673	22433	" Eyelet.....
342E	22410	" " Screw.....
9842	1894	" " " Washer.....
14674	22433	" Hinge.....
14706	-----	Treadle complete, Nos. 342E, 9842, 14672 to 14674, 14708 and six wood screws 1 1/4 in. No. 10.....
27639	22438	Treadle Pitman Rod (lower).....
14707	22436	" " " (upper).....
80223	22438	" " " Clamp with 361C.....
361C	22410	" " " " Screw.....
14708	22436	Treadle Pitman complete, Nos. 14707, 27639 and 80223.....
122434	-----	Driving Attachment complete, Nos. 135D, 166D, 1520J, 6055, 8934, 8991, 8992, 11440, 11864, 14706, 58458, 122302, 122304, 122306, 122358, 122363, 122428 and two 116E.....

DRIVING ATTACHMENT

FOR

II-34 MACHINE

No.	Plate	Name
122315	22435	Balance Wheel with two 354C.....
122318	-----	" " 122315 with 11442, 122469, two 1402D and four 401E.....
25362	1894	Balance Wheel Ball, size 3/16 in.....
122317	-----	" " " Ring (brass).....
122318	22419	" " " " 122317 with eighteen 25362.....
122319	22417	Balance Wheel Ball Washer (left).....
122489	22419	" " " " (right).....
1402D	1894	" " " " " Screw.
11442	22435	" " " Friction Washer (paper)..
401E	1894	" " " " " Screw....
354C	1895	" " " Set Screw.....
8984	22433	Brake Block (wood).....
58458	22433	" " Stud.....
1036C	22409	" " " Screw.....
11440	22441	Friction Pulley, 7 in. diam., 1 1/2 in. face with 448C and 11441.....
11441	22409	Friction Pulley Center Bearing.....
448C	1896	" " " Set Screw.....
122428	22442	Lever with 1036C.....
122446	-----	" 122428 with 135D, 8984, 8991, 8992, 58458, 122427 and two 123E.....
122427	22438	Lever Bracket.....
2117	1894	" " Dowel Pin.....
123E	22403	" " Screw.....
135D	22410	" " Screw.....
8991	22433	" " Washer.....
8992	22433	" " Spring.....
14785	22433	" " Hook.....
1520J	22410	" " " Nut.....
6055	22410	" " " Washer.....
186D	22401	" " " Screw.....
11864	22434	Shaft Driving Pulley (sectional) 10 in. diam., 1 1/4 in. face, 1 3/16 in. bore with two 597C.....
597C	22410	Shaft Driving Pulley Clamping Screw....
126038	22438	Treadle.....
126037	-----	" 126038 with 2718R, 50581R and 126038.....
126205	22438	Treadle Bracket (left).....
126206	-----	Treadle Bracket (left) complete, Nos. 23258, 126205, 126207, 126208 and two wood screws 1 in. No. 14.....
126207	22433	Treadle Bracket (left) Hook.....
23258	22410	" " " " Friction Washer.....

DRIVING ATTACHMENT

33

No.	Plate	Name
126208	22410	Treadle Bracket (left) Hook Rivet.....
46681	22438	" " " (right).....
60502	-----	" " " 46681 with two wood screws 1 in. No. 14.....
126211	-----	Treadle complete, Nos. 60502, 126037 and 126206.....
126038	22438	Treadle Extension.....
50581R	22410	" " " Screw.....
2718R	22402	" " " Washer.....
60858	22433	" " Hanging Hook.....
60826	22438	Treadle Pitman complete, Nos. 80223 and two 27639.....
27639	22438	Treadle Pitman Rod (lower).....
27639	22438	" " " (upper).....
80223	22438	" " " Clamp with 361C.....
361C	22410	" " " " Screw.....
126212	-----	Treadle and Pitman complete, Nos. 60826, 60858 and 126211.....
122433	-----	Driving Attachment complete, Nos. 166D, 1520J, 6055, 11440, 11864, 14785, 122316, 122318, 122319, 122446 and 126212.....

DRIVING ATTACHMENT

FOR

II-35 MACHINE

SAME AS NO. 122433 WITH THE FOLLOWING EXCEPTIONS:

No.	Plate	Name
122426	22442	Lever with 1036C, in place of 122428...
3012	1894	" Bracket Dowel Pin, in place of 2117.....
122363	22433	Lever Spring Hook, in place of 14785...
122435	-----	Driving Attachment complete, Nos. 135D, 166D, 1520J, 6055, 8984, 8991, 8992, 11440, 11864, 58458, 122316, 122318, 122319, 122363, 122426, 122427, 126212 and two 123E, in place of 122434..

FOOT LIFTER PARTS

FOR

II-34 MACHINE

No.	Plate	Name
13351	-----	Chain, 46 in. to 55 in. long, with 56864 and 56865.....

Note: When ordering No. 13351 give length required.

FOOT LIFTER PARTS

No.	Plate	Name
4879	22433	Chain Connecting Link.....
56864	22433	" Hook (large).....
56865	22433	" " (small).....
122385	22436	Lifting Lever.....
58D	22401	" " Hinge Screw.....
122386	22433	" " Link.....
76D	22410	" " " Hinge Screw.....
19510	22410	" " Spring.....
86D	22410	" " " Screw.....
8999	22410	" " Stop Pin.....
4881	22438	Treadle.....
4882	22433	" Shaft.....
4883	22428	" Spring.....
4884	22438	" Stand.....
4885	22438	Treadle complete, Nos. 4879, 4881 to 4884 and two wood screws 1 in. No. 16..
122384	22430	Vibrating Presser Bar Hinge Bracket with 145F.....
145F	1895	Vibrating Presser Bar Hinge Bracket Ad- justing Screw.....
76D	22410	Vibrating Presser Bar Hinge Bracket Lifting Screw.....
122387	-----	Foot Lifter complete, Nos. 58D, 4885, 8999, 13351, 19510, 122385, 122386, two each 76D and 86D.....

**Genuine Singer Needles should be used
in Singer Machines.
These Needles and their Containers
are marked with the
Company's Trade Mark "SIMANCO." 1**

**Needles in Containers marked
"For Singer Machines"
are not Singer made needles. 2**

PLATE 1894 - FULL SIZE

19785



43263



3012



144



445



437



9842



446



434



65



2117



453



25362



401



1402



11241



PLATE 1895 - FULL SIZE

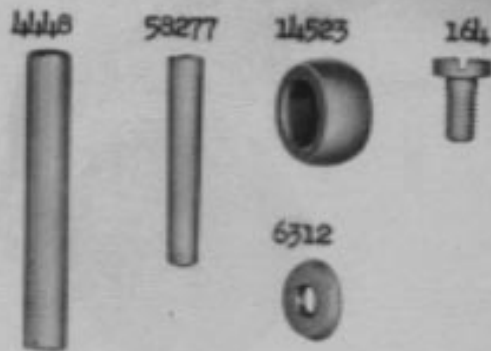
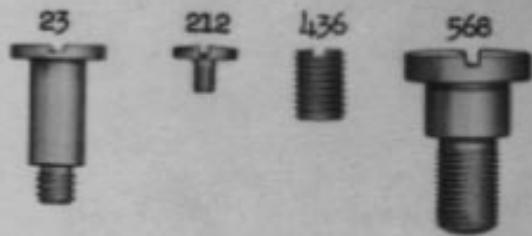
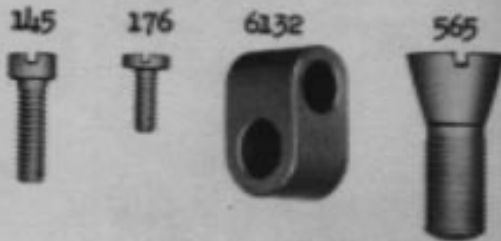


PLATE 1896 - FULL SIZE

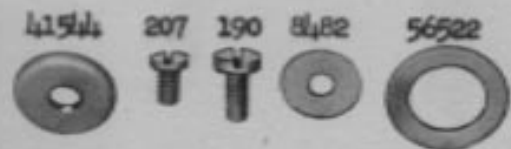
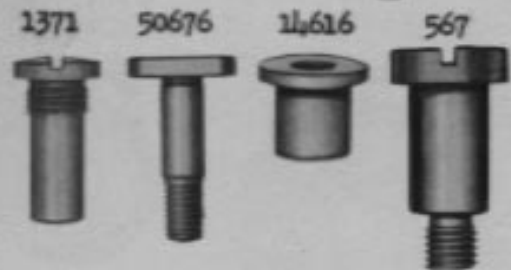
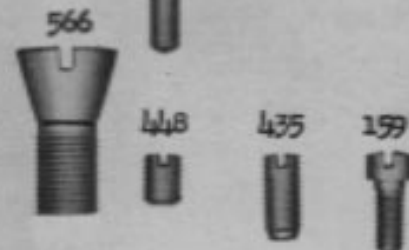
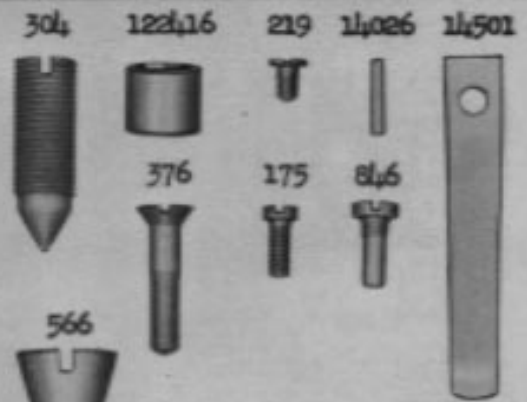


PLATE 1897 - FULL SIZE

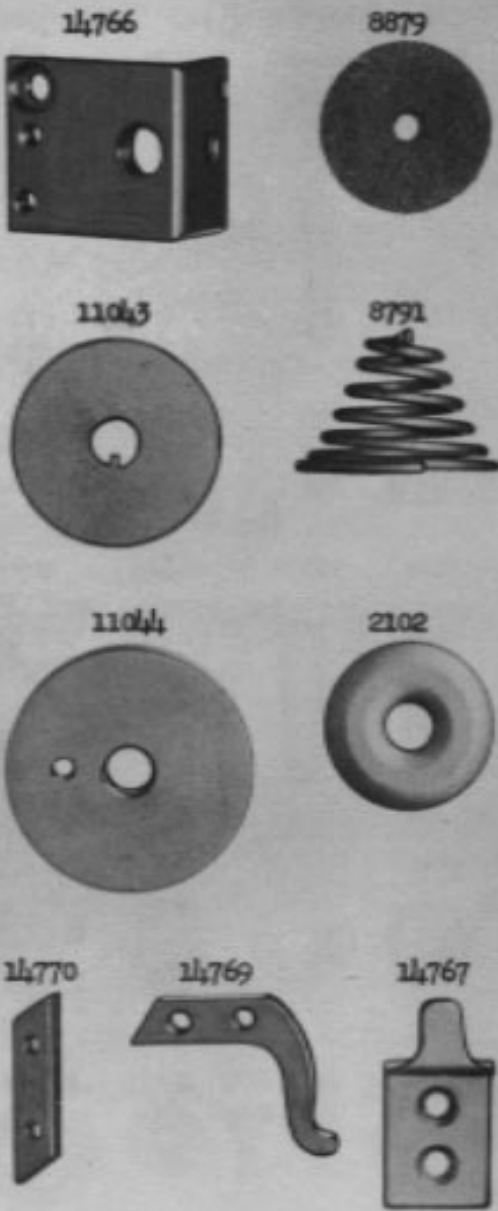


PLATE 1898 - FULL SIZE



PLATE 1899 - FULL SIZE

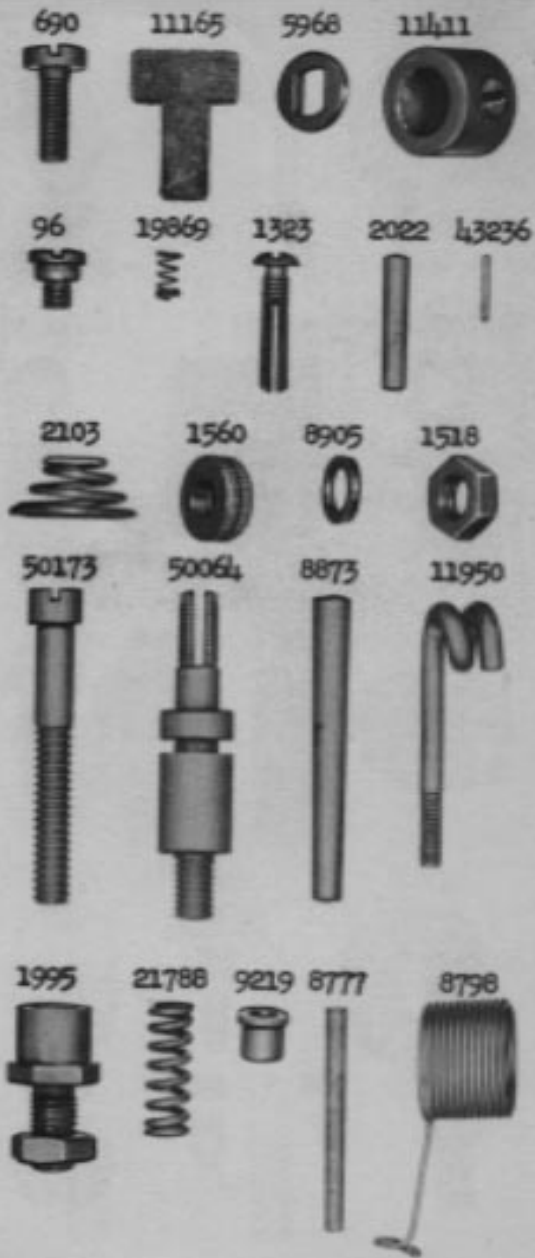


PLATE 2240I - FULL SIZE

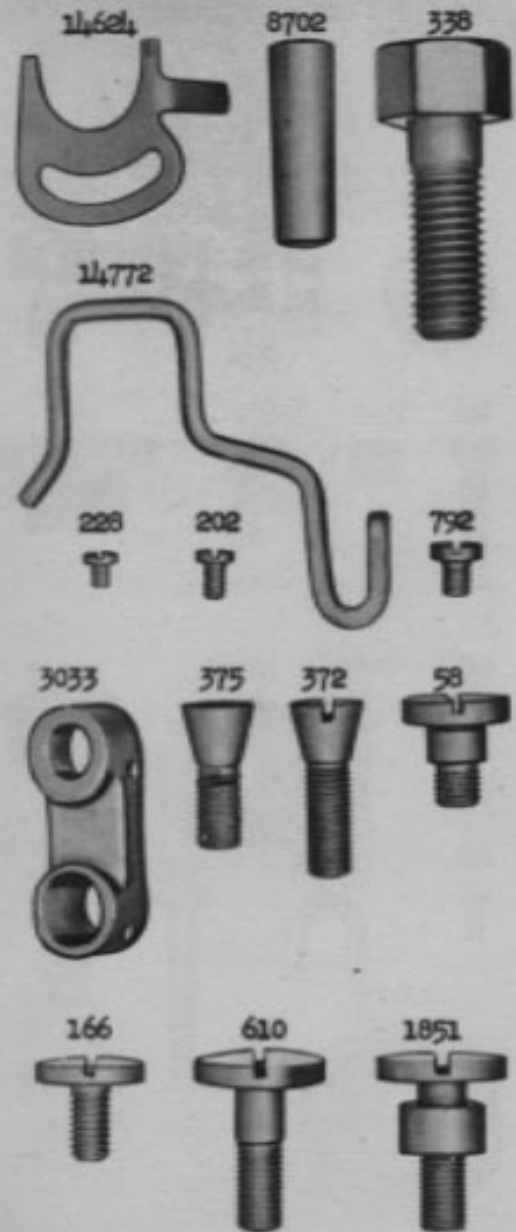


PLATE 22402 - FULL SIZE



PLATE 22403 - FULL SIZE

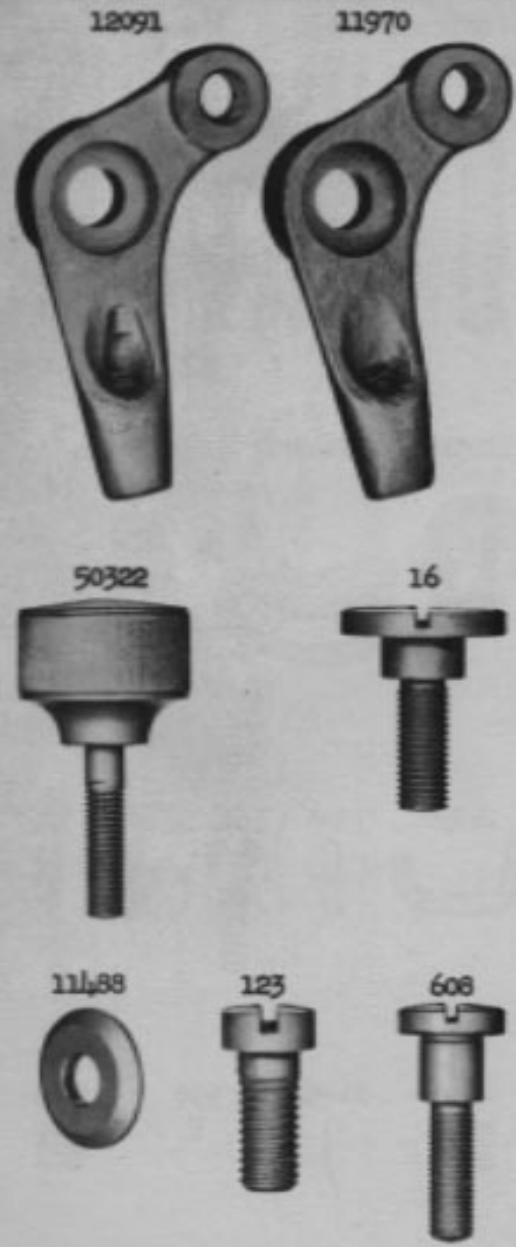


PLATE 22404 - FULL SIZE

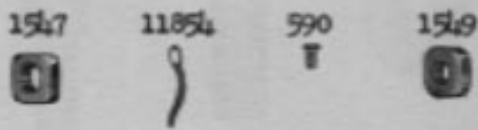
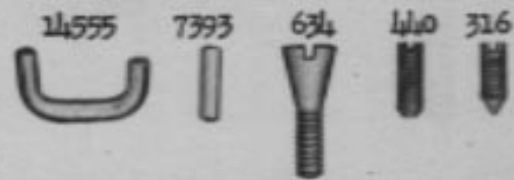
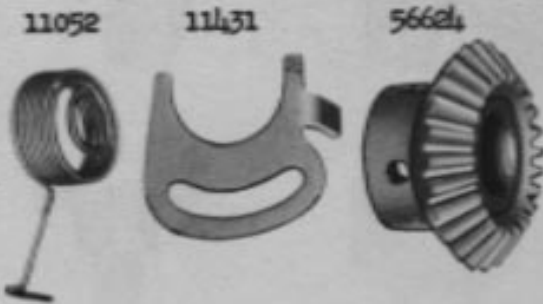
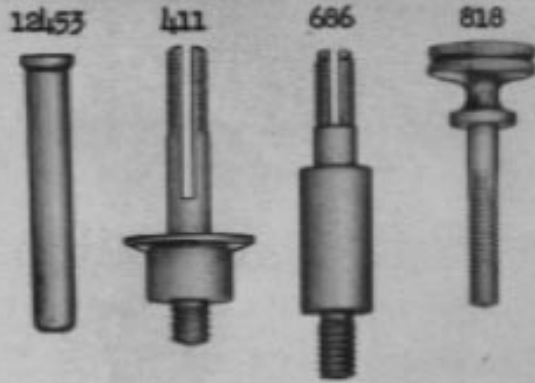


PLATE 22405 - FULL SIZE

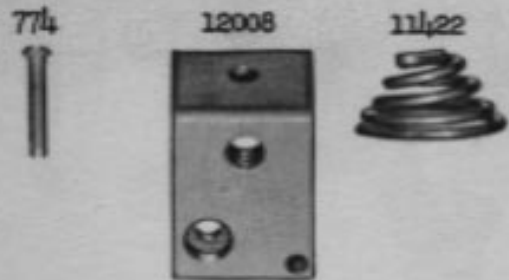
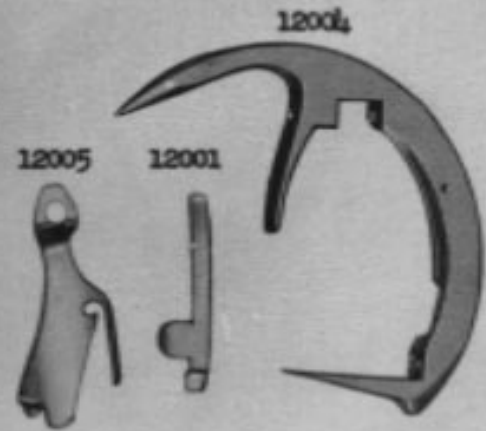


PLATE 22406 - FULL SIZE

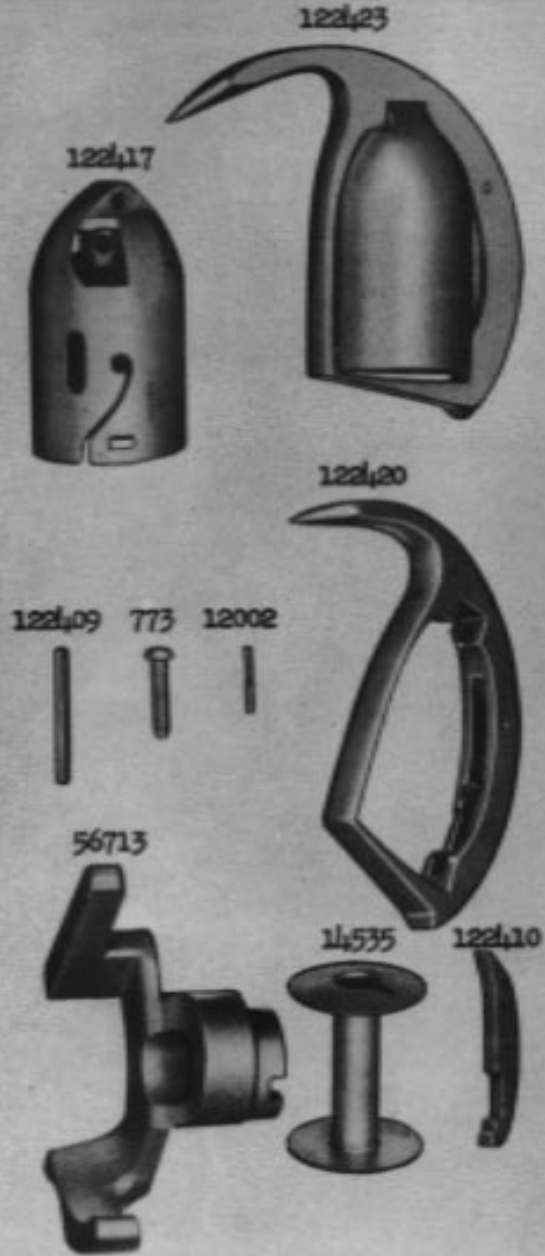


PLATE 22407 - FULL SIZE

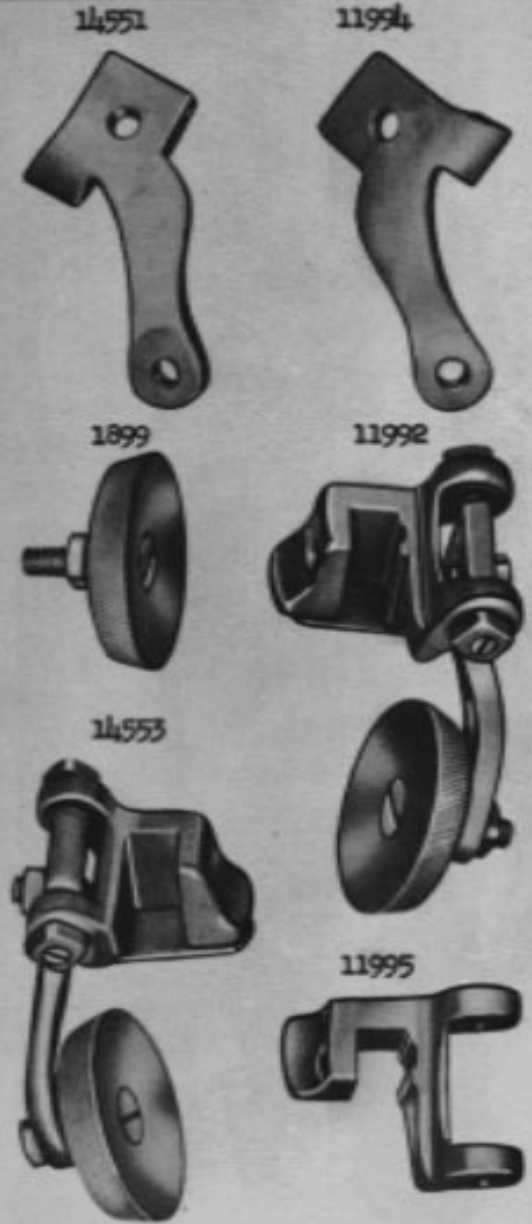


PLATE 22408 - FULL SIZE

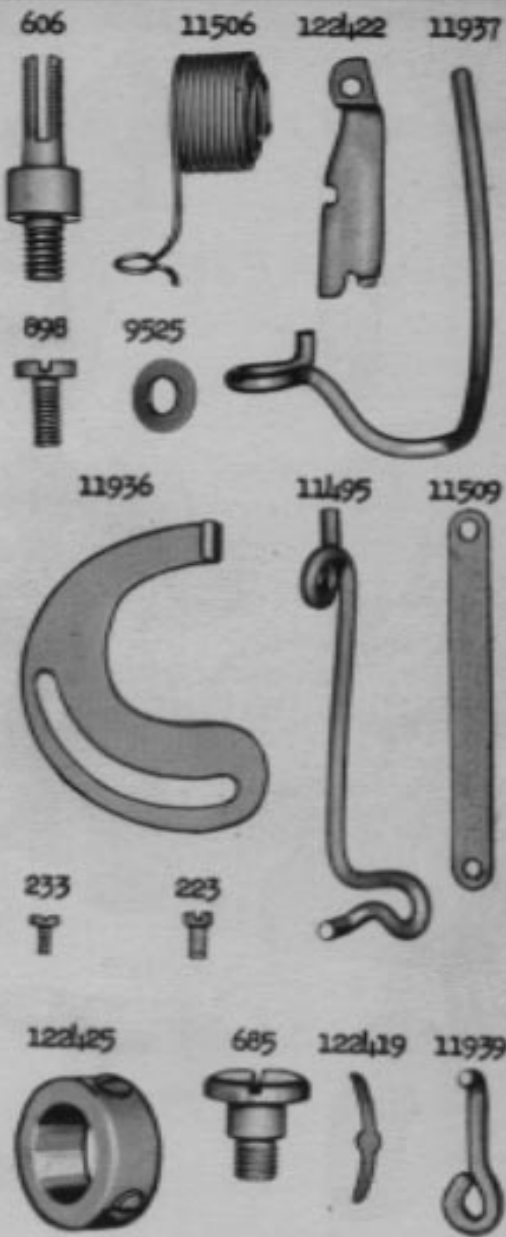


PLATE 22409 - FULL SIZE

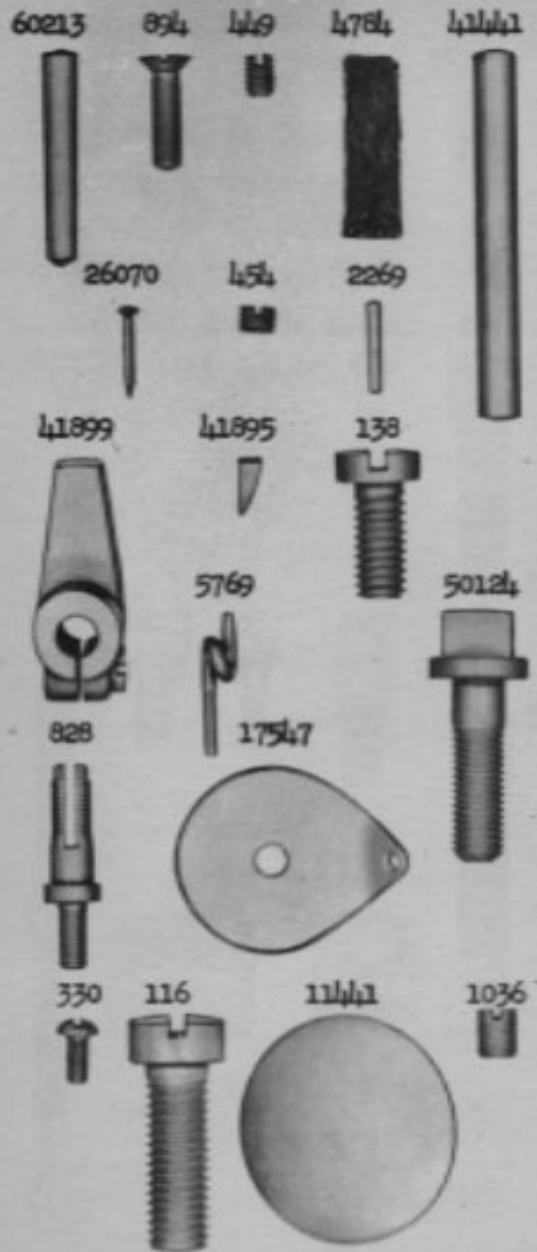


PLATE 22410 - FULL SIZE

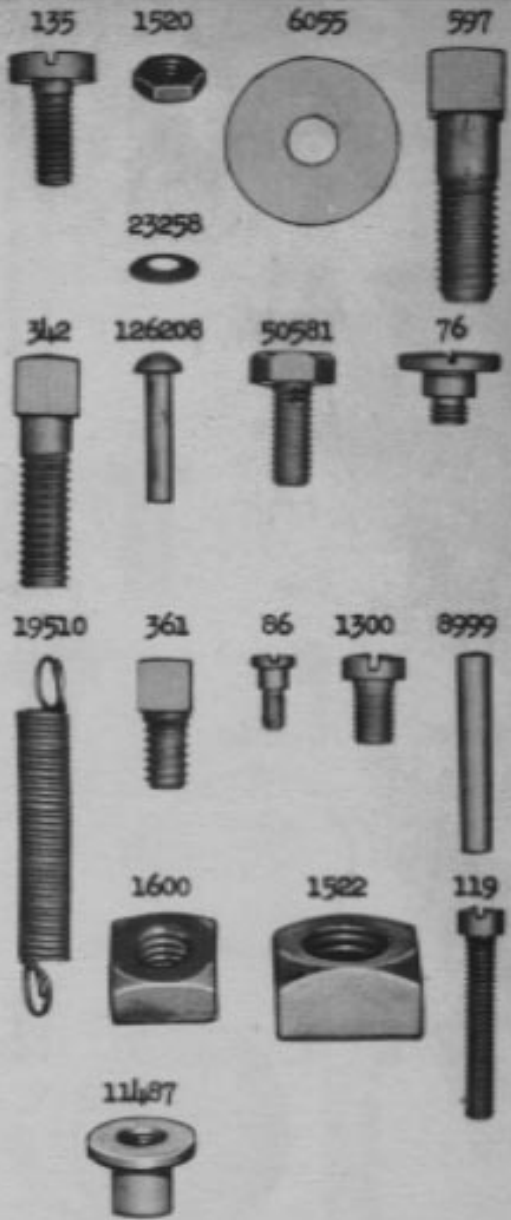


PLATE 22411 - FULL SIZE

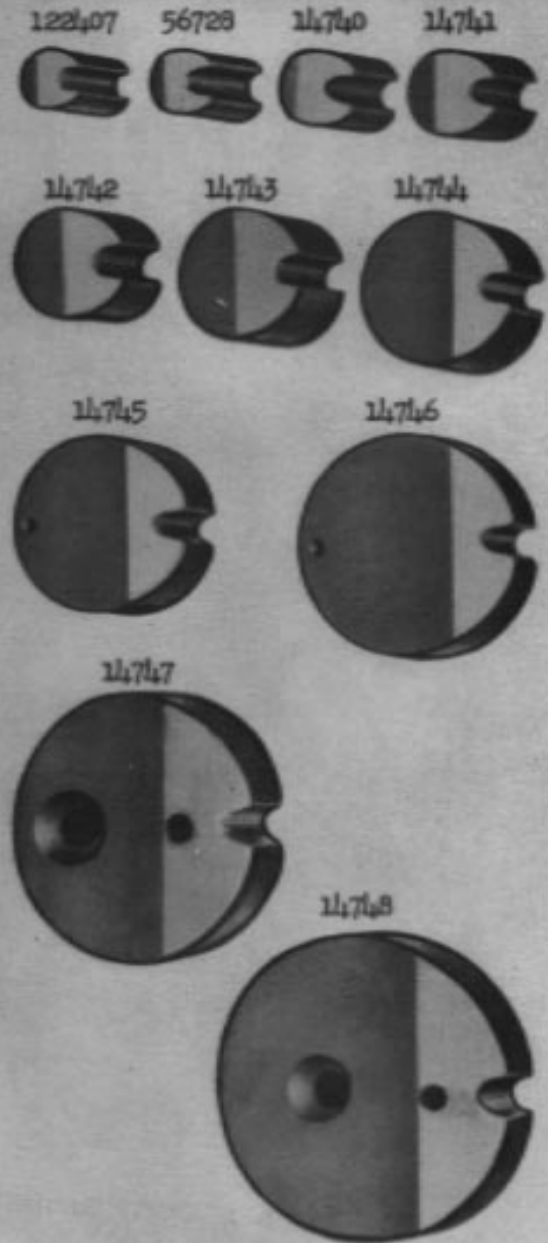


PLATE 22412 - ONE - HALF SIZE

14755



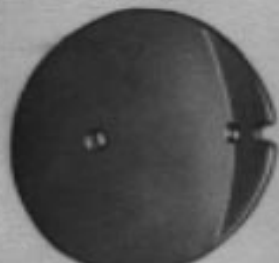
14749



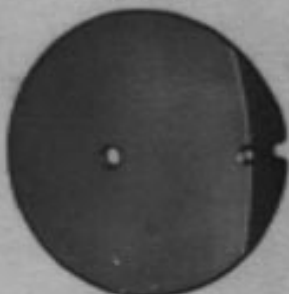
14750



14753



14754



14752



14756

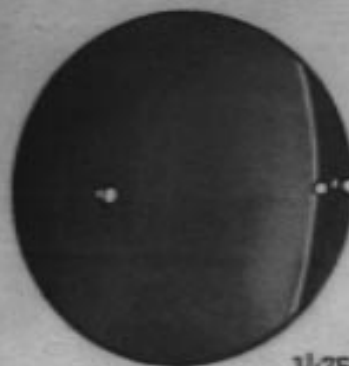


14751

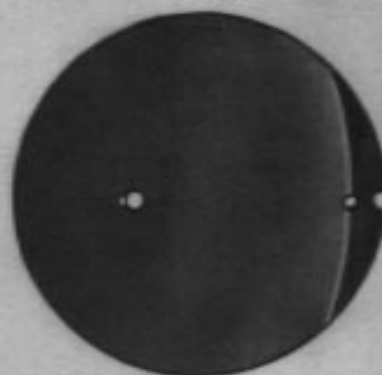


PLATE 22413 - ONE - HALF SIZE

14757



14758



14759

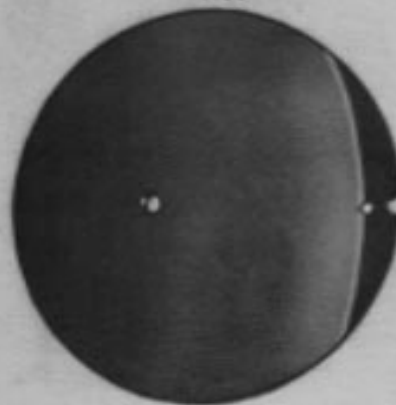


PLATE 22414 - ONE - HALF SIZE

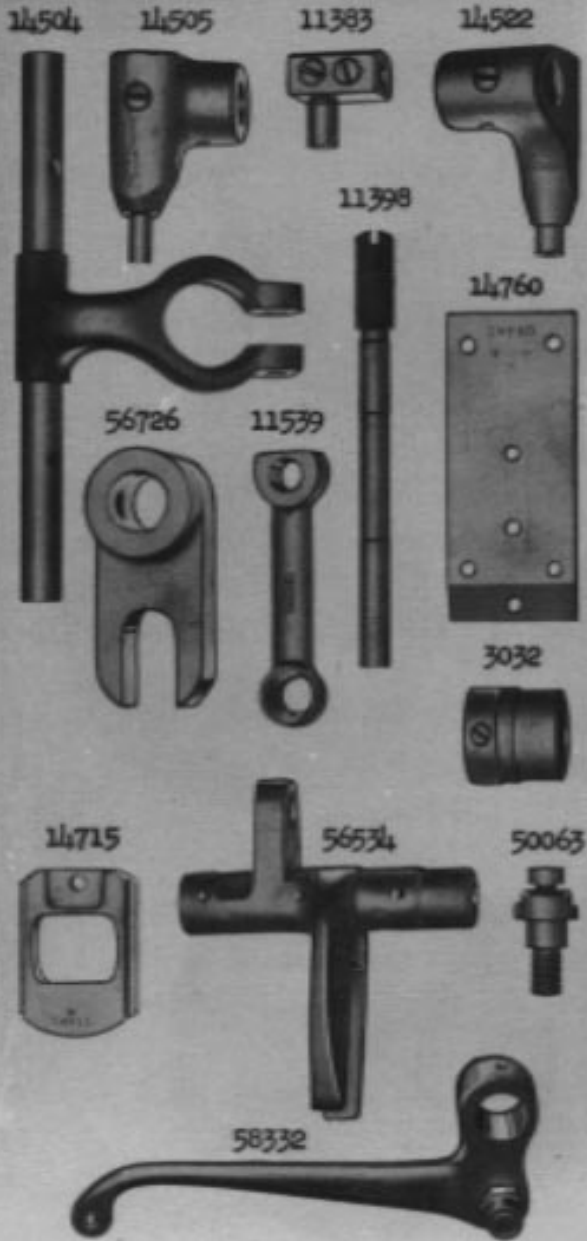


PLATE 22415 - ONE - HALF SIZE

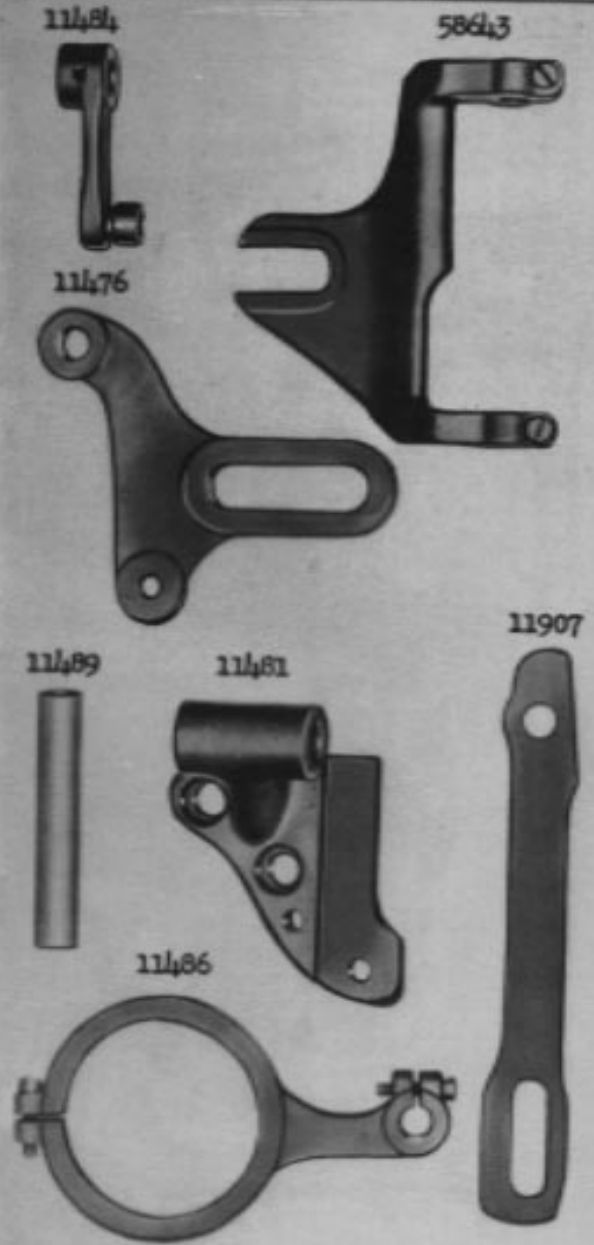


PLATE 22416 - ONE - HALF SIZE

11490



58252



12090



11164



122381



12088



14633



11502



607



11479



58296



50437



PLATE 22417 - ONE - HALF SIZE

14603



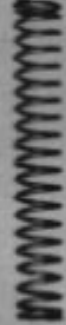
11475



11986



11991



6805



122372



14631



58578



122319

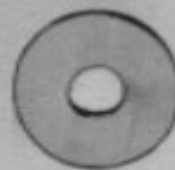


PLATE 22418 - ONE - HALF SIZE

56739



56740



632



122314



17429



17430



PLATE 22419 - ONE - HALF SIZE

11354



56536



56537



114607



122328



8708



50346



122304



254



122306



122469



122318



114583



11368



PLATE 22420 - ONE - HALF SIZE

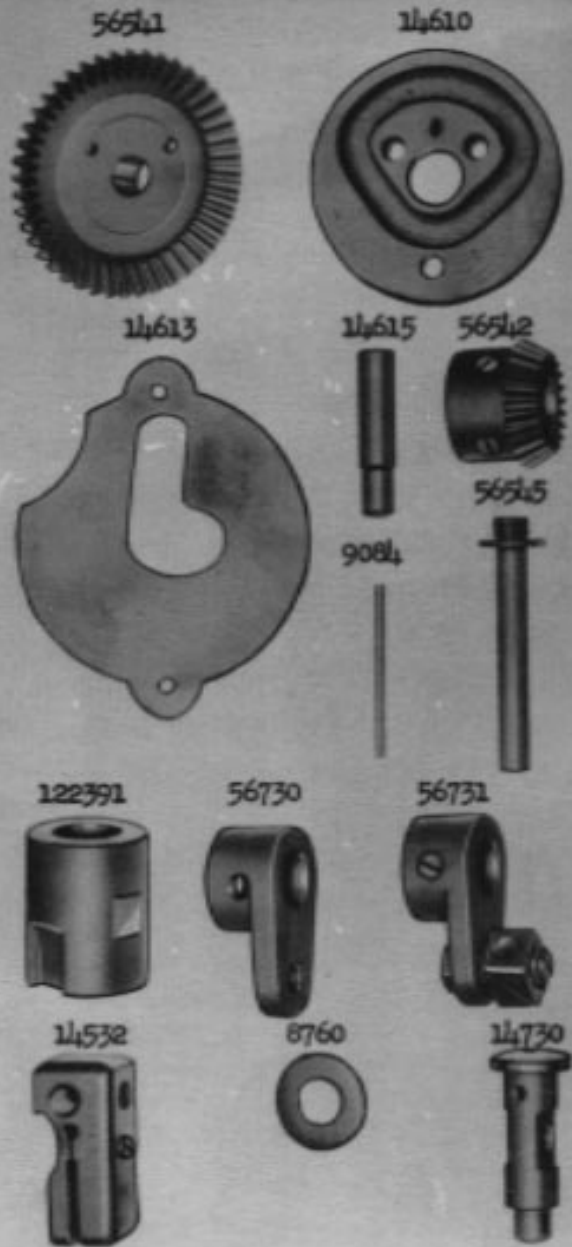


PLATE 22421 - ONE - HALF SIZE

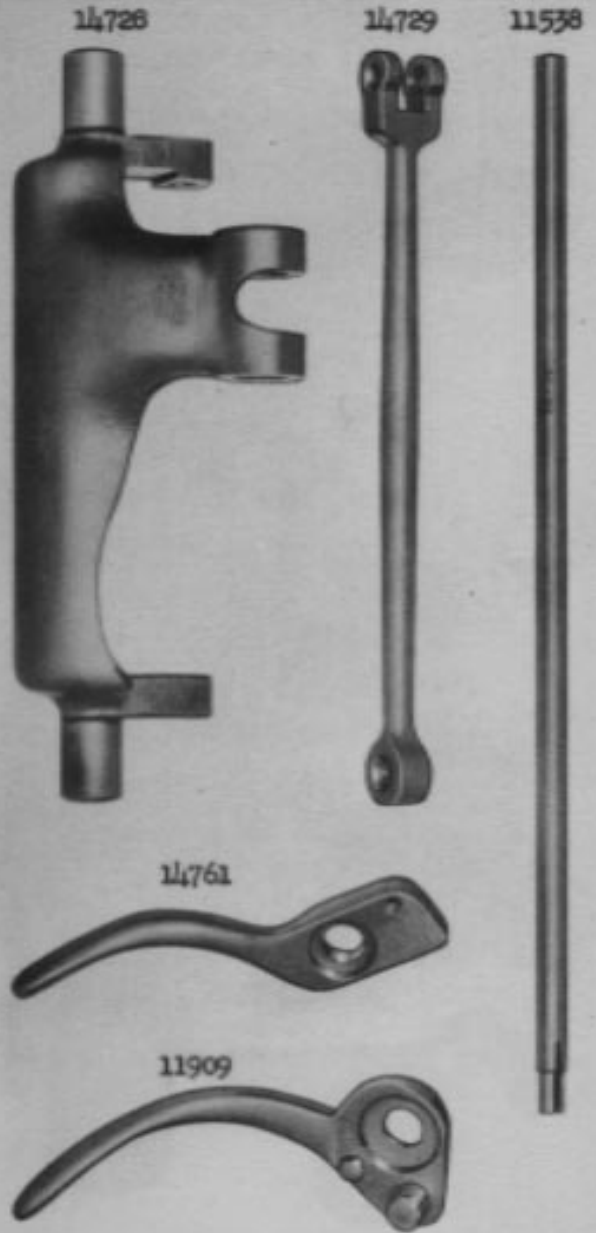


PLATE 22422 - ONE - HALF SIZE

16901



56737



56736 43239



56735



11367



56738

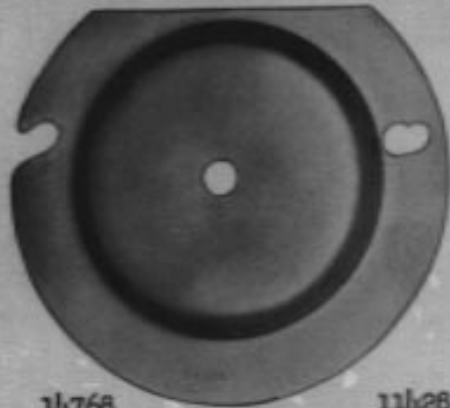


56734



PLATE 22423 - ONE - HALF SIZE

32885



14768



11428



14617



12044



PLATE 22424 - ONE - HALF SIZE

56717



56720



56718



56721



56722



14762



14763



56732



56733



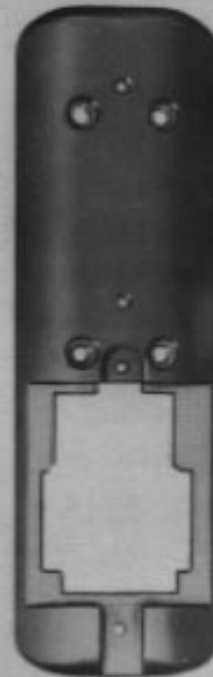
PLATE 22425 - ONE - HALF SIZE

56719



56719

56711



56715



56713



56723

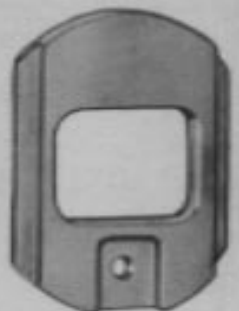
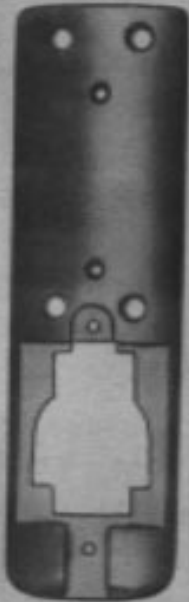


PLATE 22426 - ONE - HALF SIZE

114519



114520



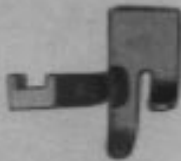
114574



114716



114680



114661



114570



114559



114733



PLATE 22427 - ONE - HALF SIZE

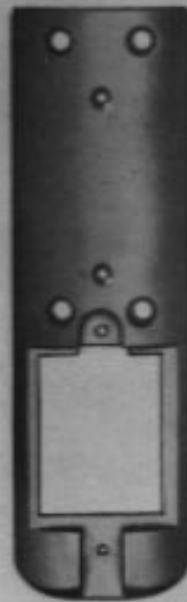
114554



122332



114783



56608



56602



56610



19951



PLATE 22428 - ONE - HALF SIZE



PLATE 22429 - ONE - HALF SIZE



PLATE 22430 - ONE - HALF SIZE

56609



11512



122384

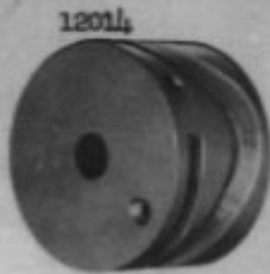
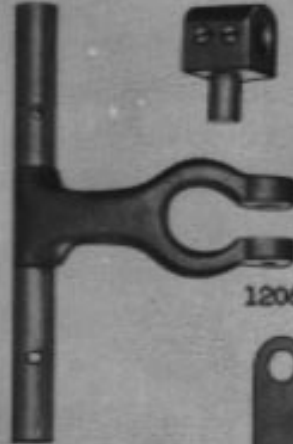


PLATE 22431 - ONE - HALF SIZE

11565



11547



56707



12066



11975



11988



122430



122431



11976



11990



56613

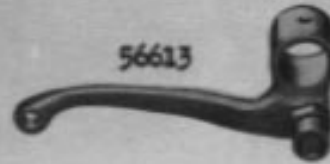


PLATE 22432 - ONE - HALF SIZE

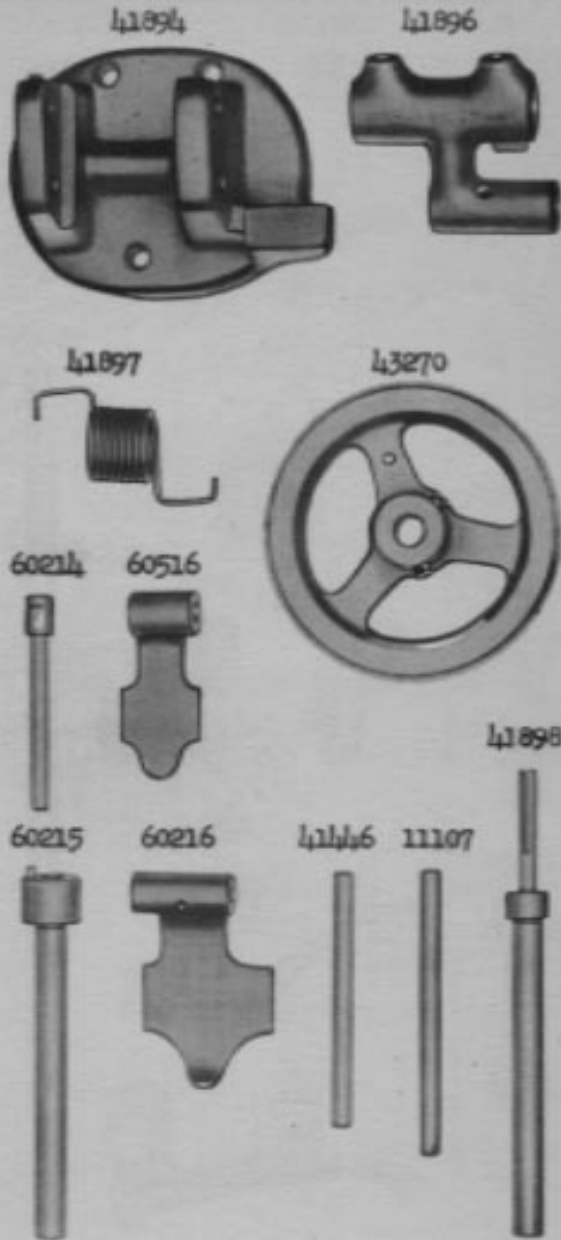


PLATE 22433 - ONE - HALF SIZE

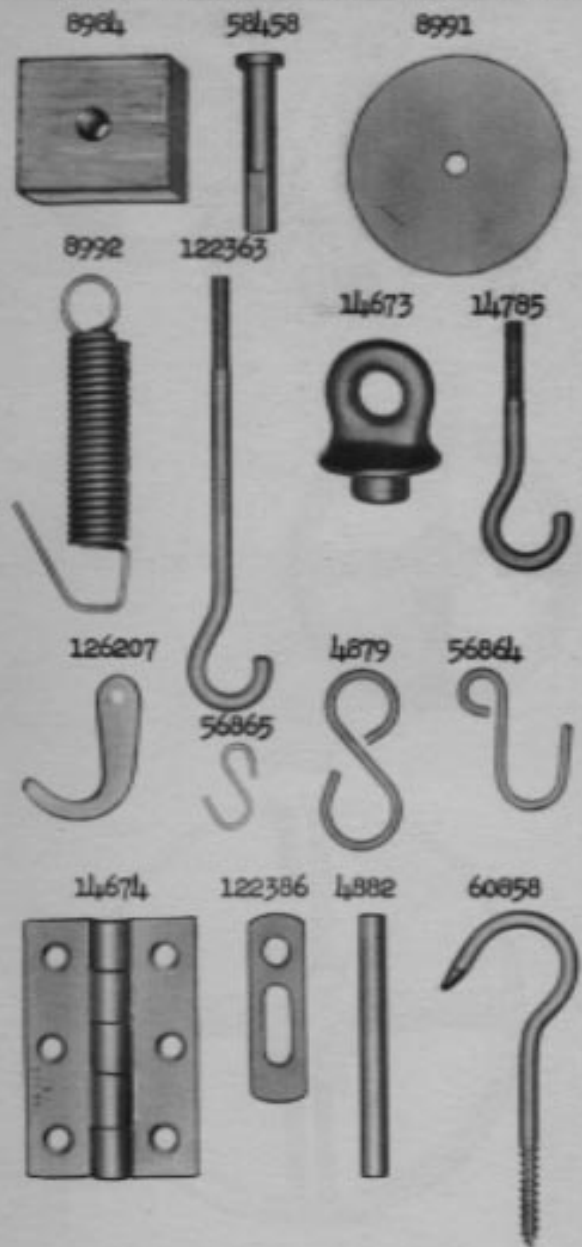


PLATE 22434 - ONE - FOURTH SIZE

14578



11957



14579



14710



11864



PLATE 22435 - ONE - FOURTH SIZE

122301



11442



122315



PLATE 22436 - ONE - FOURTH SIZE

122424 122383 114566 122385 11493 114708

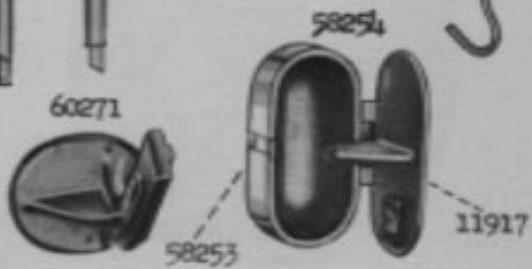
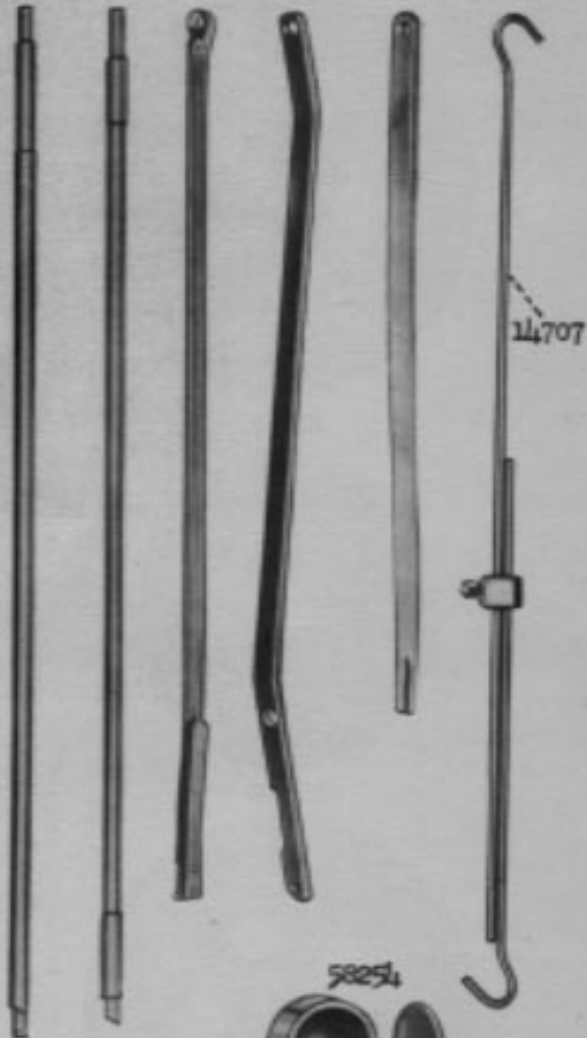


PLATE 22437 - ONE - FOURTH SIZE

12087 114545 56724 12097 12062

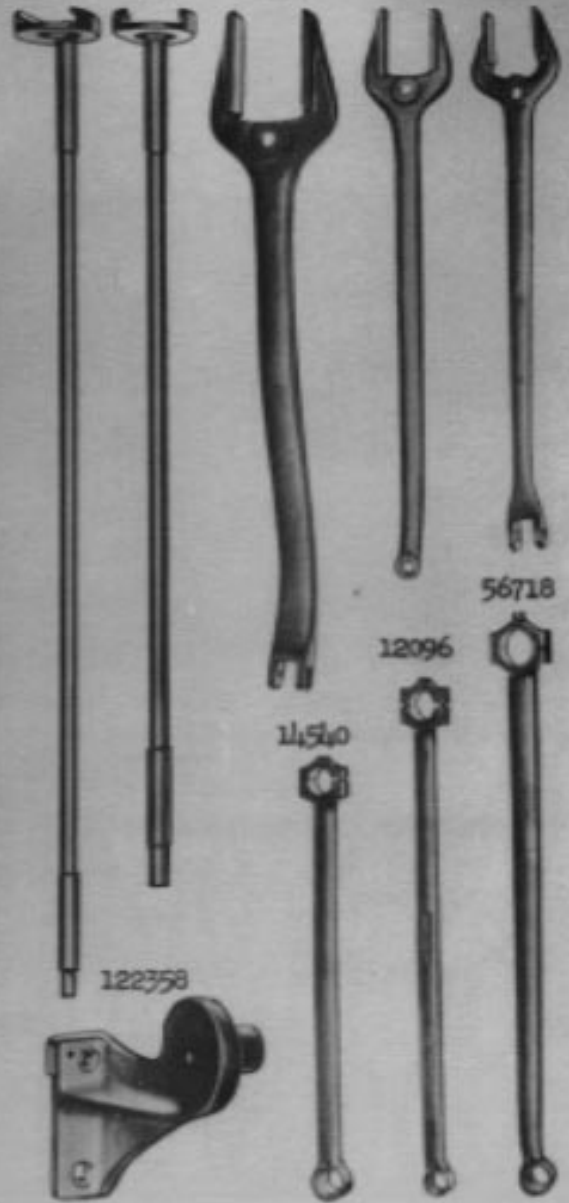


PLATE 22438 - ONE - FOURTH SIZE

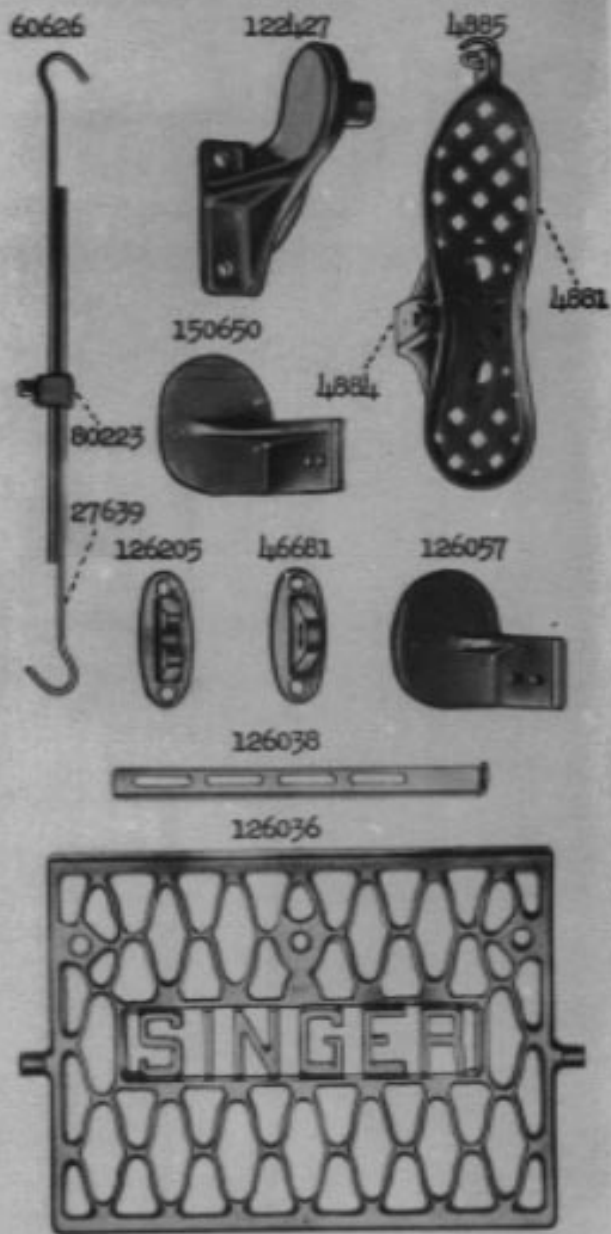


PLATE 22439 - ONE - FOURTH SIZE

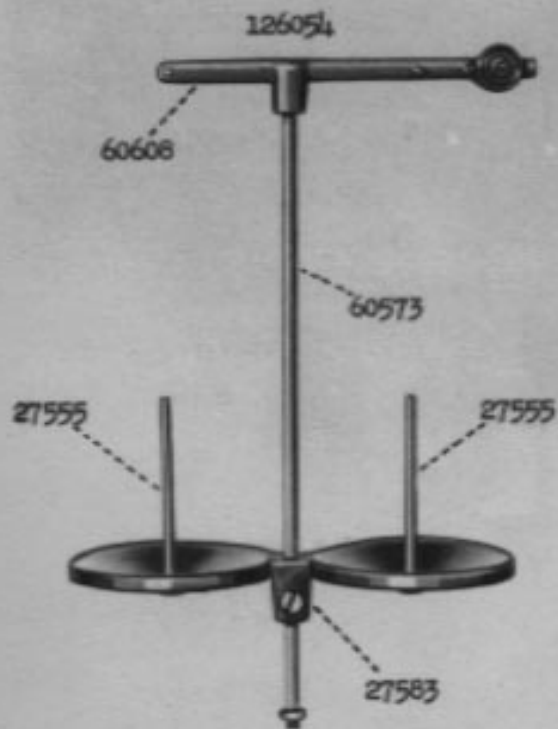


PLATE 22440 - ONE - FOURTH SIZE

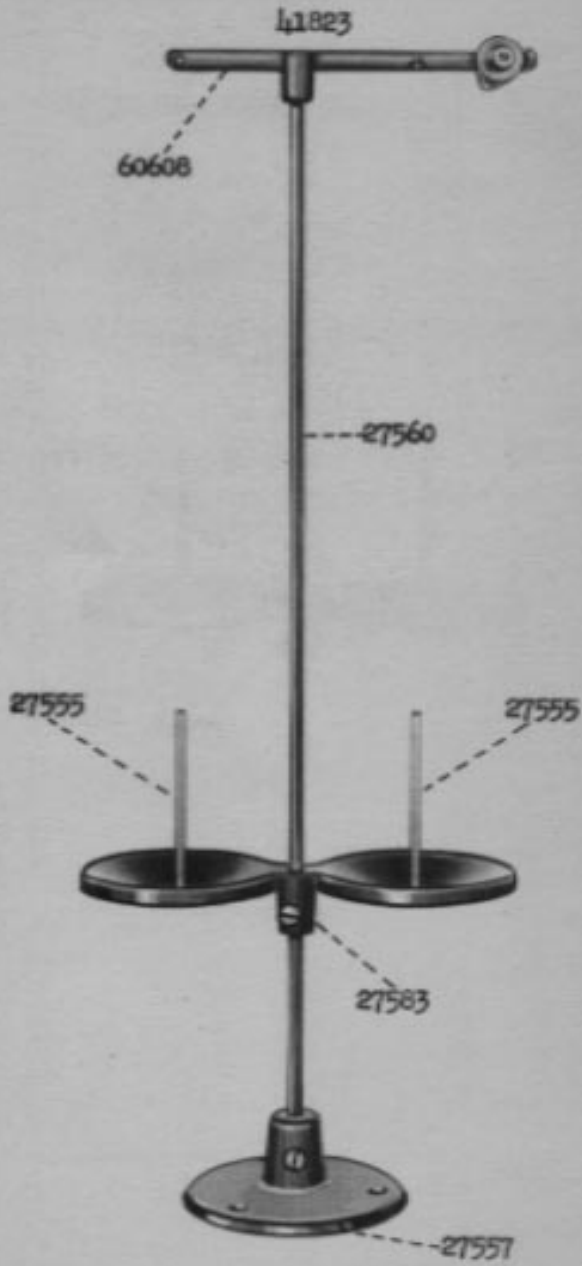


PLATE 22441 - ONE - SIXTH SIZE

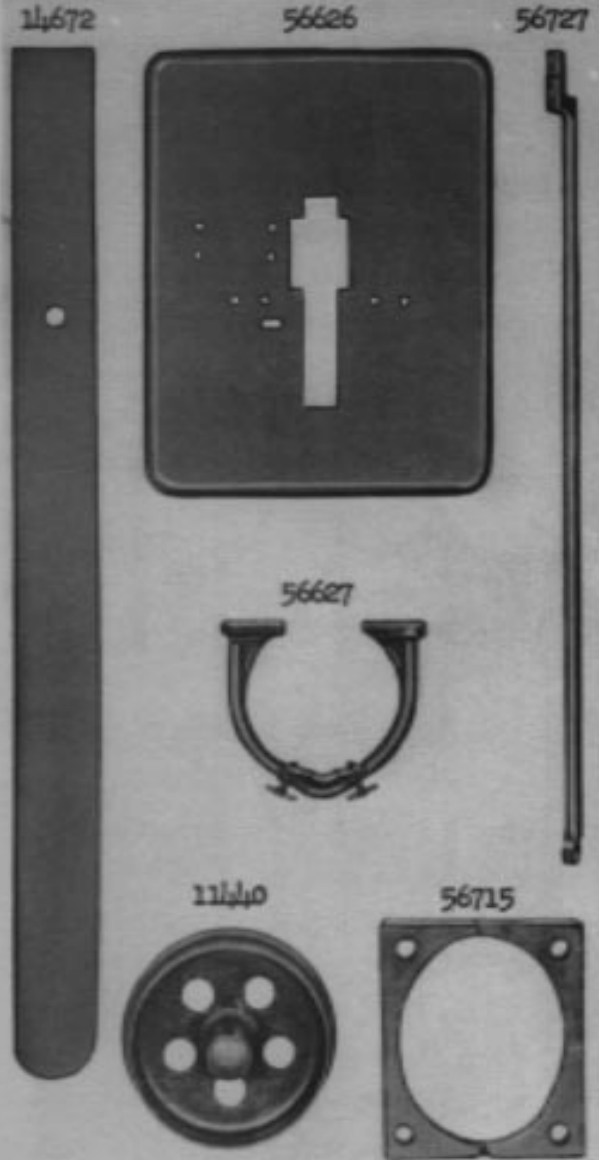
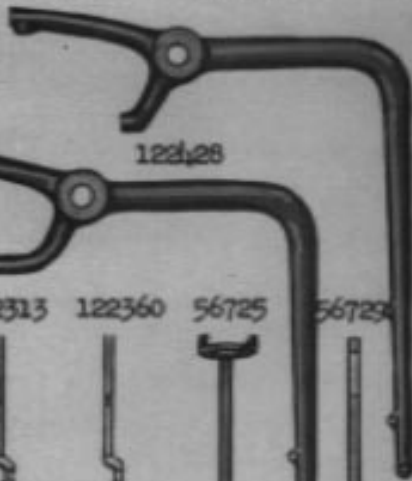
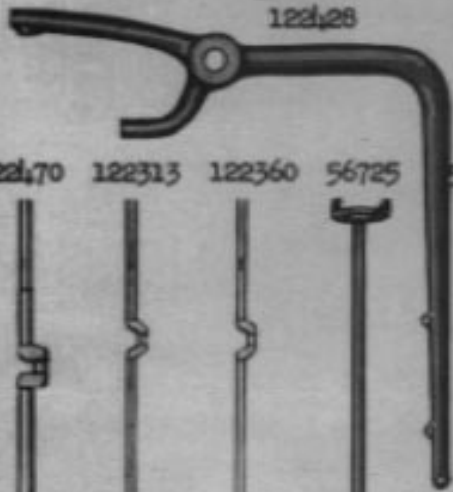


PLATE 22442 - ONE - NINTH SIZE

122426



122428



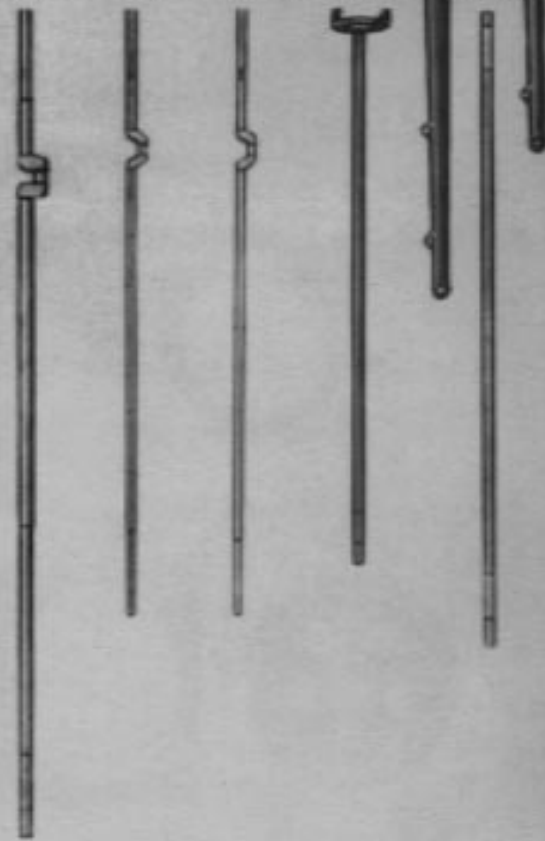
122470

122313

122360

56725

56729



Genuine Singer Needles should be used
in Singer Machines.
These Needles and their Containers
are marked with the
Company's Trade Mark "SIMANCO." 1

Needles in Containers marked
"For Singer Machines"
are not Singer-made needles. 2