

Form 18415
February, 1930
PRINTED IN U. S. A.

LIST OF PARTS



MACHINES

Nos. 117-3 and 117-4

THE SINGER MANUFACTURING COMPANY

COPYRIGHT, U. S. A., 1921, 1922, 1923, 1925, 1928 AND 1930
BY THE SINGER MANUFACTURING CO.
ALL RIGHTS RESERVED FOR ALL COUNTRIES

INDEX

	PAGE
ACCESSORIES	36
FOOT LIFTER CHAIN GUIDE	37
“ “ PARTS	36
IRON BASE	36
MACHINE NO. 117-3	7
“ “ 117-4	22
NUMERICAL LIST OF PARTS	41
TABLE SUPPORT PARTS	37
THREAD NIPPER TIMING GAUGE	37
“ UNWINDER	37
UNDER DRIVER	38

INSTRUCTIONS FOR ORDERING

In ordering from this list, use ONLY the part NUMBER in the FIRST column.

The number stamped on a Sewing Machine part is in every case the number of the single part only.

Every combination of parts sent out as such has its specific number, which, although not stamped on the parts, must be used when ordering the combination.

Each number always indicates the SAME PART in whatever list it appears, or for whatever machine.

The letters after some of the numbers indicate the style of finish only, as follows:

- A—Hardened, Polished, Nickel Plated and Buffed
- B—Polished, Nickel Plated and Buffed
- C—Hardened Only
- D—Polished Only
- E—Soft, Not Polished
- F—Hardened and Polished
- H—Blued
- J—Nickel Plated Only
- K—Hardened and Nickel Plated
- L—Brass Plated
- M—Oxidized
- N—Japanned, Dull
- P—Japanned, Bright
- R—Merlized
- T—Copper Plated
- T. A.—Hardened, Polished, Copper and Nickel Plated and Buffed.
- T. B.—Copper and Nickel Plated and Polished.
- T. J.—Copper and Nickel Plated Only.
- T. K.—Hardened, Copper and Nickel Plated.
- T. M.—Copper Plated and Oxidized.
- T. L.—Copper and Brass Plated.
- U—Zinc Plated
- V—Silver Plated
- W—Polished and Nickel Plated
- Z—Chromium Plated
- Z. B.—Polished, Nickel Plated, Buffed and Chromium Plated
- Z. J.—Nickel and Chromium Plated.

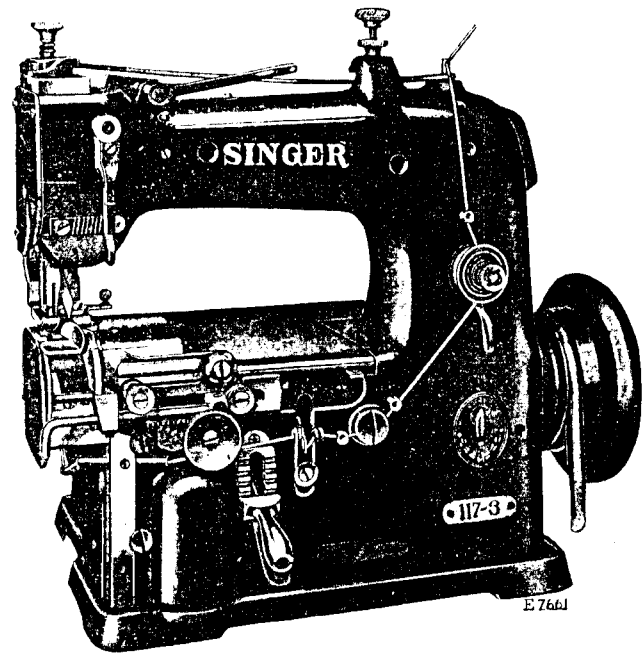
These letters MUST BE USED when they appear in the list; and AFTER the number as in the list.

In this series:
1 to 1500 and 50001 to 51500 are Screw Numbers.
1501 to 1800 and 51501 to 51800 are Nut Numbers.
1801 to 2000 and 51801 to 52000 are Roller Numbers.
2001 to 50000 and 52001 and upward are numbers of Machine Parts.

The figures in the second column refer only to the plates, illustrating the parts, and are NOT TO BE USED in ordering.

Parts marked with an asterisk (*) are furnished only when repairs are made at factory.

LIST OF PARTS COMPLETE FOR



MACHINE No. 117-3

FOR STITCHING STRAW HATS WITH A CONCEALED STITCH. ONE NEEDLE, ONE HOOK EYE NEEDLE. POSITIVE SET FOR REGULATION OF LENGTH OF STITCH. LENGTH OF STITCH $\frac{1}{16}$ TO $\frac{5}{8}$ INCH. THE MACHINE IS FITTED WITH A THREAD NIPPER RELEASER AND LOOP SPREADER; ALSO A HINGED COVER TO THROW BACK, FOR THE CONVENIENCE OF REACHING THE LOWER PARTS OF THE MACHINE.

SUPERSEDES 117-2 MACHINE

NO.	PLATE	NAME
*64765	—	Arm, upper and lower (solid) with 64772, two each 50012c, 64773 and four 50128e
64751	8475	Arm End Cover (back).....
219d	8494	“ “ “ “ Screw.....
64766	8475	“ “ “ (front).....
330d	8495	“ “ “ “ Screw.....
56003	8484	“ Oil Tube with 52045.....

NO.	PLATE	NAME
52045	9804	Arm Oil Tube Packing (felt).....
65914	8475	“ Rotary Shaft.....
64505	8476	“ “ “ Bushing (front).....
453c	8494	“ “ “ “ “ S e t Screw.....
65915	8476	Arm Rotary Shaft Bushing (intermediate) Eccentric.....
1299c	9804	Arm Rotary Shaft Bushing (intermediate) Eccentric Set Screw.....
32152	8476	Arm Rotary Shaft Collar with two 889c. 889c 8494 “ “ “ “ Set Screw.....
64507	8475	“ “ “ Flanged Bushing (back) with 64508.....
64508	8482	Arm Rotary Shaft Flanged Bushing (back) Oil Pad (braided cotton).....
159f	8473	Arm Rotary Shaft Flanged Bushing (back) Screw.....
64509	8475	Arm Side Cover.....
219d	8494	“ “ “ Screw.....
64510	8475	Balance Wheel, 3 in. pulley, with two 448c. 448c 8494 “ “ Set Screw.....
64768	8475	Face Plate.....
219d	8494	“ “ Screw.....
64769	8475	Feed Bar.....
64770	8482	“ “ Carrier with 453c.....
64516	8482	“ “ “ Hinge Pin.....
64517	8476	“ “ “ “ “ Bushing.....
446c	8494	“ “ “ “ “ “ Set Screw.....
453c	8494	Feed Bar Carrier Hinge Pin Set Screw...
64771	8476	“ “ “ Washer.....
64772	8498	“ “ Cover.....
64773	8476	“ “ “ Hinge Plate.....
50128e	8494	“ “ “ “ “ Screw.....
50012c	8495	“ “ “ “ “ Screw.....
64774	8476	“ “ “ Latch.....
92d	8495	“ “ “ “ “ Hinge Screw.....
64775	8476	“ “ “ “ “ Spring.....
217d	8494	“ “ “ “ “ Screw.....
64776	8476	“ “ Hinge Stud.....
1467c	8494	“ “ “ “ Cap Screw.....
1520r	8495	“ “ “ “ Nut.....
19021	8476	“ “ “ “ Washer.....
64521	8476	“ “ Lifting Link with 624c.....
125633	—	“ “ “ “ 64521 with 836f, 1021d, 51598c, 64536, 65875, 65876, 65893, 125631 and 125632.....

NO.	PLATE	NAME
1021d	8473	Feed Bar Lifting Link Cap Screw.....
64777	8476	“ “ “ “ Guide.....
171e	8473	“ “ “ “ “ Screw.....
64523	8476	“ “ “ “ “ Hinge Stud.....
624c	8494	“ “ “ “ “ “ S e t Screw.....
125629	9804	Feed Bar Shim (washer).....
64778	8499	“ Dog.....
64779	8499	“ “
64783	8481	“ “ for edge stitching.....
65938	9800	“ “ Plate with two 65940, for 65941 1367e 9800 “ “ “ Screw.....
65939	9800	“ “ “ “ “ Holder for 65941.....
65940	9800	“ “ Spur for 65938 and 65942.....
65941	9800	Feed Dog (coarse) 7 teeth (10½ teeth to the inch) complete, for straw hat work, Nos. 1367e, 65938 and 65939.....
65942	9800	Feed Dog Plate with two 65940, for 65944
65943	9800	“ “ “ “ “ Holder for 65944.....
65944	9800	Feed Dog (fine) 9 teeth (14 teeth to the inch) complete, for straw hat work, Nos. 1367e, 65942 and 65943.....
64784	8476	Feed Dog Carrier.....
50382c	8473	“ “ “ “ “ Regulating Screw.....
996c	8473	“ “ “ “ “ Screw.....
65945	9804	“ “ “ “ “ Washer.....
65952	9806	“ “ “ “ “ Packing .005 thick.....
65953	9806	“ “ “ “ “ .015 thick.....
238d	9804	“ “ “ “ “ Screw.....
50383c	8495	“ “ “ “ “ Screw.....
64787	8476	“ Eccentric with two 453c.....
453c	8494	“ “ “ “ “ Set Screw.....
64788	8490	“ Forked Connection with two each 50623e, 50624e and 64791.....
64789	8483	Feed Forked Connection Hinge Stud
64790	8483	“ “ “ “ “ “ Bushing (eccentric).....
1467c	8494	Feed Forked Connection Hinge Stud Cap Screw.....
1517e	8495	Feed Forked Connection Hinge Stud Nut
64791	8483	“ “ “ “ “ Wearing Plate
50623e	8494	“ “ “ “ “ “ Screw (long).....
50624e	8494	Feed Forked Connection Wearing Plate Screw (short).....
64533	8483	Feed Lifting Eccentric with two 453c.....

NO.	PLATE	NAME
64792	8483	Feed Lifting Eccentric Connection with 64535 and two 896E.....
65893	---	Feed Lifting Eccentric Connection 64792 with 64533.....
*64535	---	Feed Lifting Eccentric Connection Cap
896E	8494	" " " " " " Screw.....
64536	8483	Feed Lifting Eccentric Connection Stud
64537	8483	" " " " " " Bushing.....
446c	8494	Feed Lifting Eccentric Connection Stud Bushing Set Screw.....
453c	8494	Feed Lifting Eccentric Set Screw.....
64793	8482	" Regulator with 1253c, 2049 and 65801
64794	8483	" " Connecting Link.....
50625c	8495	" " " " Hinge Screw.....
1636E	8495	Feed Regulator Connecting Link Hinge Screw Nut.....
64795	8483	Feed Regulator Connecting Link Hinge Screw Washer.....
64796	8483	Feed Regulator Handle.....
2532	8483	" " " Position Pin.....
64797	8483	" " " " Plate with 125630.....
399w	8495	Feed Regulator Handle Position Plate Screw.....
125630	9806	Feed Regulator Handle Position Plate Thread Guide.....
64798	8483	Feed Regulator Handle Releasing Lever with 223b.....
64799	8483	Feed Regulator Handle Releasing Lever Hinge Pin.....
223b	9804	Feed Regulator Handle Releasing Lever Hinge Pin Set Screw.....
65913	8483	Feed Regulator Handle Spring.....
64800	8483	" " " Stud with 2532..
1253c	8494	" " " " Set Screw..
50626c	8495	" " Hinge Screw.....
1518E	8495	" " " " Nut.....
2049	8483	" " Pin.....
65801	8484	" " Shaft.....
65802	8484	" " Shaft Bushing.....
446c	8494	" " " " Set Screw
1029b	8494	" " " Cap Screw.....
65803	8484	" " Stop.....
690b	8473	" " " Screw.....

NO.	PLATE	NAME
1627D	8495	Feed Regulator Stop Screw Nut.....
65909	8484	Guide.....
64717	8484	" Holder.....
217D	8494	" Screw.....
65910	---	Guide, for edge stitching, Nos. 64717, 65909 and two 217D.....
117x7	---	Hook.....
65804	8484	" Guard.....
175E	8473	" " Screw.....
65984	9804	Loop Spreader, for straw hats.....
65986	9806	" " Driving Lever.....
125626	9804	" " " Shim.....
65987	9804	" " and Driving Lever Holder
65988	9804	" " " " " " Hinge Pin.....
*125627	---	Loop Spreader and Driving Lever Holder Hinge Pin Block.....
460c	8494	Loop Spreader and Driving Lever Holder Hinge Pin Set Screw.....
50117D	9804	Loop Spreader Driving Lever Screw.....
51875	9804	" " " " Roller and Stud.....
223b	9804	Loop Spreader Screw.....
65805	8484	Looper.....
337D	8495	" Adjusting Screw.....
64550	8484	" Carrier with 50014c and 50311c
64551	8484	" " Connecting Stud.....
64552	8484	" " " " Pin.....
50014c	8494	" " " " " Set Screw.....
65806	8482	Looper Carrier Frame with 453c, 65807 and two 456c.....
65886	---	Looper Carrier Frame complete, Nos. 193b, 208b, 337b, 874F, 64550 to 64554, 64668, 64670, 64671, 64674, 65804 to 65806, 65820, 65835, 65868 and two each 175E and 64675.....
64616	8484	Looper Carrier Frame Connecting Link..
65807	8484	" " " Cushion (rawhide)
66000	9803	" " " Spring (flat).....
65808	8485	" " " " Lifting Lever.....
2273	8485	Looper Carrier Frame Spring Lever Pin..
64720	8485	" " " " " Shaft
65809	8485	" " " " " Crank with 443c and 50150c.....

NO.	PLATE	NAME
443c	8494	Looper Carrier Frame Spring Lifting Lever Shaft Crank Set Screw (long).....
50150c	9804	Looper Carrier Frame Spring Lifting Lever Shaft Crank Set Screw (short).....
65810	8485	Looper Carrier Frame Spring Lifting Lever Shaft Crank Spring.....
175E	8173	Looper Carrier Frame Spring Lifting Lever Shaft Crank Spring Screw.....
65811	8485	Looper Carrier Frame Spring Position Plate
217D	8494	" " " " " " Screw.....
65812	8485	Looper Carrier Frame Spring Steady Pin.
64553	8485	" " Guide.....
193D	8473	" " " Screw.....
64554	8485	" " Hinge Stud.....
453c	8494	" " " " Set Screw....
125637	9804	" Eccentric.....
65814	8485	" " Body with 448c and two 129E.....
129E	8473	Looper Eccentric Body Set Screw.....
125638	9804	" " Connection with 453c, 1012c and 64558.....
1012c	8495	Looper Eccentric Connection Adjusting Screw.....
64558	8485	Looper Eccentric Connection Gib.....
125639	9804	" " " Pin.....
453c	8494	" " " " Set Screw
64560	8485	" " Pin.....
448c	8494	" " " Set Screw.....
65816	8482	" Rock Shaft.....
64562	8486	" " " Bushing (back).....
430c	8494	" " " " " Set Screw.....
64710	8486	Looper Rock Shaft Bushing (front).....
435c	8494	" " " " " Set Screw.....
64563	8486	Looper Rock Shaft Collar with 1133c....
1133c	8494	" " " " Set Screw.....
65817	8482	" " " Connecting Rod with 65818 and two 896E.....
65895	—	Looper Rock Shaft Connecting Rod 65817 with 64560, 64566, 65814, 65819, 125637 and 125639.....
*65818	—	Looper Rock Shaft Connecting Rod Cap
896E	8494	" " " " " " Screw.....

NO.	PLATE	NAME
64566	8486	Looper Rock Shaft Connecting Rod Hinge Stud.....
453c	8494	Looper Rock Shaft Connecting Rod Hinge Stud Set Screw.....
65819	8486	Looper Rock Shaft Crank (back) with 160E and 453c.....
160E	8473	Looper Rock Shaft Crank (back) Clamping Screw.....
65820	8486	Looper Rock Shaft Crank (front) with 453c.....
2049	8483	Looper Rock Shaft Crank (front) Pin
453c	8494	" " " " " Set Screw.....
874F	8473	Looper Screw.....
65990	9803	Needle Bar with 1259c.....
65991	—	Needle Bar complete, Nos. 65990 and 125628.....
64570	8486	Needle Bar Connecting Link.....
65823	8486	" " " " Slide Block
64573	8482	" " Driving Lever.....
65887	—	Needle Bar Driving Lever complete, Nos. 49174, 50258E, 64573, 64734, 65823 and two 1607E.....
50258E	8494	Needle Bar Driving Lever Adjusting Screw
1607E	8495	" " " " " " Nut.....
64574	8486	Needle Bar Driving Lever Hinge Stud with 1230F.....
65983	9804	Needle Bar Driving Lever Hinge Stud Bushing.....
1230F	8494	Needle Bar Driving Lever Hinge Stud Oil Hole Plug Screw.....
446c	8494	Needle Bar Driving Lever Hinge Stud Set Screw.....
49174	8493	Needle Bar Driving Lever Lubricating Wick.....
64734	8493	Needle Bar Driving Lever Lubricating Wick Retaining Pin.....
65824	8486	Needle Bar Eccentric with two 453c....
64576	8487	" " " Connection with 64577 and two 896E.....
*64577	—	Needle Bar Eccentric Connection Cap
896E	8494	" " " " " " Screw.....
453c	8494	Needle Bar Eccentric Set Screw.....
65992	9803	" " Guide with 460c.....
1029F	8494	" " " Adjusting Screw.....

NO.	PLATE	NAME
129D	8473	Needle Bar Guide Screw.....
*65825	—	“ “ Regulating Pitman, Nos. 64582, 64586, 64587 and 65827.....
65826	8487	Needle Bar Regulating Pitman complete, Nos. 64588, 65825 and two 5923.....
*65827	—	Needle Bar Regulating Pitman (lower)
*64582	—	“ “ “ “ (upper)
64554	8485	“ “ “ “ Hinge Stud.....
446c	8494	Needle Bar Regulating Pitman (upper) Hinge Stud Set Screw.....
65828	8487	Needle Bar Regulating Pitman Bell Crank with 448c.....
65829	—	Needle Bar Regulating Pitman Bell Crank complete, Nos. 65828, two 50627c and four each 50438D and 65830.....
50627c	8495	Needle Bar Regulating Pitman Bell Crank Ball Screw Stud.....
65830	8487	Needle Bar Regulating Pitman Bell Crank Ball Screw Stud Bearing.....
50438D	8494	Needle Bar Regulating Pitman Bell Crank Ball Screw Stud Bearing Position Screw
65831	8487	Needle Bar Regulating Pitman Bell Crank Connecting Link.....
64554	8485	Needle Bar Regulating Pitman Bell Crank Connecting Link Hinge Stud.....
448c	8494	Needle Bar Regulating Pitman Bell Crank Connecting Link Hinge Stud Set Screw
64585	8487	Needle Bar Regulating Pitman Bell Crank Hinge Pin.....
448c	8494	Needle Bar Regulating Pitman Bell Crank Hinge Pin Set Screw.....
*64586	—	Needle Bar Regulating Pitman Connect- ing Pin.....
64587	8487	Needle Bar Regulating Pitman Connect- ing Pin Rivet.....
64588	8487	Needle Bar Regulating Pitman Spring
5923	8487	“ “ “ “ “ Pin.....
64589	8482	Needle Bar Regulating Shaft.....
64590	8487	“ “ “ “ Bushing (back).....
446c	8494	Needle Bar Regulating Shaft Bushing (back) Set Screw.....
64517	8476	Needle Bar Regulating Shaft Bushing (front).....

NO.	PLATE	NAME
446c	8494	Needle Bar Regulating Shaft Bushing (front) Set Screw.....
24833	8487	Needle Bar Regulating Shaft Collar with 1019c.....
1019c	8494	Needle Bar Regulating Shaft Collar Set Screw.....
64591	8488	Needle Bar Regulating Shaft Crank (back) with three 448c.....
448c	8494	Needle Bar Regulating Shaft Crank (back) Set Screw.....
64592	8488	Needle Bar Regulating Shaft Crank (front) with two 448c.....
64593	8488	Needle Bar Regulating Shaft Crank (front) Connection with 50380c.....
212D	8494	Needle Bar Regulating Shaft Crank (front) Connection Cap Screw.....
64594	8488	Needle Bar Regulating Shaft Crank (front) Connection Hinge Stud.....
50380c	8494	Needle Bar Regulating Shaft Crank (front) Connection Hinge Stud Set Screw.....
448c	8494	Needle Bar Regulating Shaft Crank (front) Set Screw.....
65927	9804	Needle Clamp.....
125628	—	Needle Clamp complete, Nos. 208D, 50362D, 50429c, 50558c, 65927, 65929, 65930, 65933, 65934 and 65993.....
50429c	8494	Needle Clamp Adjusting Screw.....
65929	9805	“ “ Gib (.015 thick).....
65930	9805	“ “ “ (.035 thick).....
65933	9805	“ “ “ Pin.....
65934	9805	“ “ “ Plate.....
208D	8494	“ “ “ Screw.....
50558c	8495	“ “ Screw.....
1259c	8494	“ “ Set Screw.....
65835	8488	“ Guard.....
175E	8473	“ “ Screw.....
50385c	8494	“ Stop Screw.....
65993	9805	“ “ “ Bracket with 50385c and two 51875.....
50362D	9804	Needle Stop Screw Bracket Screw.....
65838	8488	Plait Guide (inside edge) Lock Stud with 13090.....
50628w	8494	Plait Guide (inside edge) Lock Stud Cap Screw.....
13090	8488	Plait Guide (inside edge) Lock Stud Posi- tion Pin.....

NO.	PLATE	NAME
1779J	8488	Plait Guide (inside edge) Lock Stud Thumb Nut.....
65946	---	Plait Guide (inside edge) Plate.....
65840	---	" " " " " Rod.....
65947	9805	" " " " Nos. 65840 and 65946.....
65841	8489	Plait Guide (lower) with 202d.....
1467D	8494	" " " Adjusting Screw.....
64604	---	Plait Guide (stationary) Nos. 64605 and 64606.....
64605	8489	Plait Guide (stationary) Bracket with 465c
64606	8489	" " " Rod, for fine braid
65842	8489	" " " " " medium braid.....
65843	8489	Plait Guide (stationary) Rod, for coarse braid.....
465c	8494	Plait Guide (stationary) Rod Set Screw for 64605.....
202D	8494	Plait Guide (stationary) Rod Set Screw for 65841.....
64607	8489	Plait Guide (upper).....
32262	8489	" " " Friction Washer.....
89w	8495	" " " Hinge Screw.....
65844	8489	" " " Holder with 54705..
64609	8489	" " " Lock Stud.....
32240	8489	" " " " " Spring
50117w	8494	" " " " " " Screw.....
208w	8494	Plait Guide (upper) Screw.....
54705	8489	" " " Steady Pin.....
65845	---	Plait Guide complete, Nos. 89w, 208w, 1779J, 32240, 32262, 50117w, 50628w, 64607, 64609, 65838, 65841, 65844 and 65947.....
65846	8489	Plait Guide Block.....
219D	8494	" " " Screw.....
19054	8489	" " Friction Washer.....
64614	8473	" " Regulating Pinion.....
50386F	8473	" " " Screw.....
50387F	8473	" " Screw.....
65847	8482	Presser Bar with 64664.....
64618	8488	" " Adjusting Pin.....
446c	8494	" " " " Set Screw.....
65848	8488	" " Lifter (side of arm).....
64622	8488	" " " " " Hinge Pin.....

NO.	PLATE	NAME
64623	8488	Presser Bar Lifter (side of arm) Shaft
64624	8488	" " " " " " " " Crank with 735c.....
2269	8488	Presser Bar Lifter (side of arm) Shaft Crank Pin.....
735c	8494	Presser Bar Lifter (side of arm) Shaft Crank Set Screw.....
64625	8488	Presser Bar Lifter (side of arm) Spring
208D	8494	" " " " " " " " Screw.....
64626	8488	Presser Bar Lifter (side of arm) Stop Bracket.....
159D	8473	Presser Bar Lifter (side of arm) Stop Bracket Screw.....
64627	8490	Presser Bar Lifting Shaft.....
64628	8486	" " " " Bushing.....
453c	8494	" " " " " " S e t Screw.....
*65849	8491	Presser Bar Lifting Shaft Crank (back) with 446c and 448c.....
898c	8494	Presser Bar Lifting Shaft Crank (back) Adjusting Screw.....
*65850	8491	Presser Bar Lifting Shaft Crank (back) Connection with 446c.....
64631	8491	Presser Bar Lifting Shaft Crank (back) Extension with 453c.....
453c	8494	Presser Bar Lifting Shaft Crank (back) Extension Set Screw.....
446c	8494	Presser Bar Lifting Shaft Crank (back) Set Screw (long).....
448c	8494	Presser Bar Lifting Shaft Crank (back) Set Screw (short).....
65851	8491	Presser Bar Lifting Shaft Crank (front) with 1390e.....
1390E	8495	Presser Bar Lifting Shaft Crank (front) Set Screw.....
65907	8491	Presser Bar Tipper.....
50649c	8494	" " " Adjusting Screw.....
50629c	8495	" " " Screw Stud.....
1712c	8495	" " " " " Thumb Nut.....
65908	8491	Presser Bar Tipper Spring.....
65954	---	" Foot Guide for 65962.....
65955	---	" " " " 65963.....
65956	---	" " " " 65964.....
65957	---	" " " " 65965.....
64641	---	" " " " 65862.....

NO.	PLATE	NAME
64642	---	Presser Foot Guide for 65863.....
64643	---	" " " " 65864 and 65865..
64644	---	" " " " Adjusting Lever with 19045 and 19046.....
5480	8491	Presser Foot Guide Adjusting Lever Friction Washer.....
19045	8491	Presser Foot Guide Adjusting Lever Handle.....
19046	8491	Presser Foot Guide Adjusting Lever Pin.
50388c	8473	" " " " " Screw
65958	---	" " Plate for 65962.....
65959	---	" " " " 65963.....
65960	---	" " " " 65964.....
65961	---	" " " " 65965.....
65973	---	" " " " 65978.....
65974	---	" " " " 65979.....
65975	---	" " " " 65980.....
65976	---	" " " " 65981.....
64722	---	" " " " 65866.....
1472r	8495	" " " " Screw.....
65856	---	" " Shank for 65962 to 65965...
65911	---	" " " " 65866.....
65977	---	" " " " 65978 to 65981...
65962	9801	Presser Foot complete, for chip fine milan, Nos. 5480, 50388c, 64644, 65856, 65954, 65958 and two 1472r.....
65963	9801	Presser Foot complete, for medium milan, Nos. 5480, 50388c, 64644, 65856, 65955, 65959 and two 1472r.....
65964	9801	Presser Foot complete, for fine canton, Nos. 5480, 50388c, 64644, 65856, 65956, 65960 and two 1472r.....
65965	9801	Presser Foot complete, for canton, Nos. 5480, 50388c, 64644, 65856, 65957, 65961 and two 1472r.....
65978	9802	Presser Foot complete, for whole straw and mackinaw, Nos. 5480, 50388c, 64641, 64644, 65973, 65977 and two 1472r....
65979	9802	Presser Foot complete, for rough and ready, Nos. 5480, 50388c, 64642, 64644, 65974, 65977 and two 1472r.....
65980	9802	Presser Foot complete, for coarse braid, Nos. 5480, 50388c, 64643, 64644, 65975, 65977 and two 1472r.....
65981	9802	Presser Foot complete, for double cord edge, Nos. 5480, 50388c, 64643, 64644, 65976, 65977 and two 1472r.....

NO.	PLATE	NAME
65866	8481	Presser Foot complete for 64783, Nos. 64722, 65911 and two 1472r.....
64664	8489	Presser Foot Position Pin.....
914f	8473	" " Screw.....
574w	8473	Pressure Regulating Thumb Screw.....
1539w	8495	" " " " Lock Nut.....
32191	8491	Tension Disc.....
1712c	8495	" Regulating Thumb Nut.....
32192	8491	" Regulator with 32193.....
32193	8491	" " Bushing.....
32194	8491	" " Friction Spring.....
32195	8491	" " Plate.....
393b	8495	" " " " Screw.....
65867	8491	" Releasing Disc.....
54515	8491	" " Pin.....
50630c	8491	" Screw Stud.....
51808	8491	" " " Roller.....
133b	8494	" " " Set Screw.....
64754	8491	" Spring.....
22430	8491	" Thread Eyelet.....
65868	8492	Thread Carrier.....
64668	8492	" " Clamping Plate.....
64669	8492	" " " " Position Pin.....
208b	8494	Thread Carrier Clamping Plate Screw...
64670	8492	" " Holder with 202b and 64669.....
202b	8494	Thread Carrier Holder Clamping Screw..
64671	8492	Thread Carrier Pitman complete, Nos. 1550r, 1682r, 52869, 52870 and 64673..
64672	8492	Thread Carrier Pitman Ball Stud (lower)
460c	8494	" " " " " " "
		Set Screw.....
52863	8492	Thread Carrier Pitman Ball Stud (upper)
50311c	8494	" " " " " " "
		Set Screw.....
*52864	---	Thread Carrier Pitman Cap (lower).....
208e	8494	" " " " " " Screw
*52865	---	" " " " " (upper).....
208e	8494	" " " " " " Screw
*52866	---	" " " " End Bearing (lower).....
*52867	---	Thread Carrier Pitman End Bearing (upper).....
64673	---	Thread Carrier Pitman Head (lower) Nos. 52864, 52866, 64672 and two 208e....

NO.	PLATE	NAME
53226	---	Thread Carrier Pitman Head (upper) Nos. 52865, 52867 and two 208E.....
52869	---	Thread Carrier Pitman Head (upper) 53226 with 52863.....
52870	8492	Thread Carrier Pitman Rod.....
1682J	8492	" " " " Nut (lower).
1550J	8492	" " " " " (upper)
64674	8492	" " Rock Shaft with 460c....
64675	8492	" " " " Centre.....
456c	8494	" " " " " S e t Screw.....
64677	8492	Thread Nipper Body.....
64678	8492	" " " Collar.....
156F	8473	" " " Screw.....
65923	9805	" " Cam with two 453c.....
453c	8494	" " " Set Screw.....
64676	8492	" " Eyelet.....
65869	8490	" " Regulator and Tension Releaser.....
230w	8494	Thread Nipper Regulator and Tension Releaser Screw.....
65968	9806	Thread Nipper Releaser with 65970.....
65969	9805	" " " Crank with 161c
161c	9805	" " " " Clamping Screw.....
1989	9805	Thread Nipper Releaser Roller.....
12329	9805	" " " Spring.....
65970	9806	" " " Stud.....
65971	9806	" " " Stop Lever.....
168c	9806	" " " " " Screw
51008A	9806	" " Screw.....
65924	9806	" " " Bushing.....
124088	9806	" " " Spring....
65925	9806	" " Stud.....
65972	---	" " " 65925 with 1989, 51140F, 51141F and 65926.....
51140F	9806	Thread Nipper Stud Position Screw.....
65926	9806	" " " Roller.....
51141F	9806	" " " " Screw.....
65982	---	Thread Nipper complete, Nos. 51008A, 65923, 65924, 65972 and 124088.....
65870	8492	Thread Take-up (back).....
65871	8492	" " " Holder with 624c
65872	8492	" " " " Adjusting Plate with 51869.....
51869	---	Thread Take-up (back) Holder Adjusting Plate Roller and Stud.....

NO.	PLATE	NAME
898c	8494	Thread Take-up (back) Holder Adjusting Plate Screw.....
19044	8492	Thread Take-up (back) Holder Adjusting Plate Screw Washer.....
624c	8494	Thread Take-up (back) Set Screw.....
65994	9806	" " " Staple.....
1319w	8195	" " " " S c r e w
64698	8493	" " " " " " Washer.....
65873	8493	Thread Take-up (front).....
125631	9806	" " " " Arm with 185D..
65875	8493	" " " " Connecting Link.....
836F	8495	Thread Take-up (front) Arm Connecting Link Hinge Screw.....
65876	8493	Thread Take-up (front) Arm Hinge Stud (long).....
457c	8494	Thread Take-up (front) Arm Hinge Stud (long) Set Screw.....
125632	9806	Thread Take-up (front) Arm Hinge Stud (short).....
51598c	9806	Thread Take-up (front) Arm Hinge Stud (short) Nut.....
185D	8494	Thread Take-up (front) Clamping Screw.
64699	8493	" Tube.....
460c	8494	" " Set Screw.....
65877	8499	Throat Plate for 64778 and 64779.....
65879	8481	" " " 64783.....
65951	9800	" " " 65941 and 65944.....
65995	9803	" " " Holder with 460c and 125627
65996	---	Throat Plate Holder 65995 with 665D, 64703 to 64705, 65951 and two 211D...
125634	---	Throat Plate Holder 65996 with 65987 and 65988.....
64703	8490	Throat Plate Holder Cover.....
64728	8490	" " " " for edge stitch- ing.....
64704	8493	Throat Plate Holder Cover Hinge Pin...
64705	8493	" " " " Spring.....
665D	8494	" " " " " Screw
180D	8473	" " " Screw.....
211D	8494	" " Screw.....

LIST OF PARTS COMPLETE
FOR
MACHINE No. 117-4

FOR MILLINERY WORK, CONCEALED STITCH. ONE NEEDLE, ONE HOOK-EYE NEEDLE, POSITIVE SET FOR REGULATION OF LENGTH OF STITCH. LENGTH OF STITCH $\frac{3}{8}$ TO $\frac{3}{8}$ INCH. THE MACHINE IS FITTED WITH A THREAD NIPPER RELEASER AND LOOP SPREADER, ALSO A HINGED COVER TO THROW BACK, FOR CONVENIENCE OF REACHING THE LOWER PARTS OF THE MACHINE.

NO.	PLATE	NAME
*64765	----	Arm, upper and lower (solid) with 64772, two each 50012c, 64773 and four 50128E
64751	8475	Arm End Cover (back).....
	219d 8494	" " " " Screw.....
64766	8475	" " " " (front).....
	330b 8495	" " " " Screw.....
56003	8484	" Oil Tube with 52045.....
52045	9804	" " " Packing (felt).....
65914	8475	" Rotary Shaft.....
64505	8476	" " " Bushing (front).....
	453c 8494	" " " " " " S e t Screw.....
65915	8476	Arm Rotary Shaft Bushing (intermediate) Eccentric.....
	1299c 9804	Arm Rotary Shaft Bushing (intermediate) Eccentric Set Screw.....
32152	8476	Arm Rotary Shaft Collar with two 889c.....
	889c 8494	" " " " " Set Screw.....
64507	8475	" " " Flanged Bushing (back) with 64508.....
64508	8482	Arm Rotary Shaft Flanged Bushing (back) Oil Pad (braided cotton).....
	159f 8473	Arm Rotary Shaft Flanged Bushing (back) Screw.....
64509	8475	Arm Side Cover.....
	219d 8494	" " " " " Screw.....
64510	8475	Balance Wheel, 3 in. pulley, with two 448c.....
	448c 8494	" " " " " Set Screw.....
64768	8475	Face Plate.....
	219d 8494	" " " " " Screw.....
64769	8475	Feed Bar.....
64770	8482	" " Carrier with 453c.....

NO.	PLATE	NAME
64516	8482	Feed Bar Carrier Hinge Pin.....
64517	8476	" " " " " Bushing.....
	446c 8494	" " " " " " " Set Screw.....
	453c 8494	Feed Bar Carrier Hinge Pin Set Screw....
64771	8476	" " " Washer.....
64772	8498	" " Cover.....
64773	8476	" " " Hinge Plate.....
50128E	8494	" " " " " Screw.....
50012c	8495	" " " " " Screw.....
64774	8476	" " " Latch.....
	92d 8495	" " " " " Hinge Screw.....
64775	8476	" " " " " Spring.....
	217d 8494	" " " " " " " Screw.....
64776	8476	" " Hinge Stud.....
	1467c 8494	" " " " " Cap Screw.....
	1520r 8495	" " " " " Nut.....
19021	8476	" " " " " Washer.....
64521	8476	" " Lifting Link with 624c.....
125633	----	" " " " " 64521 with 836f, 1021d, 51598c, 64536, 65875, 65876, 65893, 125631 and 125632.....
	1021d 8473	Feed Bar Lifting Link Cap Screw.....
64777	8476	" " " " " Guide.....
	171e 8473	" " " " " " " Screw.....
64523	8476	" " " " " Hinge Stud.....
	624c 8494	" " " " " " " S e t Screw.....
125629	9804	Feed Bar Shim Washer.....
65936	8499	Feed Dog (coarse) 7 teeth (10½ teeth to the inch) for felt hat work.....
65937	8499	Feed Dog (fine) 10 teeth (14 teeth to the inch) for felt hat work.....
65938	9800	Feed Dog Plate with two 65940, for 65941.....
	1367f 9800	" " " " " Screw.....
65939	9800	" " " " " Holder for 65941.....
65940	9800	" " Spur for 65938 and 65942.....
65941	9800	Feed Dog (coarse) 7 teeth (10½ teeth to the inch) complete, for straw hat work, Nos. 1367e, 65938 and 65939.....
65942	9800	Feed Dog Plate with two 65940, for 65944.....
65943	9800	" " " " " Holder for 65944.....
65944	9800	Feed Dog (fine) 9 teeth (14 teeth to the inch) complete, for straw hat work, Nos. 1367e, 65942 and 65943.....
64784	8476	Feed Dog Carrier.....
50382c	8473	" " " " " Regulating Screw.....

NO.	PLATE	NAME
996c	8473	Feed Dog Carrier Screw.....
65945	9804	" " " Washer.....
65952	9806	" " Packing .005 thick.....
65953	9806	" " " .015 thick.....
238d	9804	" " " Screw.....
50383c	8495	" " Screw.....
64787	8476	" Eccentric with two 453c.....
453c	8494	" " Set Screw.....
64788	8490	Feed Forked Connection with two each 50623E, 50624E and 64791.....
64789	8483	Feed Forked Connection Hinge Stud.....
64790	8483	" " " " " Bush- ing (eccentric).....
1467c	8494	Feed Forked Connection Hinge Stud Cap Screw.....
1517E	8495	Feed Forked Connection Hinge Stud Nut
64791	8483	" " " Wearing Plate
50623E	8494	" " " " " "
50624E	8494	Feed Forked Connection Wearing Plate Screw (short).....
64533	8483	Feed Lifting Eccentric with two 453c....
64792	8483	" " " Connection with 64535 and two 896E.....
65893	---	Feed Lifting Eccentric Connection 64792 with 64533.....
*64535	---	Feed Lifting Eccentric Connection Cap
896E	8494	" " " " " "
64536	8483	Feed Lifting Eccentric Connection Stud
64537	8483	" " " " " "
446c	8494	Feed Lifting Eccentric Connection Stud Bushing Set Screw.....
453c	8494	Feed Lifting Eccentric Set Screw.....
64793	8482	" Regulator with 1253c, 2049 and 65801.....
64794	8483	Feed Regulator Connecting Link.....
50625c	8495	" " " " " Hinge Screw.....
1636E	8495	Feed Regulator Connecting Link Hinge Screw Nut.....
64795	8483	Feed Regulator Connecting Link Hinge Screw Washer.....
64796	8483	Feed Regulator Handle.....
2532	8483	" " " Position Pin.....

NO.	PLATE	NAME
64797	8483	Feed Regulator Handle Position Plate with 125630.....
399w	8495	Feed Regulator Handle Position Plate Screw.....
125630	9806	Feed Regulator Handle Position Plate Thread Guide.....
64798	8483	Feed Regulator Handle Releasing Lever with 223b.....
64799	8483	Feed Regulator Handle Releasing Lever Hinge Pin.....
223d	9804	Feed Regulator Handle Releasing Lever Hinge Pin Set Screw.....
65913	8483	Feed Regulator Handle Spring.....
64800	8483	" " " Stud with 2532..
1253c	8494	" " " " Set Screw.
50626c	8495	" " Hinge Screw.....
1518E	8495	" " " Nut.....
2049	8483	" " Pin.....
65801	8484	" " Shaft.....
65802	8484	" " " Bushing.....
446c	8494	" " " " Set Screw.
1029d	8494	" " " Cap Screw.....
65803	8484	" " Stop.....
690d	8473	" " " Screw.....
1627d	8495	" " " " Nut.....
65909	8484	Guide.....
64717	8484	" Holder.....
217d	8494	" Screw.....
65910	---	Guide, for edge stitching, Nos. 64717, 65909 and two 217d.....
117x7	---	Hook.....
65804	8484	" Guard.....
175E	8473	" " Screw.....
65984	9804	Loop Spreader, for straw hats.....
65985	9804	" " " millinery work.....
65986	9806	" " Driving Lever.....
125626	9804	" " " Shim.....
65987	9804	" " and Driving Lever Holder
65988	9804	" " " " " "
*125627	---	Hinge Pin.....
460c	8494	Loop Spreader and Driving Lever Holder Hinge Pin Block.....
50117d	9804	Loop Spreader and Driving Lever Holder Hinge Pin Set Screw.....
51875	9804	Loop Spreader Driving Lever Screw.....
		" " " " Roller and Stud.....

NO.	PLATE	NAME
65887	—	Needle Bar Driving Lever complete, Nos. 49174, 50258E, 64573, 64734, 65823 and two 1607E.....
50258E	8494	Needle Bar Driving Lever Adjusting Screw
1607E	8495	“ “ “ “ “ “ Nut.....
64574	8486	Needle Bar Driving Lever Hinge Stud with 1230F.....
65983	9804	Needle Bar Driving Lever Hinge Stud Bushing.....
1230F	8494	Needle Bar Driving Lever Hinge Stud Oil Hole Plug Screw.....
446C	8494	Needle Bar Driving Lever Hinge Stud Set Screw.....
49174	8493	Needle Bar Driving Lever Lubricating Wick.....
64734	8493	Needle Bar Driving Lever Lubricating Wick Retaining Pin.....
65824	8486	Needle Bar Eccentric with two 453C.....
64576	8487	“ “ “ Connection with 64577 and two 896E.....
*64577	—	Needle Bar Eccentric Connection Cap
896E	8494	“ “ “ “ “ “ Screw.....
453C	8494	Needle Bar Eccentric Set Screw.....
65992	9803	“ “ Guide with 460C.....
1029F	8494	“ “ “ Adjusting Screw.....
129D	8473	“ “ “ Screw.....
*65825	—	“ “ Regulating Pitman, Nos. 64582, 64586, 64587 and 65827.....
65826	8487	Needle Bar Regulating Pitman complete, Nos. 64588, 65825 and two 5923.....
*65827	—	Needle Bar Regulating Pitman (lower)...
*64582	—	“ “ “ “ (upper)
64551	8485	“ “ “ “ “ “ Hinge Stud.....
446C	8494	Needle Bar Regulating Pitman (upper) Hinge Stud Set Screw.....
65828	8487	Needle Bar Regulating Pitman Bell Crank with 448C.....
65829	—	Needle Bar Regulating Pitman Bell Crank complete, Nos. 65828, two 50627C and four each 50438D and 65830.....
50627C	8495	Needle Bar Regulating Pitman Bell Crank Ball Screw Stud.....
65830	8487	Needle Bar Regulating Pitman Bell Crank Ball Screw Stud Bearing.....

NO.	PLATE	NAME
50438D	8494	Needle Bar Regulating Pitman Bell Crank Ball Screw Stud Bearing Position Screw
65831	8487	Needle Bar Regulating Pitman Bell Crank Connecting Link.....
64554	8485	Needle Bar Regulating Pitman Bell Crank Connecting Link Hinge Stud.....
448C	8494	Needle Bar Regulating Pitman Bell Crank Connecting Link Hinge Stud Set Screw
64585	8487	Needle Bar Regulating Pitman Bell Crank Hinge Pin.....
448C	8494	Needle Bar Regulating Pitman Bell Crank Hinge Pin Set Screw.....
*64586	—	Needle Bar Regulator Pitman Connecting Pin.....
64587	8487	Needle Bar Regulating Pitman Connecting Pin Rivet.....
64588	8487	Needle Bar Regulating Pitman Spring....
5923	8487	“ “ “ “ “ Pin
64589	8482	“ “ “ Shaft.....
64590	8487	“ “ “ “ Bushing (back).....
446C	8494	Needle Bar Regulating Shaft Bushing (back) Set Screw.....
64517	8476	Needle Bar Regulating Shaft Bushing (front).....
446C	8494	Needle Bar Regulating Shaft Bushing (front) Set Screw.....
24833	8487	Needle Bar Regulating Shaft Collar with 1019C.....
1019C	8494	Needle Bar Regulating Shaft Collar Set Screw.....
64591	8488	Needle Bar Regulating Shaft Crank (back) with three 448C.....
448C	8494	Needle Bar Regulating Shaft Crank (back) Set Screw.....
64592	8488	Needle Bar Regulating Shaft Crank (front) with two 448C.....
64593	8488	Needle Bar Regulating Shaft Crank (front) Connection with 50380C.....
212D	8494	Needle Bar Regulating Shaft Crank (front) Connection Cap Screw.....
64594	8488	Needle Bar Regulating Shaft Crank (front) Connection Hinge Stud.....
50380C	8494	Needle Bar Regulating Shaft Crank (front) Connection Hinge Stud Set Screw....
448C	8494	Needle Bar Regulating Shaft Crank (front) Set Screw.....

NO.	PLATE	NAME
65927	9804	Needle Clamp.....
125628	—	Needle Clamp complete, Nos. 208d, 50362d, 50429c, 50558c, 65927, 65929, 65930, 65933, 65934 and 65993.....
50429c	8494	Needle Clamp Adjusting Screw.....
65929	9805	" " Gib (.015 in. thick).....
65930	9805	" " " (.035 in. thick).....
65933	9805	" " " Pin.....
65934	9805	" " Plate.....
208d	8494	" " " Screw.....
50558c	8495	" " Screw.....
1259c	8494	" " Set Screw.....
65835	8488	" Guard.....
175e	8473	" " Screw.....
50385c	8494	" Stop Screw.....
65993	9805	" " " Bracket with 50385c and two 51875.....
50362d	9804	Needle Stop Screw Bracket Screw.....
65838	8488	Plait Guide (inside edge) Lock Stud with 13090.....
50628w	8494	Plait Guide (inside edge) Lock Stud Cap Screw.....
13090	8488	Plait Guide (inside edge) Lock Stud Position Pin.....
1779j	8488	Plait Guide (inside edge) Lock Stud Thumb Nut.....
65946	—	Plait Guide (inside edge) Plate.....
65840	—	" " " " Rod.....
65947	9805	" " " " Nos. 65840 and 65946.....
65841	8489	Plait Guide (lower) with 202d.....
1467d	8494	" " " Adjusting Screw.....
64604	—	" " (stationary), Nos. 64605 and 64606.....
64605	8489	Plait Guide (stationary) Bracket with 465c.....
64606	8489	Plait Guide (stationary) Rod, for fine braid
65842	8489	" " " " " medium braid.....
65843	8489	Plait Guide (stationary) Rod for coarse braid.....
465c	8494	Plait Guide (stationary) Rod Set Screw for 64605.....
202d	8494	Plait Guide (stationary) Rod Set Screw for 65841.....
64607	8489	Plait Guide (upper).....
32262	8489	" " " Friction Washer.....

NO.	PLATE	NAME
89w	8495	Plait Guide (upper) Hinge Screw.....
65844	8489	" " " Holder with 54705....
64609	8489	" " " Lock Stud.....
32240	8489	" " " " " Spring
50117w	8494	" " " " " "
		Screw.....
208w	8494	Plait Guide (upper) Screw.....
54705	8489	" " " Steady Pin.....
65845	—	Plait Guide complete, Nos. 89w, 208w, 1779j, 32240, 32262, 50117w, 50628w, 64607, 64609, 65838, 65841, 65844 and 65947.....
65846	8489	Plait Guide Block.....
219d	8494	" " " Screw.....
19054	8489	" " Friction Washer.....
64614	8473	" " Regulating Pinion.....
50386f	8473	" " " " Screw....
50387f	8473	" " Screw.....
65817	8482	Presser Bar with 64664.....
64618	8488	" " Adjusting Pin.....
446c	8494	" " " " Set Screw....
65848	8488	" " Lifter (side of arm).....
64622	8488	" " " " " " Hinge Pin.....
64623	8488	Presser Bar Lifter (side of arm) Shaft
64624	8488	" " " " " " "
		Crank with 735c.....
2269	8488	Presser Bar Lifter (side of arm) Shaft
		Crank Pin.....
735c	8494	Presser Bar Lifter (side of arm) Shaft
		Crank Set Screw.....
64625	8488	Presser Bar Lifter (side of arm) Spring
208d	8494	" " " " " " "
		Screw.....
64626	8488	Presser Bar Lifter (side of arm) Stop Bracket.....
159d	8473	Presser Bar Lifter (side of arm) Stop Bracket Screw.....
64627	8490	Presser Bar Lifting Shaft.....
64628	8486	" " " " Bushing.....
453c	8494	" " " " " " S e t Screw.....
*65849	8491	Presser Bar Lifting Shaft Crank (back) with 446c and 448c.....
898c	8494	Presser Bar Lifting Shaft Crank (back) Adjusting Screw.....

NO.	PLATE	NAME
*65850	8491	Presser Bar Lifting Shaft Crank (back) Connection with 446c.....
64631	8491	Presser Bar Lifting Shaft Crank (back) Extension with 453c.....
453c	8491	Presser Bar Lifting Shaft Crank (back) Extension Set Screw.....
446c	8494	Presser Bar Lifting Shaft Crank (back) Set Screw (long).....
448c	8494	Presser Bar Lifting Shaft Crank (back) Set Screw (short).....
65851	8491	Presser Bar Lifting Shaft Crank (front) with 1390E.....
1390E	8495	Presser Bar Lifting Shaft Crank (front) Set Screw.....
65907	8491	Presser Bar Tipper.....
50649c	8494	" " " Adjusting Screw.....
50629c	8495	" " " Screw Stud.....
1712c	8495	" " " " " Thumb Nut.....
65908	8491	Presser Bar Tipper Spring.....
65954	----	" Foot Guide for 65962.....
65955	----	" " " " 65963.....
65956	----	" " " " 65964.....
65957	----	" " " " 65965.....
64644	----	" " " Adjusting Lever with 19045 and 19046.....
5180	8491	Presser Foot Guide Adjusting Lever Fric- tion Washer.....
19045	8491	Presser Foot Guide Adjusting Lever Handle.....
19046	8491	Presser Foot Guide Adjusting Lever Pin..
50388c	8473	" " " " " Screw
65958	----	" " Plate for 65962.....
65959	----	" " " " 65963.....
65960	----	" " " " 65964.....
65961	----	" " " " 65965.....
1472r	8495	" " " Screw.....
65856	----	" " Shank for 65962 to 65965...
65967	9805	" " for felt hat work.....
65962	9801	Presser Foot complete, for chip fine milan, Nos. 5180, 50388c, 64644, 65856, 65954, 65958 and two 1472r.....
65963	9801	Presser Foot complete, for medium milan, Nos. 5480, 50388c, 64644, 65856, 65955, 65959 and two 1472r.....

NO.	PLATE	NAME
65964	9801	Presser Foot complete, for fine canton, Nos. 5480, 50388c, 64644, 65856, 65956, 65960 and two 1472r.....
65965	9801	Presser Foot complete, for canton, Nos. 5480, 50388c, 64644, 65856, 65957, 65961 and two 1472r.....
64664	8489	Presser Foot Position Pin.....
914f	8473	" " Screw.....
574w	8473	Pressure Regulating Thumb Screw.....
1539w	8495	" " " " Lock Nut.....
32191	8491	Tension Disc.....
1712c	8495	" Regulating Thumb Nut.....
32192	8491	" Regulator with 32193.....
32193	8491	" " Bushing.....
32194	8491	" " Friction Spring.....
32195	8491	" " Plate.....
393d	8495	" " " Screw.....
65867	8491	" Releasing Disc.....
54515	8491	" " Pin.....
50630c	8491	" Screw Stud.....
51808	8491	" " " Roller.....
133d	8494	" " " Set Screw.....
64754	8491	" Spring.....
22430	8491	" Thread Eyelet.....
65868	8492	Thread Carrier.....
64668	8492	" " Clamping Plate.....
64669	8492	" " " " Position Pin.....
208d	8494	Thread Carrier Clamping Plate Screw...
64670	8492	" " Holder with 202d and 64669.....
202d	8494	Thread Carrier Holder Clamping Screw..
64671	8492	Thread Carrier Pitman complete, Nos. 1550j, 1682j, 52869, 52870 and 64673..
64672	8492	Thread Carrier Pitman Ball Stud (lower)
460c	8494	" " " " " " " Set Screw.....
52863	8492	Thread Carrier Pitman Ball Stud (upper)
50311c	8491	" " " " " " " Set Screw.....
*52864	----	Thread Carrier Pitman Cap (lower).....
208e	8494	" " " " " Screw
*52865	----	" " " " (upper).....
208e	8494	" " " " " Screw
*52866	----	" " " " End Bearing (lower).....

NO.	PLATE	NAME
*52867	---	Thread Carrier Pitman End Bearing (upper).....
64673	---	Thread Carrier Pitman Head (lower), Nos. 52864, 52866, 64672 and two 208E....
53226	---	Thread Carrier Pitman Head (upper), Nos. 52865, 52867 and two 208E....
52869	---	Thread Carrier Pitman Head (upper) 53226 with 52863.....
52870	8492	Thread Carrier Pitman Rod.....
1682d	8492	" " " " Nut (lower).
1550j	8492	" " " " " (upper)
64674	8492	" " " " Rock Shaft with 460c....
64675	8492	" " " " Centre.....
456c	8494	" " " " " Set Screw.....
64677	8492	Thread Nipper Body.....
64678	8492	" " " Collar.....
156F	8473	" " " Screw.....
65923	9805	" " Cam with two 453c.....
453c	8494	" " " Set Screw.....
64676	8492	" " Eyelet.....
65869	8490	" " Regulator and Tension Releaser.....
230w	8494	Thread Nipper Regulator and Tension Releaser Screw.....
65968	9806	Thread Nipper Releaser with 65970.....
65969	9805	" " " Crank with 161c
161c	9805	" " " " Clamping Screw.....
1989	9805	Thread Nipper Releaser Roller.....
12329	9805	" " " Spring.....
65970	9806	" " " Stud.....
65971	9806	" " " Stop Lever.....
168c	9806	" " " " " Screw
51008A	9806	" " " Screw.....
65924	9806	" " " Bushing.....
124088	9806	" " " Spring....
65925	9806	" " Stud.....
65972	---	" " " 65925 with 1989, 51140F, 51141F, and 65926.....
51140F	9806	Thread Nipper Stud Position Screw.....
65926	9806	" " " Roller.....
51141F	9806	" " " " Screw.....
65982	---	Thread Nipper complete, Nos. 51008A, 65923, 65924, 65972 and 124088.....
65870	8492	Thread Take-up (back).....
65871	8492	" " " Holder with 624c

NO.	PLATE	NAME
65872	8492	Thread Take-up (back) Holder Adjusting Plate with 51869.....
51869	---	Thread Take-up (back) Holder Adjusting Plate Roller and Stud.....
898c	8494	Thread Take-up (back) Holder Adjusting Plate Screw.....
19044	8492	Thread Take-up (back) Holder Adjusting Plate Screw Washer.....
624c	8494	Thread Take-up (back) Set Screw.....
65994	9806	" " " Staple.....
1319w	8495	" " " " " S c r e w
64698	8493	" " " " " " Washer.....
65873	8493	Thread Take-up (front).....
125631	9806	" " " " Arm with 185D..
65875	8493	" " " " " Connecting Link.....
836F	8495	Thread Take-up (front) Arm Connecting Link Hinge Screw.....
65876	8493	Thread Take-up (front) Arm Hinge Stud (long).....
457c	8494	Thread Take-up (front) Arm Hinge Stud (long) Set Screw.....
125632	9806	Thread Take-up (front) Arm Hinge Stud (short).....
51598c	9806	Thread Take-up (front) Arm Hinge Stud (short) Set Screw.....
185D	8494	Thread Take-up (front) Clamping Screw.
64699	8493	" Tube.....
460c	8494	" " Set Screw.....
65950	8499	Throat Plate for 65936 and 65937.....
65951	9800	" " " 65941 and 65944.....
65995	9803	" " Holder with 460c and 125627
65996	---	" " " 65995 with 665D, 64703 to 64705, 65951 and two 211D...
65999	---	Throat Plate Holder 65995 with 665D, 64703 to 64705, 65950 and two 211D...
125634	---	Throat Plate Holder 65996 with 65987 and 65988.....
125635	---	Throat Plate Holder 65999 with 65987 and 65988.....
64703	8490	Throat Plate Holder Cover.....
64704	8493	" " " " " Hinge Pin...
64705	8493	" " " " " Spring.....
665D	8494	" " " " " " Screw.
180D	8473	" " " " " Screw.....
211D	8494	" " " " " Screw.....

IRON BASE

NO.	PLATE	NAME
64706	S498	Machine Base with three wood screws 1¼ in. No. 14 and four each 935b, 42088 and 66707.....
64707	S496	Machine Base Oil Cup with 64708.....
64708	S496	“ “ “ “ Handle.....
42088	S474	“ Cushion (felt).....
935E	S494	“ “ Screw.....
66707	S489	“ “ “ Washer.....
50314w	S474	“ Thumb Screw.....

ACCESSORIES

NO.	PLATE	NAME
120346	S496	Oiler (copper plated) with 120347.....
120347	S496	“ Spout, 9 in. long.....
11831	S496	Screw Driver.....
120341	S496	Tweezers (curved).....
8908	S496	Wrench for 1520.....
22003	S496	“ “ 1550 and 1682.....
23535	S496	“ “ 1547, 50388 and 50558.....
58844	S496	“ “ 1517, 1518, 1636 and 64790..

FOOT LIFTER PARTS

NO.	PLATE	NAME
13351	---	Chain, 46 in. to 55 in., with 56864 and 56865.....
NOTE: When ordering No. 13351 give length required.		
4879	S496	Chain Connecting Link.....
56864	S496	“ Hook (large).....
56865	S493	“ “ (small).....
64631	S491	Presser Bar Lifting Shaft Crank (back) Extension with 453c.....
453c	S494	Presser Bar Lifting Shaft Crank (back) Extension Set Screw.....
17876	S498	Treadle with 443c.....
17881	S496	“ Shaft.....
443c	S494	“ “ Set Screw.....
17882	S493	“ Spring.....
17883	S498	“ Stand.....
17884	S498	Treadle complete, Nos. 17876, 17881 to 17883 and two wood screws 1 in. No. 10
64709	---	Foot Lifter complete, Nos. 13351, 17884 and 64631.....

FOOT LIFTER CHAIN GUIDE

NO.	PLATE	NAME
65883	S496	Foot Lifter Chain Guide Bracket.....
2461	S493	“ “ “ “ Pulley.....
65884	S493	“ “ “ “ “ Pin.....
65885	---	Foot Lifter Chain Guide complete, Nos. 2461, 65883, 65884 and four wood screws 1 in. No. 10 R. H. B.....

TABLE SUPPORT PARTS

NO.	PLATE	NAME
41044	S498	Base with three wood screws 1¼ in. No. 14
41045	S498	Top with two wood screws 1¼ in. No. 14
41046	S498	Tube.....
1726e	S474	“ Lock Nut.....
41047	---	Table Support Tube complete, Nos. 1726e and 41044 to 41046.....

THREAD NIPPER TIMING GAUGE

NO.	PLATE	NAME
120477	9805	Thread Nipper Timing Gauge.....

THREAD UNWINDER

FOR ONE SPOOL

NO.	PLATE	NAME
225389	3398	Spool Rest with 201018c.....
225388	3398	“ “ Rod.....
200383c	S493	“ “ “ Set Screw.....
201018c	S493	“ “ “ Set Screw.....
202490	3398	“ Stand with 200383c.....
225391	3398	Thread Guide.....
201696j	S493	“ “ Lock Nut.....
225392	3398	“ “ Rod with 208E and 225392
208E	S494	“ “ “ Screw.....
225393	S493	“ “ “ Washer.....
225394	3398	Thread Unwinder complete, Nos. 201696j, 202490, 225388, 225389, 225391, 225392 and three wood screws 7/8 in. No. 12...
27739	7234	Thread Cone (wood) for large cones....
225390	7234	“ “ “ Holder, for inverted cones..

NOTE: Nos. 27739 and 225390 are used with, but not included in 225394

UNDER DRIVER

LEVER PRESSURE (RIGHT HAND) ONE SPEED (GROOVED PULLEY)

NO.	PLATE	NAME
126572	7980	Belt Guard.....
50058D	7978	“ “ Screw.....
126573	7978	Brake (thermoid).....
126791	9807	“ Lever with 50058D, 51067C and two 60823.....
423C	9804	Brake Lever Adjusting Screw.....
60823	—	“ “ “ “ 423C with 1520R.....
1520R	8495	Brake Lever Adjusting Screw Nut.....
51067C	7978	“ “ Set Screw.....
126575	7980	“ “ Spring.....
126169	9807	Driving Pulley (right hand) 6 $\frac{3}{4}$ in. diam., with 60911, 60935, 126202 and two 126895.....
60911	9807	Driving Pulley Friction Ring (leather)...
60935	7978	“ “ “ “ Stop Pin...
126756	9803	“ “ Shaft (hollow) right hand
126576	—	“ “ “ 126756 with 204107, 204108 and eleven 25303.....
126577	—	Driving Pulley Shaft complete, Nos. 126173, 126175, 126576, 126578 and 126757.....
25303	7978	Driving Pulley Shaft Ball, size $\frac{1}{4}$ in.
204107	7979	“ “ “ “ Cup.....
204108	7979	“ “ “ “ “ Cap.....
126173	7978	“ “ “ Oiling Leather.....
126175	7978	“ “ “ “ “ Plug (leather).....
126757	9805	Driving Pulley Shaft Oiling Leather Clip
126578	7980	“ “ “ “ Wick.....
50959C	7978	“ “ “ Set Screw.....
204113	7978	“ “ “ Thimble.....
126895	9805	“ “ Spring.....
126201	7979	“ “ “ Retaining Washer
126202	—	Driving Pulley Spring Retaining Washer complete, Nos. 126201 and 126203.....
126203	7978	Driving Pulley Spring Retaining Washer Pin.....
126579	9807	Frame with 50959C.....
126179	9807	Friction Pulley (right hand) with 227553 and four 50512E.....

NO.	PLATE	NAME
25362	7978	Friction Pulley Ball, size $\frac{3}{8}$ in.
204100	7979	“ “ “ Bearing Cup.....
204101	7979	“ “ “ Cap.....
204102	7979	“ “ “ Retaining Spring...
227553	—	Friction Pulley Ball Cup complete, Nos. 204100 to 204102 and thirteen 25362..
126792	9807	Lever (compression) and Dress Guard with 200524C, 204117 and two 202845
200524C	7978	Lever (compression) and Dress Guard Set Screw.....
204117	7979	Lever Compression Plate.....
202845	7978	“ “ “ Rivet.....
126580	9803	“ Shaft.....
123183	7978	“ “ Cotter Pin.....
60489	9807	Pulley (grooved) 4 in. diam.,.....
50512E	7978	“ Screw.....
27070	8497	Shaft Driving Pulley (sectional) 10 in. diam., 1 $\frac{1}{2}$ in. face, 1 $\frac{1}{8}$ in. bore, with two 597C.....
597C	8474	Shaft Driving Pulley Clamping Screw....
126036	8497	Treadle.....
126037	—	“ 126036 with 2718R, 50581R and 126038.....
126205	8497	Treadle Bracket (left).....
126207	8493	“ “ “ Hook.....
23258	8493	“ “ “ “ Friction Washer.....
126208	8493	Treadle Bracket (left) Hook Rivet.....
126206	—	Treadle Bracket (left) complete, Nos. 23258, 126205, 126207, 126208 and two wood screws 1 in. No. 14.....
46681	8497	Treadle Bracket (right).....
60502	—	“ “ “ 46681 with two wood screws 1 in. No. 14.....
126038	8497	Treadle Extension.....
50581R	8495	“ “ Screw.....
2718R	8493	“ “ “ Washer.....
60858	8497	“ Hanging Hook.....
27639	8497	“ Pitman Rod.....
9079	8497	“ “ “ Clamp with 354C...
354C	8474	“ “ “ “ Screw.....
60626	8497	Treadle Pitman Rod complete, two each Nos. 9079 and 27639.....
126211	—	Treadle complete, Nos. 60502, 126037 and 126206.....
126212	—	Treadle and Pitman complete, Nos. 60626, 60858 and 126211.....

UNDER DRIVER

NO.	PLATE	NAME
126581	—	Transmitter complete, to fasten to table, Nos. 60489, 123183, 126169, 126179, 126572, 126573, 126575, 126577, 126579, 126580, 126791, 126792, 204113 and three wood screws $1\frac{3}{4}$ in. No. 16.....
126582	—	Under Driver, lever pressure (right hand) one speed (grooved pulley) complete, Nos. 27070, 126212 and 126581.....

Genuine Singer Needles and their Containers are marked with the Company's Trade Mark "SIMANCO." 1

Needles in Containers marked "For Singer Machines" are not Singer made needles. 2

PLATE 3398—ONE-SIXTH SIZE

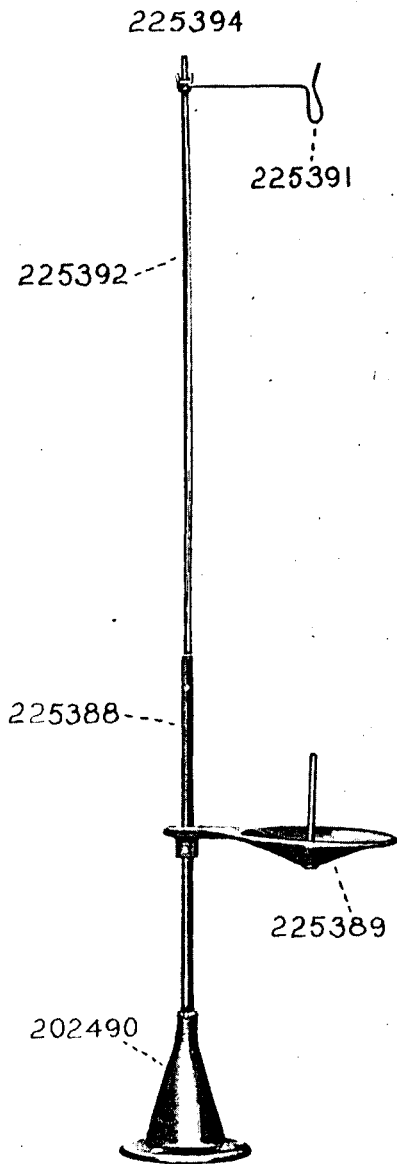


PLATE 7234—ONE-HALF SIZE

27739



225390

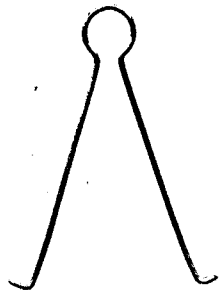


PLATE 7978—FULL SIZE

51068



50959



50512



200524



51067



25362



25303



126175



50058



50288



126173



55767



27414



126203



123183



202845



126573



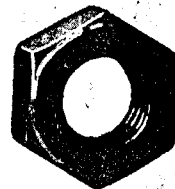
60935



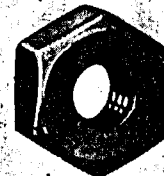
204113



1595



1796



51541



PLATE 7979—FULL SIZE

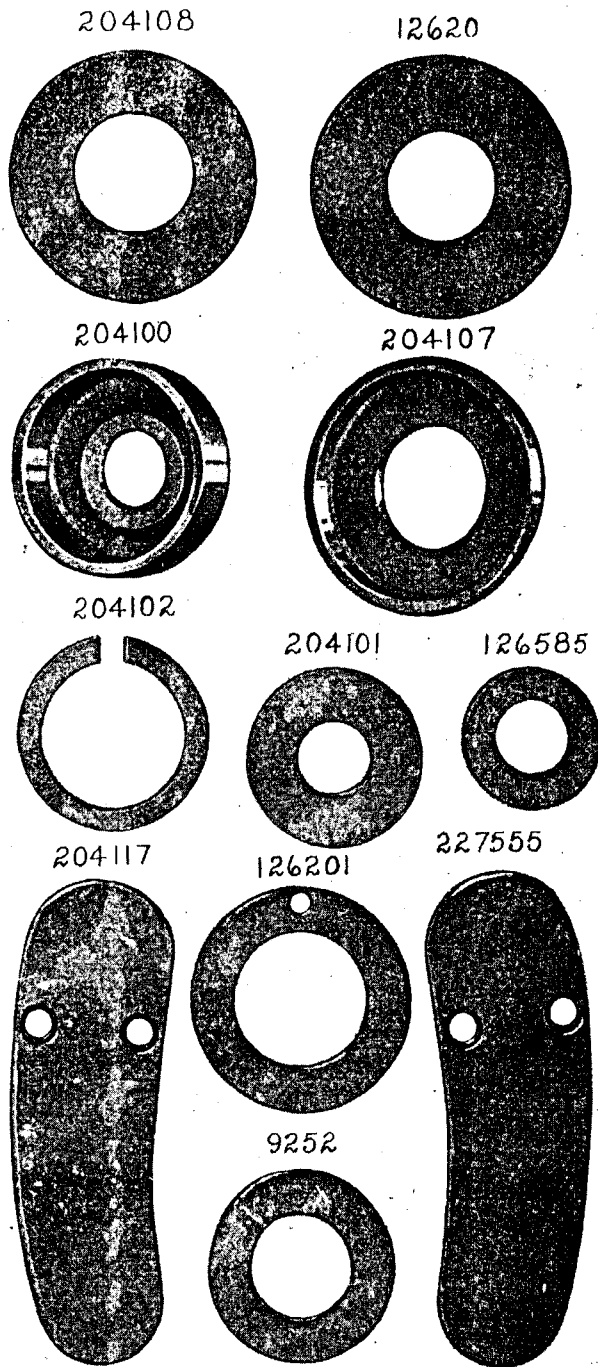


PLATE 7980—ONE-HALF SIZE

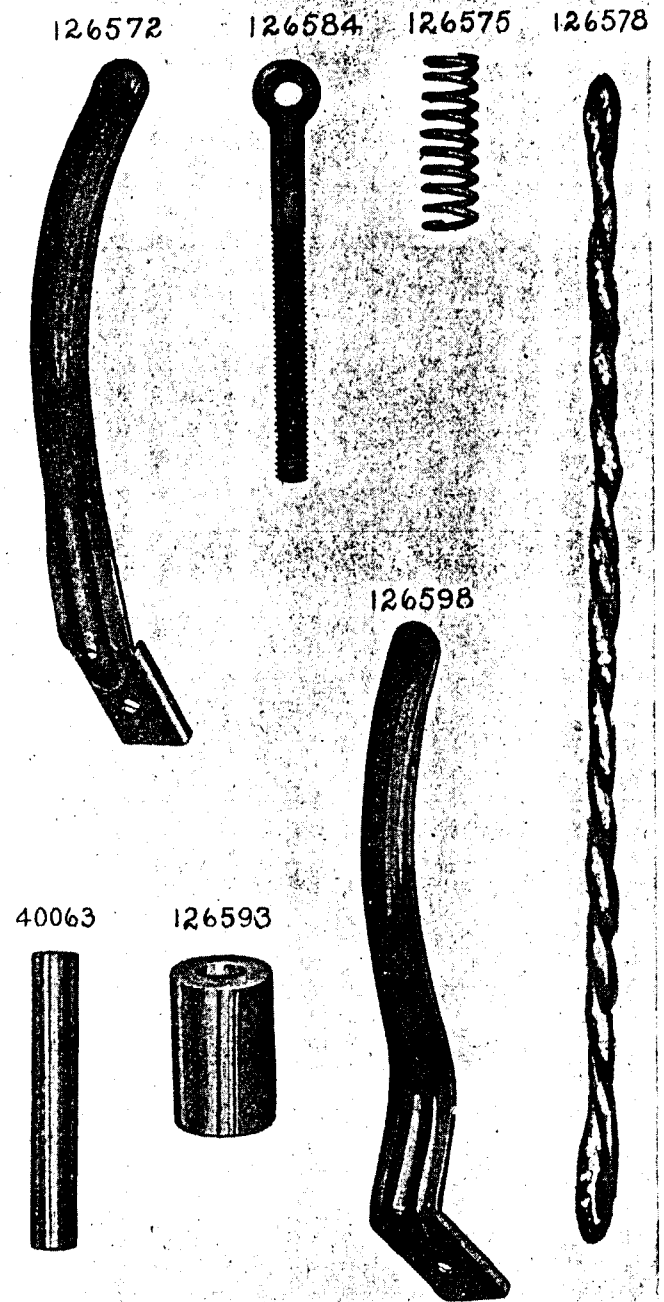


PLATE 8473—FULL SIZE

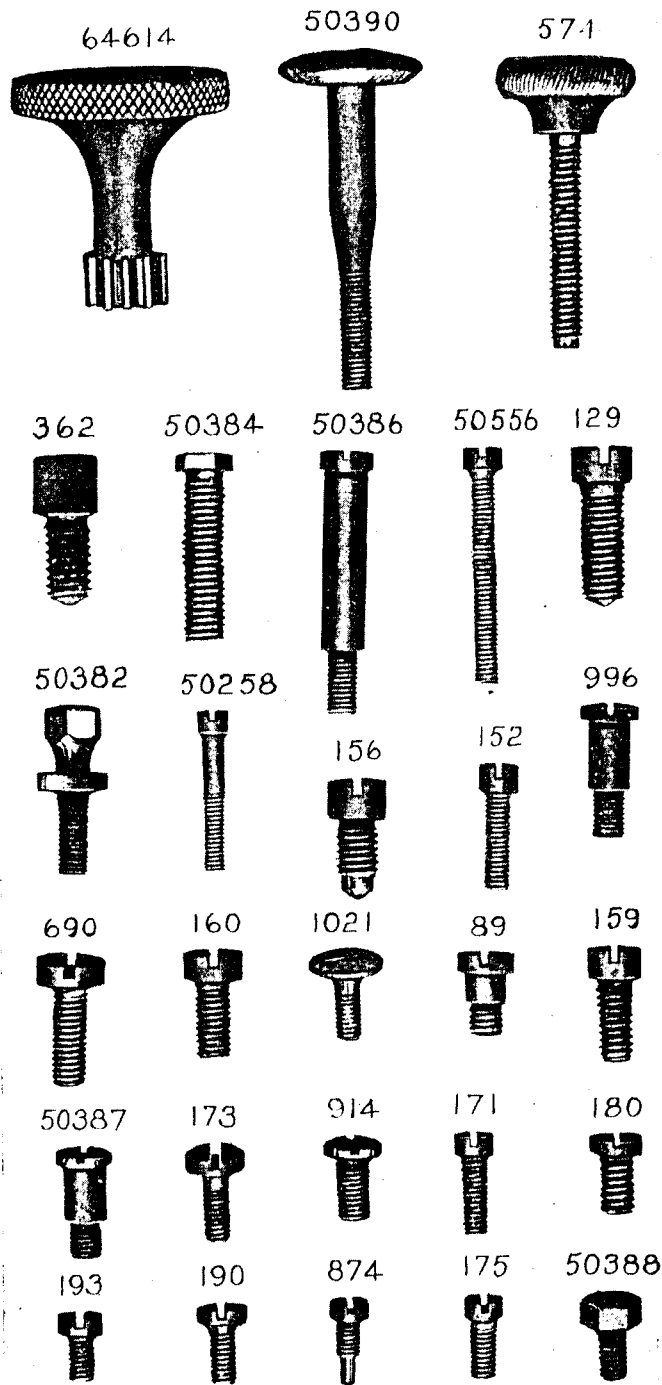


PLATE 8474—FULL SIZE

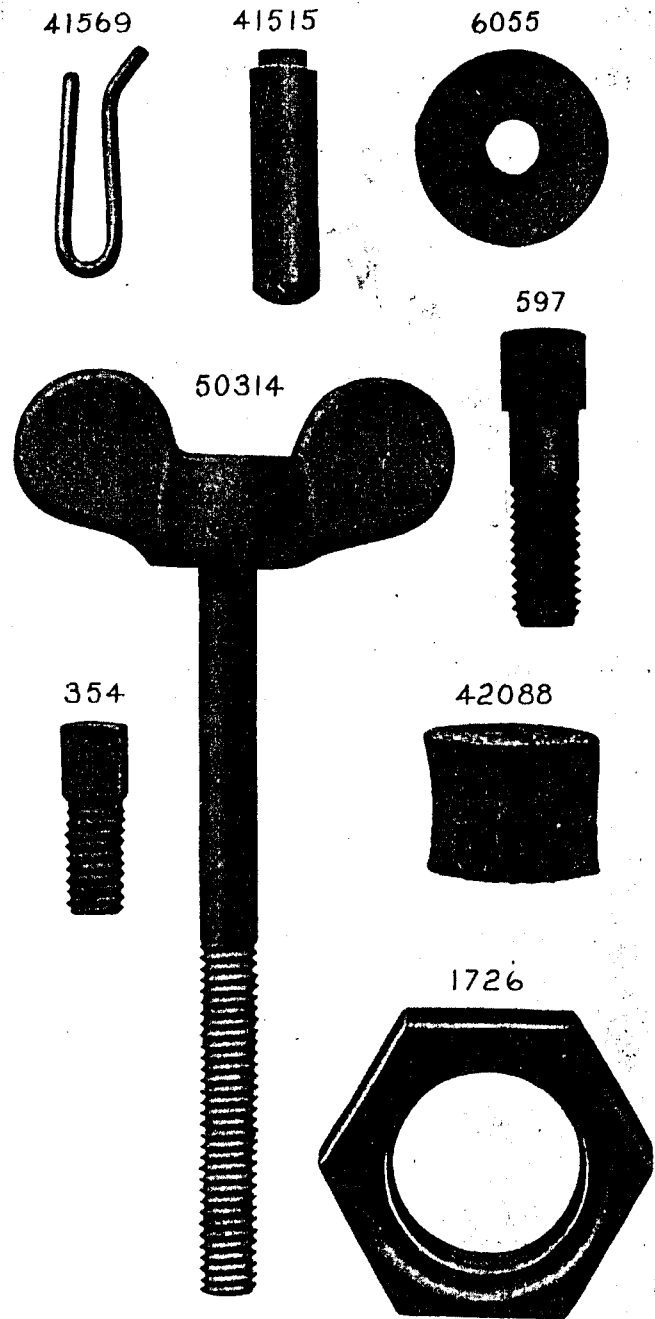


PLATE 8475—ONE-HALF SIZE

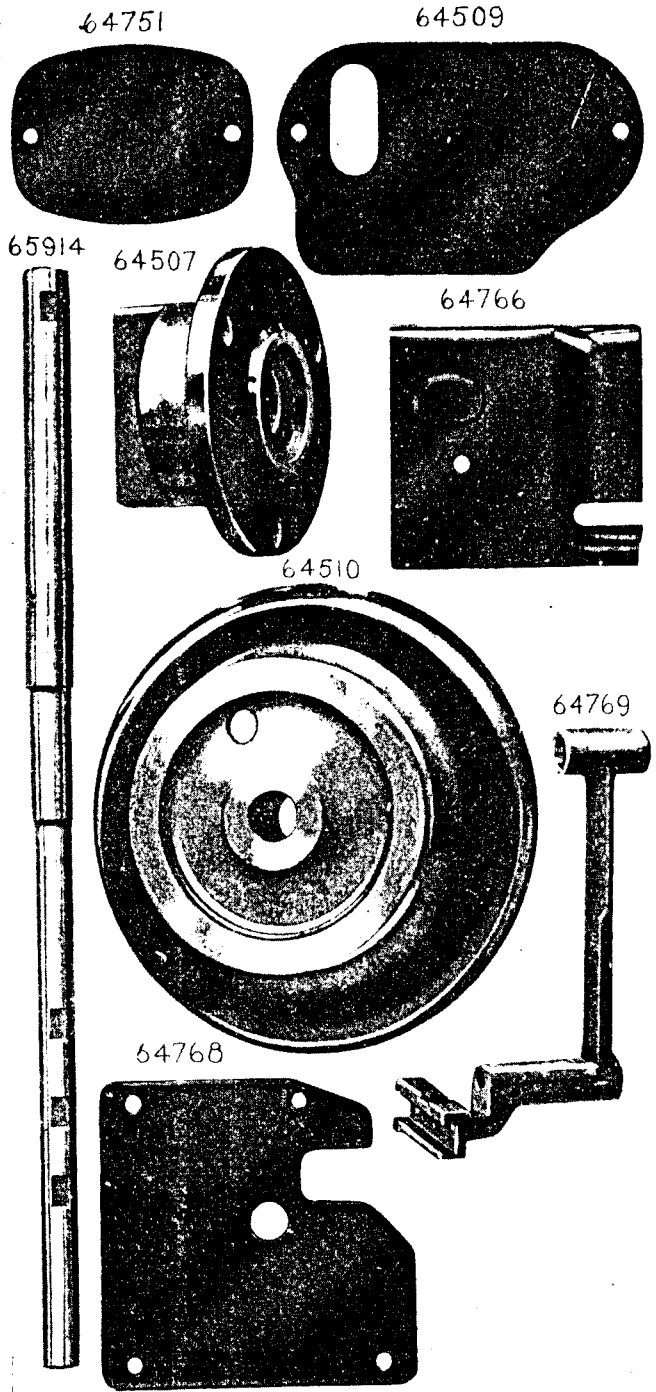


PLATE 8476—FULL SIZE

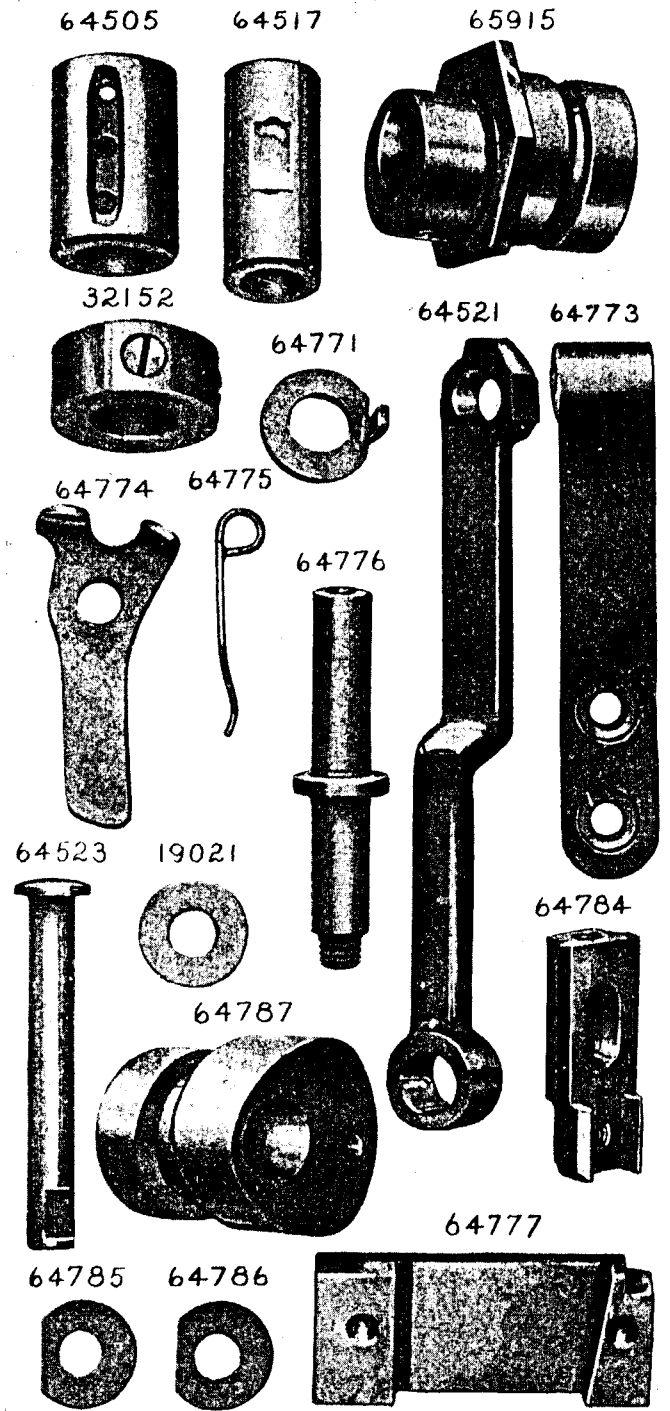
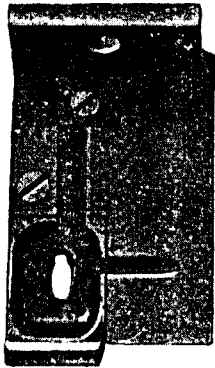


PLATE 8481—FULL SIZE

65866



64783



65879

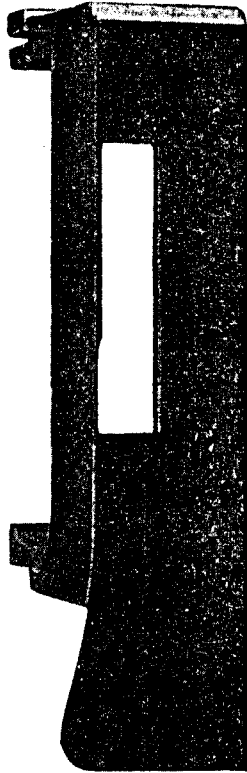
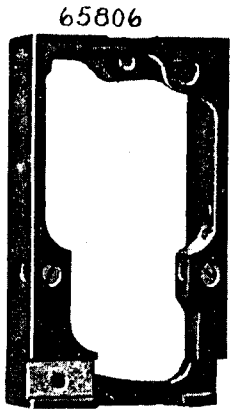
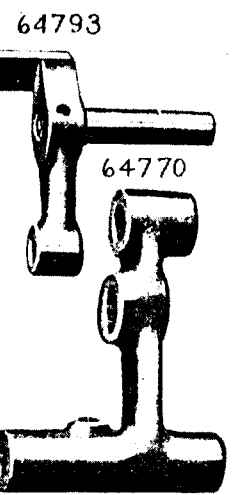


PLATE 8482—ONE-HALF SIZE

64635 65816 64589 64516



64793

64579

64770

65806

65817

65847

64508

64573

PLATE 8483—FULL SIZE

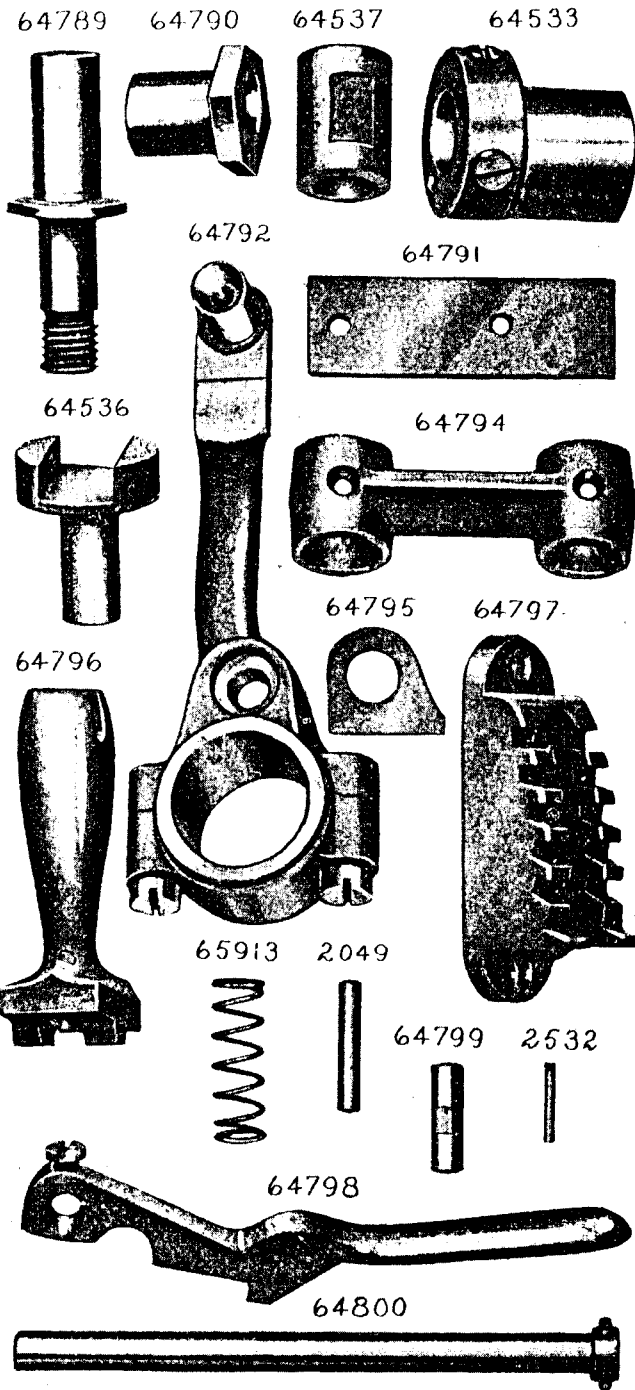


PLATE 8484—FULL SIZE

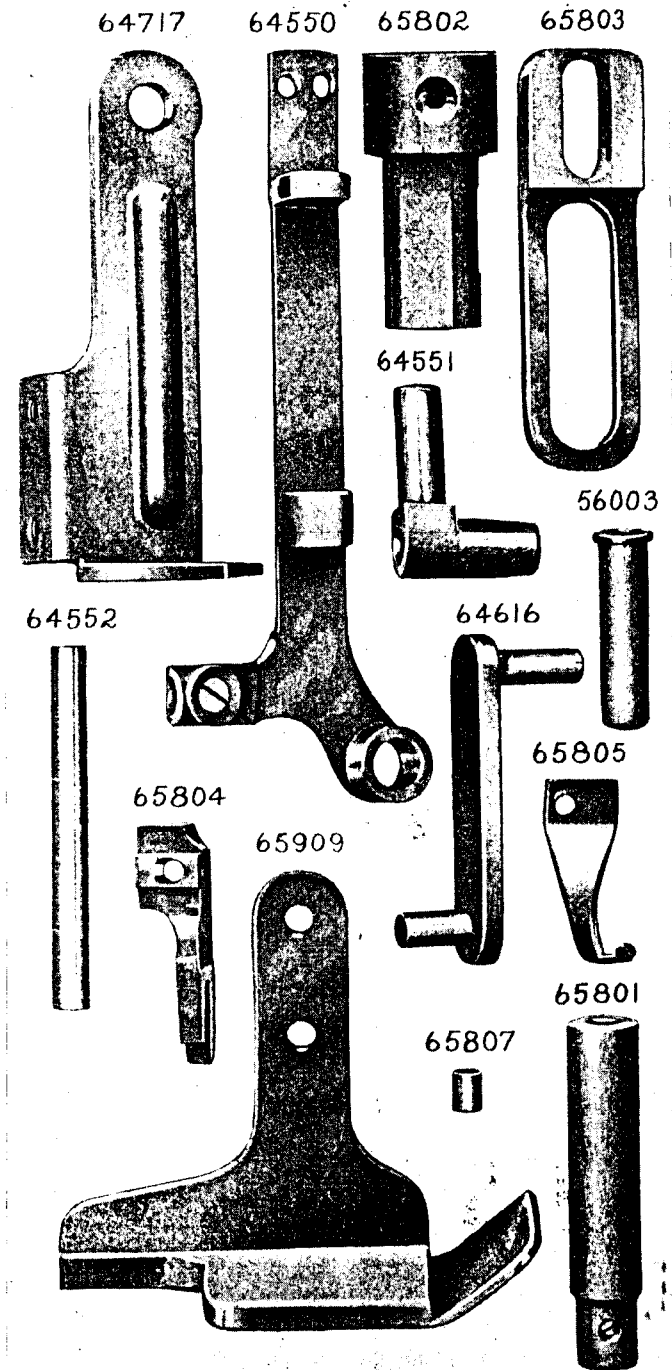


PLATE 8485—FULL SIZE

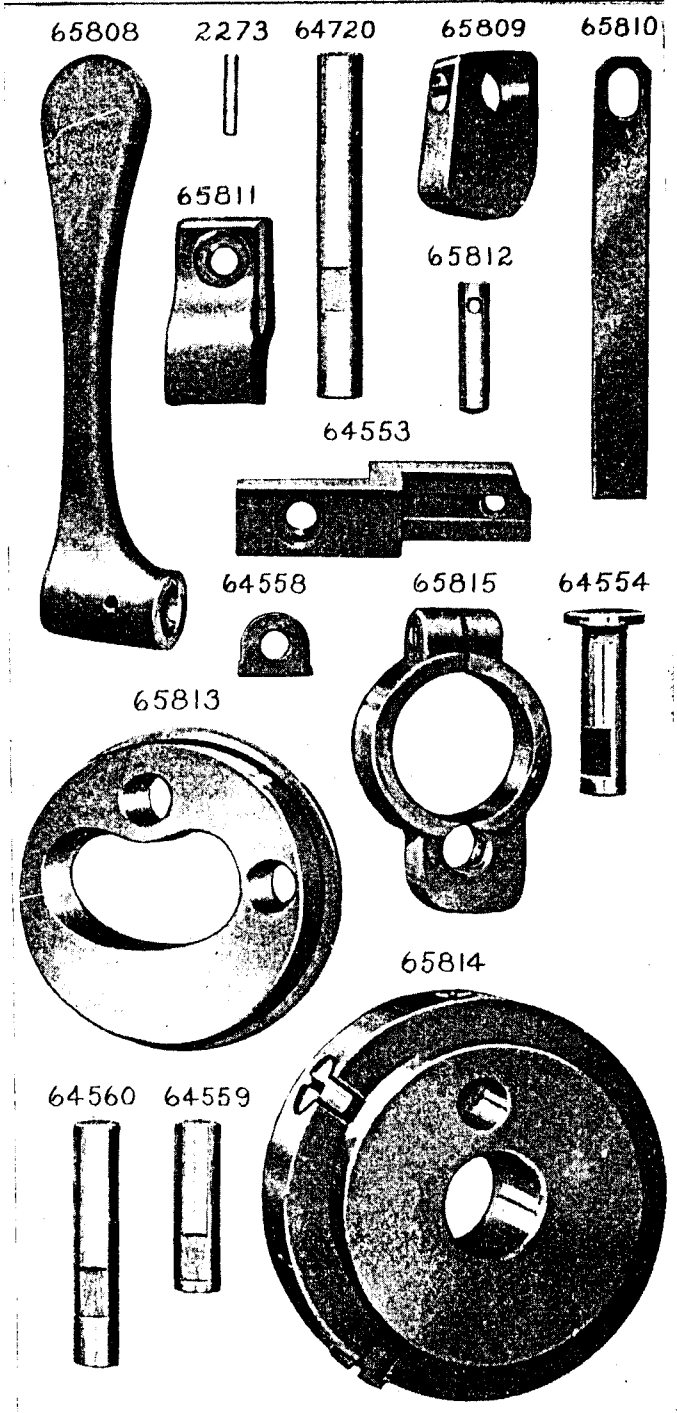


PLATE 8486—FULL SIZE

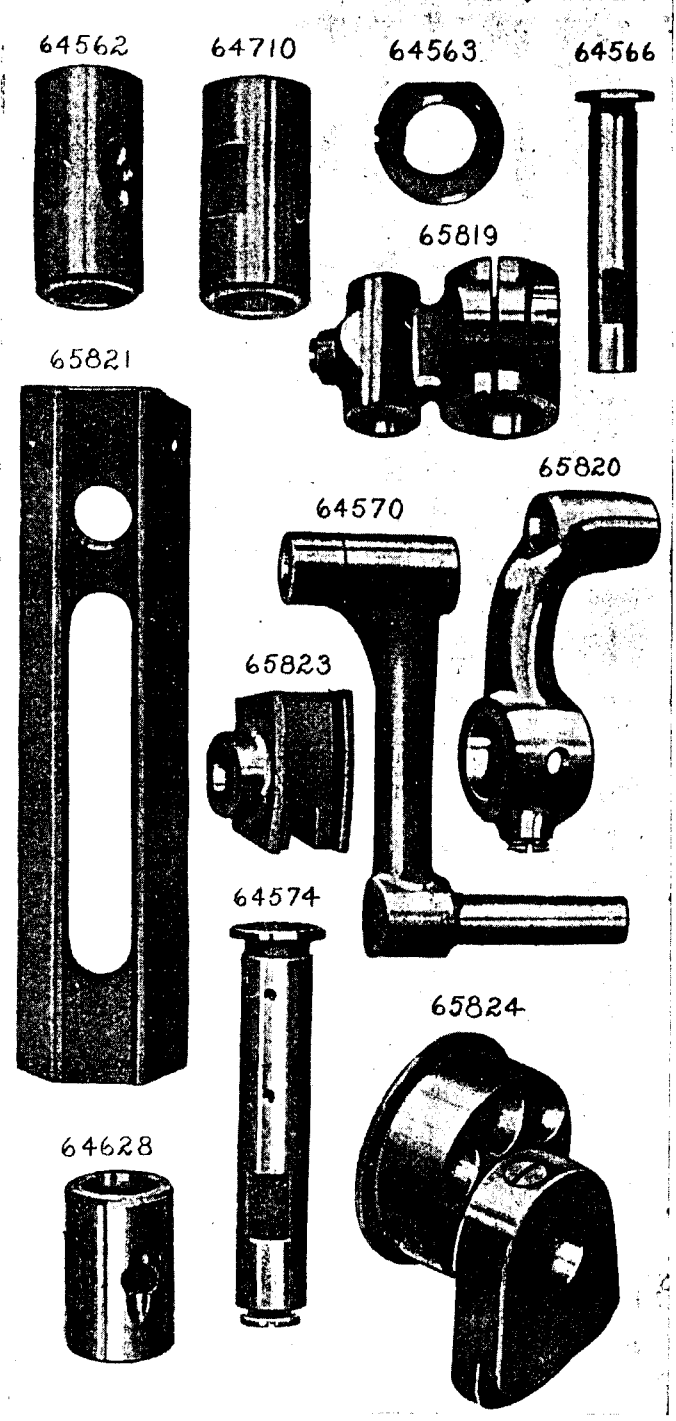


PLATE 8487—FULL SIZE

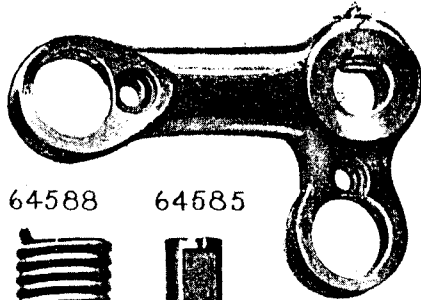
65826



24833



65828



64588



64585



5923



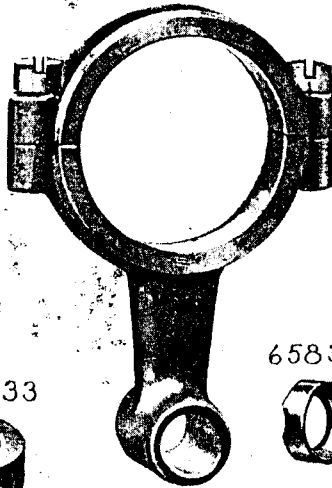
64590



65831



64576



65830



64587



PLATE 8488—FULL SIZE

64591



64592



64593



64758



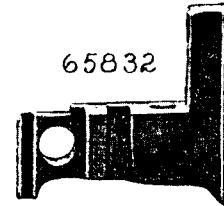
65834



64594



65832



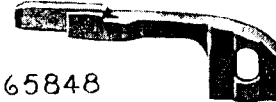
65838



1779



65835



65836



65848



64622 13090



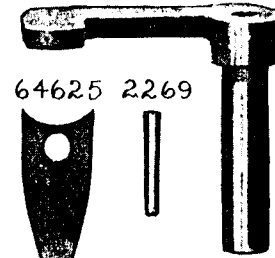
64626



64618



64623



64624



64625 2269



64762



PLATE 8489—FULL SIZE

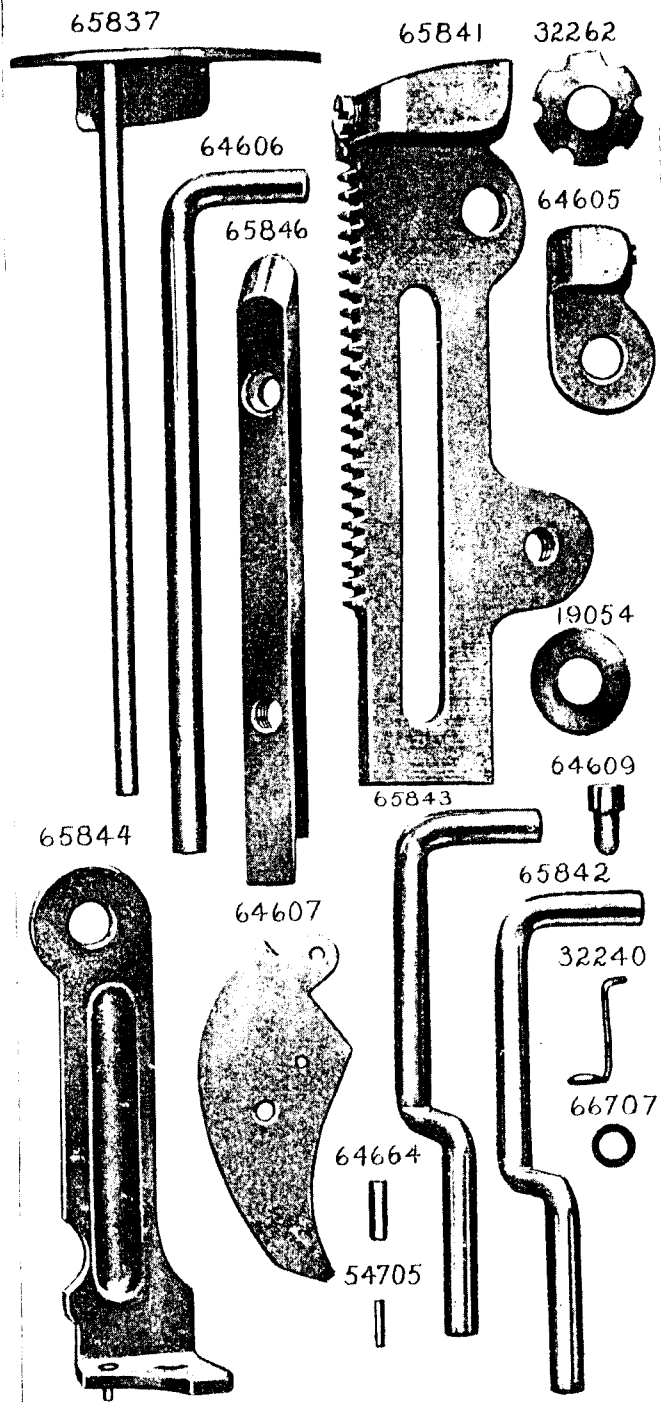


PLATE 8490—ONE-HALF SIZE

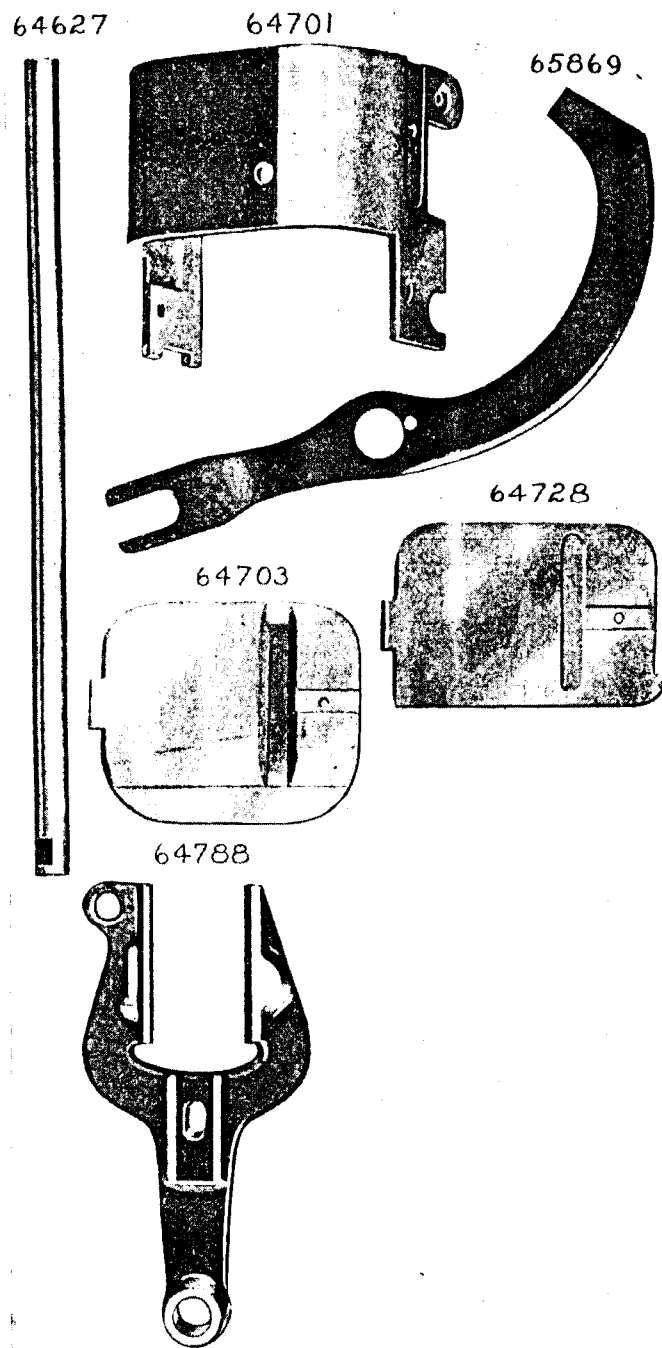


PLATE 8491—FULL SIZE

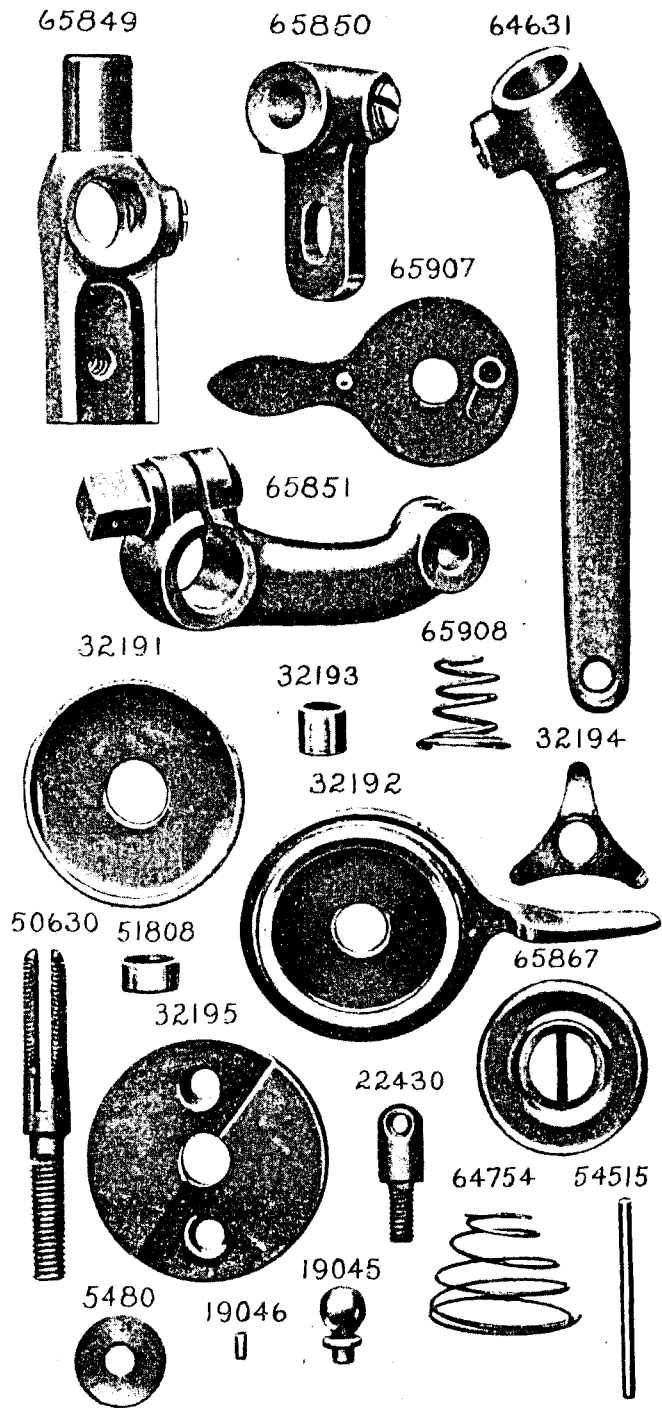


PLATE 8492—FULL SIZE

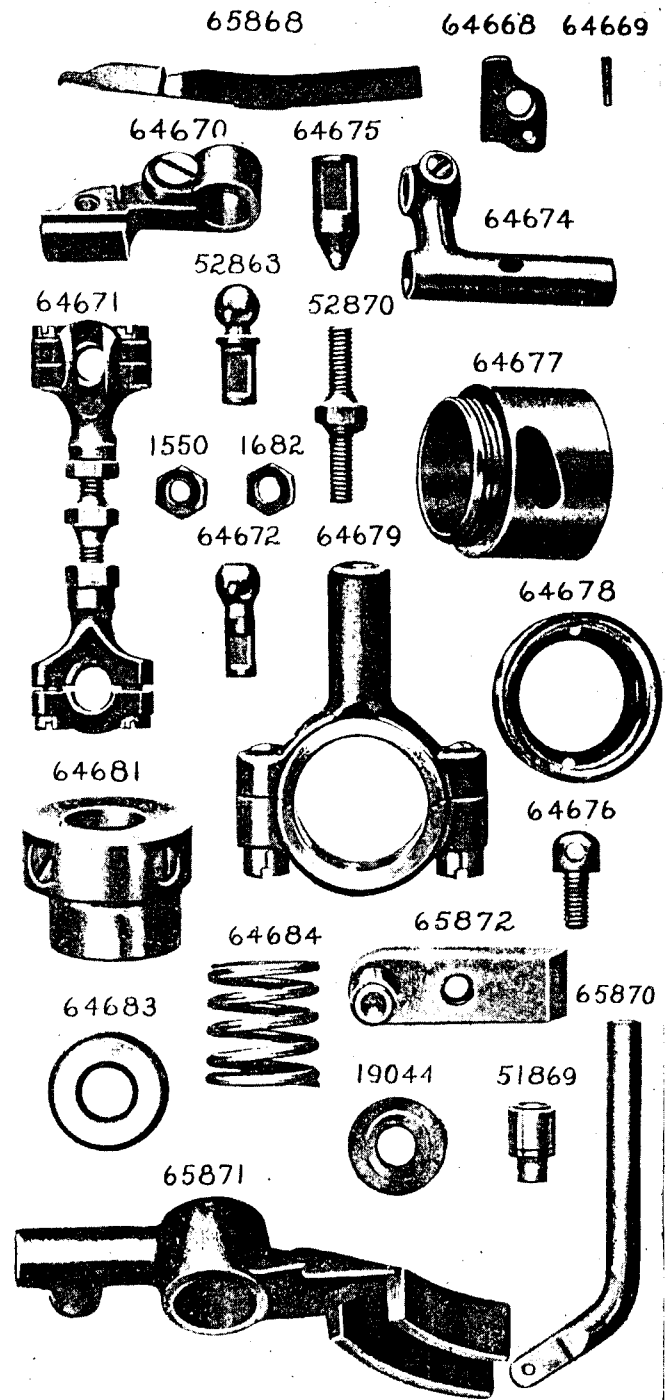


PLATE 8493—FULL SIZE

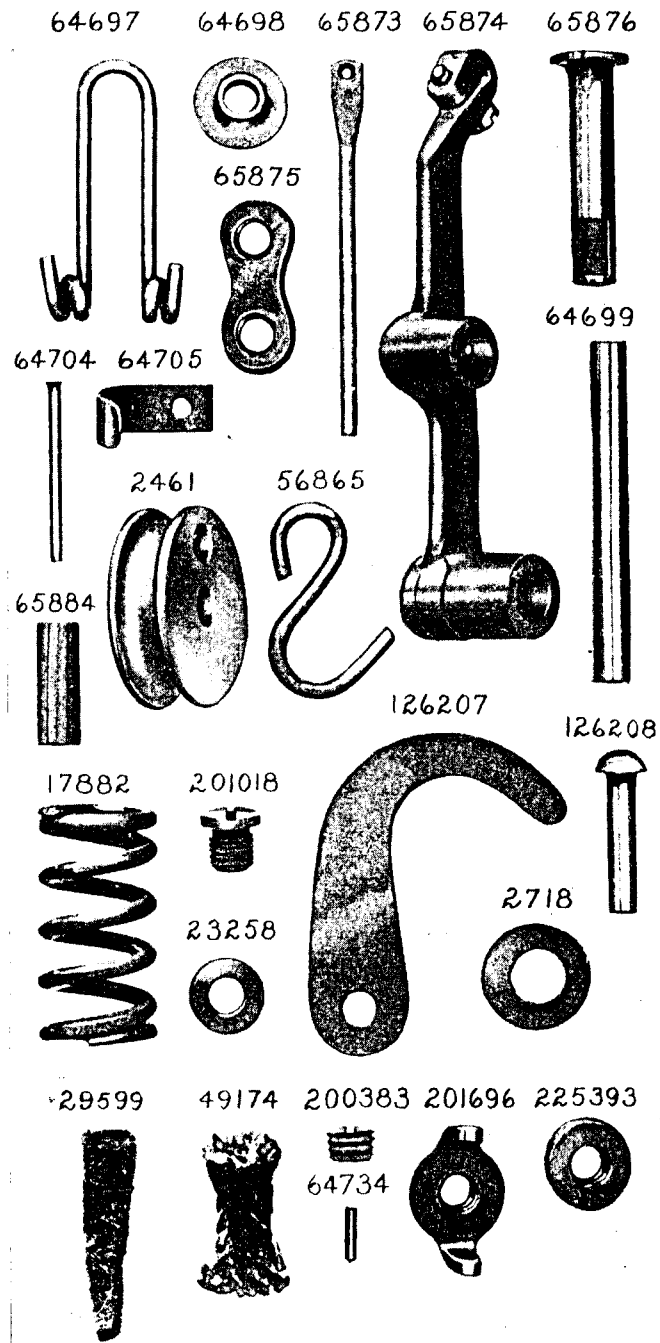


PLATE 8494—FULL SIZE

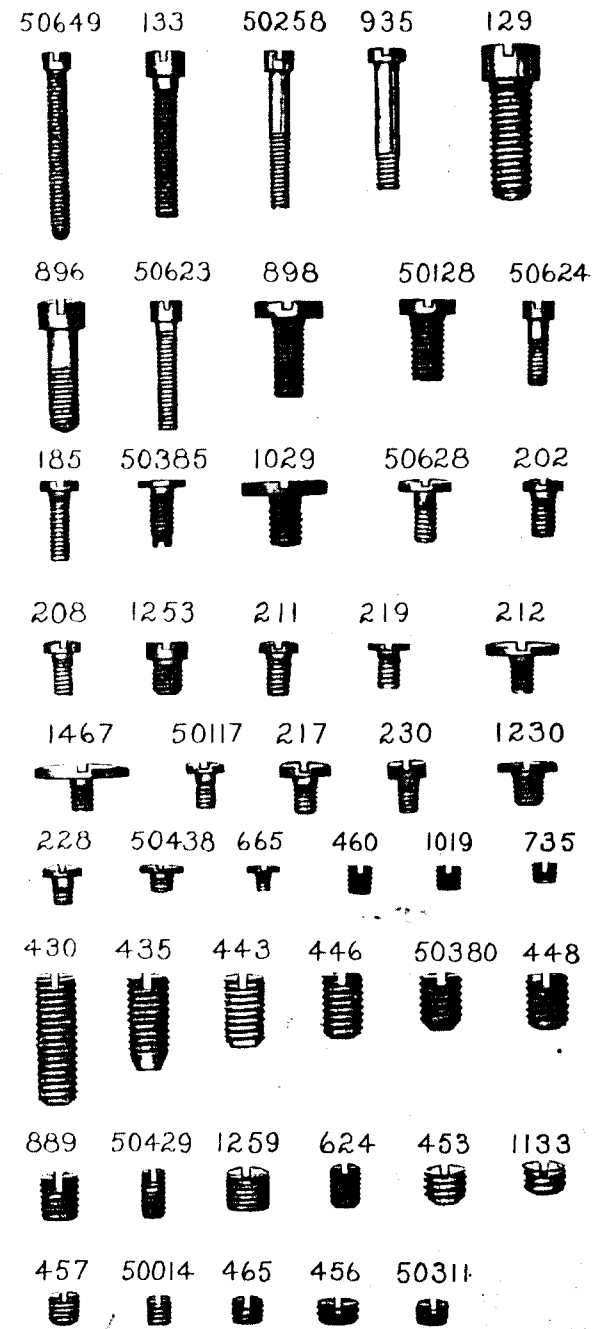


PLATE 8495—FULL SIZE

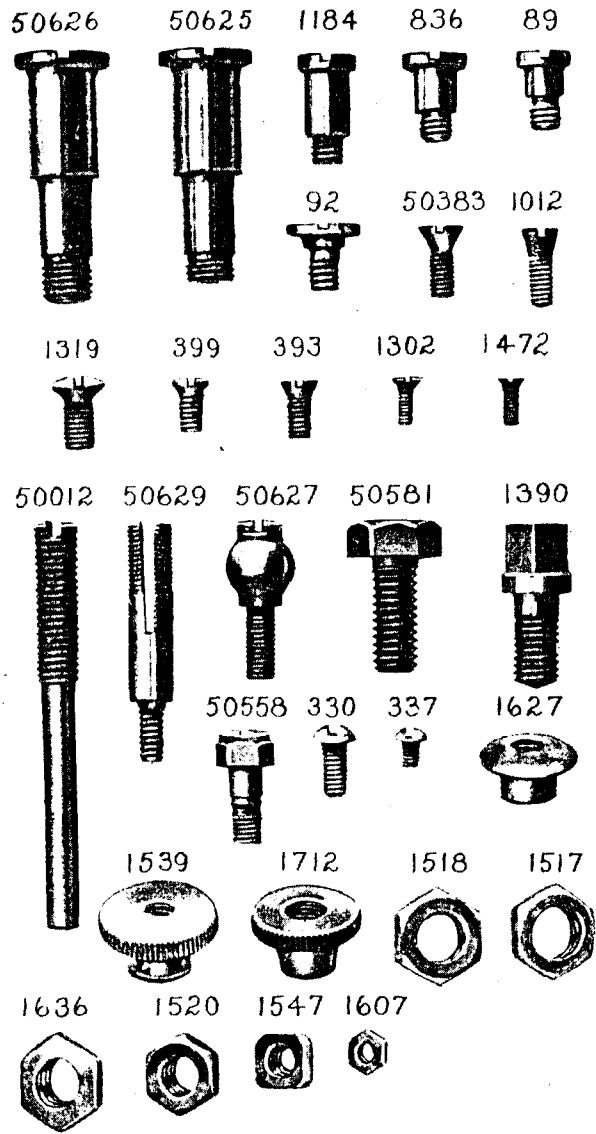


PLATE 8496—ONE-HALF SIZE

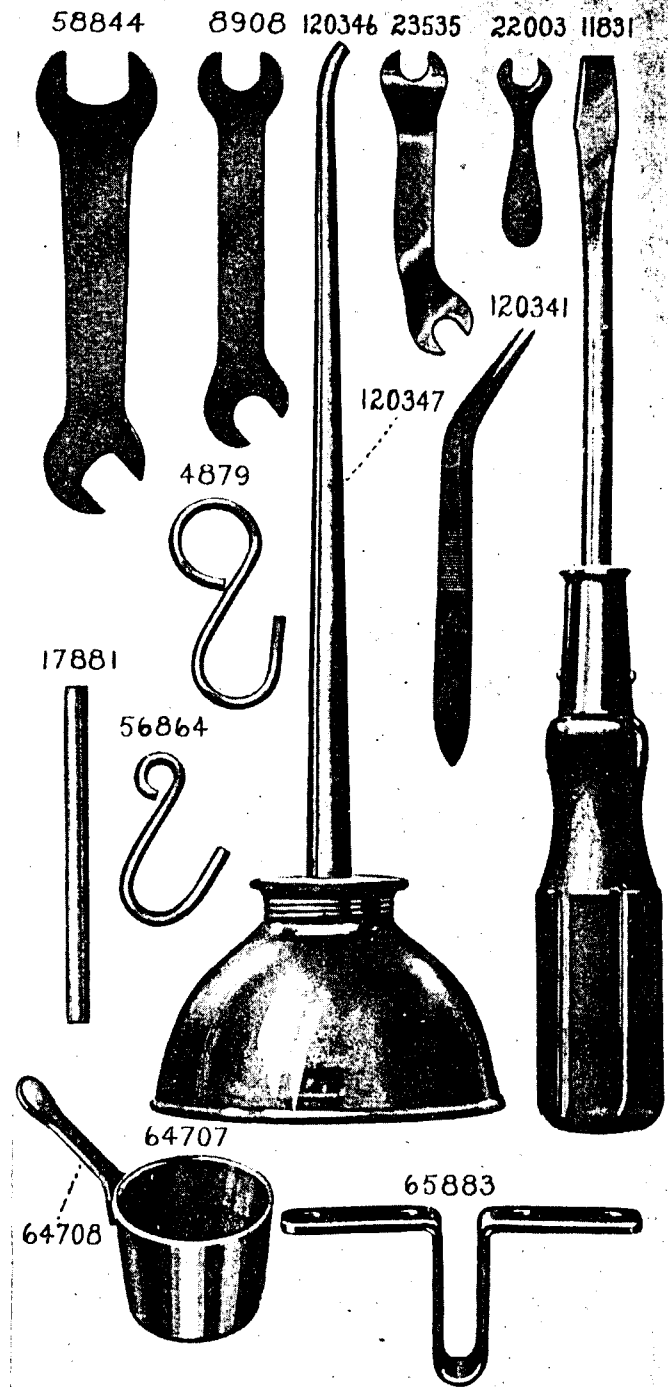
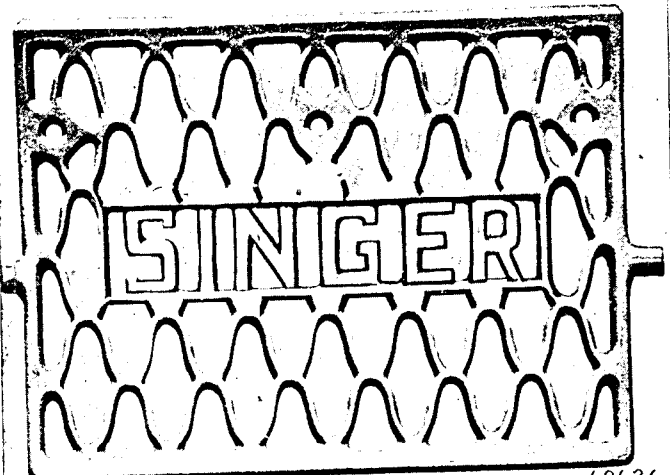


PLATE 8497—ONE-FOURTH SIZE

126036



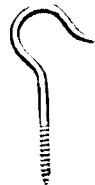
126038



126205



60858



46681

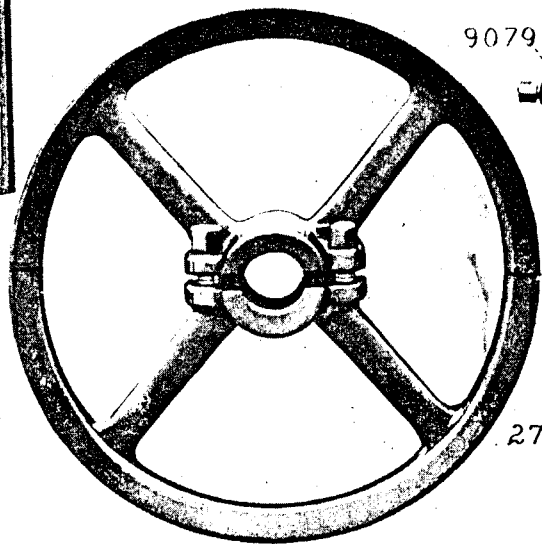


60626

27639

27070

9079



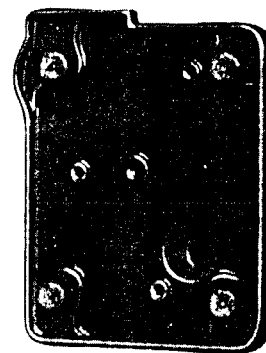
27639

PLATE 8498—ONE-SIXTH SIZE

41046



64706



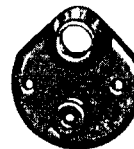
17884



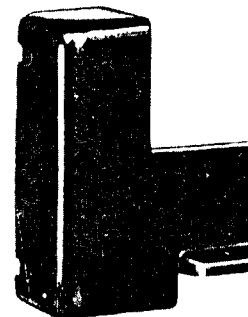
17876

17883

41044



64772



41045

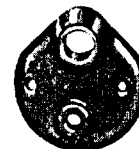


PLATE 8499—FULL SIZE

65937



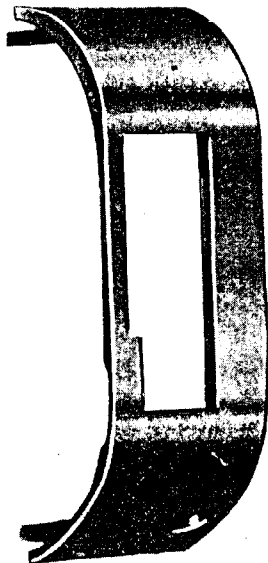
65950



65936



65877



64778

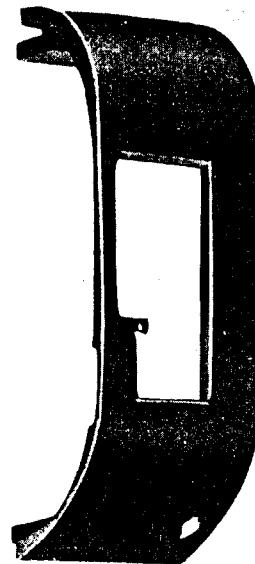


64779



PLATE 9800—FULL SIZE

65951



65941



65944



65943



65939



65938 65942

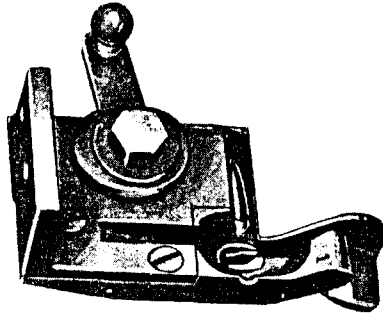


65940 1367

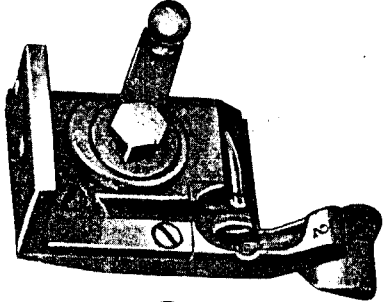


PLATE 9801-FULL SIZE

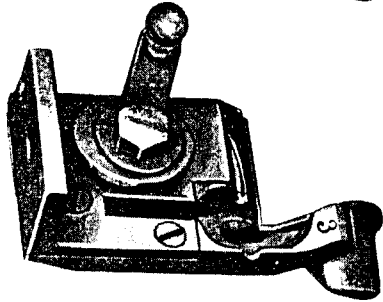
65962



65963



65964



65965

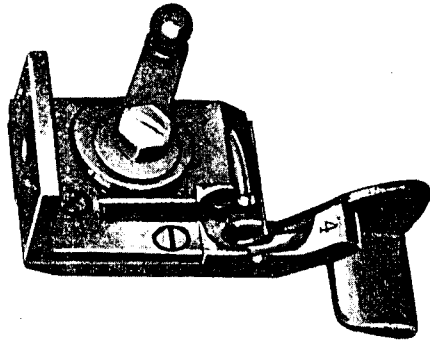
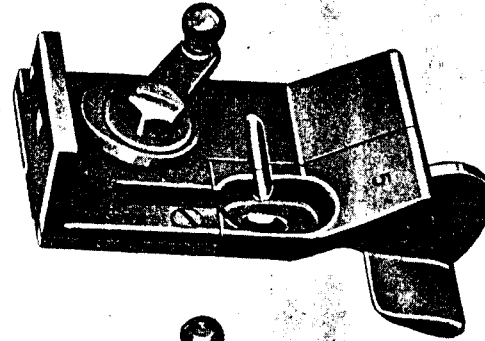
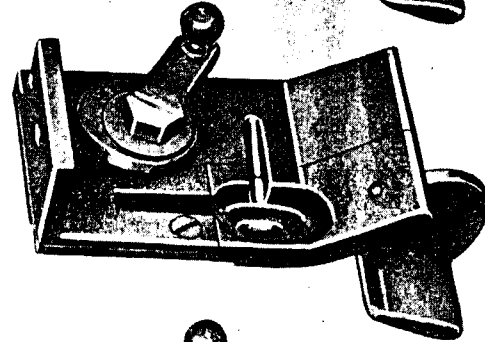


PLATE 9802-FULL SIZE

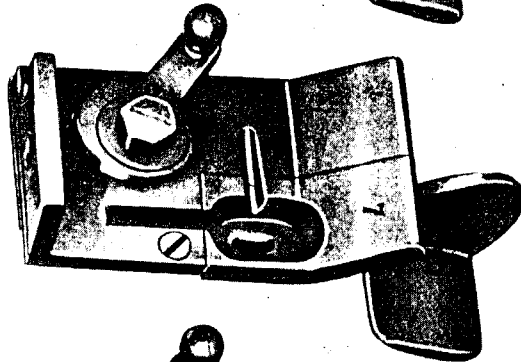
65978



65979



65980



65981

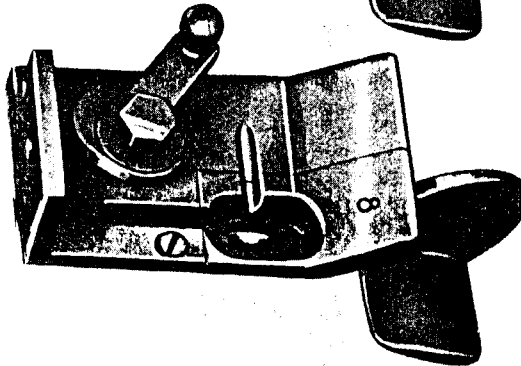


PLATE 9803—ONE-HALF SIZE

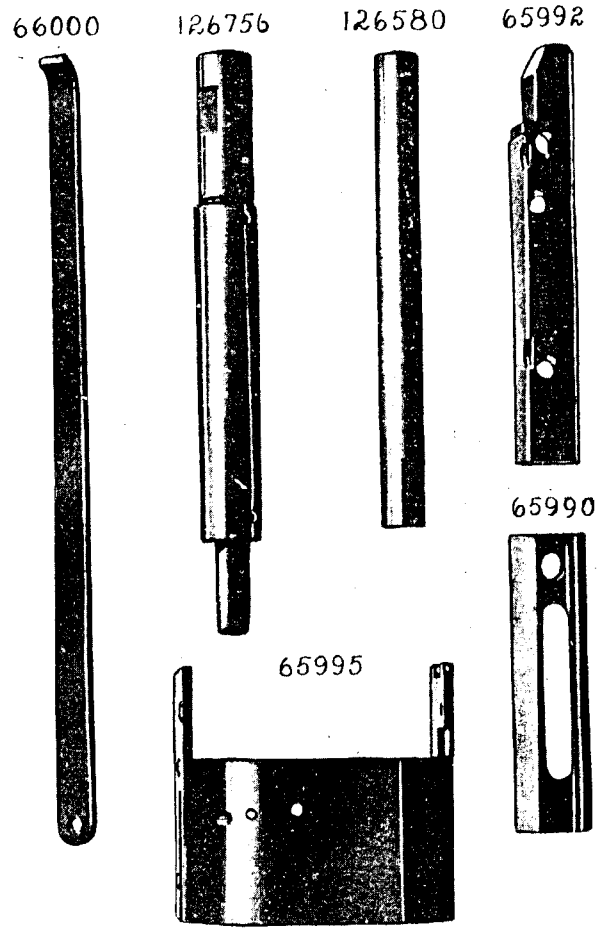


PLATE 9804—FULL SIZE

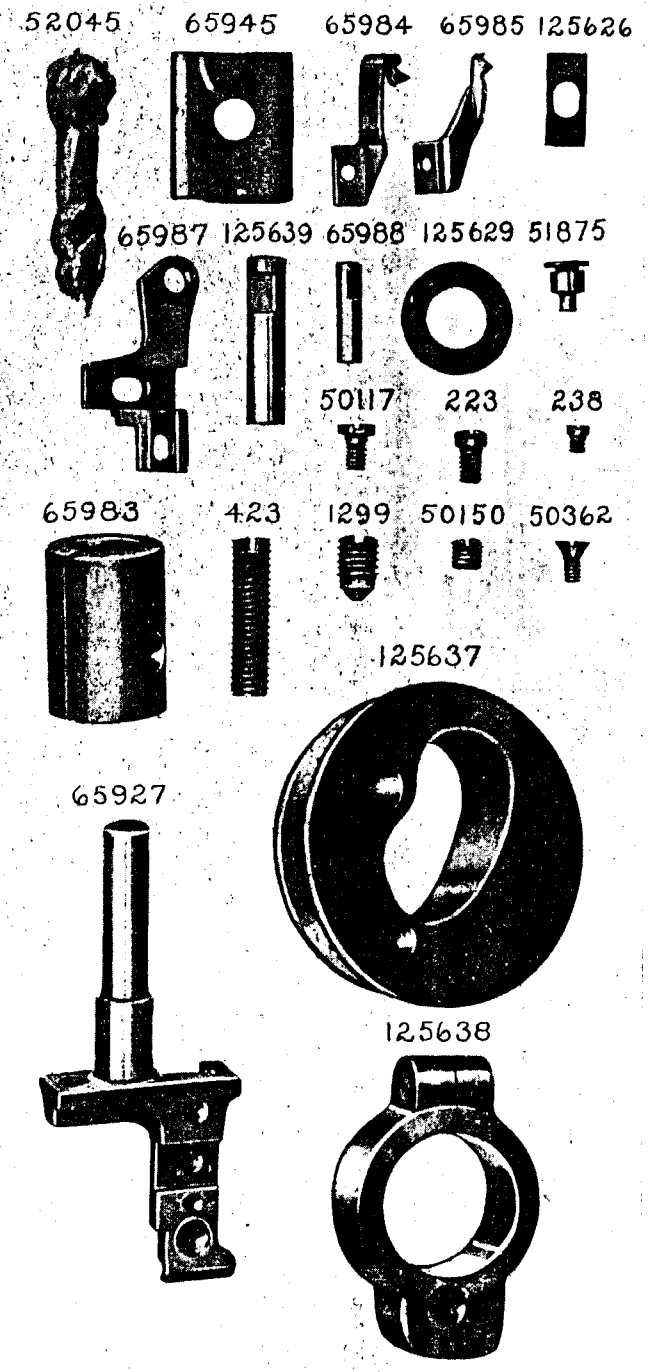


PLATE 9805—FULL SIZE

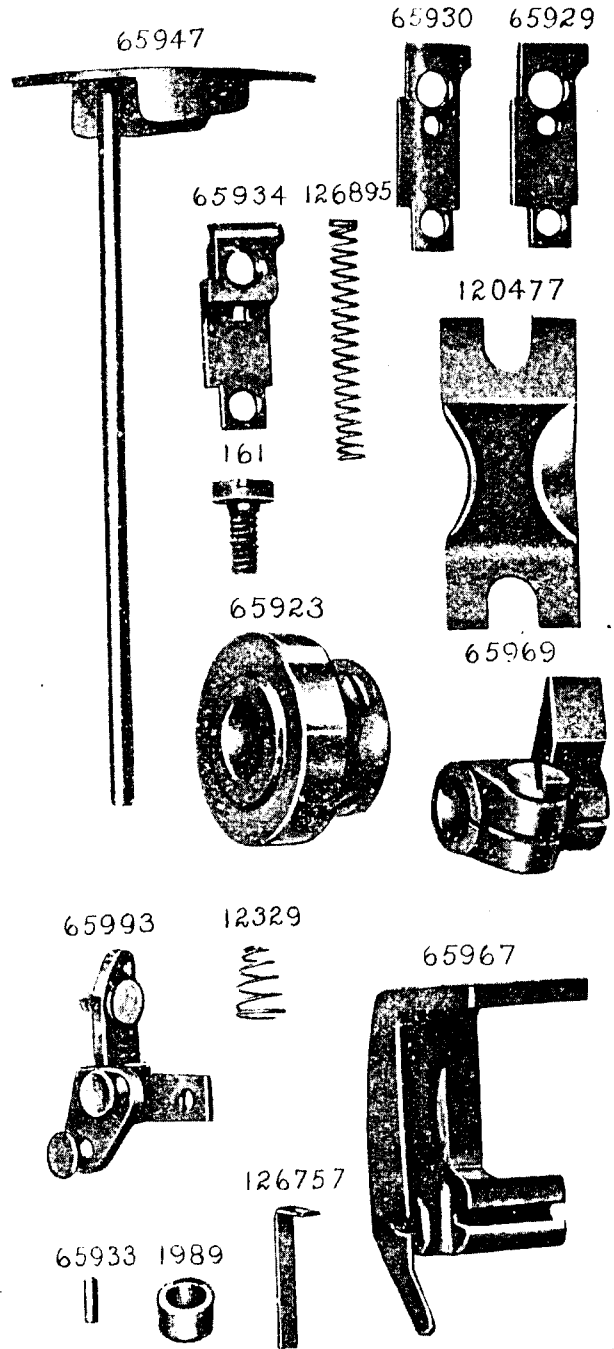


PLATE 9806—FULL SIZE

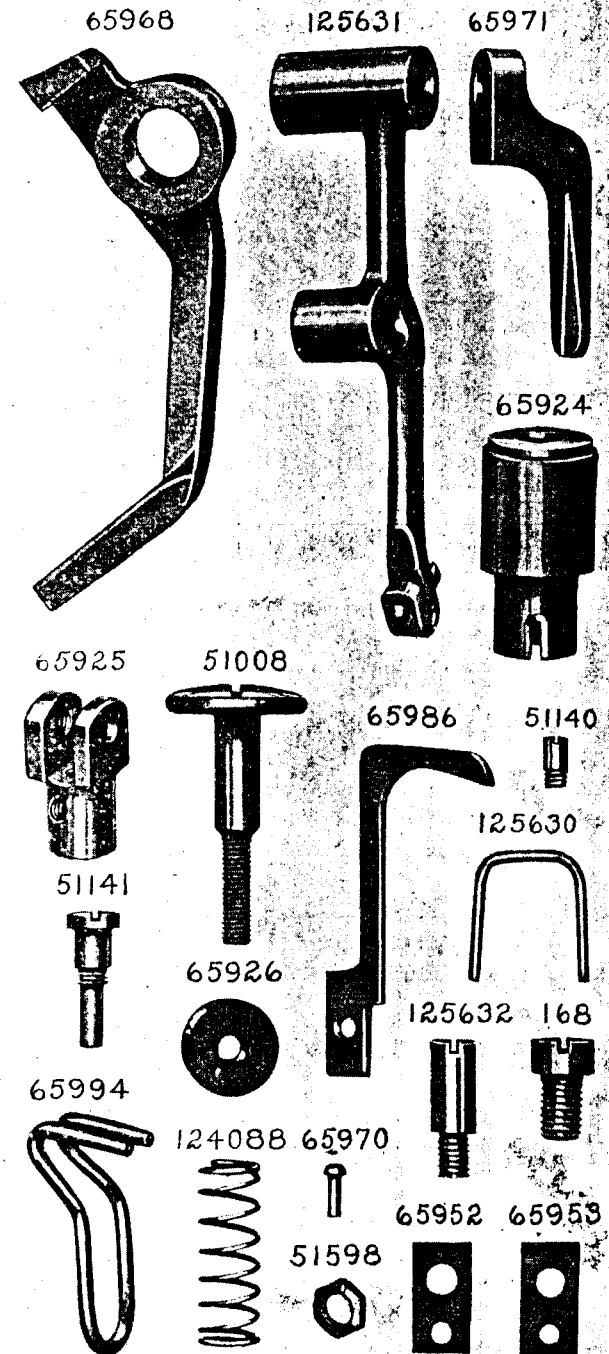
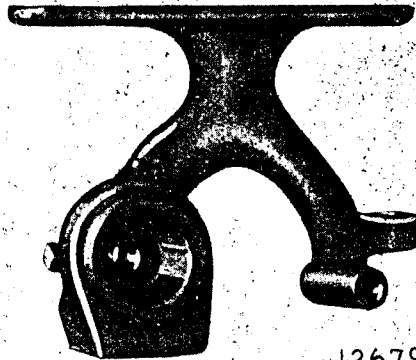


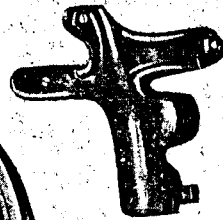
PLATE 9867—ONE-FOURTH SIZE

126579

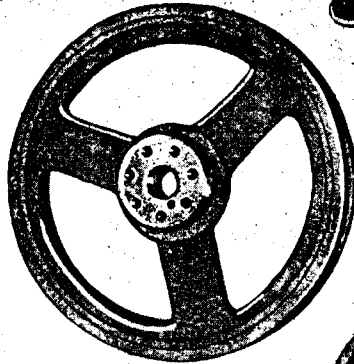


60911

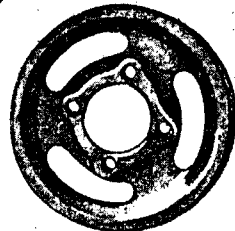
126791



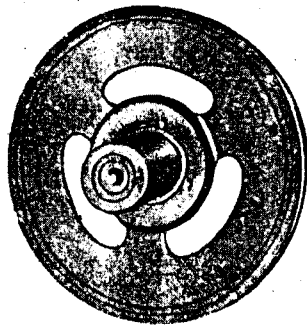
126169



60489



126179



126792

