

SINGER
144W204 AND 144W304

Form 2903W
Rev. (656)

INSTRUCTIONS
FOR USING AND ADJUSTING
SINGER
SEWING MACHINES

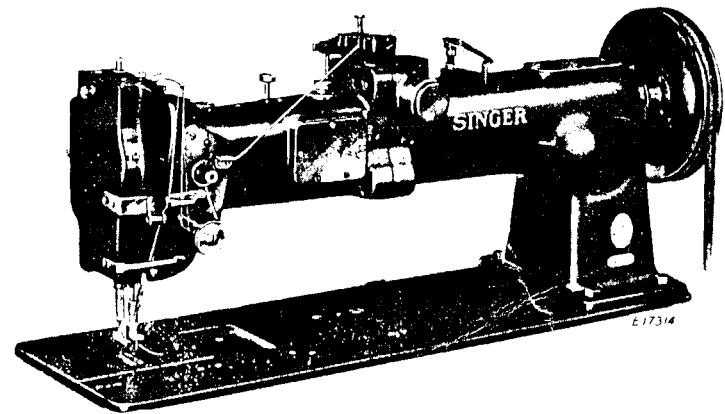

Machine 144w204

144w204 and 144w304

THE SINGER COMPANY

TO RE-ENGAGE THE SAFETY CLUTCH

The hook driving shaft and the shaft of the sewing hook are splined to prevent the hook from getting out of time. The safety clutch located at the junction of the hook driving shafts prevents damage in the event of any unusual strain on the sewing hook by releasing the locking lever in the safety clutch flange from the notch (K2, Fig. 25) in the collar of the hook driving shaft.

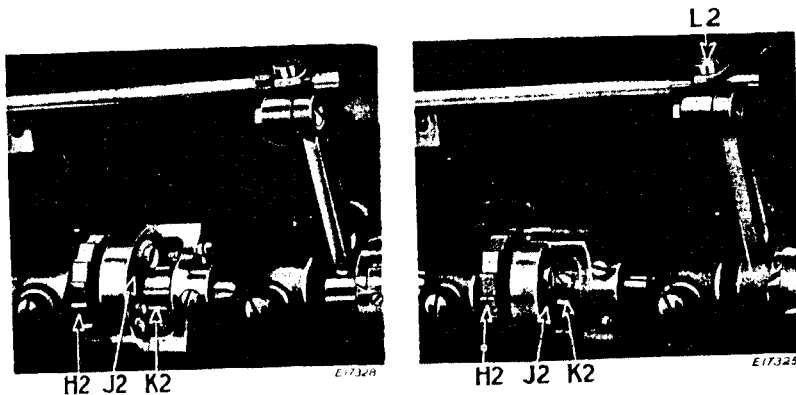

Fig. 25. Safety Clutch Disengaged

Fig. 26. Operating Position

To re-engage the clutch, draw back the bed slide, press down the lock stud (V, Fig. 14) to engage the hook driving shaft lock ratchet (H2, Fig. 25) which will prevent the hook driving shaft from turning backward. Turn the machine pulley away from you until the locking lever (J2) snaps into the notch (K2) in the shaft collar as shown in Fig. 26. Release the lock stud, turn the machine pulley back and forth to remove the material that may be jamming the hook and resume sewing.

DESCRIPTION

MACHINE 144w204 is a single needle lock stitch machine with compound feed and high-lift alternating pressers for automobile work, tents, awnings, furniture upholstery, etc. It has a belt-driven rotary sewing hook on a vertical axis and a high arm with a working space of 20 inches at the right of the needle bar. The machine pulley has a 6¾ inch diameter belt groove. Maximum length of stitch 2½ to the inch. Presser foot lift ⅞ inch.

MACHINE 144w304 is a long-arm machine with working space of 30 inches at the right of the needle bar and is used for stitching on automobile door panels and for similar large work. Otherwise the machine is the same as Machine 144w204.

SPEED

The maximum speed recommended for these machines is 1500 revolutions per minute, when permitted by the nature of the material being sewn. The machines should be run slower than the maximum speed until the parts which are in movable contact have become glazed by their action on each other. When the machines are in operation, the machine pulley should turn over toward the operator.

NEEDLES

Needles for Machines of Class 144w are of Class and Variety 7x3, made in sizes 21, 22, 23, 24, 25, 26 and 27, for cloth and 7x19 made in sizes 22, 23, 24, 25 and 27 for stitching cardboard and fibre door panels.

The size of the needle to be used should be determined by the size of the thread, which must pass freely through the eye of the needle. If rough or uneven thread is used, or if it passes with difficulty through the eye of the needle, the successful use of the machine will be interfered with.

Orders for needles must specify the quantity required, the size number, also the class and variety numbers separated by the letter X.

The following is an example of an intelligible order:

"100 No. 24, 7x3 Needles."

The best results will be obtained when using the needles sold by The Singer Company.

TO REMOVE THE NEEDLE BAR ROCK FRAME ROCK SHAFT

Remove the face plate and needle bar rock frame, then loosen the clamp screw at (Y, Fig. 19) and draw out the rock shaft and remove the sleeve.

THE FEED ECCENTRIC

The feed eccentric is provided with a gib (B2, Fig. 23) which can be adjusted to take up any wear or loose motion between the feed eccentric and the eccentric body. To adjust the gib, loosen the two locking screws (C2, Fig. 23) nearest the gib, then turn in the two adjusting screws (A2) against the gib until all play is eliminated and the eccentric fits snugly in the slot in the eccentric body. Securely tighten the two locking screws (C2).

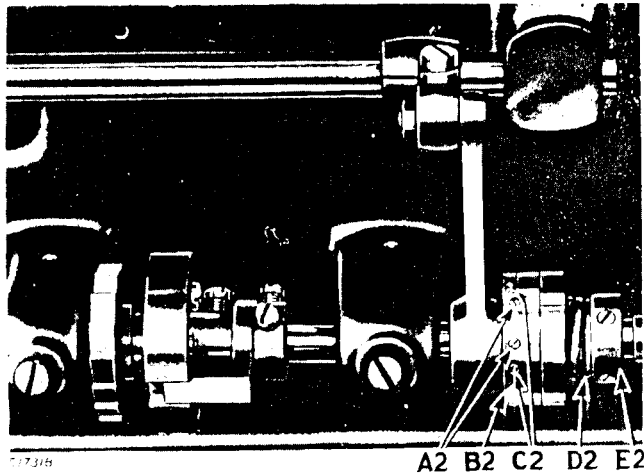

Fig. 23

The spring (D2, Fig. 23) presses against the feed eccentric cam to prevent it from moving out of position while the machine is operating. The collar (E2) should be set flush with the end of the hub of the eccentric body and the set screw in the collar should enter the hole in the hub of the eccentric body.

Loosen the thumb screw in the upper end of the face plate, turn the face plate upward and oil the wick and bearings which are thus uncovered, then turn down the face plate and tighten the thumb screw.

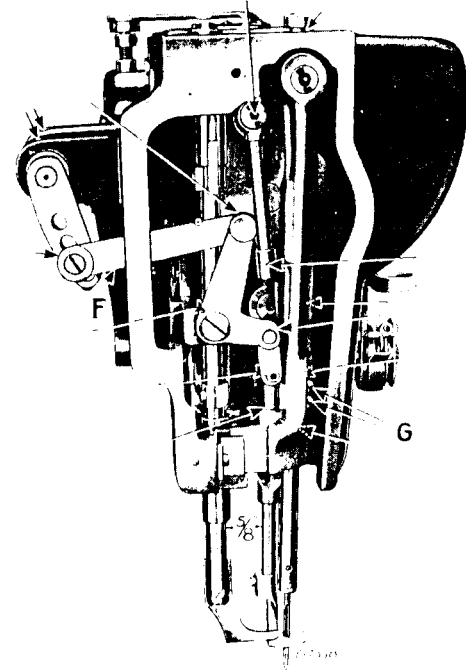

Fig. 4. End View of Machine Showing Oiling Points Also Adjustments on the Machine

Apply a few drops of oil four times daily to the felt pad in the side wall of the bobbin case as illustrated in Fig 10.

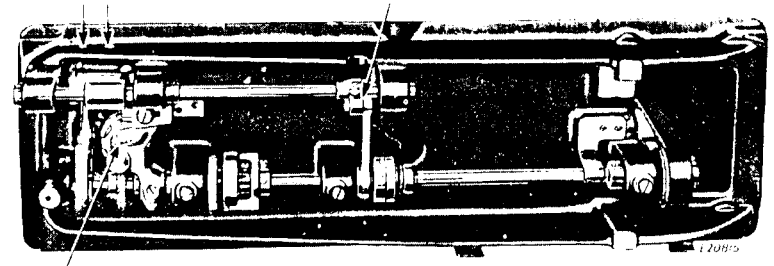

Fig. 5. Base of Machine Showing Oiling Points

TO SET THE SEWING HOOK TO OR FROM THE NEEDLE

To prevent the point of the hook from dividing the strands of the thread, it should run as close to the needle (within the scarf) as possible.

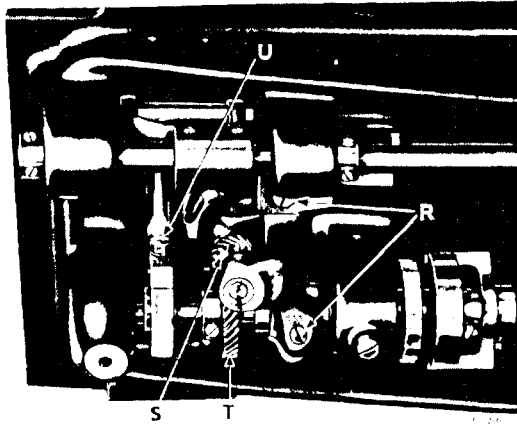

Fig. 20. Adjustment of Hook Saddle

Turn the machine pulley over toward you until the point of the sewing hook is at the center of the needle. Loosen the two screws (R, Fig. 20) holding the hook saddle underneath the bed of the machine and move the hook saddle to the right or left, as may be required, until the point of the hook is as close to the needle as possible without striking it, then securely tighten the two screws (R).

The needle guard (Y, Fig. 22), which is attached to the side of the sewing hook, should be sprung until it prevents the needle from striking the hook in case the needle is deflected towards the hook.

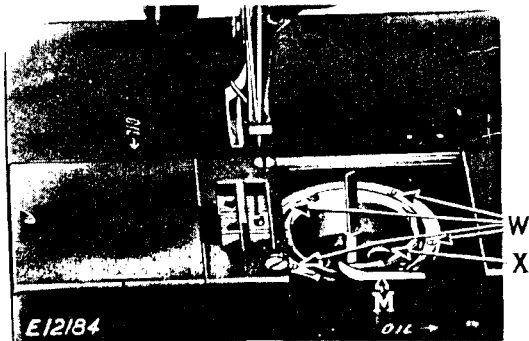

Fig. 21. Removing Bobbin Case

TO WIND THE BOBBIN ON MACHINE 144w204

(See Fig. 8)

Fasten the bobbin winder to the table with its driving pulley in front of the machine belt, so that the pulley will drop away from the belt when sufficient thread has been wound upon the bobbin.

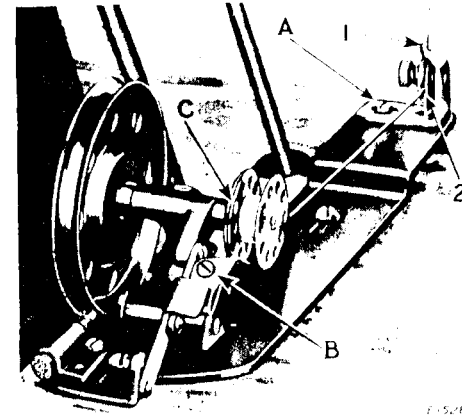

Fig. 8. Winding the Bobbin

Place the bobbin on the bobbin winder spindle and push it on as far as it will go, being sure that stud (C) enters a hole in the bobbin.

Pass the thread down through the thread guide (1) in the tension bracket, around the back and between the tension discs (2). Then wind the end of the thread around the bobbin a few times, push the bobbin winder pulley over against the machine belt and start the machine.

When sufficient thread has been wound upon the bobbin, the bobbin winder will stop automatically.

If the thread does not wind evenly on the bobbin, loosen the screw (A) in the tension bracket and move the bracket to the right or left as may be required, then tighten the screw.

The amount of thread wound on the bobbin is regulated by the screw (B). To wind more thread on the bobbin, turn the screw (B) inwardly. To wind less thread on the bobbin, turn the screw outwardly.

Bobbins can be wound while the machine is stitching.

TO SET THE NEEDLE BAR

See that the needle is up in the bar as far as it will go. There are two lines across the needle bar about two inches above the lower end. When the needle bar is at its lowest position, the upper mark should be just visible at the end of the needle bar frame.

In case the needle bar is not correctly set, loosen the needle bar connecting stud pinch screws at (G, Fig. 4) and place the needle bar in correct position as directed above, then retighten the screws (G).

TO SET A NEEDLE BAR WHICH HAS NO MARK

Adjust the feeding mechanism as instructed on page 13 so that there is no feed movement of the needle bar, then set the needle bar so that when it rises $\frac{1}{8}$ inch from its lowest position, the point of the sewing hook will be about $1\frac{1}{16}$ inch above the eye of the needle.

TO ADJUST FEED DOG

The feed dog should be set so that the needle is centered in the needle hole. In case the needle does not enter the hole in the feed dog correctly, loosen the pinch screw (L2, Fig. 26) and adjust the feed dog as required, then securely tighten the pinch screw (L2).

RELATIVE POSITIONS OF VIBRATING PRESSER BAR AND LIFTING PRESSER BAR

The distance between the vibrating presser bar and lifting presser bar, after adjusting the feed mechanism so that there is no feed movement of the needle bar, should be $\frac{3}{8}$ inch as shown in Fig. 4.

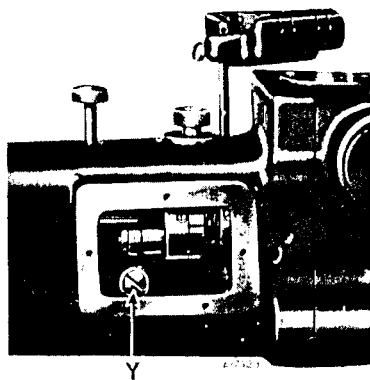

Fig. 19

TO REPLACE THE BOBBIN AND THREAD THE BOBBIN CASE

Hold the bobbin between the thumb and forefinger of the right hand, the thread drawing on the bottom from left to right as shown in Fig. 10, and

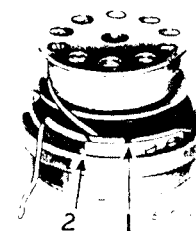

Fig. 10. Direction of Thread on Bobbin

place it on the center stud of the bobbin case, then push down the latch (L, Fig. 11). Draw the thread into the slot (1, Fig. 10), under the tension spring and into slot (2) as shown in Figs. 10 and 11, leaving a loose end of thread about two inches long above the slide. When closing the slide plate, leave just enough space for the thread to pass through.

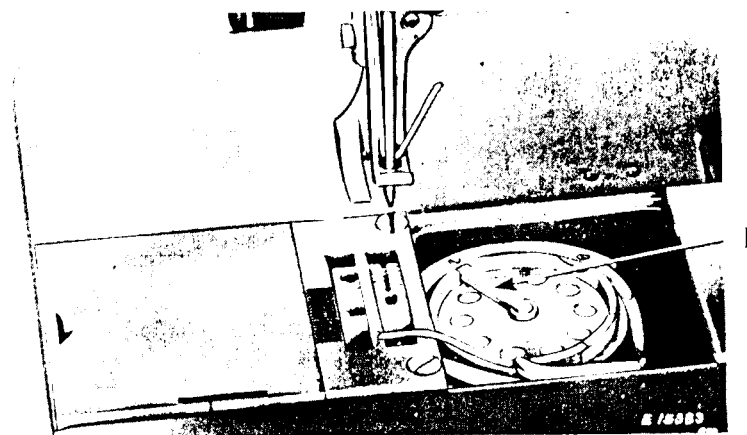

Fig. 11. Bobbin Case Threaded

TENSIONS

The needle and bobbin threads should be locked in the center of the thickness of the material, thus:



Fig. 15. Perfect Stitch

If the tension on the needle thread is too tight, or if that on the bobbin thread is too loose, the needle thread will lie straight along the upper surface of the material, thus:



Fig. 16. Tight Needle Thread Tension

If the tension on the bobbin thread is too tight, or if that on the needle thread is too loose, the bobbin thread will lie straight along the under side of the material, thus:



Fig. 17. Loose Needle Thread Tension

TO REGULATE THE TENSIONS

The tension on the needle thread is regulated by the thumb nut (Q, Fig. 18) at the front of the tension discs on the front of the machine. To increase the tension, turn this thumb nut over to the right. To decrease the tension, turn this thumb nut over to the left.

The tension on the bobbin thread is regulated by means of the screw nearest the center of the tension spring on the outside of the bobbin case. To increase the tension, turn this screw over to the right. To decrease the tension, turn this screw over to the left.

TO REGULATE THE PRESSURE ON MATERIAL

To increase the pressure of the presser feet on the material, turn the thumb screw (H, Fig. 14), at the back of the machine, downward. To decrease the pressure, turn this thumb screw upward.

The pressure on the material should be sufficient to enable the feed to move the work along evenly.

TO RAISE OR LOWER THE PRESSER FEET

The presser feet are raised by pressure on the foot treadle and may be locked in the raised position by moving the lever (D, Fig. 2) all the way to the left. A slight pressure on the treadle will automatically release the locking device.

TO PREPARE FOR SEWING

With the left hand hold the end of the needle thread, leaving it slack from the hand to the needle. Turn the machine pulley over toward you

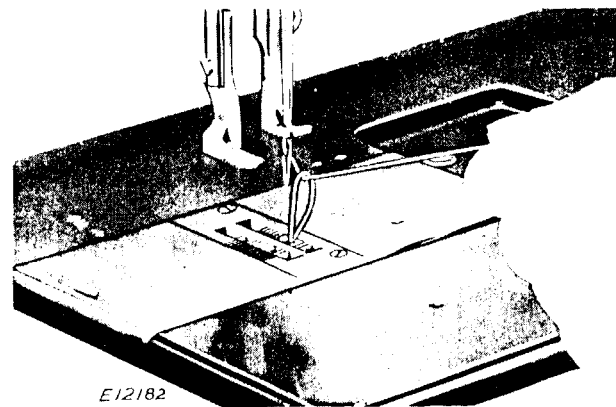

Fig. 13. Pulling Up the Bobbin Thread

until the needle moves down and up again to its highest point, thus catching the bobbin thread; draw up the needle thread and the bobbin thread will come up with it through the hole in the feed dog. Lay the threads back under the presser feet and close the slide.

TO COMMENCE SEWING

Place the material beneath the presser feet, lower the presser feet and commence to sew, turning the machine pulley over toward you.

TO REMOVE THE WORK

Have the thread take-up lever at the highest point, raise the presser feet, draw the work back and cut the threads close to the goods. Lay the ends of the threads back under the presser feet.

TO REGULATE THE LENGTH OF STITCH

To change the length of stitch, two adjustments are necessary—one for the forward and backward movements of the needle and one for the travel of the feed dog. THESE ADJUSTMENTS MUST BE MADE AT THE SAME TIME.

The forward and backward movements of the needle are regulated by means of the knurled plunger (J, Fig. 14) in the arm. The travel of the feed dog is regulated by means of the right hand button (K, Fig. 14) in the bed.

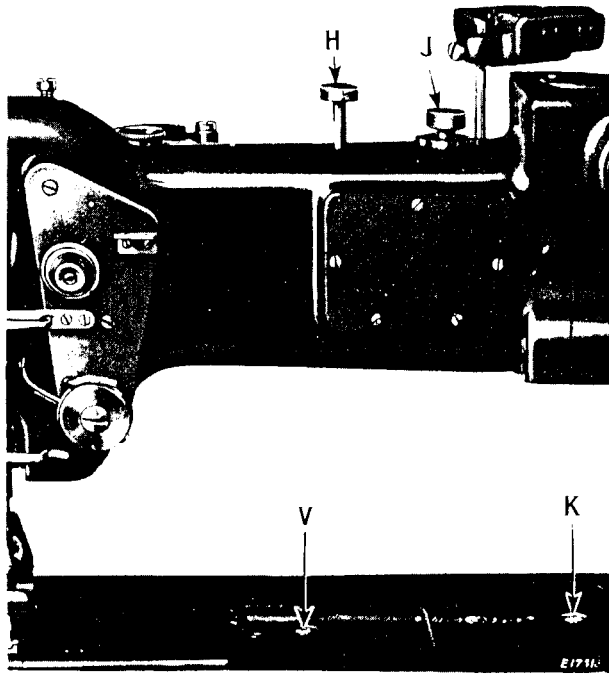

Fig. 14. Adjustments for Changing Length of Stitch

The plunger (J, Fig. 14) and the button (K, Fig. 14) must both be FULLY DEPRESSED when changing the length of stitch. NEVER TURN THE MACHINE PULLEY WHEN ONE OF THESE PLUNGERS IS DEPRESSED WHILE THE OTHER IS OUT, FOR, TO DO SO WOULD CHANGE THE TIMING BETWEEN THE NEEDLE AND THE FEED DOG.

To change the length of stitch, press in the knurled plunger (J) and at the same time slowly turn the machine pulley toward you by hand until the plunger (J) enters the adjustable eccentric on the arm shaft, then turn the plunger $\frac{1}{4}$ turn to the right or left to lock it in position.

Now, depress and continue to hold down the button (K) in the bed, making certain that it has entered the notch in the feed driving eccentric. A very slight movement of the machine pulley forward or backward may be necessary to allow the button to drop into the notch. The stitch length can now be changed by turning the machine pulley over toward you to increase the stitch length or away from you to shorten the stitch. When the desired stitch length adjustment has been made, release the button (K) in the bed and before starting the machine, turn the plunger (J) in the arm until it springs outwardly, thus releasing the adjustable eccentric in the arm.

When the foregoing instructions have been followed and it is desired to change the stitch length again, it may occur that, after locking the plunger (J) in the arm, the button (K) cannot be pressed directly into the notch in the feed driving eccentric, depending on the direction in which the machine pulley was turned to make the previous adjustment. To overcome this difficulty, lock the plunger (J) in the arm first, then while pressing the button (K) in the bed, turn the machine pulley backward and forward until the button (K) drops into the notch.

CAUTION

NEVER change the forward and backward movements of the needle without also changing the travel of the feed dog.

BEFORE OPERATING THE MACHINE, the plungers (J) and (K) must be disengaged from the eccentrics in the arm and bed.

THREADING THE NEEDLE

(See Fig. 12)

Pass the thread from the unwinder through one of the holes (1) in the thread oiler, and under the wire guide (2) (which may be raised by prying

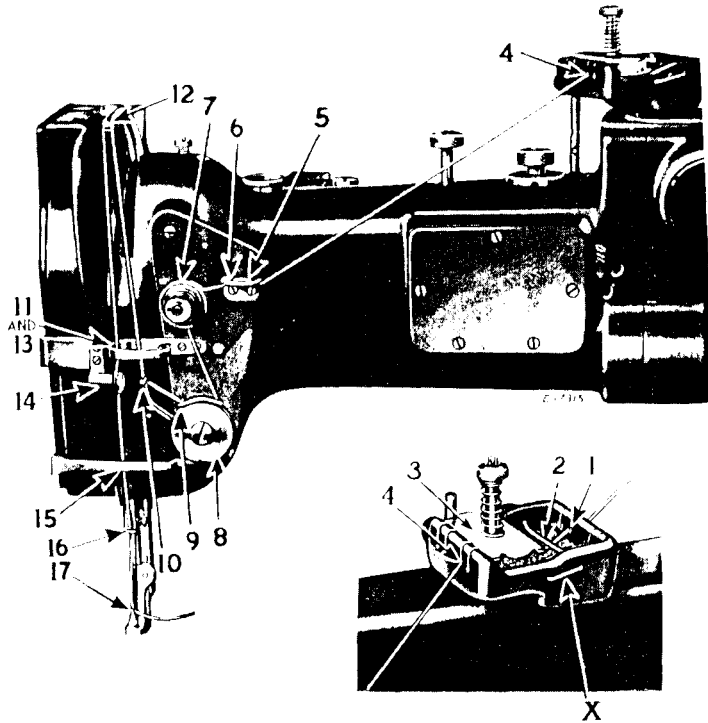

Fig. 12

the end (X) out of its position hole with a screwdriver and turning it to the right), then under the oil pad (3) and out through one of the notches (4) in the thread oiler; downward to the thread guide, up through the eyelet (5), down through the eyelet (6), over between the tension discs (7), down around the thread controller (8) and into the thread controller thread guide (9), into the thread take-up spring (10), up through the guide (11), from right to left through the hole (12) in the take-up lever, down through the guide (13), into the thread guide (14) (used only for thread smaller than No. 12), back of the lower guide (15), into the self-threading needle bar thread guide (16) and from left to right through the eye (17) of the needle.

INSTRUCTIONS

FOR

ADJUSTERS AND MECHANICS

THREAD CONTROLLER

The thread controller spring should be set so that it reaches its lowest point as the eye of the needle nearly reaches the goods in its descent.

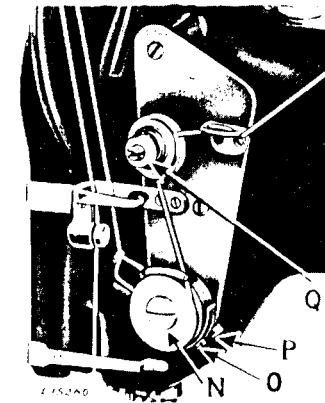

Fig. 18. Adjustment of Thread Controller

For more controller action on the thread, loosen the stop screw (O, Fig. 18) at the right of the controller and set the stop lower, and for less action set the stop higher.

To strengthen the action of the controller spring on the thread, loosen the spring stud screw (P, Fig. 18) at the rear of the stop screw and turn the spring stud (N, Fig. 18) slightly to the left with a screwdriver, or to lighten its action turn to the right and retighten the spring stud screw.

TO WIND THE BOBBIN ON MACHINE 144w304

(See Fig. 9)

Place the bobbin on the bobbin winder spindle and push it up against the shoulder until it is in line with the bobbin winder latch.

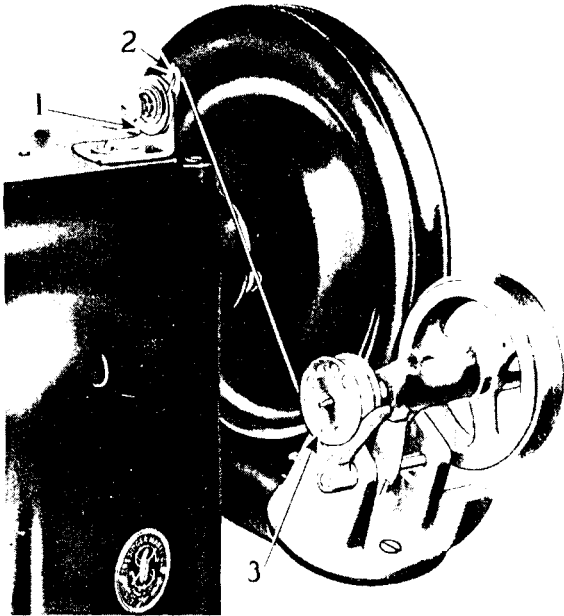

Fig. 9. Winding the Bobbin

Pass the thread from the unwinder, under and between the tension discs (1), through the eyelet (2), and wind the end of the thread around bobbin (3) a few times. Push the bobbin winder pulley against the machine pulley and press the latch against the bobbin. When sufficient thread has been wound on the bobbin, the bobbin winder will stop automatically. Bobbins can be wound while the machine is stitching.

If the distance between the vibrating presser bar and the lifting presser bar is more or less than $\frac{3}{8}$ inch, see that the feeding mechanism is set so that there is no feeding movement of the needle bar, then remove the cover at the front of the machine, loosen the clamp screw (Y, Fig. 19) which holds the needle bar rock frame rock shaft and move the needle bar frame forward or backward to the required distance. A piece of metal of the correct width may be used to determine the correct distance. When the adjustment has been made, securely tighten the clamp screw (Y), replace the cover plate and restore the feeding mechanism to its original position.

TO CHANGE THE AMOUNT OF LIFT OF THE ALTERNATING PRESSERS

The height of lift of the pressers is adjustable by moving the link (f, Fig. 4) to any of the four holes in the rock shaft crank. The maximum lift is secured with the link in the bottom hole. The amount of lift should be regulated according to the thickness of the material being sewn. The feet should lift just high enough to clear the material.

TO ADJUST THE RELATIVE HEIGHT OF LIFT OF THE VIBRATING AND LIFTING PRESSERS

As a rule, the vibrating and lifting pressers should lift an equal height, but some grades of work may require that they lift an unequal height. To change the relative lift of the presser feet, loosen the screw (E, Fig. 3) at the back of the machine and move the vibrating presser bar upward or downward as required, then securely tighten the screw (E).

TO TIME THE SEWING HOOK

Set the feed mechanism so that there is no feeding motion.

Remove the throat plate and turn the machine pulley over toward you until the lower mark across the needle bar is just visible at the end of the needle bar frame on the upward stroke of the needle bar. If the needle bar and sewing hook are correctly timed, the point of the hook will be at the center of the needle and about $\frac{1}{16}$ inch above the eye.

In case the sewing hook is not correctly timed, turn the machine pulley over toward you until the needle bar has descended to its lowest point and has risen until the lower timing mark across the needle bar is just visible at the end of the needle bar frame.

Loosen the two screws in the hub of the hook driving gear (T, Fig. 20) and tap this gear to the right or left on the hook driving shaft until the point of the hook is at the center of the needle. Tapping to the right gives an earlier hook timing, and to the left a later hook timing. Securely tighten the two set screws in the gear (T).

THREAD

Use left twist thread for the needle. Either left or right twist thread may be used for the bobbin.

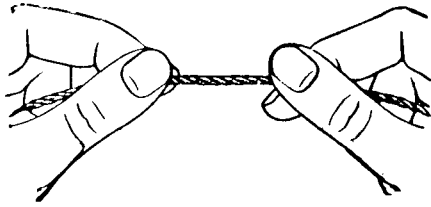

Fig. 6. How to Determine the Twist

Hold the thread as shown above. Turn the thread over toward you between the thumb and forefinger of the right hand; if left twist, the strands will wind tighter; if right twist, the strands will unwind.

TO SET THE NEEDLE

Turn the machine pulley over toward you until the needle bar moves up to its highest point; loosen the set screw in the needle bar and put the needle up into the bar as far as it will go, with its long groove toward the left, the eye of the needle being directly in line with the machine bed, then tighten the set screw.

TO REMOVE THE BOBBIN

Draw back the slide plate in the bed of the machine and turn the machine pulley until the bobbin case opener (M, Fig. 7) moves clear of the bobbin. With the forefinger or a screwdriver, raise the latch (L) to a vertical position and lift out the bobbin.

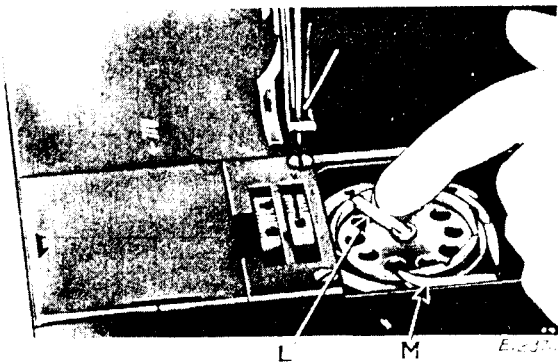

Fig. 7. Removing the Bobbin

TO REMOVE THE BOBBIN CASE FROM THE SEWING HOOK

Remove the bobbin case opener (M, Fig. 21); remove the four hook gib screws (W, Fig. 21) from the sewing hook, lift off the hook gib (Z, Fig. 22) and remove the bobbin case (X, Fig. 21).

TO REMOVE THE SEWING HOOK FROM THE MACHINE

Remove the throat plate, feed dog and the bobbin case opener. Loosen the two screws in the hook shaft gear (S, Fig. 20) and lift out the sewing hook.

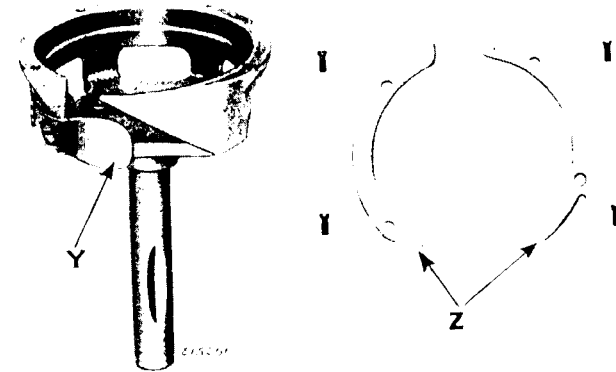

Fig. 22. Sewing Hook Removed from Machine Showing Hook Gib and Needle Guard

TO RAISE OR LOWER THE FEED DOG

Usually when the feed dog is at its highest position, it should show a full tooth above the throat plate.

Remove the throat plate; clean the lint and dust from between the feed points and replace the throat plate; tip the machine back and turn the machine pulley towards you until the feed dog is at its highest position; loosen screw (U, Fig. 20) in the feed lifting cam fork on the feed bar and raise or lower the feed dog, as may be required, and retighten the screw (U).

When raising or lowering the feed dog, be careful that its underside does not drop low enough to strike the sewing hook.

OILING THE MACHINE

When the machines are received from the factory, they should be thoroughly cleaned and oiled. When in continuous use, they should be oiled at least twice a day.

Use "TYPE B" or "TYPE D" OIL, sold by The Singer Company.

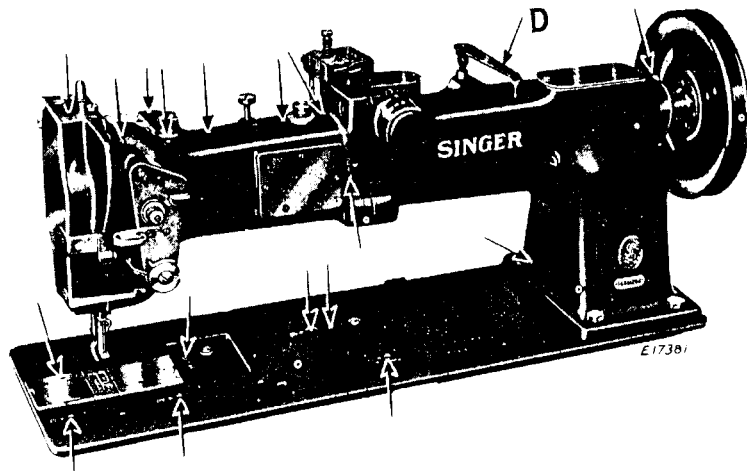
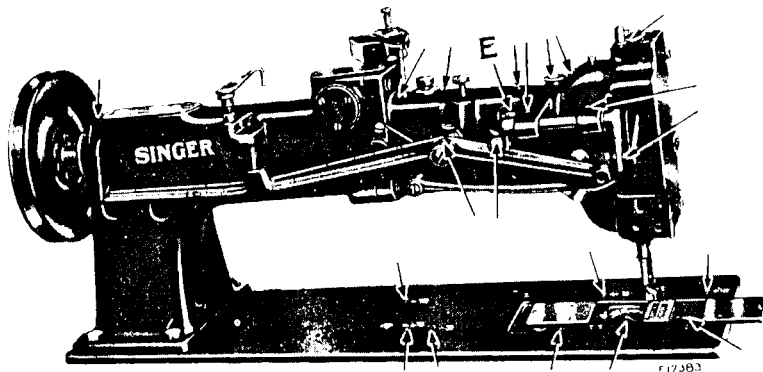

Fig. 2. Front View of Machine 144w204
Showing Oiling Points

Oil should be applied at each of the places designated by arrows in Figs. 2, 3, 4, 5, 10 and 27.



TO REMOVE THE ARM SHAFT CONNECTION BELT FROM WITHIN THE ARM

Slide the connection belt off the lower belt pulley; remove the machine pulley; loosen the three screws in the arm shaft bushing near the machine pulley and remove the bushing; lift the belt up through the arm cap hole as far as possible and draw it out through the space normally occupied by the bushing.

Owing to the fact that the sewing hook makes two revolutions to one revolution of the hook driving shaft, and that the feed lifting eccentric is on the hook driving shaft, it is possible to have the sewing hook correctly timed without having the feed correctly timed. To overcome this, the plate (F2, Fig. 24) is attached to the underside of the bed of the machine. This plate is marked with an arrow at its lower end and directly alongside of the plate is the collar (G2, Fig. 24) mounted on the hook shaft, which is also marked with an arrow. After replacing the belt over the upper pulley, replace the arm shaft bushing and securely fasten it in position by its three screws; replace the machine pulley. With the belt on the upper pulley, turn the machine pulley from you until the thread take-up lever is at its highest point. Then turn the hook shaft with the fingers until the two arrows, one on the plate (F2) and the other on the collar (G2), are directly in line. Now, without disturbing either the arm shaft or the hook shaft, slip the belt over the lower pulley. The feed will then be correctly timed with the needle bar.

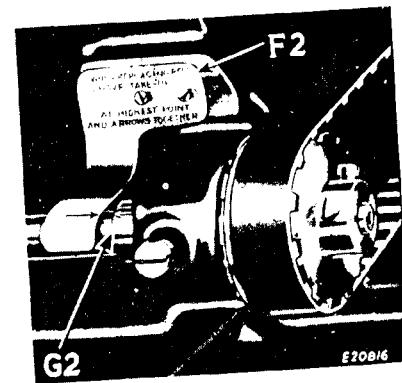

Fig. 24. Timing Plate and Timing Collar

CAUTION: DO NOT PINCH BELT in handling, as this will put a permanent kink in the wire reinforcements. Do not store near radiator or other hot place; preferably in a cool, dark place until belt is installed in machine.

TO ADJUST HAND-WHEEL SHAFT ON MACHINE 144w304

The hand-wheel shaft bushing (F1, Fig. 27) is eccentric and may be rotated to bring the hand-wheel gear (G1, Fig. 27) into proper engagement

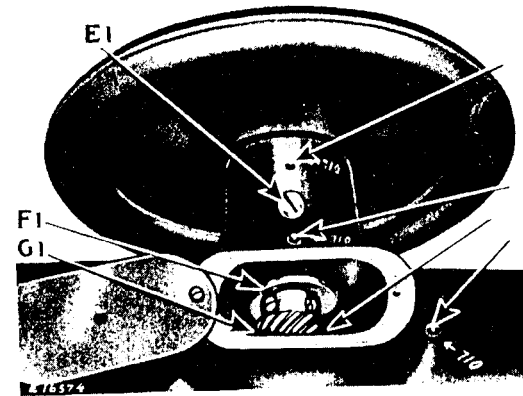
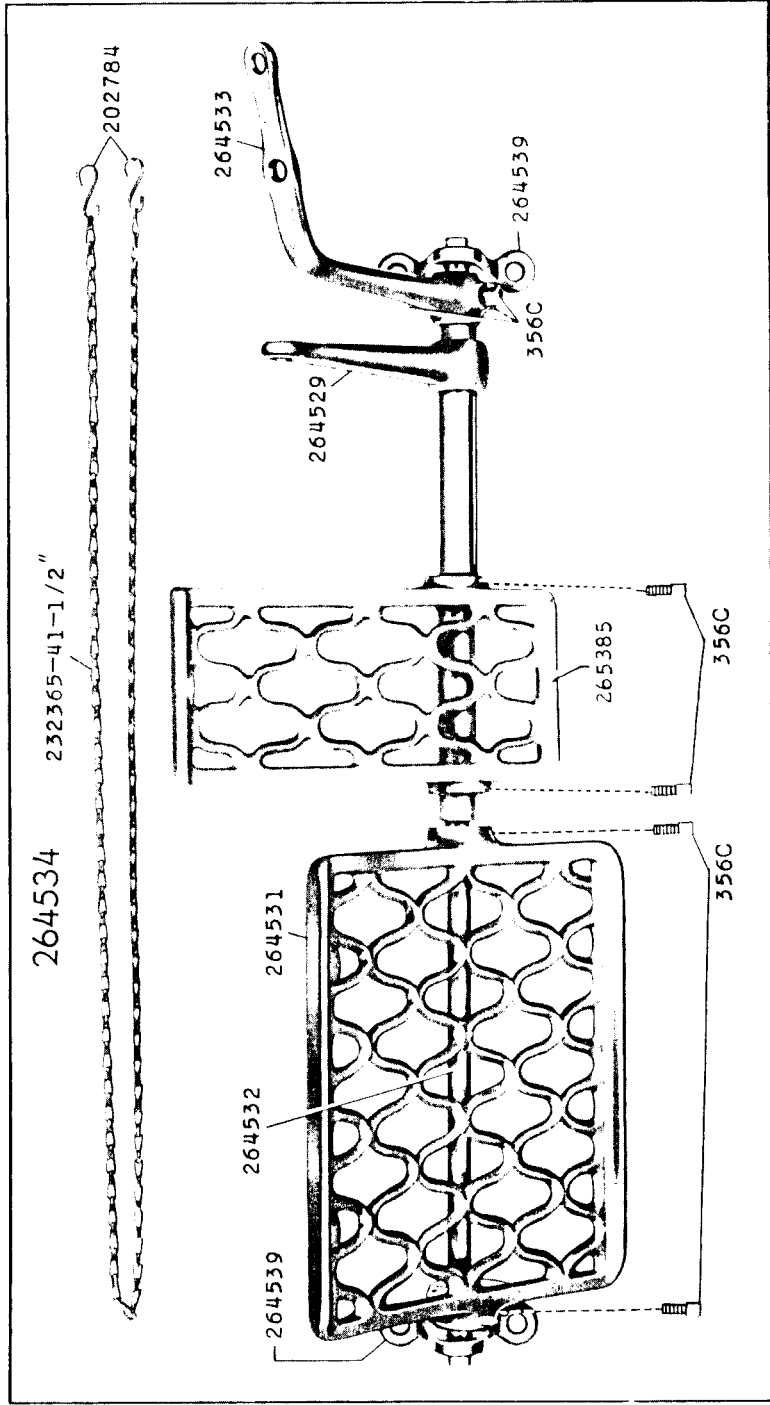
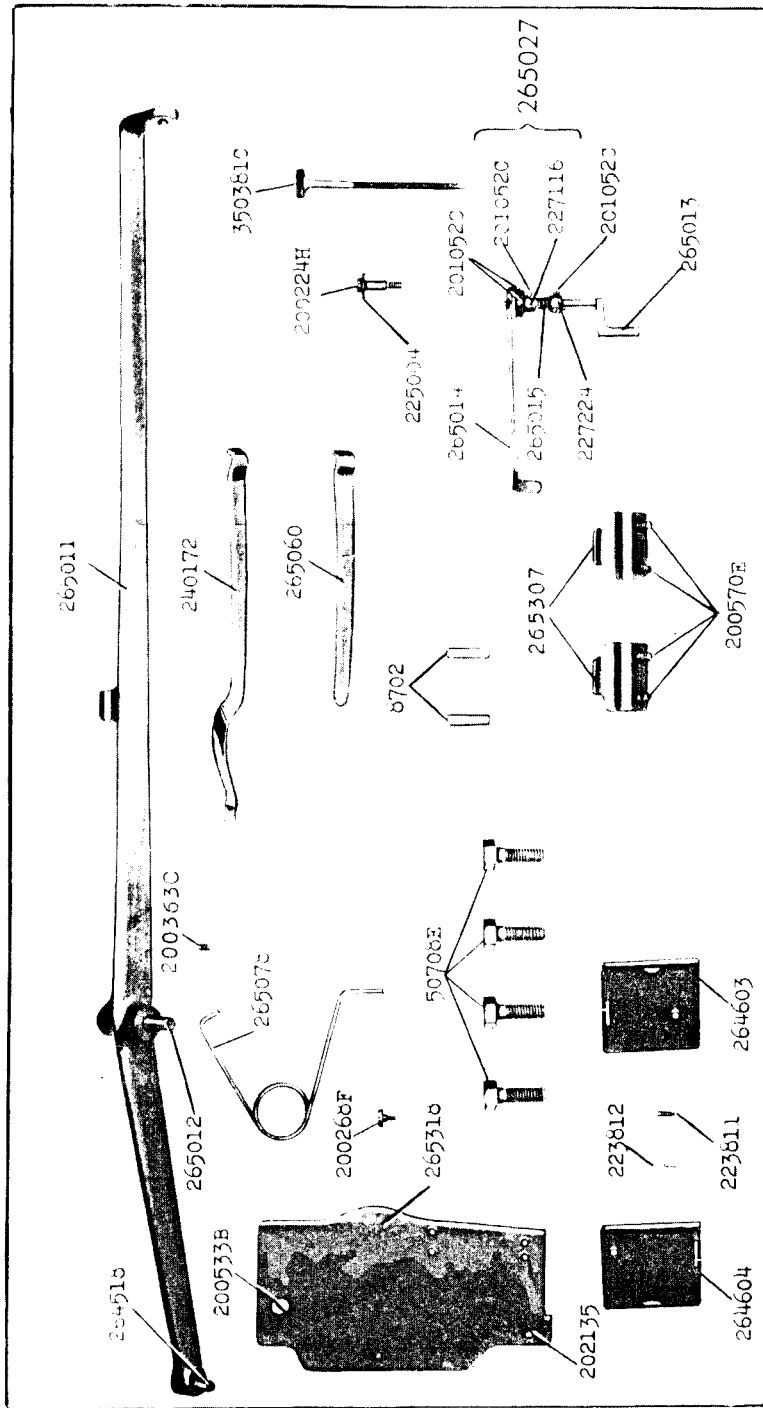

Fig. 27. Rear View, Showing Adjustments and Oiling Points
at Top of Long-Arm Machine

with the gear on the arm shaft. Loosen the bushing set screw (E1, Fig. 27) and the bushing (F1) may then be tapped around by means of a screwdriver in holes in inner end of bushing until there is only a trace of backlash between the gears. Then tighten the set screw (E1).



16146 - 1/5



18515

236963

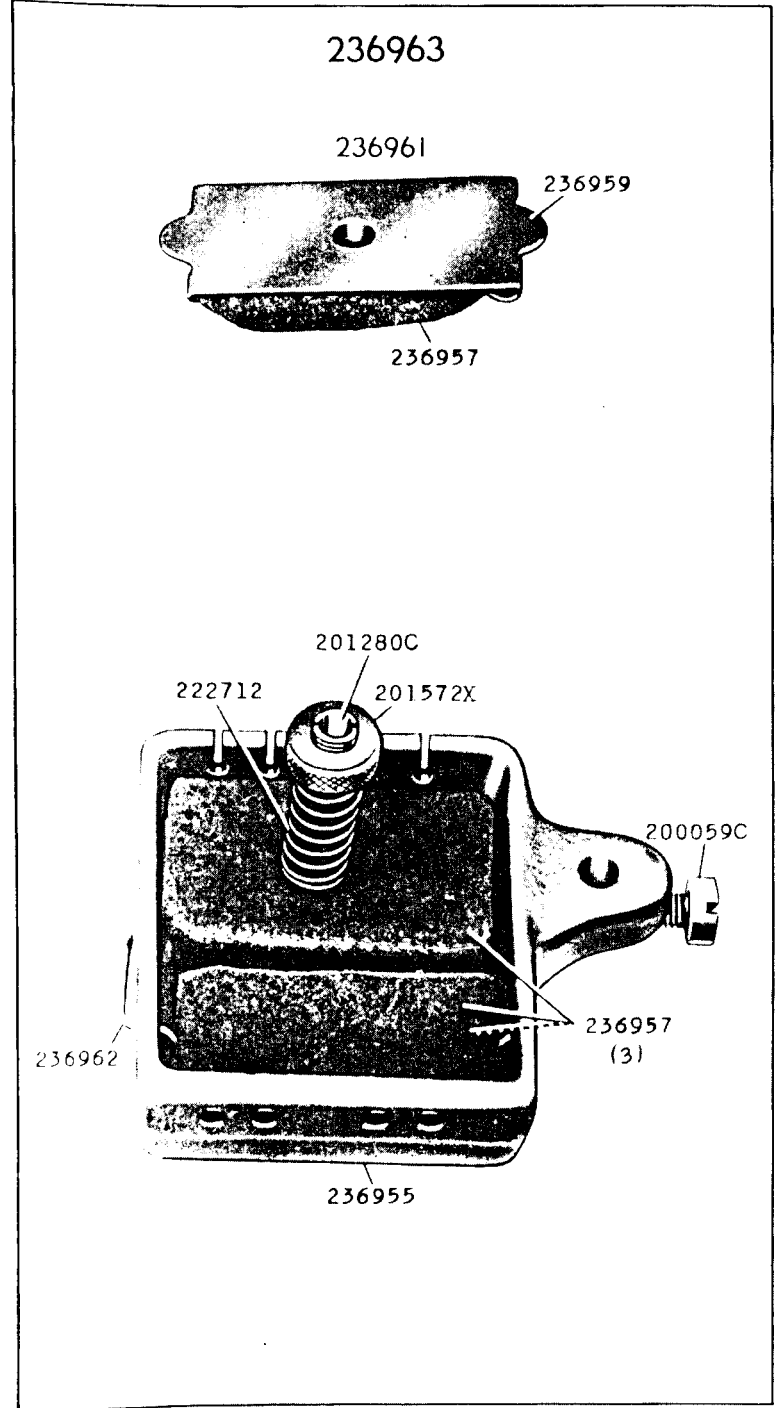

16148 - 1/6

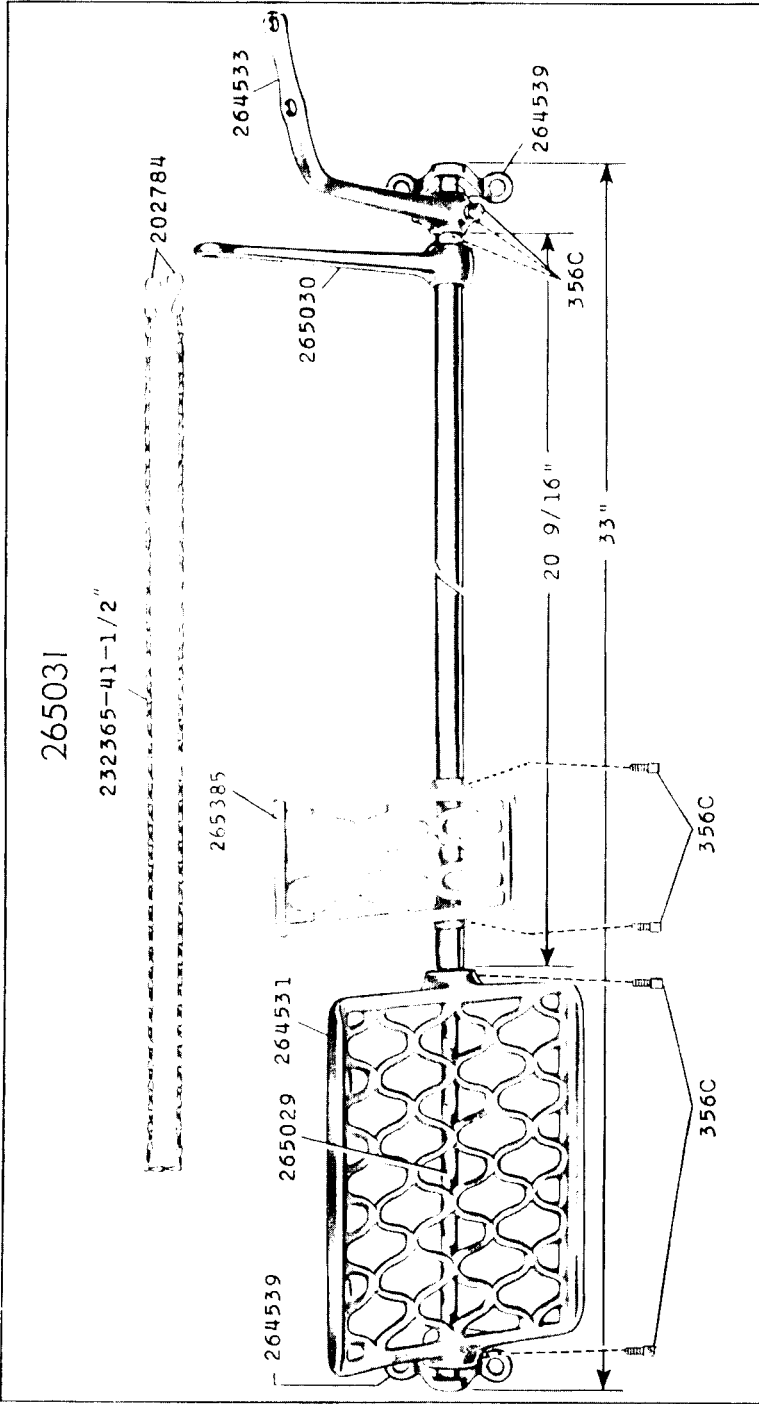

18512 - 1/4

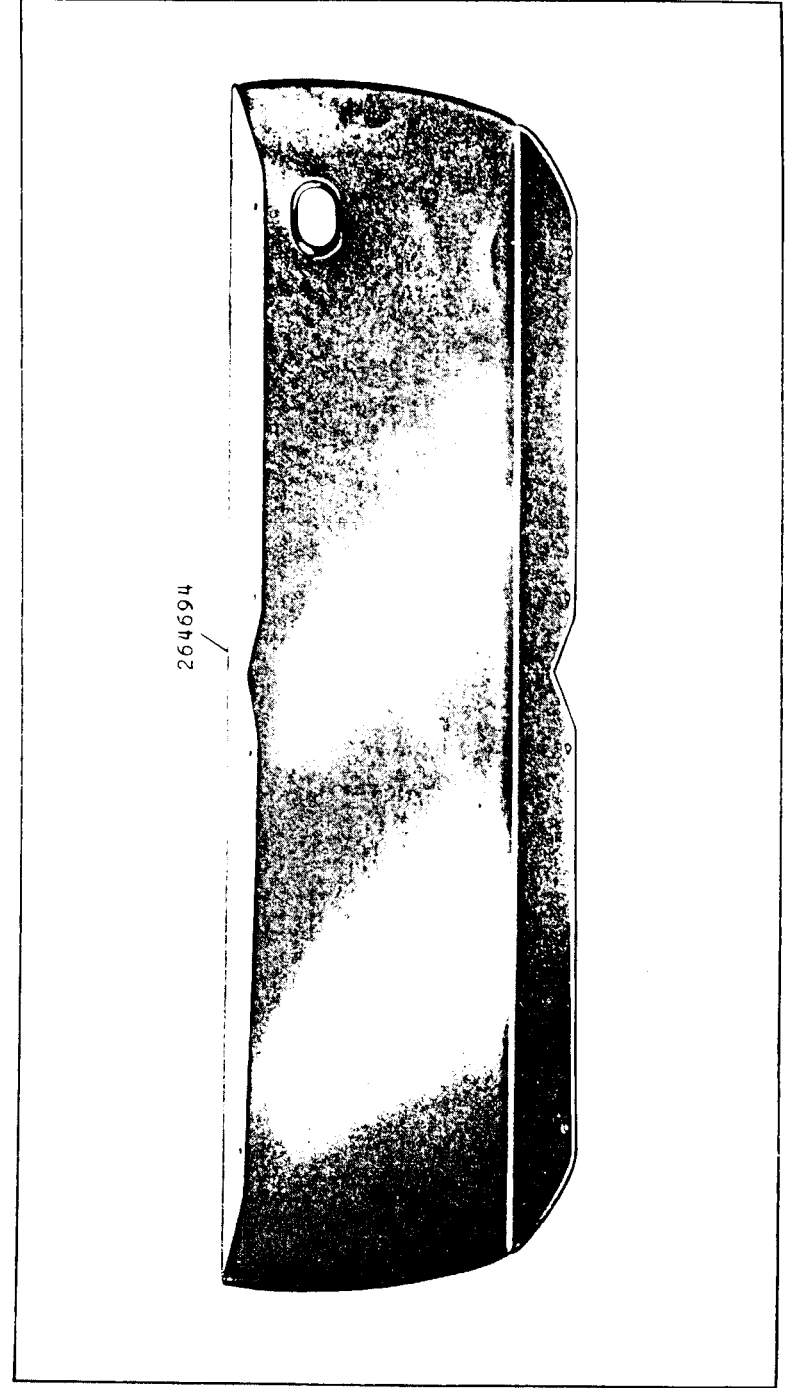

16169 - 5/8

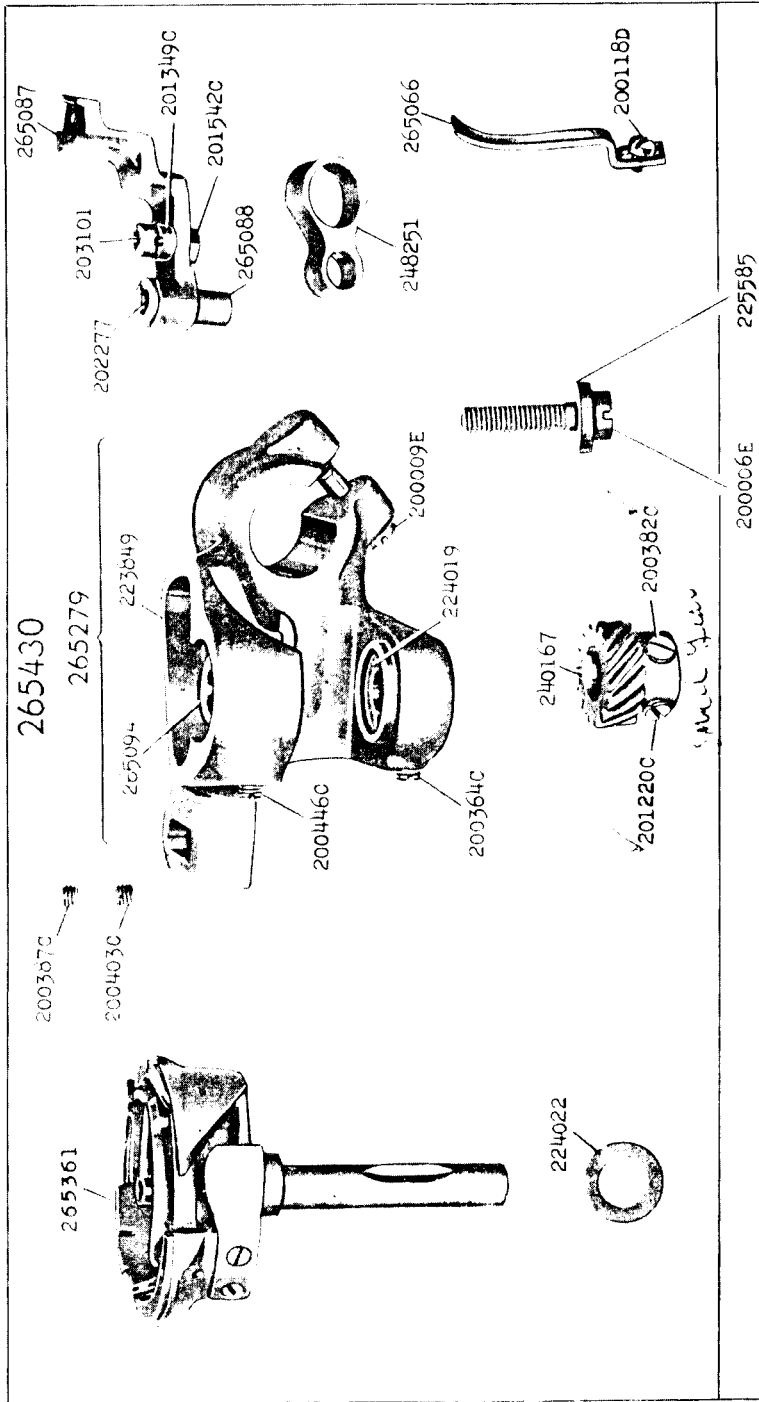

18509 - 3/8

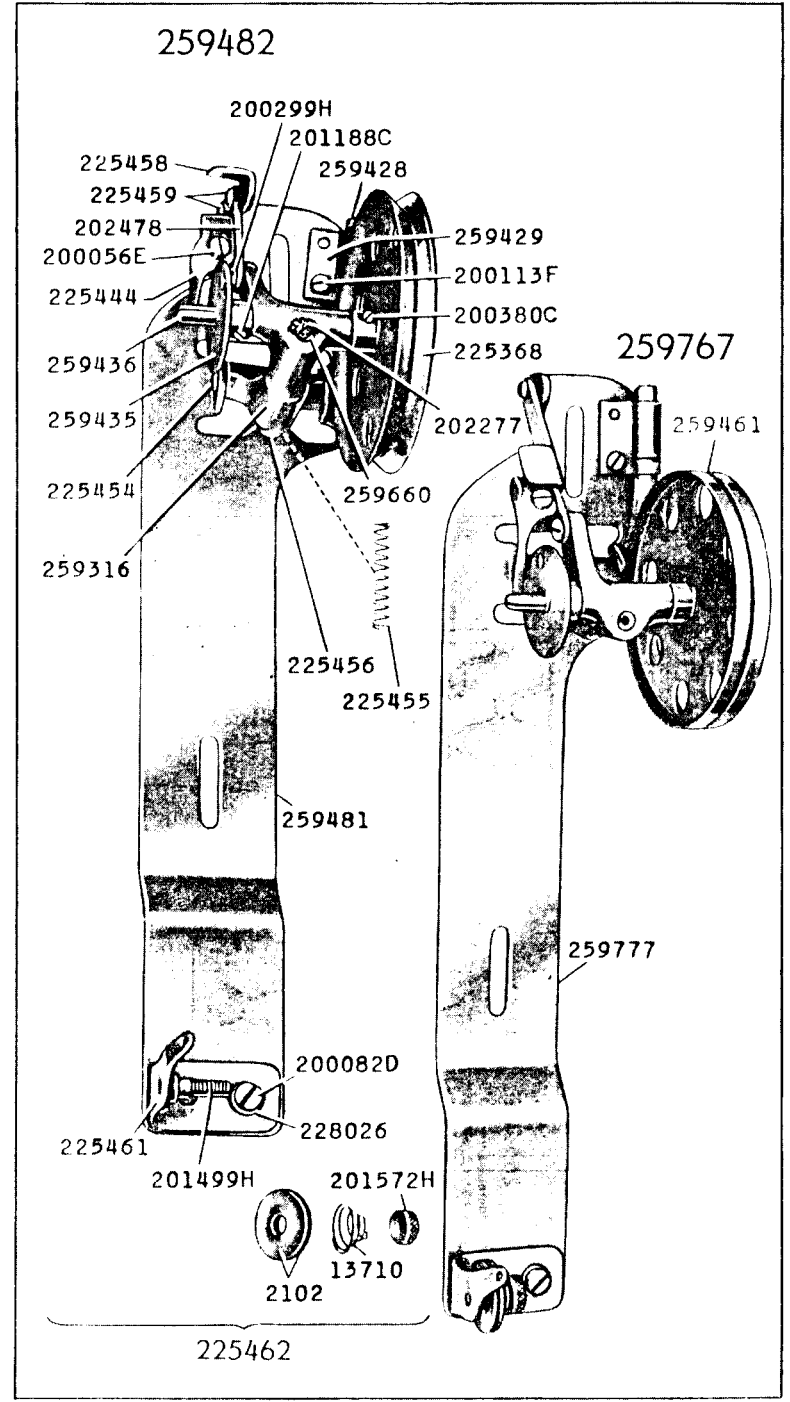

16172 - 5/8

960 (43)

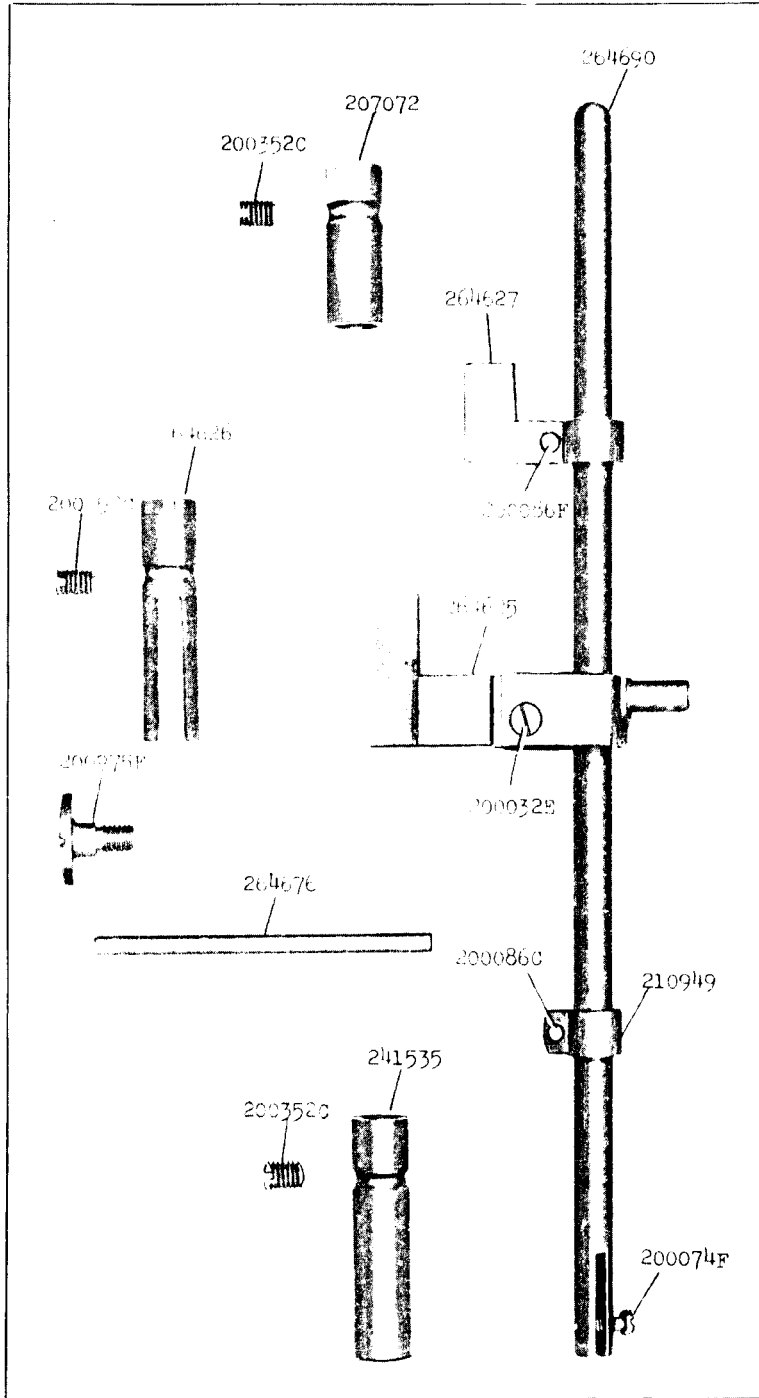

18504 5/8

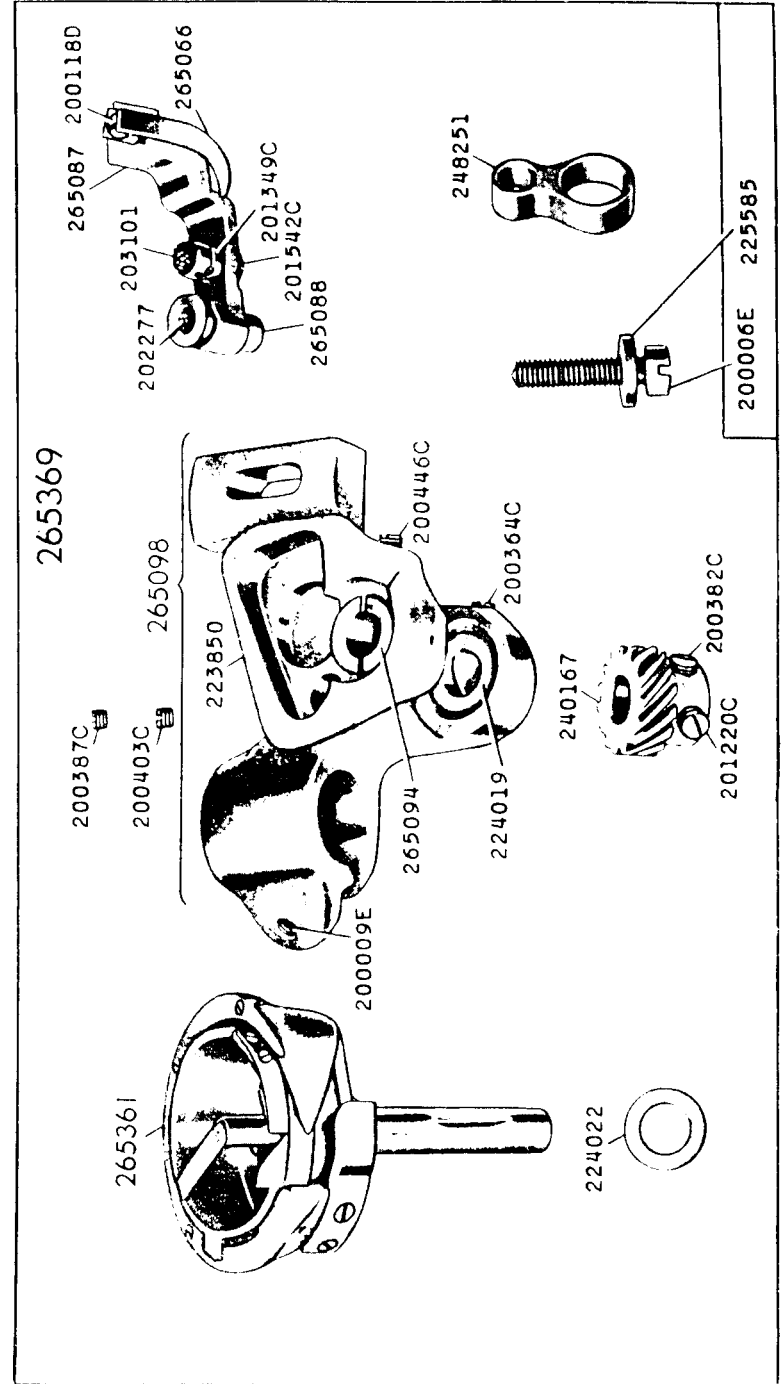

16184 - 1/2

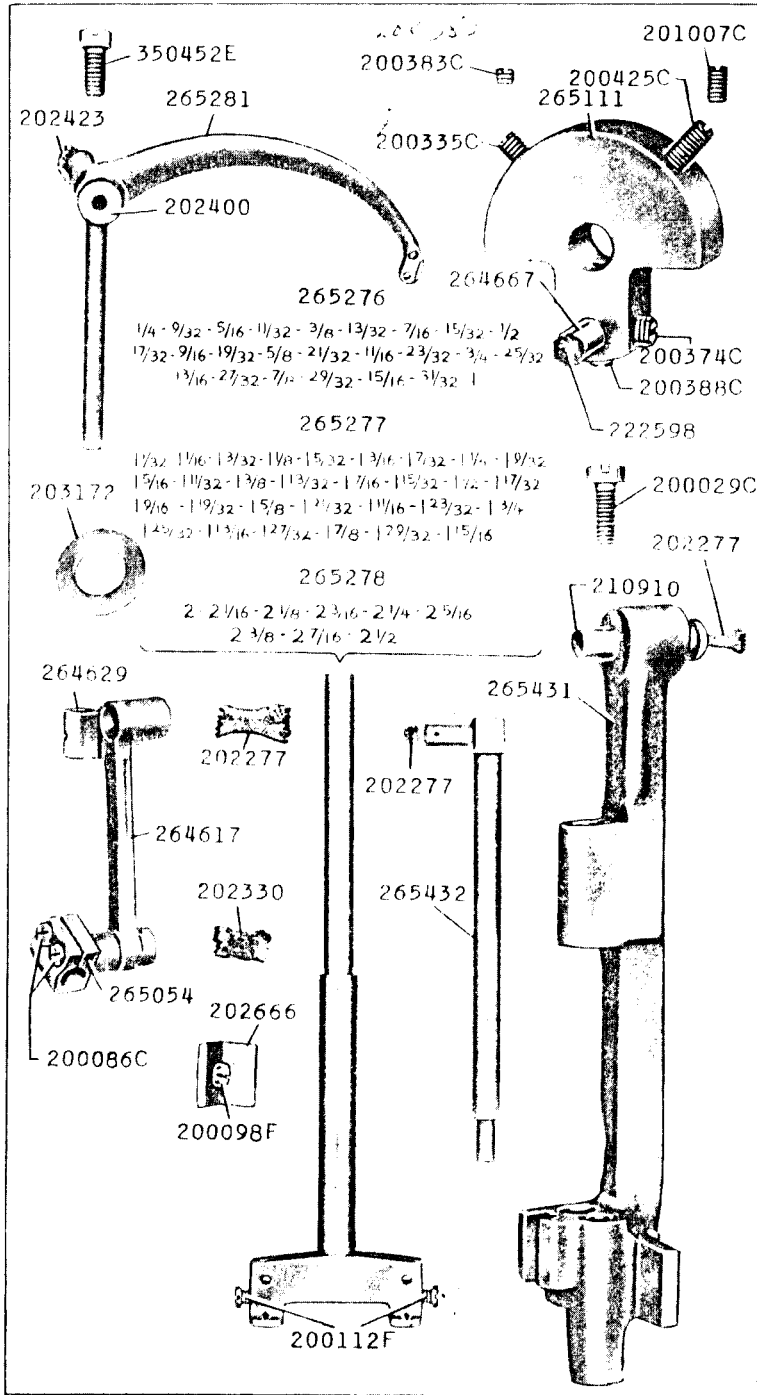

16185 - 3/8

