

**SINGER**  
**175-1 to 175-22**

CHART SHOWING CLASS 75 OSANN MACHINES  
SUPERSEDED BY  
CLASS 175 SINGER MACHINES

LIST OF PARTS  
FOR  
UNION BUTTON SEWERS  
Nos. 175-1 to 175-22

<u>Osann Class and Variety</u>		<u>Singer Class and Variety</u>
75-1-1	Superseded by	175-1
75-3-3	" "	175-2
75-7-2	" "	175-3
75-2-1	" "	175-4
75-2-3	" "	175-5
75-2-4	" "	175-6
75-2-6	" "	175-7
75-2-2	" "	175-8
75-2-5	" "	175-9
75-4-4	" "	175-10
75-4-5	" "	175-11
75-4-6	" "	175-12
75-4-7	" "	175-13
75-4-8	" "	175-14
75-5-1	" "	175-15
75-5-3	" "	175-16
75-5-4	" "	175-17
75-5-5	" "	175-18
75-8-1	" "	175-19
75-8-2	" "	175-20
75-9-1	" "	175-21
		175-22

# INSTRUCTIONS FOR ORDERING

In ordering from this list, use ONLY the part NUMBER in the FIRST or SECOND column.

If a "U" number (first column) has been assigned a Singer No. (second column) the Singer No. must be ordered.

The number stamped on a Sewing Machine Part is in every case the number of the single part only.

Every combination of parts sent out as such has its specific number, which, although not stamped on the parts, must be used when ordering the combination.

Each number always indicates the SAME PART in whatever list it appears, or for whatever machine.

The letters after some of the numbers indicate the style of finish only, as follows:

- A-Hardened, Polished, Nickel Plated and Buffed
- B-Polished, Nickel Plated and Buffed
- C-Hardened Only
- D-Polished Only
- E-Soft, Not Polished
- F-Hardened and Polished
- F.J-Hardened, Polished and Nickel Plated
- G-Bright Rumbled and Nickel Plated
- H-Blued
- J-Nickel Plated Only
- K-Hardened and Nickel Plated
- L-Brass Plated
- M-Oxidized
- N-Japanned, Dull
- P-Japanned, Bright
- R-Merlized
- S-Cadmium Plating
- T-Copper Plated
- T.A-Hardened, Polished, Copper and Nickel Plated and Buffed
- T.B-Copper and Nickel Plated and Polished
- T.J-Copper and Nickel Plated Only
- T.K-Hardened, Copper and Nickel Plated
- T.M-Copper Plated and Oxidized
- T.L-Copper and Brass Plated
- U-Zinc Plated
- V-Silver Plated
- W-Polished and Nickel Plated
- Y-Black Nickel Plated Only
- Z-Chromium Plated
- Z.B-Polished, Nickel Plated, Buffed and Chromium Plated
- Z.J-Nickel and Chromium Plated

These letters MUST BE USED when they appear in the list; and AFTER the number as in the list.

The figures under the heading "PLATES" refer only to the illustrations and are NOT TO BE USED in ordering.

## LIST OF PARTS

FOR

## UNION BUTTON SEWERS

Nos. 175-1 to 175-22

NOTE: FOR LIST PRICES OF "U" NUMBERS HAVING CORRESPONDING SINGER NUMBER, REFER TO FORM E. O. 293.

Osann No.	Singer No.	Plate	Name	Each
U 8000	-----	-----	Arm for 175-1, 175-3 to 175-16, 175-18 and 175-21 Machines.....	\$50.00
U 8001	175009	-----	Arm Side Cover (right) for all Machines except 175-2 Machine.....	
U 8002	175010	U21902	Arm Side Cover (right) Screw Stud (long)...	
U 8003	175011	U21902	" " " " " " (short) for all Machines except 175-2 Machine...	
U 8004	51649E	U21901	Arm Side Cover (right) Screw Stud Lock Nut.	
U 8005	51650B	U21901	" " " " Thumb Nut.....	
U 8008	175171	U21922	Thread Eyelet (back).....	
U 8009	175167	U21922	Tension (automatic) Thread Eyelet.....	
U 8010	175172	U21922	Thread Eyelet (front).....	
U 8011	175061	U21908	Face Plate complete for 175-1, 175-3 to 175-6, 175-8 to 175-16 and 175-21 Machines.....	
U 8012	-----	U21903	Face Plate Screw.....	15
U 8013	175066	U21903	" " Thread Guide (upper).....	
U 8014	202093	U21903	" " " " (lower) Roller.....	
U 8015	175065	U21903	" " " " " " Pin..	
U 8016	175062	U21903	" " " " " " Plate.....	
U 8017	-----	U21903	" " " " " " Screw	15
U 8018	175063	U21903	" " " " " " " " Spacing Collar.....	
U 8019	175043	U21915	Button Clamp Lifting and Thread Pull-off Holder Shaft for 175-1 to 175-6, 175-8 to 175-16 and 175-21 Machines.....	
U 8020	175044	U21907	Button Clamp Lifting and Thread Pull-off Holder Shaft Collar, for all Machines except 175-2 Machine.....	
U 8021	-----	U21907	Button Clamp Lifting and Thread Pull-off Holder Shaft Collar Set Screw, for all Machines except 175-2 Machine.....	15
U 8022	175041	U21904	Button Clamp Lifting Arm.....	
U 8023	-----	U21906	" " " " Set Screw.....	15
U 8025	-----	U21906	" " " " Chain Screw (lower) or (upper).....	15
U 8026	175186	U21920	Thread Pull-off (back).....	

Parts for Union Button Sewers

Osann No.	Singer No.	Plate	Name	Each
U 8027	-----	U21924	Thread Pull-off (back) Set Screw.....\$	15
U 8028	175187	U21924	" " " Holder.....	
U 8029	160C	U21906	" " " Set Screw.....	
U 8030	175188	U21920	" " (front).....	
U 8032	175189	U21924	" " " Holder, for all Ma- chines except 175-2 Machine.....	
U 8033	175191	U21924	Thread Pull-off Stop Collar.....	
U 8036	175045	U21907	Button Clamp Lifting and Thread Pull-off Holder Shaft Spring.....	
U 8037	175046	U21907	Button Clamp Lifting and Thread Pull-off Holder Shaft Spring Collar.....	
U 8039	175047	U21904	Button Clamp Lifting Rod.....	
U 8040	175477	U21951	Face Plate Thread Nipper Releasing Rod Col- lar for 175-19, 175-20 and 175-22 Ma- chines.....	
U 8042	42830	U21907	Button Clamp Lifting Rod Cotter Pin.....	
U 8043	175048	U21904	" " " " Arm.....	
U 8045	50269C	U21906	" " " " Position Screw	
U 8046	175166	U21922	Tension (automatic) Screw Stud complete....	
U 8047	175160	U21922	" " or (stationary) Disc...	
U 8048	175522	U21922	" " Releasing Disc.....	
U 8049	125314	U21922	" " Spring.....	
U 8050	-----	U21922	" " or (stationary) Regu- lating Thumb Nut.....	15
U 8051	175163	U21920	Tension (automatic) Releasing Rod.....	
U 8052	175164	U21920	" " " " Spring...	
U 8053	1521J	U21901	" " " " Nut.....	
U 8054	175165	U21922	" " " " Wearing Sleeve.....	
U 8055	175169	U21922	Tension (stationary) Screw Stud complete...	
U 8057	13710	U21922	" " Spring.....	
U 8059	175178	U21923	Thread Nipper Releasing Rod complete.....	
U 8060	175174	U21923	" " Plate.....	
U 8062	175175	U21923	" " " Washer.....	
U 8063	-----	U21923	" " Releasing Head Screw.....	25
U 8064	175181	U21923	" " " Rod Spring (upper)..	
U 8065	175182	U21923	" " " " Collar..	
U 8066	-----	U21923	" " " " " "	
			Set Screw.....	15
U 8067	175179	U21923	Thread Nipper Releasing Rod Spring (lower)..	
U 8070	175180	U21923	" " " " " "	
			Washer.....	
U 8071	175176	U21923	Thread Nipper Releasing Lever, for all Ma- chines except 175-2 Machine.....	
U 8072	140046C	U21923	Thread Nipper Releasing Lever Hinge Screw..	
U 8073	175183	U21923	" " " Screw Stud for 175-1 to 175-6, 175-8, 175-10 to 175-16 and 175-21 Machines.....	
U 8074	175184	U21923	Thread Nipper Releasing Screw Stud Nut Washer.....	
U 8075	1722J	U21903	Thread Nipper Releasing Screw Stud Nut.....	
U 8076	200125F	U21917	Needle Set Screw.....	

Parts for Union Button Sewers

Osann No.	Singer No.	Plate	Name	Each
U 8077	204383	U21902	Needle Bar complete for all Machines except 175-10 to 175-14, 175-17 and 175-22 Ma- chines.....\$	
U 8078	204250	U21917	Needle Bar Thread Guide, for all Machines except 175-10 to 175-14 Machines.....	
U 8079	200175D	U21917	Needle Bar Thread Guide Screw, for all Ma- chines except 175-10 to 175-14 Machines.	
U 8080	175629	U21916	Needle Bar Connecting Link Hinge Stud com- plete.....	
U 8082	175101	U21916	Needle Bar Connecting Link Hinge Stud Thread Guide Roller.....	
U 8083	-----	U21916	Needle Bar Connecting Link Hinge Stud Thread Guide Plate Screw.....	15
U 8084	175100	U21916	Needle Bar Connecting Link Hinge Stud Thread Guide Plate.....	
U 8085	175104	U21915	Needle Bar Connecting Stud (upper).....	
Note: Nos. 1681J and 51652J must be included when ordering 175104.				
U 8086	175103	U21916	Needle Bar Connecting Stud (lower) or (up- per) Washer.....	
U 8087	-----	U21916	Needle Bar Connecting Stud (lower) or (up- per) Nut.....	15
U 8088	-----	U21916	Needle Bar Connecting Stud (lower) or (up- per) Nut Lock Nut.....	15
U 8089	175102	U21915	Needle Bar Connecting Stud (lower) for 175-1 to 175-4 Machines.....	
Note: Nos. 1681J and 51652J must be included when ordering 175102.				
U 8093	175098	U21916	Needle Bar Connecting Link for 175-1 to 175-4 Machines.....	
U 8094	140028C	U21916	Needle Bar Connecting Link Hinge Screw.....	
U 8096	175004	U21915	Arm Rock Shaft complete for 175-1 to 175-4 Machines.....	
U 8097	-----	U21919	Needle Bar Vibrating Lever, for all Machines except 175-19 and 175-20 Machines.....	5 00
U 8098	175127	U21918	Needle Bar Vibrating Lever Hinge Screw Slide.....	
U 8099	140034C	U21918	Needle Bar Vibrating Lever Hinge Screw.....	
U 8100	140035C	U21918	" " " " " " Lock Screw.....	
U 8101	175121	U21917	Needle Bar Vibrating Lever Adjusting Brack- et, obsolete, use 175759.....	
U 8102	-----	U21918	Needle Bar Vibrating Lever Adjusting Brack- et Lock Nut Screw Stud.....	50
U 8105	-----	U21918	Needle Bar Vibrating Lever Adjusting Brack- et Lock Nut.....	15
U 8106	175122	U21918	Needle Bar Vibrating Lever Hinge Screw Slide, obsolete, use 175759.....	
U 8107	140032C	U21917	Needle Bar Vibrating Lever Hinge Screw.....	
U 8110	175126	U21919	" " " " Arm.....	
U 8115	140033C	U21922	" " " " Hinge Screw.	
U 8119	-----	U21909	" " " " Cam for 175-1 and 175-13 Machines.....	5 00

## Parts for Union Button Sewers

Osann No.	Singer No.	Plate	Name	Each
U 8120	175071	U21902	Feed Cam Driving Worm Wheel Shaft, for all Machines except 175-10 to 175-14 and 175-21 Machines.....\$	
U 8121	175119	U21917	Needle Bar Vibrating Cam Pin.....	
U 8122	175185	U21923	Thread Nipper Releasing Stud, for all Machines except 175-2, 175-7, 175-9, 175-17 to 175-20 and 175-22 Machines.....	
U 8135	-----	-----	Bed for 175-1, 175-3, 175-4 to 175-12, 175-15, 175-16 and 175-21 Machines.....	50 00
U 8137	-----	U21906	Needle Plate Screw.....	15
U 8140	175305	U21925	Feed Plate for 175-4 to 175-6 Machines.....	
U 8141	-----	U21914	" " Screw for 175-1 to 175-7, 175-9, 175-15 and 175-16 Machines.....	15
U 8142	175073	U21910	Feed Plate Carrier for 175-1, 175-3 to 175-9, 175-15, 175-16 and 175-18 Machines.....	
Note: Two No. 227J must be included when ordering 175073.				
U 8143	175018	U21902	Bed Top Cover (back) for 175-1, 175-3 to 175-9, 175-15 and 175-16 Machines.....	
U 8144	-----	U21906	Bed Top Cover (back) Screw, for all Machines except 175-2, 175-19 and 175-20 Machines.....	15
U 8145	175076	U21910	Feed Plate Carrier Guide Block (right) for 175-1, 175-3 to 175-9, 175-15 to 175-18 and 175-21 Machines.....	
U 8146	175075	U21910	Feed Plate Carrier Guide Block (left) for 175-1, 175-3 to 175-6, 175-8, 175-9, 175-15 to 175-17 and 175-21 Machines.....	
U 8148	175081	U21910	Feed Plate Carrier Regulator complete for all Machines except 175-10 to 175-14, 175-17, 175-21 and 175-22 Machines.....	
U 8149	175078	U21914	Feed Plate Carrier Regulating Nut Screw Stud Slide Block, for all Machines except 175-10 to 175-14, 175-17 and 175-21 Machines.....	
U 8150	175548	U21914	Feed Plate Carrier Regulating Nut Screw Stud, for all Machines except 175-7, 175-17, 175-18 and 175-21 Machines.....	
Note: No. 51667C must be included when ordering 175548.				
U 8151	175079	U21914	Feed Plate Carrier Regulating Nut Screw Stud Washer, for all Machines except 175-2, 175-10 to 175-14, 175-17 and 175-21 Machines.....	
U 8152	51667C	U21914	Feed Plate Carrier Regulating Nut, for all Machines except 175-7, 175-17, 175-18 and 175-21 Machines.....	
Note: No. 175548 must be included when ordering 51667C.				
U 8153	175083	U21914	Feed Plate Carrier Regulator Spring, for all Machines except 175-10 to 175-14, 175-17 and 175-21 Machines.....	
U 8155	175074	U21910	Feed Plate Carrier Driving Arm complete for all Machines except 175-10 to 175-14, 175-17 and 175-21 Machines.....	

## Parts for Union Button Sewers

Osann No.	Singer No.	Plate	Name	Each
U 8156	175069	U21903	Feed Plate Carrier Driving Arm Pin, for all Machines except 175-10 to 175-14, 175-17 and 175-21 Machines.....\$	
U 8160	175067	U21909	Feed Cam, for 175-1 Machine.....	
U 8161	-----	U21903	" " Screw, for all Machines except 175-10 to 175-14, 175-17 and 175-21 Machines.....	15
U 8162	175032	U21906	Feed Cam Screw Washer, for all Machines except 175-10 to 175-14, 175-17 and 175-21 Machines.....	
U 8163	51923	U21903	Feed Plate Carrier Driving Arm Roller and Screw Stud.....	
U 8165	175654	-----	Button Clamp complete for 175-6 Machine....	
Note: Nos. 175042 and 175052 must be included when ordering 175654.				
U 8166	175322	U21927	Button Clamp Arm, for 175-6 Machine.....	
U 8167	175334	U21951	" Stop, for 175-6 Machine.....	
U 8168	175333	U21927	" Clamp Spreader, for 175-6 Machine....	
Note: Nos. 175336, two each 458C, 140063K and four 191J must be included when ordering 175333.				
U 8169	-----	U21951	Button Stop Body Screw, for 175-6 Machine..	15
U 8171	175335	U21951	" " " for 175-6 Machine.....	
Note: Two Nos. 191J, 458C and 140063K must be included when ordering 175335.				
U 8175	175332	U21951	Button Clamp Opening Handle, for 175-6 Machine.....	
U 8177	175315	U21951	Button Clamp (right) for 175-6 Machine....	
Note: No. 140059C must be included when ordering 175315.				
U 8178	175319	U21951	Button Clamp (right) Top Spring, for 175-6 Machine.....	
U 8179	175310	U21951	Button Clamp (left) for 175-6 Machine.....	
Note: No. 140059C must be included when ordering 175310.				
U 8180	175314	U21951	Button Clamp (left) Top Spring, for 175-6 Machine.....	
U 8181	-----	U21951	Button Clamp (left) or (right) Top Spring Screw, for 175-6 Machine.....	15
U 8182	175318	U21951	Button Clamp (right) Side Spring, for 175-6 Machine.....	
U 8183	175313	U21951	Button Clamp (left) Side Spring, for 175-6 Machine.....	
U 8185	-----	U21951	Button Clamp (left) or (right) Position Screw, for 175-6 Machine.....	25
U 8186	140057K	U21951	Button Clamp (left) or (right) Hinge Screw, for 175-6 Machine.....	
U 8188	175317	U21927	Button Clamp (right) Holder, for 175-6 Machine.....	
Note: Two Nos. 228J, 14 0021C and 140061J must be included when ordering 175317.				
U 8189	175312	U21927	Button Clamp (left) Holder, for 175-6 Machine.....	
Note: Nos. 228J, 236J and 140021C must be included when ordering 175312.				

Osann No.	Singer No.	Plate	Name	Each
U 8190	140058C	U21951	Button Clamp (left) or (right) Holder Hinge Screw, for 175-6 Machine.....\$	
U 8193	175330	U21927	Button Clamp Lifting Handle, for 175-6 Machine.....	
U 8194	175329	U21951	Button Clamp Lifting Handle Screw Spacing Collar, for 175-6 Machine.....	
U 8196	175326	U21927	Button Clamp Closing Spring, for 175-6 Machine.....	
U 8197	140060W	U21951	Button Clamp Adjusting Thumb Screw, for 175-6 Machine.....	
U 8198	67425	U21951	Button Clamp Adjusting Thumb Screw Lock Washer, for 175-6 Machine.....	
U 8199	51660J	U21951	Button Clamp Adjusting Thumb Screw Lock Nut for 175-6 Machine.....	
U 8200	175320	U21951	Button Clamp Adjusting Thumb Screw Block, for 175-6 Machine.....	
U 8202	175321	U21950	Button Clamp Adjusting Thumb Screw Plate, for 175-6 Machine.....	
U 8204	175327	U21950	Button Clamp Closing Spring Support, for 175-6 Machine.....	
U 8206	690J	U21950	Button Clamp Closing Spring Support Screw, for 175-6 Machine.....	
U 8207	175328	U21950	Button Clamp Closing Spring Support Plate, for 175-6 Machine.....	
U 8209	175033	U21905	Button Clamp Arm for 175-1, 175-3 to 175-5, 175-8, 175-9, 175-15 and 175-16 Machines	
Note: No. 190J must be included when ordering 175033.				
U 8209A	175325	U21927	Button Clamp Arm Hinge Bracket, for 175-6 Machine.....	
Note: Two No. 191J must be included when ordering 175325.				
U 8210	-----	U21906	Button Clamp Spreader and Button Stop Base Screw.....	15
U 8212	175339	U21940	Button Clamp Presser Bar, for 175-6 Machine	
U 8213	175055	U21904	" " " " Spring.....	
U 8214	140023W	U21903	" " Pressure Regulating Thumb Screw	
U 8216	175054	U21903	" " Presser Bar Screw Bearing, for all Machines except 175-19 to 175-21 Machines.....	
U 8217	175053	U21907	Button Clamp Presser Bar Collar, for all Machines except 175-19 and 175-20 Machines.....	
U 8219	175331	U21950	Button Clamp Presser Bar Contact Block, for 175-6 Machine.....	
Note: No. 190K must be included when ordering 175331.				
U 8220	140062C	U21950	Button Clamp Presser Bar Contact Block Screw, for 175-6 Machine, No. cancelled order 140039.....	
U 8222	175042	U21904	Button Clamp Lifting Chain, 4-1/4 in. long, for all Machines except 175-10 to 175-14 175-19 and 175-20 Machines.....	
U 8224	175035	U21905	Button Clamp Arm Hinge Pin Bracket, for all Machines except 175-19 and 175-20 Machines.....	

Osann No.	Singer No.	Plate	Name	Each
U 8226	175036	U21905	Button Clamp Arm Hinge Pin Bracket Shim (.003 in. thick) for all Machines except 175-19 and 175-20 Machines.....\$	
U 8227	175037	-----	Button Clamp Arm Hinge Pin Bracket Shim (.005 in. thick) for all Machines except 175-19 and 175-20 Machines.....	
U 8228	175038	-----	Button Clamp Arm Hinge Pin Bracket Shim (.007 in. thick) for all Machines except 175-19 and 175-20 Machines.....	
U 8229	175039	-----	Button Clamp Arm Hinge Pin Bracket Shim (.015 in. thick) for all Machines except 175-19 and 175-20 Machines.....	
U 8230	175034	U21905	Button Clamp Arm Hinge Pin.....	
U 8231	140027C	U21914	Looper Shaft Crank Set Screw.....	
U 8232	175124	U21917	Needle Bar Vibrating Lever Adjusting Bracket Lock Nut Screw Stud Set Screw Locking Disc.....	
U 8236	175195	U21929	Hand Wheel, for turning machine by hand....	
U 8237	-----	U21928	" " Set Screw.....	15
U 8245	175162	U21922	Tension (automatic) Releasing Cam.....	
U 8247	175198	U21929	Wrench for 140027.....	
U 8248	175105	U21910	Needle Bar Eccentric.....	
U 8250	175106	U21919	" " " Connecting Rod.....	
U 8253	-----	U21916	" " " " Hinge Screw.....	75
U 8257	175005	U21901	Arm Rock Shaft Crank (back).....	
Note: Nos. 51653J and 140031C must be included when ordering 175005.				
U 8258	-----	U21901	Arm Rock Shaft Crank (back) Clamping Screw.	15
U 8259	140016E	U21901	" " " " " Position Screw.	
U 8260	175068	U21909	Feed Cam Driving Worm, for 175-1 and 175-13 Machines.....	
U 8262	175294	U21909	Feed Cam Driving Worm, for 175-2 to 175-4, 175-8, 175-10 to 175-12, 175-14 and 175-16 Machines.....	
U 8263	175307	U21911	Feed Cam Driving Worm, for 175-5 and 175-6 Machines.....	
U 8265	175070	U21909	Feed Cam Driving Worm Wheel, for 175-1 and 175-13 Machines.....	
Note: Two No. 127J must be included when ordering 175070.				
U 8267	175295	U21909	Feed Cam Driving Worm Wheel, for 175-3 to 175-8, 175-10 to 175-12 and 175-14 to 175-16 Machines.....	
Note: Two No. 127J must be included when ordering 175295.				
U 8268	175308	U21911	Feed Cam Driving Worm Wheel, for 175-5 and 175-6 Machines.....	
Note: Two No. 127J must be included when ordering 175308.				
U 8269	140026C	U21903	Feed Cam Driving Worm Wheel Set Screw.....	
U 8272	175229	U21921	Stop Motion Trip Point.....	
U 8273	175197	U21929	Wrench for 140026.....	
U 8275	175525	U21910	Looper Driving Shaft Crank complete.....	
U 8278	435C	U21914	" " " " Set Screw.....	

## Parts for Union Button Sewers

Osann No.	Singer No.	Plate	Name	Each
U 8280	175089	U21914	Looper Driving Shaft Crank Connecting Link..\$	
U 8282	175085	U21914	Looper.....	
U 8284	175093	U21910	" Shaft.....	
U 8285	175526	U21910	Looper Shaft Crank complete.....	
U 8292	175086	U21910	" Driving Shaft.....	
U 8292B	175092	U21914	" " " Gear Pin.....	
U 8311	175020	U21935	Bed Top Cover (front) for all Machines except 175-2 and 175-16 Machines.....	
U 8342	175155	U21920	Stop Motion Shaft.....	
U 8346	175148	U21919	Starting Crank.....	
U 8346A	175149	U21921	" " Pin.....	
U 8399	175200	U21931	Machine Base complete.....	
U 8403	175115	U21930	Machine Lock Flate complete.....	
U 8404	175207	U21930	" " Thumb Nut Spring.....	
U 8405	175536	U21930	" " " Washer.....	
U 8406	51656J	U21930	" " " Nut.....	
U 8407	175193	U21929	Button Tray, for all Machines except 175-17 and 175-19 to 175-52 Machines.....	
U 8409	175225	U21931	Table Belt Guide Pulley Shaft Bracket.....	
U 8410	-----	-----	1 in. No. 14 R.H. wood screw.....	
U 8411	175224	U21931	Table Belt Guide Pulley Shaft complete.....	
U 8412	175222	U21931	" " " Pulley.....	
U 8413L.H	175220	U21931	" " " (left).....	
U 8413R.H	175221	U21931	" " " (right).....	
U 8415	175219	U21931	Treadle complete.....	
U 8416	175215	-----	Foot Lifter and Starting Lever Chain, 57 in. long.....	
U 8418	51183E	U21914	Looper Driving Shaft Bushing Clamping Screw	
U 8420	175052	U21904	Button Clamp Presser Bar, for all Machines except 175-10 to 175-14, 175-19 and 175-20 Machines.....	
U 8424	140047C	U21930	Machine Locating Screw Stud.....	
U 8425	175150	U21920	Stop Dog.....	
U 8427	175151	U21921	" " Cushion Spring.....	
U 8428	140040C	U21921	" " " Set Screw.....	
U 8429	175152	U21920	" " " Holder.....	
U 8430	50581C	U21921	" " " Set Screw....	
U 8431	175158	U21920	" Motion Trip.....	
U 8434	175159	U21920	" " " Block, for all Machines except 175-2 Machine.....	
U 8434A	175154	U21921	Stop Motion Retaining Collar Screw Stud....	
U 8434B	-----	U21921	" " " " " " " " Set Screw.....	15
U 8435	175113	U21917	Stop Motion Trip Block Spring.....	
U 8436	140042C	U21918	" " " " Hinge Screw.....	
U 8437	175153	U21921	" " Retaining Collar.....	
U 8439	175156	U21920	" " Shaft Spring.....	
U 8440	175157	U21920	" " " Collar.....	
U 8441	140041C	U21921	" " " Set Screw....	
U 8442	175140	U21919	Pulley, 2-3/4 in. diam.....	
U 8443	175051	U21907	Button Clamp Lifting Rod Spring Stop Collar	
U 8445	140037C	U21921	Pulley Engaging Screw.....	

## Parts for Union Button Sewers

Osann No.	Singer No.	Plate	Name	Each
U 8446	51655J	U21921	Pulley Engaging Screw Nut.....\$	
U 8447	175141	U21921	" Oil Pad (wick).....	
U 8448	175145	U21921	" Shifter.....	
U 8449	1179E	U21921	" " Screw.....	
U 8450	175146	U21919	" " Holder.....	
U 8451	-----	U21921	" " " Set Screw.....	15
U 8454	175110	U21917	Needle Bar Eccentric Pawl Bracket.....	
U 8455	134E	U21917	" " " " " Screw.....	
U 8456	175112	U21917	" " " " Hinge Pin.....	
U 8458	175049	U21907	Button Clamp Lifting Rod Arm Stop Plate....	
U 8461	175050	U21904	" " " " Spring.....	
U 8462	175208	U21930	Machine Starting Lever.....	
U 8463	175209	U21930	" " " Spring.....	
U 8464	140048C	U21930	" " " Hinge Screw.....	
U 8465	-----	U21930	" " " Stop Screw.....	15
U 8466	-----	U21930	" " " " " Nut.....	15
U 8467	175051	U21902	Bed End Cover (bottom).....	
U 8469	175016	U21901	" " " Spring.....	
U 8473	175057	U21904	Button Clamp Spreader and Button Stop Base, for 175-1 to 175-5, 175-7 to 175-9, 175-15 and 175-16 Machines.....	
Note: Two No. 140020C must be included when ordering 175057.				
U 8474	175209	U21924	Button Clamp (left) or (right) Spring Reinforcing Spring, for 175-4, 175-5, 175-7 to 175-9, 175-15, 175-16 and 175-18 Machines.....	
U 8476	175056	U21904	Button Clamp Spreader and Button Stop, for 175-1 to 175-3 Machines.....	
Note: Nos. 197J, 140025W, 175058 and two 1472J must be included when ordering 175056.				
U 8477	175302	U21904	Button Clamp Spreader and Button Stop, for 175-4, 175-5, 175-7 to 175-9, 175-15 and 175-16 Machines.....	
Note: Nos. 197J, 140025W, 175058 and two 1472J must be included when ordering 175302.				
U 8478	175058	U21903	Button Clamp Spreader Handle, for 175-1, 175-3 to 175-5, 175-7 to 175-9, 175-15 and 175-16 Machines.....	
U 8479	-----	U21903	Button Clamp Spreader Handle Screw, for 175-1 to 175-5, 175-7 to 175-9, 175-15 and 175-16 Machines.....	15
U 8480	-----	U21906	Button Clamp Spreader and Button Stop Screw for 175-1 to 175-5, 175-7 to 175-9, 175-15 and 175-16 Machines.....	15
U 8482	175028	U21905	Button Clamp (right) for 175-1 and 175-3 Machines.....	
U 8483	175022	U21905	Button Clamp (left) for 175-1 and 175-3 Machines.....	
U 8484	175040	U21907	Button Clamp Closing Spring, for 175-1 to 175-3 Machines.....	
U 8485	175303	U21907	Button Clamp Closing Spring, for 175-4, 175-5 175-7 to 175-9, 175-15, 175-16 and 175-18 Machines.....	

## Parts for Union Button Sewers

Osann No.	Singer No.	Plate	Name	Each
U 8486	-----	U21906	Button Clamp (left) or (right) Hinge Screw, for 175-1 to 175-5, 175-7 to 175-9, 175-15, 175-16 and 175-18 Machines.....\$	15
U 8487	-----	U21906	Button Clamp (left) or (right) Hinge Screw Lock Screw, for 175-1 to 175-5, 175-7 to 175-9, 175-15, 175-16 and 175-18 Machines.....	15
U 8488	-----	U21906	Button Clamp (left) or (right) Screw Stud, for 175-1 to 175-5, 175-7 to 175-9, 175-15, 175-16 and 175-18 Machines.....	15
U 8489	175030	U21906	Button Clamp (right) Spring, for 175-1 and 175-3 Machines.....	
U 8490	175026	U21906	Button Clamp (left) Spring, for 175-1 and 175-3 Machines.....	
U 8491	-----	U21906	Button Clamp (left) or (right) Spring Screw for 175-1 to 175-5, 175-7 to 175-9, 175-15, 175-16 and 175-18 Machines.....	15
U 8495	680W	U21906	Button Clamp Adjusting Lever Thumb Screw, for 175-1 to 175-5, 175-7 to 175-9, 175-15, 175-16 and 175-18 Machines.....	
U 8499	175031	U21902	Button Clamp Adjusting Lever, for 175-1 to 175-5, 175-7 to 175-9, 175-15, 175-16 and 175-18 Machines.....	
U 8500	175362	U21940	Button Clamp Arm, for 175-10 to 175-14 Machines.....	
Note: Nos. 190J, 203K, 1492C, 1735J, 140064C and 140065C must be included when ordering 175362				
U 8501	175371	U21949	Button Holder, for 175-10 and 175-11 Machines.....	
U 8502	175372	U21949	Button Holder Spring, for 175-10 and 175-11 Machines.....	
U 8504	175366	U21949	Button Finger, for 175-10 to 175-12 Machines	
U 8505	-----	U21950	" " Hinge Screw, for 175-10 to 175-14 Machines.....	15
U 8506	175367	U21940	Button Finger Lever, for 175-10 and 175-14 Machines.....	
U 8507	-----	U21950	Button Finger Lever Hinge Screw, for 175-10 to 175-14 Machines.....	15
U 8508	-----	U21950	Button Finger Lever Hinge Screw Bracket, for 175-10 to 175-14 Machines.....	75
U 8510	175024	U21950	Button Finger Lever Hinge Screw Bracket Steady Pin, for 175-10 to 175-14 Machines	
U 8511	-----	U21950	Button Finger Lever Adjusting Screw, for 175-10 to 175-14 Machines.....	25
U 8512	-----	U21950	Button Finger Lever Adjusting Screw Nut, for 175-10 to 175-14 Machines.....	15
U 8513	-----	U21950	Button Finger Lever Screw Eye, for 175-10 to 175-14 Machines.....	50
U 8514	-----	U21950	Button Finger Lever Screw Eye Bushing, for 175-10 to 175-14 Machines.....	15
U 8518	175373	-----	Button Clamp complete for 175-10 and 175-11 Machines.....	
U 8519	175375	U21938	Needle Plate, for 175-10 to 175-14 Machines	

## Parts for Union Button Sewers

Osann No.	Singer No.	Plate	Name	Each
U 8520	175376	U21950	Needle Plate Work Support, for blind stitch, for 175-10 Machine.....\$	
U 8521	175377	U21950	Needle Plate Work Support, for through and through stitch, for 175-10 Machine.....	
U 8523	175380	U21950	Needle Plate Stay Button Holder and Work Support, for 18 ligne stay buttons, for 175-11 and 175-12 Machines.....	
U 8524	175381	-----	Needle Plate Stay Button Holder and Work Support, for 19 ligne stay buttons, for 175-11 and 175-12 Machines.....	
U 8525	175382	-----	Needle Plate Stay Button Holder and Work Support, for 20 ligne stay buttons, for 175-11 and 175-12 Machines.....	
U 8528	175365	U21940	Button Clamp Presser Bar, for 175-10 to 175-14 Machines.....	
U 8529	175364	U21940	Button Clamp Lifting Chain, 3 in. long, for 175-10 to 175-14 Machines.....	
U 8531	175383	U21949	Button Holder, for 175-12 Machine.....	
U 8532	175384	U21949	" " Spring, for 175-12 Machine...	
U 8533	175392	U21949	" " 7/32 in. hole, for 175-13 Machine.....	
U 8534	175391	U21949	Button Finger, for 175-13 and 175-14 Machines.....	
U 8535	175387	U21950	Bed Work Support, for 175-13 and 175-14 Machines.....	
U 8536	175389	U21950	Bed Work Support Holder, for 175-13 and 175-14 Machines.....	
U 8537	-----	U21949	Bed Work Support Holder Clamping Screw, for 175-13 and 175-14 Machines.....	15
U 8538	140066J	U21949	Bed Work Support Holder Guide Screw, for 175-13 and 175-14 Machines.....	
U 8539	175390	U21949	Bed Work Support Holder Lock Nut Screw Stud for 175-13 and 175-14 Machines.....	
U 8542	175393	U21949	Button Holder, 5/16 in. hole, for 175-13 Machine.....	
U 8543	175398	U21949	Button Holder, 3/8 in. hole, for 175-14 Machine.....	
U 8544	175399	U21949	Button Holder, 15/32 in. hole, for 175-14 Machine.....	
U 8545	175338	U21940	Button Clamp Lifting Chain, 3-1/4 in. long, for 175-6 Machine.....	
U 8547	175385	-----	Button Clamp complete, for 175-12 Machine..	
U 8548	175394	-----	Button Clamp complete, for 175-13 Machine..	
U 8549	175400	-----	Button Clamp complete, for 175-14 Machine..	
U 8550	175125	U21918	Needle Bar Vibrating Lever Adjusting Bracket Lock Nut Washer.....	
U 8551	175546	U21920	Needle Guide complete.....	
U 8555	175511	U21938	" Plate for 175-17 and 175-22 Machines	
U 8556	175137	U21949	" Guide Thread Finger.....	
U 8557	-----	U21949	" " " " Screw.....	15
U 8558	175132	U21918	" " Oscillating Crank.....	
U 8559	-----	U21918	" " " " Clamping Screw	15



## Parts for Union Button Sewers

Osann No.	Singer No.	Plate	Name	Each
U 8560	175134	U21918	Needle Guide Oscillating Crank Spring Hook (crank end).....\$	
U 8561	175130	U21918	Needle Guide Cam.....	
U 8563	175138	U21925	" Plate, for 175-1, 175-3 to 175-9, 175-15, 175-16 and 175-18 Machines.....	
U 8565	-----	U21916	Needle Bar Eccentric Connecting Rod Hinge Screw Nut.....	15
U 8566	175091	U21914	Looper Driving Shaft Gear.....	
U 8567	175143	U21914	Pulley Shaft Gear.....	
U 8568	175144	U21914	" " " Pin.....	
U 8569	175087	U21910	Looper Driving Shaft Bushing.....	
U 8575	175094	U21918	Needle Guide Shaft Bushing.....	
U 8576	140039C	U21921	Starting Crank Adjusting Screw.....	
U 8577	1747J	U21921	" " " " Nut.....	
U 8580	175344	U21908	Face Plate complete for 175-7 and 175-18 Machines.....	
U 8581	175469	U21939	Face Plate complete for 175-17, 175-19, 175-20 and 175-22 Machines.....	
U 8582	175340	U21915	Arm Rock Shaft complete, for all Machines except 175-1 to 175-4 Machines.....	
U 8583	175348	U21916	Needle Bar Connecting Link, for all Machines except 175-1 to 175-4 Machines.....	
U 8584	175356	U21940	Feed Plate (18 ligne stay buttons) for 175-8 Machine.....	
U 8584	175559	-----	Feed Plate (19 ligne stay buttons) for 175-8 Machine.....	
U 8584	175560	-----	Feed Plate (20 ligne stay buttons) for 175-8 Machine.....	
U 8584	175561	-----	Feed Plate (22 ligne stay buttons) for 175-8 Machine.....	
U 8587	-----	U21903	Feed Plate Screw, for 175-8 Machine.....	15
U 8588	175357	U21926	" " Lock Washer, for 175-8 Machine.....	
U 8591	175363	U21940	Button Clamp Arm Hinge Bracket, for 175-10 to 175-14 and 175-21 Machines.....	
U 8593	175487	U21940	Clamp (lower) Hinge Bracket, for 175-21 Machine.....	
U 8594	140072C	U21926	Clamp (lower) Screw, for 175-21 Machine....	
U 8596	175492	U21947	" Opening Pawl Ratchet, for 175-21 Machine.....	
U 8597	-----	U21947	Clamp Opening Pawl Hinge Bracket Screw, for 175-21 Machine.....	15
U 8598	175491	U21947	Clamp Opening Pawl Hinge Bracket, for 175-21 Machine.....	
U 8600	175490	U21947	Clamp Opening Pawl, for 175-21 Machine....	
Note: Nos. 140075C and 140076C must be included when ordering 175490.				
U 8601	-----	U21947	Clamp Opening Pawl Hinge Screw Stud, for 175-21 Machine.....	15
U 8602	175494	U21947	Clamp Opening Pawl Spring, for 175-21 Machine.....	
U 8603	175493	U21947	Clamp Opening Pawl Releaser, for 175-21 Machine.....	

## Parts for Union Button Sewers

Osann No.	Singer No.	Plate	Name	Each
U 8604	-----	U21947	Clamp Opening Pawl Releaser Screw, for 175-21 Machine.....\$	15
U 8608	175291	U21924	Clamp Opening Pin Connection Holder Screw Stud, for 175-3 Machine.....	
U 8617	175507	U21937	Button Clamp Feed Cam, for 175-22 Machine..	
U 8619	175361	U21939	Bed Top Cover (back) for 175-10 to 175-14 and 175-21 Machines.....	
U 8620	175506	U21943	Needle Bar (hollow) for 175-17 and 175-22 Machines.....	
U 8621	175410	U21944	Bed Top Cover (front) for 175-16 and 175-18 Machines.....	
U 8622	175415	U21944	Feed Plate (18 ligne stay buttons) complete for 175-16 Machine.....	
U 8623	140069W	U21926	Feed Plate Stay Button Holder Hinge Screw, for 175-16 Machine.....	
U 8624	140070J	U21926	Feed Plate Stay Button Holder Position Screw, for 175-16 Machine.....	
U 8625	175402	U21928	Button Clamp Leveling Foot (low foot) for 175-15 and 175-18 Machines.....	
U 8626	175411	U21928	Button Clamp Leveling Foot (double) high foot, for 175-46 Machine.....	
U 8627	-----	U21928	Button Clamp Leveling Foot Position Screw, for 175-15, 175-16 and 175-18 Machines..	15
U 8628	-----	U21928	Button Clamp Leveling Foot Thumb Screw, for 175-15, 175-16 and 175-18 Machines.....	25
U 8629	1620J	U21926	Feed Plate Stay Button Holder Hinge Screw Nut, for 175-16 Machine.....	
U 8630	175404	U21925	Feed Plate, for 175-15 Machine.....	
U 8631	175142	U21919	Pulley Shaft.....	
U 8632	175523	U21944	Button Clamp Carrier Regulator complete, for 175-17 and 175-22 Machines.....	
U 8633	175108	U21917	Needle Bar Eccentric Pawl.....	
U 8635	175484	U21947	Face Plate Thread Nipper Releasing Rod Trip Lever Block, for 175-17 and 175-20 Machines.....	
U 8638	175558	U21937	Button Clamp Feed Cam, for 175-17 Machine..	
U 8639	175503	U21944	" " Holder, for 175-17 and 175-22 Machines.....	
Note: Two No. 228J must be included when ordering 175503.				
U 8640	175498	U21947	Button Clamp (back) for 175-17 and 175-22 Machines.....	
U 8641	175500	U21947	Button Clamp (front) 1/16 in. thick, for 175-17 and 175-22 Machines.....	
U 8641	175510	U21947	Button Clamp (front) 1/8 in. thick, for 175-17 and 175-22 Machines.....	
U 8641	175519	U21947	Button Clamp (front) 5/32 in. thick, for 175-22 Machine.....	
U 8643	175342	U21915	Button Clamp Lifting and Thread Pull-off Holder Shaft, for 175-7, 175-17 to 175-20 and 175-22 Machines.....	
U 8644	175396	U21943	Needle Bar, for 175-10 to 175-14 Machines..	

Parts for Union Button Sewers

Osann No.	Singer No.	Plate	Name	Each
U 8645	175473	U21942	Face Plate Thread Nipper Releasing Rod, for 175-17, 175-19, 175-20 and 175-22 Machines.....\$	
U 8646	175476	U21942	Face Plate Thread Nipper Releasing Rod Bracket (front) for 175-17,175-19,175-20 and 175-22 Machines.....\$	
U 8647	175474	U21942	Face Plate Thread Nipper Releasing Rod Bracket (back) for 175-17, 175-19,175-20 and 175-22 Machines.....	
U 8649	175483	U21938	Needle Plate, for 175-19 to 175-21 Machines	
U 8650	175480	U21942	Face Plate Thread Nipper Releasing Rod Trip Lever, for 175-17, 175-19, 175-20 and 175-22 Machines.....	
U 8651	-----	U21947	Face Plate Thread Nipper Releasing Rod Trip Lever Clamping Screw, for 175-17, 175-19 175-20 and 175-22 Machines.....	15
U 8652	175478	U21944	Face Plate Thread Nipper Releasing Rod Spring, for 175-17, 175-19, 175-20 and 175-22 Machine.....	
U 8655	175471	U21946	Face Plate Thread Nipper Plate, for 175-17, 175-19, 175-20 and 175-22 Machines.....	
U 8656	175239	U21946	Face Plate Thread Nipper Spring, for 175-2, 175-17, 175-19, 175-20 and 175-22 Machines.....	
U 8657	-----	U21946	Face Plate Thread Nipper Plate Spring Screw for 175-2, 175-17, 175-19, 175-20 and 175-22 Machines.....	15
U 8658	-----	U21946	Face Plate Thread Nipper Body, for 175-17, 175-19, 175-20 and 175-22 Machines.....	35
U 8660	175472	U21946	Face Plate Thread Nipper Releasing Spring, for 175-17, 175-19, 175-20 and 175-22 Machines.....	
U 8663	175349	U21915	Needle Bar Connecting Stud (lower) for all Machines except 175-1 to 175-4 Machines.	
U 8666	175353	-----	Thread Retainer complete for 175-7, 175-17, 175-19, 175-20 and 175-22 Machines.....	
U 8667	-----	U21926	Thread Retainer Lever Screw, for 175-7, 175-17, 175-19, 175-20 and 175-22 Machines.....	15
U 8668	175374	U21942	Needle Bar Vibrating Cam Driving Worm Wheel Shaft, for 175-10 to 175-14 and 175-21 Machines.....	
U 8669	-----	U21926	Thread Retaining Spring Screw, for 175-7, 175-17, 175-19, 175-20 and 175-22 Machines.....	15
U 8673	-----	U21912	Needle Bar Vibrating Cam, for 175-3 Machine	5 00
U 8674	175293	U21909	Feed Cam, for 175-3 Machine.....	
U 8675	175072	U21905	" Plate, for 175-1 and 175-3 Machines...	
U 8677	175286	U21925	Clamp (upper) for 175-3 Machine.....	
Note: No. 231J must be included when ordering 175286.				
U 8678	175282	U21925	Clamp (lower) for size "0" snaps, for 175-3 Machine.....	

Parts for Union Button Sewers

Osann No.	Singer No.	Plate	Name	Each
U 8679	175283	U21925	Clamp (lower) for size "00" snaps, for 175-3 Machine.....\$	
U 8680	175284	U21925	Clamp (lower) for size "000" snaps, for 175-3 Machine.....	
U 8681	175290	U21924	Clamp Opening Pin Connection, for 175-3 Machine.....	
U 8683	175288	U21924	Clamp Opening Pin, for 175-3 Machine.....	
U 8686	-----	U21936	Needle Bar Vibrating Cam, for 175-19 and 175-22 Machines.....	5 00
U 8687	175479	U21947	Face Plate Thread Nipper Releasing Rod Trip Lever Trip Block, for 175-19 and 175-22 Machines.....	
U 8690	175440	U21937	Clamp Feed Cam, for 175-19 Machine.....	
U 8691	175527	U21945	" Presser Bar Screw Bearing, for 175-21 Machine.....	
U 8692	-----	U21943	Needle Bar Vibrating Lever, for 175-19 and 175-20 Machines.....	5 00
U 8693	175456	U21943	Clamp Swivel Bracket, for 175-19 and 175-20 Machines.....	
U 8695	175458	U21943	Clamp Vibrating Lever, for 175-19 and 175-20 Machines.....	
U 8696	175461	U21945	Clamp Vibrating Lever Swivel Block (front) for 175-19 and 175-20 Machines.....	
U 8697	1400740	U21945	Clamp Vibrating Lever Swivel Block (back) Hinge Screw Stud, for 175-19 and 175-20 Machines.....	
U 8698	175509	U21945	Clamp Vibrating Lever Swivel Block (front) Hinge Screw Washer, for 175-19 and 175-20 Machines.....	
U 8699	175459	U21945	Clamp Vibrating Lever Swivel Block (back) for 175-19 and 175-20 Machines.....	
U 8700	175460	U21945	Clamp Vibrating Lever Swivel Block (back) Hinge Screw Stud, for 175-19 and 175-20 Machines.....	
U 8703	175442	U21943	Clamp Arm Bracket, for 175-19 and 175-20 Machines.....	
U 8706	175441	U21943	Clamp Arm, for 175-19 and 175-20 Machines..	
Note: Nos. 1400730 and two 1400200 must be included when ordering 175441.				
U 8707	175465	U21943	Clamp Wire Holder (right) for 175-19 and 175-20 Machines.....	
U 8708	175463	U21943	Clamp Wire Holder (left) for 175-19 and 175-20 Machines.....	
U 8711	175453	U21943	Clamp Spreader, for 175-19 and 175-20 Machines.....	
U 8714	175454	U21945	Clamp Spreader Handle, for 175-19 and 175-20 Machines.....	
U 8715	175449	U21942	Clamp Opening Lever, for 175-19 and 175-20 Machines.....	
U 8716	-----	U21924	Clamp Opening Lever Hinge Screw Stud, for 175-19 and 175-20 Machines.....	25

## Parts for Union Button Sewers

Osann No.	Singer No.	Plate	Name	Each
U 8717	175444	U21945	Clamp Closing Spring, for 175-19 and 175-20 Machines.....	\$
U 8718	175452	U21945	Clamp Presser Bar Housing and Clamp Vibrating Lever Shaft Screw Bearing, for 175-19 and 175-20 Machines.....	
U 8720	175451	U21942	Clamp Presser Bar Housing and Clamp Vibrating Lever Shaft, for 175-19 and 175-20 Machines.....	
U 8721	175508	U21945	Clamp Presser Bar Collar, for 175-19 and 175-20 Machines.....	
U 8723	175450	U21945	Clamp Presser Bar, for 175-19 and 175-20 Machines.....	
U 8725	175443	U21935	Clamp Carrier, for 175-19 and 175-20 Machines.....	
U 8726	175247	U21935	Feed Plate Carrier Guide Block (right) for 175-2, 175-19 and 175-20 Machines.....	
U 8727	175246	U21935	Feed Plate Carrier Guide Block (left) for 175-2, 175-19 and 175-20 Machines.....	
U 8729	175456	U21945	Clamp Swivel Bracket Hinge Screw Stud, for 175-19 and 175-20 Machines.....	
U 8731	175457	U21945	Clamp Swivel Bracket Hinge Screw Stud Collar, for 175-19 and 175-20 Machines.....	
U 8734	175488	U21942	Clamp (upper) for 175-21 Machine.....	
U 8735	175486	U21942	" (lower) for 175-21 Machine.....	
U 8738	175059	-----	Button Clamp complete (less Arm) for 175-1 and 175-3 Machines.....	
U 8739	175304	-----	Button Clamp complete (less Arm) for 175-4, 175-5 and 175-7 to 175-9 Machines.....	
U 8742	175504	-----	Button Clamp complete for 175-22 Machine...	
U 8743	175495	-----	Clamp complete for 175-21 Machine.....	
U 8745	175292	-----	Clamp complete for 175-3 Machine.....	
U 8747	175468	-----	Clamp complete for 175-19 and 175-20 Machines.....	
U 8750	-----	U21912	Needle Bar Vibrating Cam, for 175-4, 175-8, 175-10 to 175-12 and 175-14 to 175-16 Machines.....	5 00
U 8751	175355	U21912	Feed Cam, for 175-4, 175-8, 175-15 and 175-16 Machines.....	
U 8752	-----	U21911	Needle Bar Vibrating Cam, for 175-5 and 175-6 Machines.....	5 00
U 8753	175306	U21911	Feed Cam, for 175-5 and 175-6 Machines.....	
U 8754	-----	U21913	Needle Bar Vibrating Cam, for 175-9, 175-17 and 175-20 Machines.....	5 00
U 8756	175346	U21911	Feed Cam Driving Worm, for 175-7, 175-9, 175-18 and 175-20 Machines.....	
U 8757	175359	U21909	Feed Cam Driving Worm Wheel, for 175-9, 175-17 and 175-20 Machines.....	

Note: Two No. 127J must be included when ordering 175359.

U 8758 175347 U21911 Feed Cam Driving Worm Wheel, for 175-7 and 175-18 Machines.....

Note: Two No. 127J must be included when ordering 175347.

## Parts for Union Button Sewers

Osann No.	Singer No.	Plate	Name	Each
U 8759	-----	U21913	Needle Bar Vibrating Cam, for 175-7 Machine	\$ 5 00
U 8760	175345	U21911	Feed Cam, for 175-7, 175-9 and 175-18 Machines.....	
U 8761	175654	-----	Button Clamp complete for 175-6 Machine....	
Note: Nos. 175042 and 175052 must be included when ordering 175654.				
U 8764	175485	U21937	Clamp Feed Cam, for 175-20 Machine.....	
U 8765	-----	U21936	Needle Bar Vibrating Cam, for 175-21 Machine	5 00
U 8767	175447	U21937	Clamp Feed Cam Driving Worm, for 175-19 and 175-22 Machines.....	
U 8768	175448	U21937	Clamp Feed Cam Driving Worm Wheel, for 175-19 and 175-22 Machines.....	
Note: Two No. 127J must be included when ordering 175448.				
U 8769	175515	U21937	Needle Bar Vibrating Cam Worm Wheel, for 175-21 Machine.....	
U 8770	175544	-----	Belt and Pulley Guard complete.....	
U 8771	140017E	U21901	Arm Screw (long).....	
U 8772	670E	U21901	" " (short).....	
U 8773	175352	U21926	Thread Retainer Lever Holder, for 175-7, 175-17, 175-19, 175-20 and 175-22 Machines.....	
U 8774	175351	U21925	Thread Retainer Lever, for 175-7, 175-17, 175-19, 175-20 and 175-22 Machines.....	
U 8775	175354	U21926	Thread Retaining Spring, for 175-7, 175-17, 175-19, 175-20 and 175-22 Machines.....	
U 8778	175417	U21940	Feed Plate Stay Button Holder (18 ligne stay buttons) for 175-16 and 175-18 Machines.....	
U 8779	175414	U21940	Feed Plate, for 175-16 Machine.....	
U 8783	175289	U21924	Clamp Opening Pin Collar, for 175-3 Machine	
U 8785	175287	U21924	" Lifting Chain Connection, for 175-3 Machine.....	
U 8786	175297	U21925	Clamp Opening Pin Plate, for 175-3 Machine.....	
U 8794	175634	U21938	Pulley, 3-1/4 in. diam.....	
U 8795	175636	U21938	" 3-3/4 in. diam.....	
U 8798	-----	U21936	Needle Bar Vibrating Cam, for 175-2 Machine	
U 8799	175241	U21938	Feed Cam, for 175-2 Machine.....	
U 8800	175266	U21941	Needle Plate, for 175-2 Machine.....	
U 8801	175545	U21948	Knife (stationary) lower, complete for 175-2 Machine.....	
U 8804	175251	U21948	Knife (movable) for 175-2 Machine.....	
U 8805	140097E	U21948	" " Screw, for 175-2 Machine....	
U 8806	175252	U21935	" " Bar, for 175-2 Machine.....	
U 8807	175254	U21935	" " " Guide (right) for 175-2 Machine.....	
U 8808	175253	U21935	Knife (movable) Bar Guide (left) for 175-2 Machine.....	
U 8809	175233	U21941	Bed Top Cover, for 175-2 Machine.....	
U 8810	175281	U21948	Knife (movable) Bar Screw Stud, for 175-2 Machine.....	
U 8811	175258	U21935	Knife (movable) Driving Lever Extension, for 175-2 Machine.....	

## Parts for Union Button Sewers

Osann No.	Singer No.	Plate	Name	Each
U 8812	175257	U21935	Knife (movable) Driving Lever Arm, for 175-2 Machine.....\$	
U 8813	140053C	U21948	Knife (movable) Driving Lever Arm Hinge Screw, for 175-2 Machine.....	
U 8814	175256	U21935	Knife (movable) Driving Lever, for 175-2 Machine.....	
U 8815	140054C	U21948	Knife (movable) Driving Lever Hinge Screw, for 175-2 Machine.....	
U 8816	51924	U21948	Knife (movable) Driving Lever Roller and Screw Stud, for 175-2 Machine.....	
U 8817	175259	U21935	Knife (movable) Driving Lever Plate, for 175-2 Machine.....	
U 8818	175255	U21938	Knife (movable) Cam, for 175-2 Machine.....	
U 8819	175267	U21948	Needle Guide Thread Finger, for 175-2 Machine.....	
U 8821	175273	U21941	Thread Pull-off (front) for 175-2 Machine..	
U 8822	175274	U21948	" " " Holder, for 175-2 Machine.....	
U 8823	175275	U21948	Thread Pull-off (front) Releasing Arm, for 175-2 Machine.....	
U 8824	175279	U21948	Thread Pull-off (front) Spring, for 175-2 Machine.....	
U 8825	175280	U21948	Thread Pull-off (front) Spring Screw Stud, for 175-2 Machine.....	
U 8826	175245	U21941	Feed Plate Carrier, for 175-2 Machine.....	
U 8827	-----	U21949	" " " Regulating Handle Screw Stud, for 175-2 Machine, obsolete, use 51667C, 175548 and 175549.....	--
U 8828	175250	U21945	Feed Plate Carrier Regulating Handle Screw Stud Nut Washer, for 175-2 Machine.....	
U 8830	-----	U21949	Feed Plate Carrier Regulating Handle Screw Stud Cap Screw, for 175-2 Machine.....	--
U 8831	175248	U21942	Feed Plate Carrier Regulating Handle, for 175-2 Machine.....	
U 8833	175268	U21941	Slack Thread Regulator Lever, for 175-2 Machine.....	
U 8834	140055C	U21948	Slack Thread Regulator Lever Hinge Screw, for 175-2 Machine.....	
U 8835	175269	-----	Slack Thread Regulator Lever complete, for 175-2 Machine.....	
U 8836	140056C	U21948	Slack Thread Regulator Releasing Screw (lower end) for 175-2 Machine.....	
U 8837	175271	U21948	Slack Thread Regulator Lever Spring, for 175-2 Machine.....	
U 8838	175272	U21948	Slack Thread Regulator Lever Releasing Stud (cam end) for 175-2 Machine.....	
U 8839	175395	U21948	Thread Nipper Releasing Stud (cam end) for 175-2 Machine.....	
U 8840	175237	U21946	Face Plate Thread Nipper Body, for 175-2 Machine.....	
U 8841	175238	U21946	Face Plate Thread Nipper Plate, for 175-2 Machine.....	

## Parts for Union Button Sewers

Osann No.	Singer No.	Plate	Name	Each
U 8842	175244	U21941	Feed Plate, for 175-2 Machine.....\$	
U 8843	175243	U21937	" Cam Driving Worm Wheel, for 175-2 Machine.....	
Note: Two No. 127J must be included when ordering 175243.				
U 8844	175236	U21946	Face Plate Thread Knife, for 175-2 Machine..	
U 8845	175530	U21946	Stop Motion Trip Block, for 175-2 Machine..	
U 8846	1186E	U21946	" " " Screw, for 175-2 Machine..	
U 8847	175235	U21939	Face Plate complete for 175-2 Machine.....	
U 8848	175512	U21946	Slack Thread Regulator Lever Stop, for 175-2 Machine.....	
U 8849	175513	U21946	Slack Thread Regulator Lever Stop Screw Plate, for 175-2 Machine.....	
U 8850	175231	-----	Arm Side Cover (right) for 175-2 Machine...	
U 8851	175622	U21906	Button Clamp (left) or (right) Steady Pin, for 175-1 to 175-5, 175-7 to 175-9, 175-15, 175-16 and 175-18 Machines.....	
U 8852	175017	U21906	Bed End Cover (bottom) Spring Hook.....	
U 8853	175135	U21918	Needle Guide Oscillating Crank Spring Hook (bed end).....	
U 8855	175111	U21917	Needle Bar Eccentric Pawl Bracket Steady Pin.....	
U 8856	175190	U21924	Thread Pull-off (front) Holder Stop Pin, for all Machines except 175-2 Machine.....	
U 8857	175084	U21946	Feed Plate Carrier Regulator Spring Pin, for all Machines except 175-10 to 175-14 and 175-21 Machines.....	
U 8858	175424	U21930	Machine Starting Lever Spring Hook (short).	
U 8859	175210	U21930	" " " " " (long)..	
U 8860	175161	U21922	Tension (automatic) Disc Position Pin.....	
U 8862	175014	U21901	Bed End Cover (bottom) Hinge Pin (left)....	
U 8863	175475	U21946	Face Plate Thread Nipper Releasing Rod Bracket (back) Dowel Pin, for 175-19, 175-20 and 175-21 Machines.....	
U 8864	175015	U21901	Bed End Cover (bottom) Hinge Pin (right)...	
U 8865	175002	U21901	Arm Dowel Pin.....	
U 8866	175226	U21941	Button Clamp Arm, for 175-2 Machine.....	
U 8867	175517	U21905	" " (right) for 175-2 Machine.....	
U 8868	175419	U21905	" " (left) for 175-2 Machine.....	
U 8869	175518	U21906	" " (right) Spring, for 175-2 Machine.....	
U 8870	175420	U21906	Button Clamp (left) Spring, for 175-2 Machine.....	
U 8871	175445	U21946	Clamp Closing Spring Hook, for 175-19 and 175-20 Machines.....	
U 8876	175577	U21944	Feed Plate, for 175-18 Machine.....	
U 8878	175416	U21925	" " Work Support, for 175-16 and 175-18 Machines.....	
U 8879	175578	U21940	Feed Plate Hinge Bracket, for 175-7 and 175-18 Machines.....	
U 8880	175575	U21905	Button Clamp Arm 175-4, 175-5, 175-8, 175-9 and 175-18 Machines.....	

## Parts for Union Button Sewers

Osann No.	Singer No.	Plate	Name	Each
U 8881	175438	U21926	Feed Plate Pressure Regulating Thumb Nut Screw Stud, for 175-18 Machine.....\$	
U 8882	175439	U21926	Feed Plate Pressure Spring, for 175-18 Machine.....	
U 8883	51659J	U21926	Feed Plate Pressure Regulating Thumb Nut, for 175-18 Machine.....	
U 8884	175436	U21926	Feed Plate Latch, for 175-18 Machine.....	
U 8885	140071C	U21926	" " " Hinge Screw, for 175-18 Machine.....	
U 8886	175437	U21926	Feed Plate Latch Spring, for 175-18 Machine.....	
U 8887	175592	U21914	" " Carrier Regulating Screw Stud, for 175-18 Machine.....	
U 8888	51671C	U21914	Feed Plate Carrier Regulating Screw Stud Nut, for 175-18 Machine.....	
U 8889	175434	U21910	Feed Plate Carrier Guide Block (right) for 175-18 Machine.....	
U 8890	175427	U21908	Bed Top Cover (back) for 175-18 Machine....	
U 8891	175429	U21904	Button Clamp Spreader and Button Stop Base, for 175-18 Machine.....	
U 8892	175426	-----	Bed, for 175-18 Machine.....	
U 8893	140051C	U21946	Feed Plate Carrier Regulating Handle Screw Stud, for 175-2 Machine.....	
U 8894	175242	U21946	Feed Plate Carrier Regulating Handle Stop Screw Stud Nut Washer, for 175-2 Machine.....	
U 8895	51657J	U21946	Feed Plate Carrier Regulating Stop Screw Stud Nut, for 175-2 Machine.....	
U 8896	-----	U21913	Needle Bar Vibrating Cam, for 175-18 Machine ..	

## SINGER PARTS USED ON UNION BUTTON SEWERS

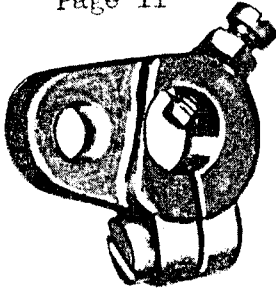
## WHICH DO NOT HAVE "U" NUMBERS.

No.	Plate	Name
186C	U21917	Needle Bar Vibrating Lever Adjusting Bracket Hinge Screw Set Screw.....
203K	U21924	Clamp Lifting Chain Connection Set Screw, for 175-3 Machine.....
208E	U21928	Thread Unwinder Thread Guide Rod Screw.....
218D	U21918	Needle Guide Thread Finger Screw.....
230J	U21901	Arm Side Cover (left) Screw.....
231J	U21924	Clamp (lower) Screw, for 175-3 Machine.....
1285C	U21914	Looper Driving Shaft Crank Position Screw.....
26026	U21929	Screw Driver.....
27739	U21933	Thread Unwinder Thread Cone (wood) for large cones.....
50090J	U21926	Feed Plate Work Support Screw, for 175-16 and 175-18 Machines.....
50365J	U21926	Thread Retaining Spring Adjusting Screw, for 175-7,175-17 to 175-20 and 175-22 Machines.....
56665	U21928	Foot Lifter and Starting Lever Chain Hook.....
120342	U21929	Oiler (copper plated) with Spout.....
120343	U21929	" Spout, 3-1/2 in. long.....
140029E	U21916	Needle Bar Eccentric Connecting Rod Cap Screw.....
150203	U21933	Thread Unwinder Spool Rest Cushion (felt).....
175007	U21901	Arm Rock Shaft Crank (front) Pin.....
175008	U21901	" Side Cover (left).....
175019	U21906	Bed Top Cover (back) Oil Tube, for 175-1, 175-3 to 175-9, 175-15 to 175-18 and 175-22 Machines.....
175096	U21916	Machine Rest Stud.....
175114	U21917	Needle Bar Eccentric Pawl Spring Stud.....
175131	U21918	" Guide Pin.....
175192	U21924	Thread Pull-off Stop Collar Stop Pin, for all Machines except 175-2 Machine.....
175194	U21929	Button Tray Hinge Screw Stud, for all Machines except 175-19 to 175-21 Machines.....
175202	U21930	Machine Base Machine Lock Plate Position Stud.....
175205	U21930	" " " " Stud.....
175206	U21930	" " " " Thumb Nut Screw Stud.....
175215	-----	Foot Lifter and Starting Lever Chain, 37 in. long, with hook.....
175216	U21931	Foot Lifter and Starting Lever Treadle.....
175217	U21931	" " " " " " Hinge Pin.....
175218	U21931	" " " " " " Stand.....
175227	U21931	Table Belt Guide Pulley Shaft Oil Wick.....
175228	U21931	Table Belt Guide complete.....
175267	U21948	Needle Guide Thread Finger, for 175-2 Machine.....
175285	U21924	Clamp (lower) Position Pin, for 175-2 Machine.....
175298	U21905	Button Clamp (left) complete for 175-4, 175-5, 175-7 to 175-9, 175-15, 175-16 and 175-18 Machines.....
175300	U21905	Button Clamp (right) complete for 175-4, 175-5, 175-7 to 175-9, 175-15, 175-16 and 175-18 Machines.....
175379	U21942	Plug, for Feed Plate Carrier Regulator Shaft Hole, for 175-10 to 175-14 and 175-21 Machines.....
175401	U21928	Button Clamp Leveling Foot (single, high foot) for 175-15, 175-16 and 175-18 Machines.....
175406	U21925	Feed Plate Work Support, for 175-15 Machine.....

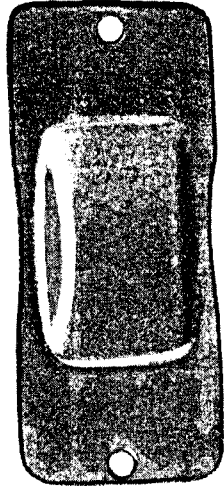
No.	Plate	Name
175407	U21926	Feed Plate Work Support Rivet, for 175-15 Machine.....
175412	U21928	Button Clamp Leveling Foot (double, low foot) for 175-16 and 175-18 Machines.....
175505	U21944	Button Clamp Carrier, for 175-17 and 175-22 Machines.....
Note: Two No. 228J must be included when ordering 175505.		
175514	U21945	Thread Nipper Releasing Stud, for 175-7, 175-9, 175-17 to 175-20 and 175-22 Machines.....
175531	U21935	Thread Nipper Releasing Lever, for 175-2 Machine.....
175534	U21945	" " " Screw Stud, for 175-7, 175-9, 175-17 to 175-20 and 175-22 Machines.....
175535	U21916	Needle Bar Eccentric Connecting Rod Oil Pad (felt).....
175537	U21932	Belt and Pulley Guard.....
175538	U21932	" " " " Fill-in Piece (metal) for Trough Power Tables.....
175539	U21932	Belt and Pulley Guard Fill-in Piece (wood) for Flat Power Tables.....
175540	-----	Belt and Pulley Guard complete, for Individual Motor Tables.....
175541	U21932	Belt and Pulley Guard Hinge Pin.....
175542	U21932	" " " " " Bracket.....
175543	U21932	Belt and Pulley Guard Hinge Pin Bracket complete.....
175544	-----	Belt and Pulley Guard with Fill-in Pieces complete.....
175547	U21918	Needle Guide Thread Finger.....
175549	U21914	Feed Plate Carrier Regulating Nut Tightening Handle, for 175-1 to 175-9, 175-15 to 175-18 and 175-22 Machines.....
175573	U21903	Button Clamp Spreader Handle, for 175-2 Machine.....
175584	U21925	Feed Plate, for 175-8 and 175-9 Machines.....
175585	U21925	" " Stay Button Holder (18 ligne stay buttons) for 175-8 and 175-9 Machines.....
175586	-----	Feed Plate Stay Button Holder (19 ligne stay buttons) for 175-8 and 175-9 Machines.....
175587	-----	Feed Plate Stay Button Holder (20 ligne stay buttons) for 175-8 and 175-9 Machines.....
175588	-----	Feed Plate Stay Button Holder (22 ligne stay buttons) for 175-8 and 175-9 Machines.....
175589	U21925	Feed Plate Stay Button Holder Spring, for 175-8 and 175-9 Machines.....
175590	U21926	Feed Plate Stay Button Holder Stud, for 175-8 and 175-9 Machines.....
175593	U21923	Bed Top Cover (back) Oil Tube, for 175-10 to 175-14 and 175-21 Machines.....
200383C	U21928	Thread Unwinder Spool Rest Rod Set Screw.....
201018C	U21928	" " " " Set Screw.....
201696J	U21928	" " Thread Guide Lock Nut.....
202490	U21933	" " Spool Stand with 200383C.....
225259	U21933	" " Rest with 201018C.....
225260	U21933	Thread Unwinder complete.....
225322	U21928	" " Thread Guide Rod Washer.....
225324	U21933	" " " Rod.....
225388	U21933	" " Spool Rest Rod.....
225390	U21933	" " Thread Cone Holder, for inverted cones....
225391	U21933	" " " Guide.....

PLATE U 21901 - FULL SIZE


175005  
Page 11




175008  
Page 25



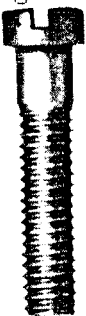
U 8258  
Page 11




U40016  
Page 11




U40017  
Page 21




670  
Page 21




175007  
Page 25




175002  
Page 23




175016  
Page 13




230  
Page 25




1521  
Page 6




51650  
Page 5



51649  
Page 5



175014  
Page 23



175015  
Page 23


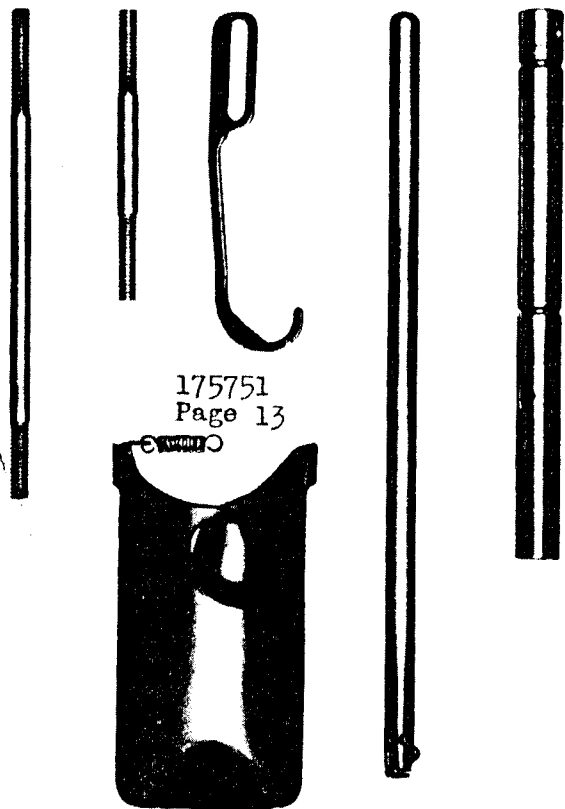


PLATE U 21902 - ONE-HALF SIZE

175010 Page 5   175011 Page 5   175031 Page 14   204383 Page 7   175071 Page 8



175751  
Page 13



175018  
Page 8

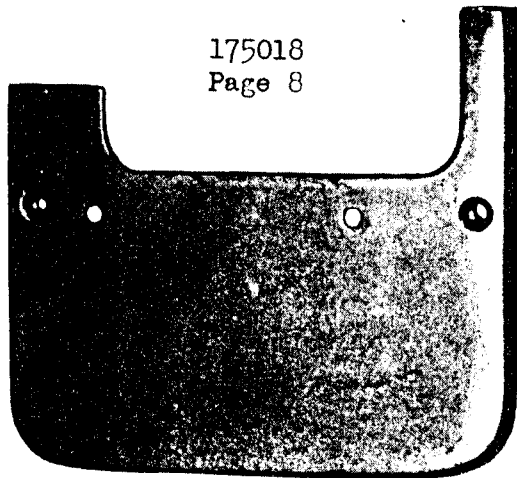
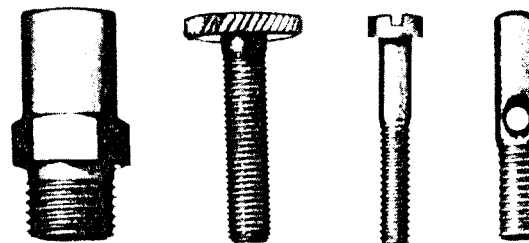


PLATE U 21903 - FULL SIZE

175054 Page 10   140023 Page 10   U 8012 Page 5   175066 Page 5



175062  
Page 5

U 8017  
Page 5

202098  
Page 5

175063  
Page 5



175065  
Page 5

U 8479  
Page 13

140026  
Page 11

175069  
Page 9



1722  
Page 6

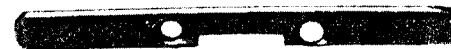
U 8161  
Page 9

51923  
Page 9

U 8587  
Page 10



175573  
Page 26



175058  
Page 13

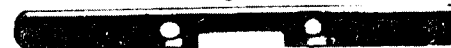
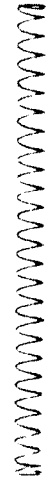


PLATE U 21904 - ONE-HALF SIZE

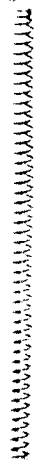
175047  
Page 6



175050  
Page 13



175055  
Page 10



175042  
Page 10



175052  
Page 12



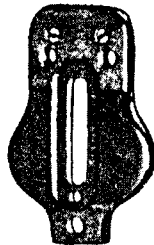
175048  
Page 6



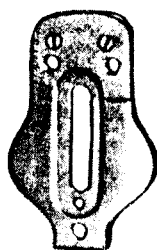
175041  
Page 5



175429  
Page 24



175057  
Page 13



175056  
Page 13



175302  
Page 13

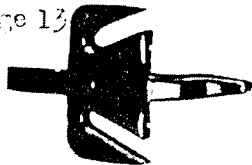


PLATE U 21905 - ONE-HALF SIZE

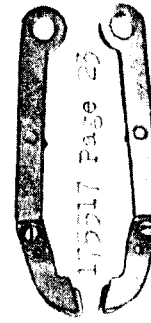
175022 Page 13



175023 Page 13



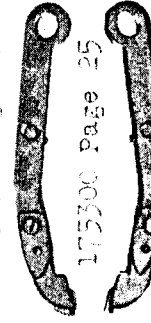
175419 Page 25



175517 Page 25

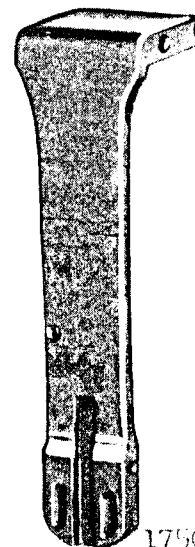


175298 Page 25

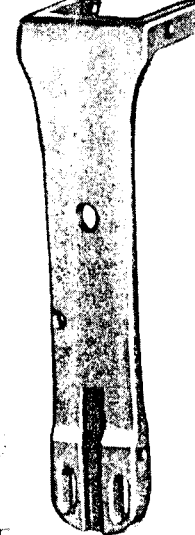


175300 Page 25

175033  
Page 10



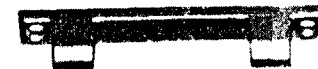
175575  
Page 25



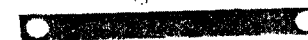
175072  
Page 13



175035  
Page 10



175036  
Page 11



175034  
Page 11

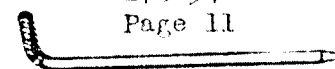




PLATE U 21906 - FULL SIZE

175017  
Page 23



175019  
Page 25



U 8144  
Page 8



U 8186  
Page 14



175420  
Page 23



175518  
Page 23



175026  
Page 14



175030  
Page 14



U 8487  
Page 14



U 8488  
Page 14



U 8491  
Page 14



175032  
Page 9



680  
Page 14



160  
Page 6



U 8137  
Page 8



U 8023  
Page 5



U 8025  
Page 5



50269  
Page 6



U 8180  
Page 13



U 8210  
Page 10

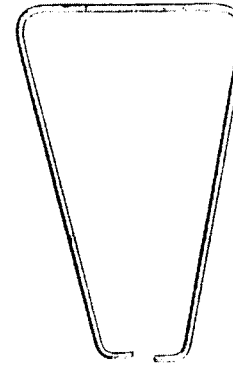


175022  
Page 23

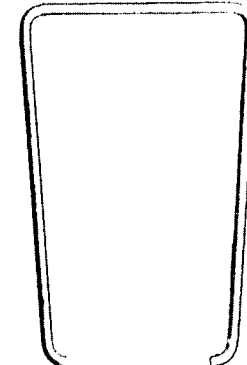


PLATE U 21907 - FULL SIZE

175040  
Page 13



175303  
Page 13



175044  
Page 5



175046  
Page 6



175045  
Page 6



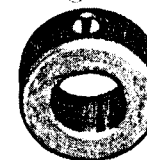
U 8021  
Page 5



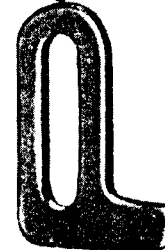
42830  
Page 6



175053  
Page 10



175049  
Page 13

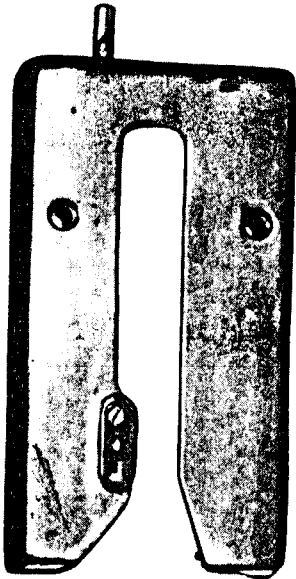


175051  
Page 12

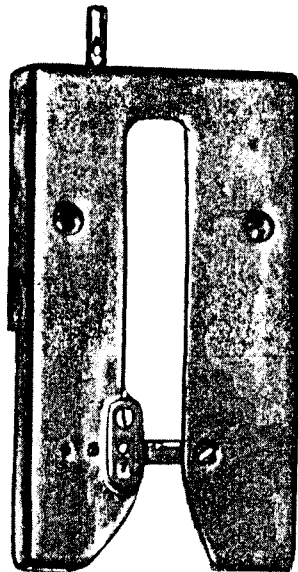


PLATE U 21908 - ONE-HALF SIZE

175061  
Page 5



175344  
Page 16



175427  
Page 24

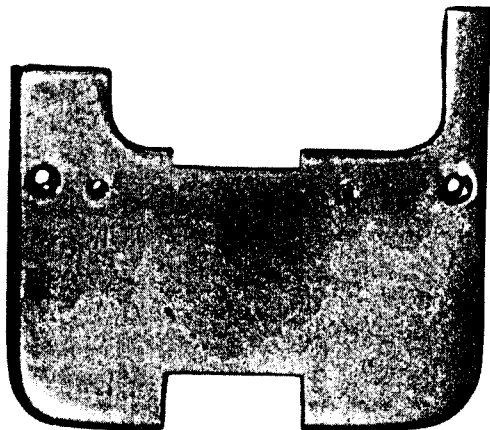
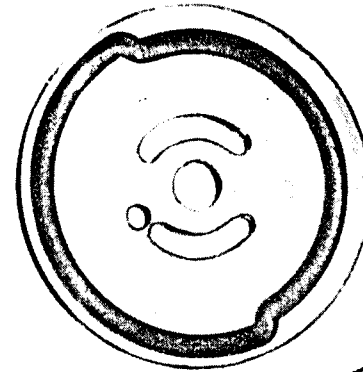


PLATE U 21909 - ONE-HALF SIZE

175067  
Page 9

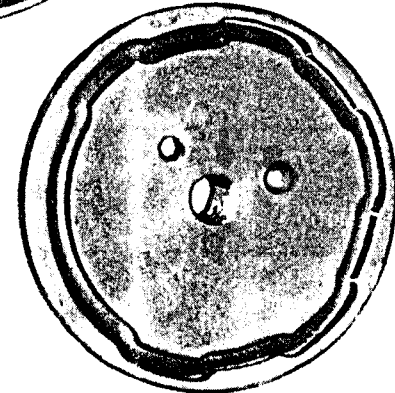


175070  
Page 11



# 8119  
Page 7

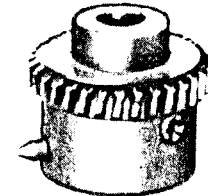
175068  
Page 11



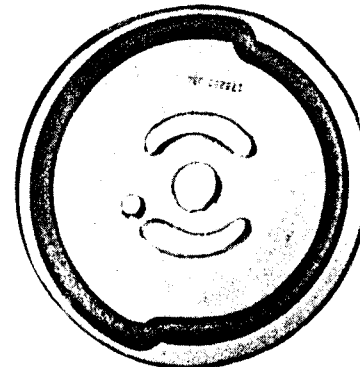
175294  
Page 11



175295  
Page 11



175293  
Page 18



175359  
Page 20

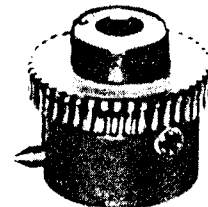


PLATE U 21910 - ONE-HALF SIZE

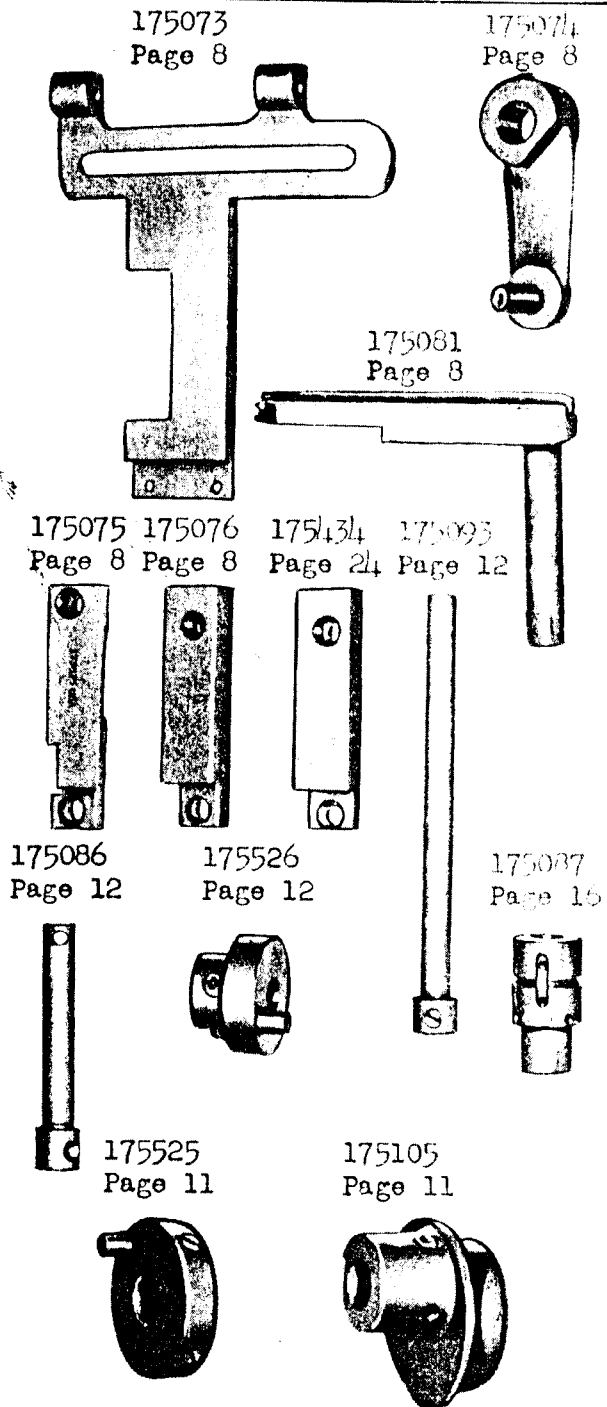


PLATE U 21911 - ONE-HALF SIZE

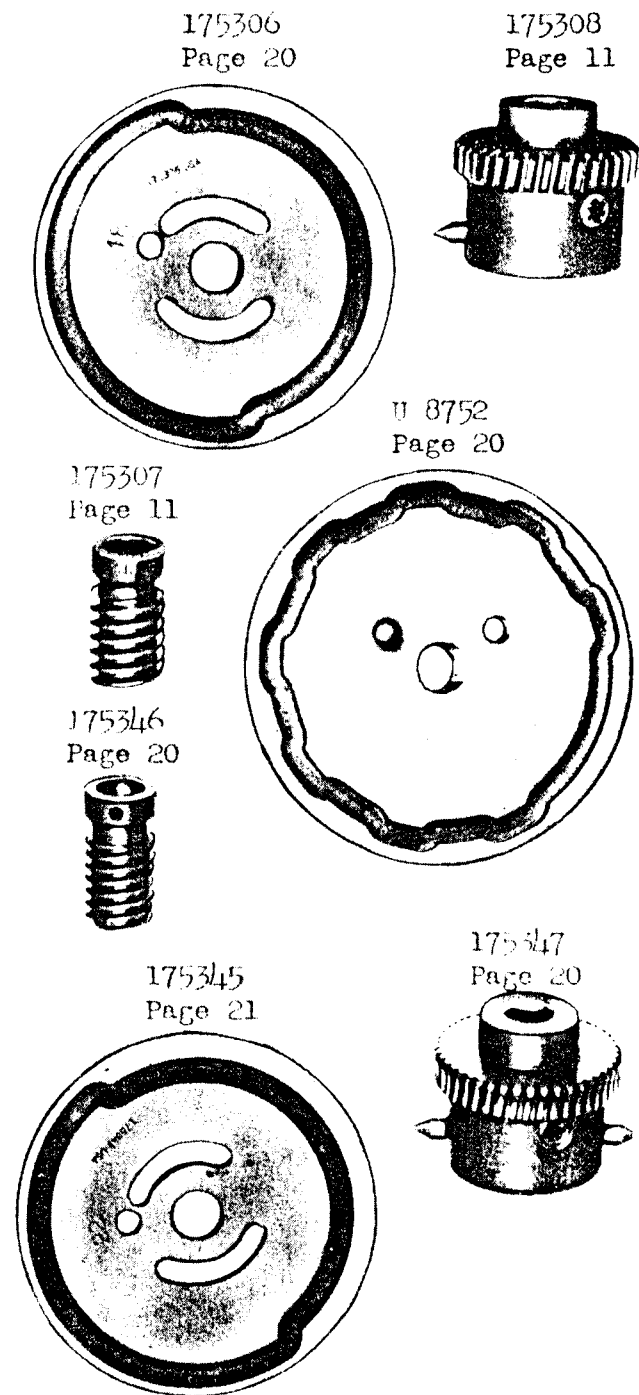
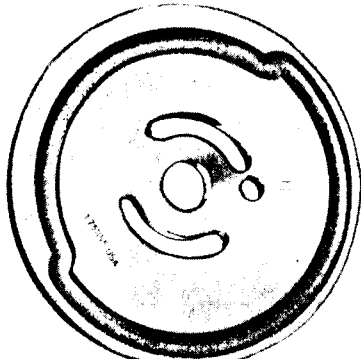
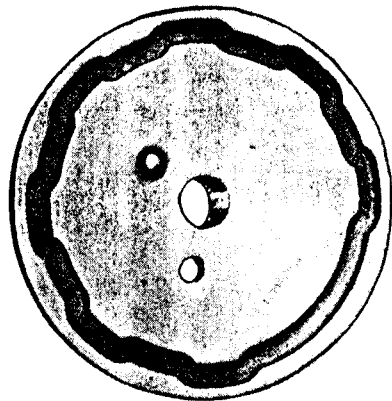


PLATE U 21912 - ONE-HALF SIZE

U 8673  
Page 18



U 8750  
Page 20



175355  
Page 20

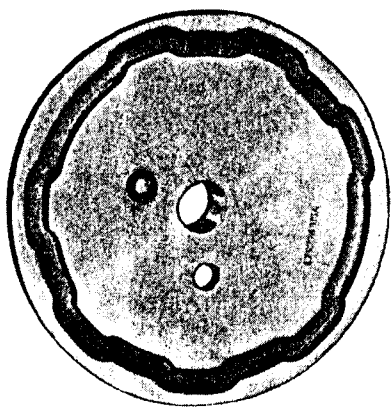
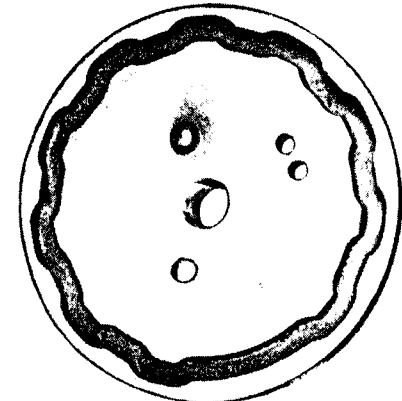
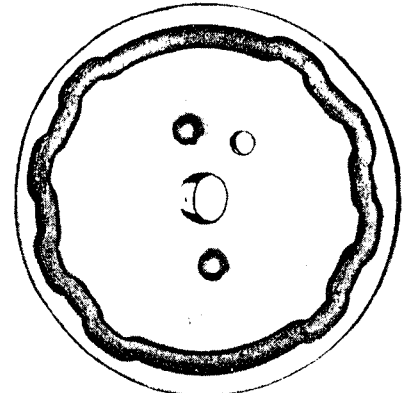


PLATE U 21913 - ONE-HALF SIZE

U 8754  
Page 20



U 8896  
Page 24



U 8759  
Page 21

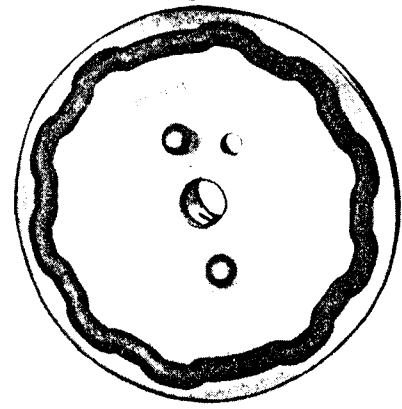


PLATE U 21914 - FULL SIZE

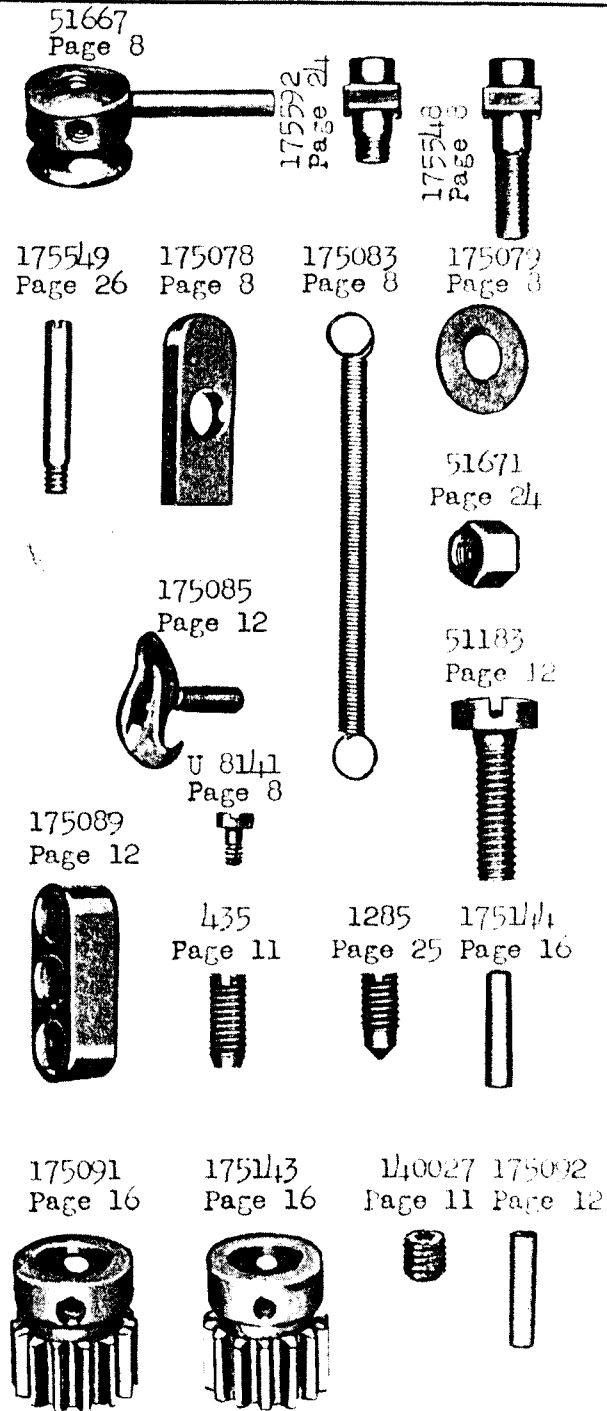


PLATE U 21915 - ONE-HALF SIZE

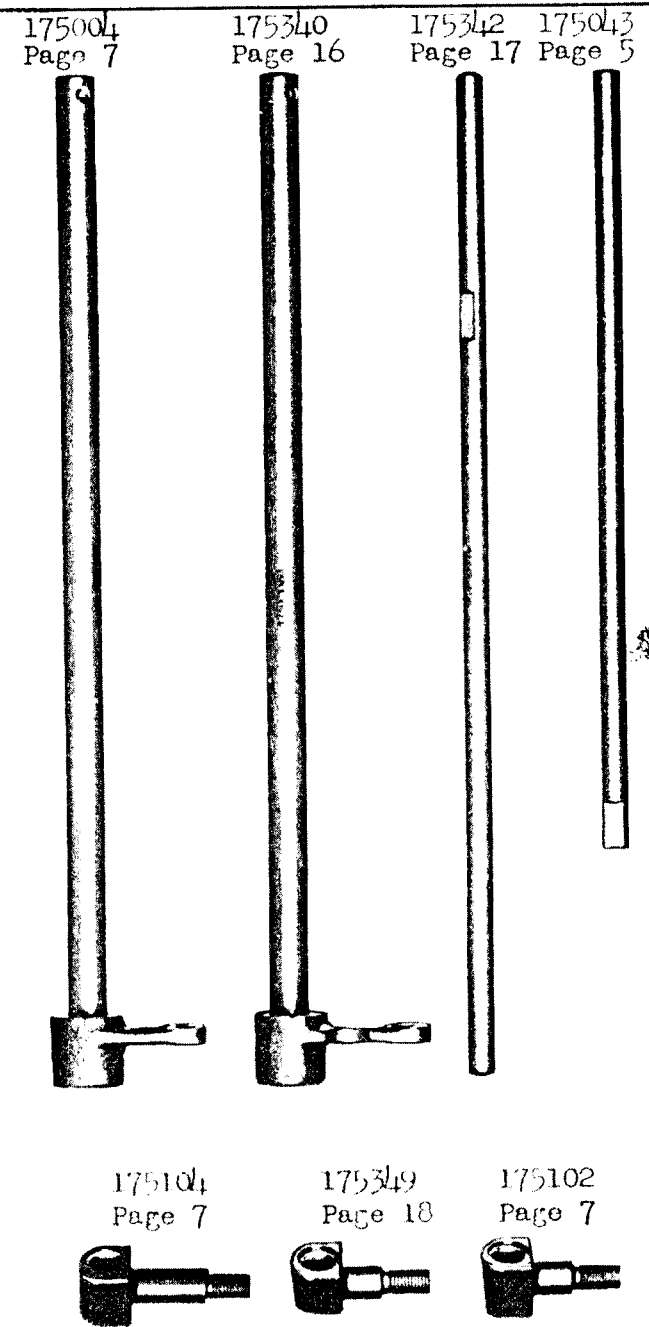
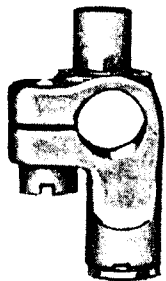


PLATE U 21916 - FULL SIZE

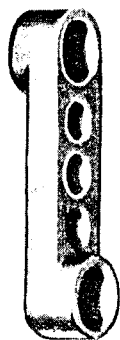
175629  
Page 7



175098  
Page 7



175318  
Page 16



140028  
Page 7



175096  
Page 25



175100  
Page 7



U 8087  
Page 7



U 8088  
Page 7



175103  
Page 7



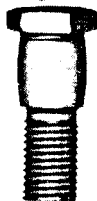
175101  
Page 7



140029  
Page 25



U 8253  
Page 11



U 8565  
Page 16



175135  
Page 20



PLATE U 21917 - FULL SIZE

175108  
Page 17



175110  
Page 13



134  
Page 13



175111  
Page 8



175111  
Page 23



175112  
Page 13



175114  
Page 25



175113  
Page 12



200150  
Page 7



200175  
Page 7



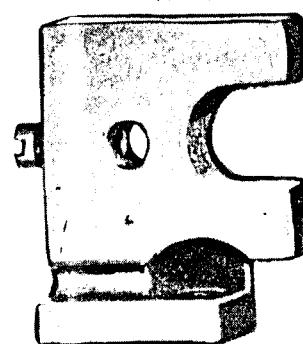
200125  
Page 6



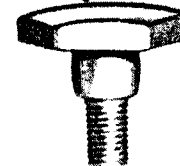
186  
Page 25



175121  
Page 7



140032  
Page 7



175124  
Page 11



PLATE U 21918 - FULL SIZE

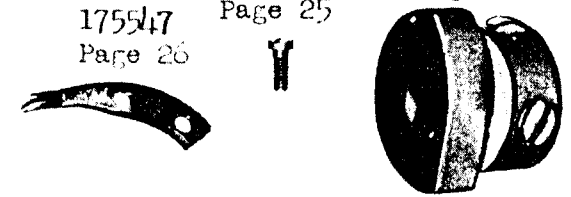
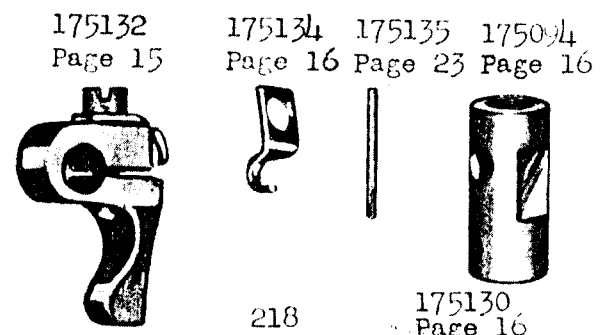
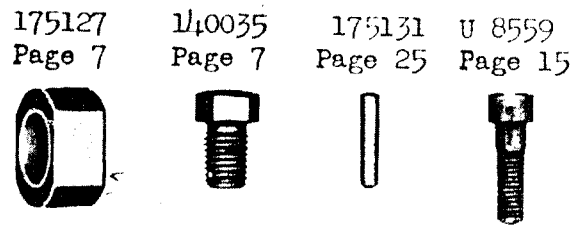
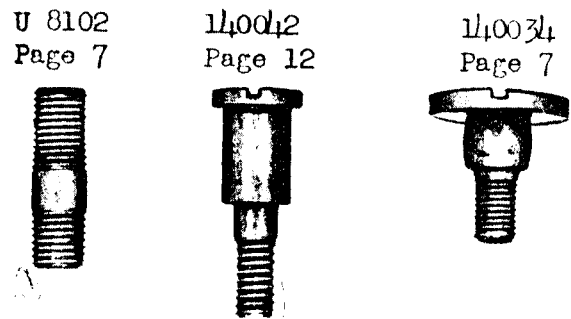
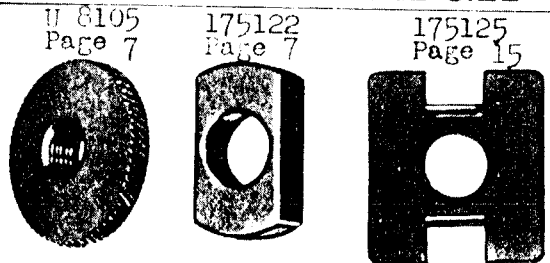


PLATE U 21919 - ONE-HALF SIZE

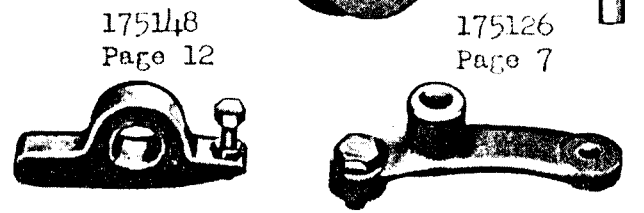
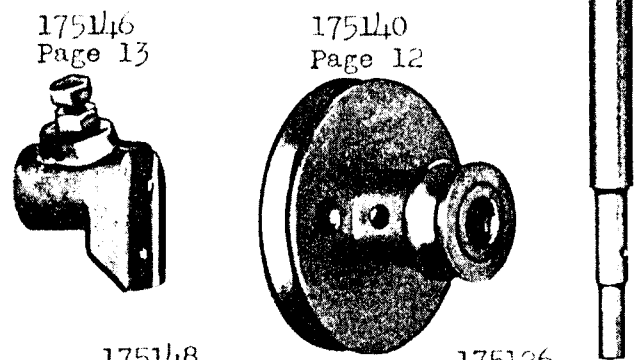
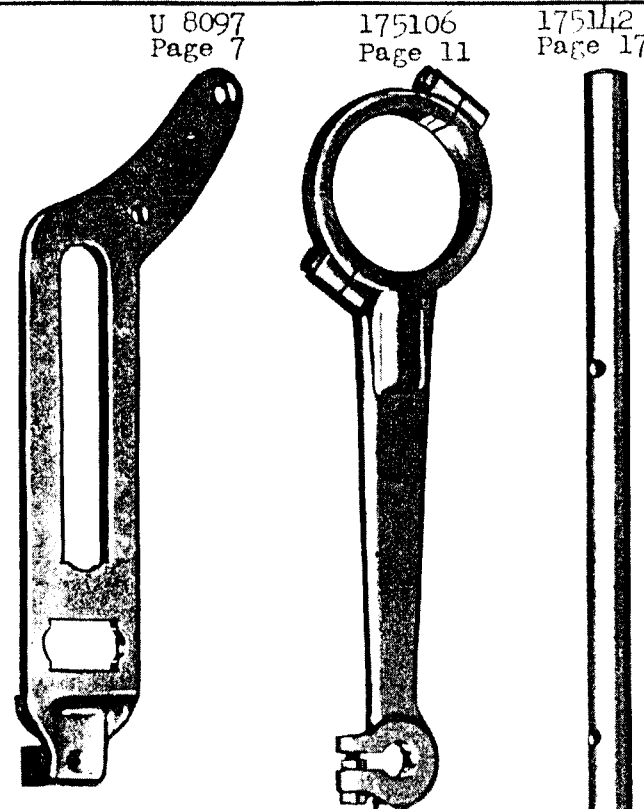
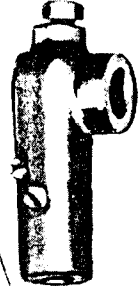


PLATE U 21920 - ONE-HALF SIZE

175150  
Page 12



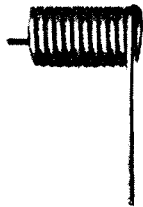
175152  
Page 12



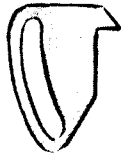
175155 175163  
Page 12 Page 6



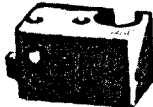
175156  
Page 12



175158  
Page 12



175159  
Page 12



175157  
Page 12



175186  
Page 5



175188  
Page 6



175146  
Page 15



175164  
Page 6

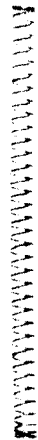
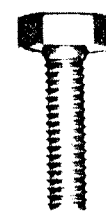


PLATE U 21921 - FULL SIZE

U 2151  
Page 15



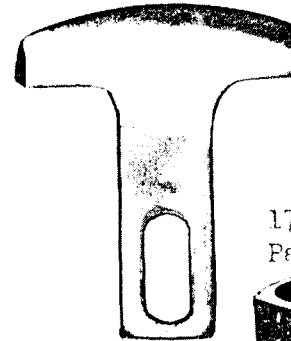
140037  
Page 12



175141 175149  
Page 13 Page 12



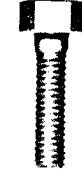
175145  
Page 13



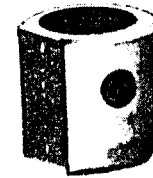
1173  
Page 13



140039  
Page 16



175153  
Page 12



51655  
Page 13



175171  
Page 12



140041  
Page 12



140040  
Page 12



1747  
Page 16



175229  
Page 11



50581  
Page 12



175154  
Page 12



U 2143  
Page 12



PLATE U 21922 - FULL SIZE

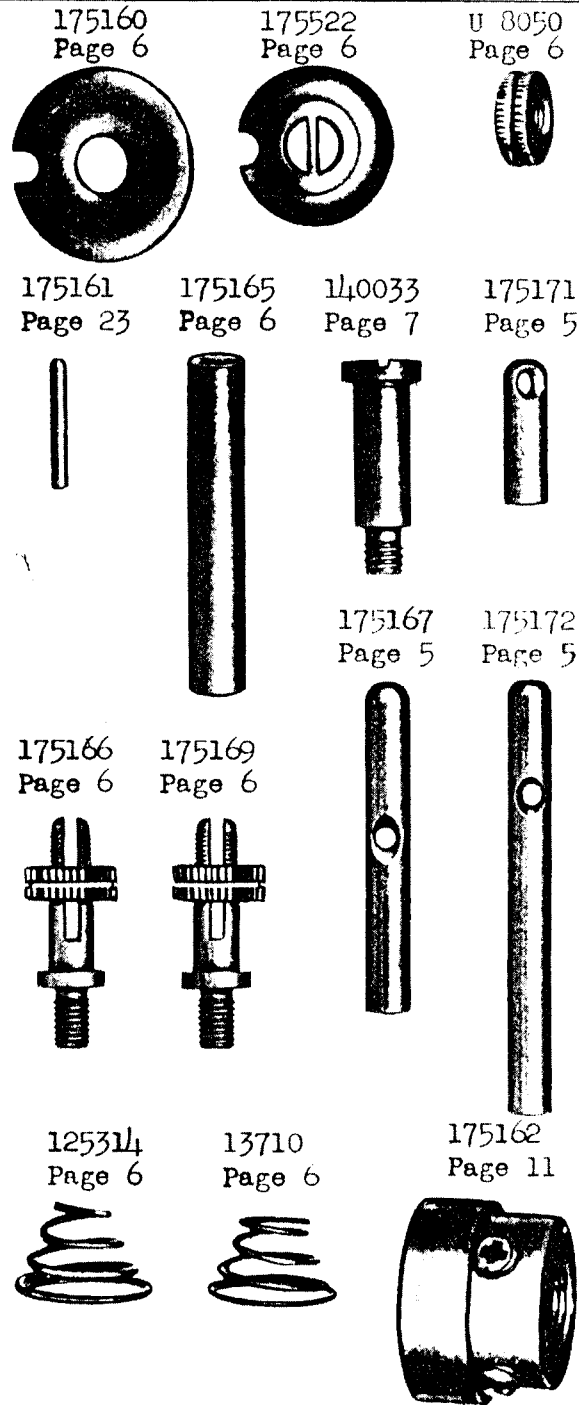


PLATE U 21923 - FULL SIZE

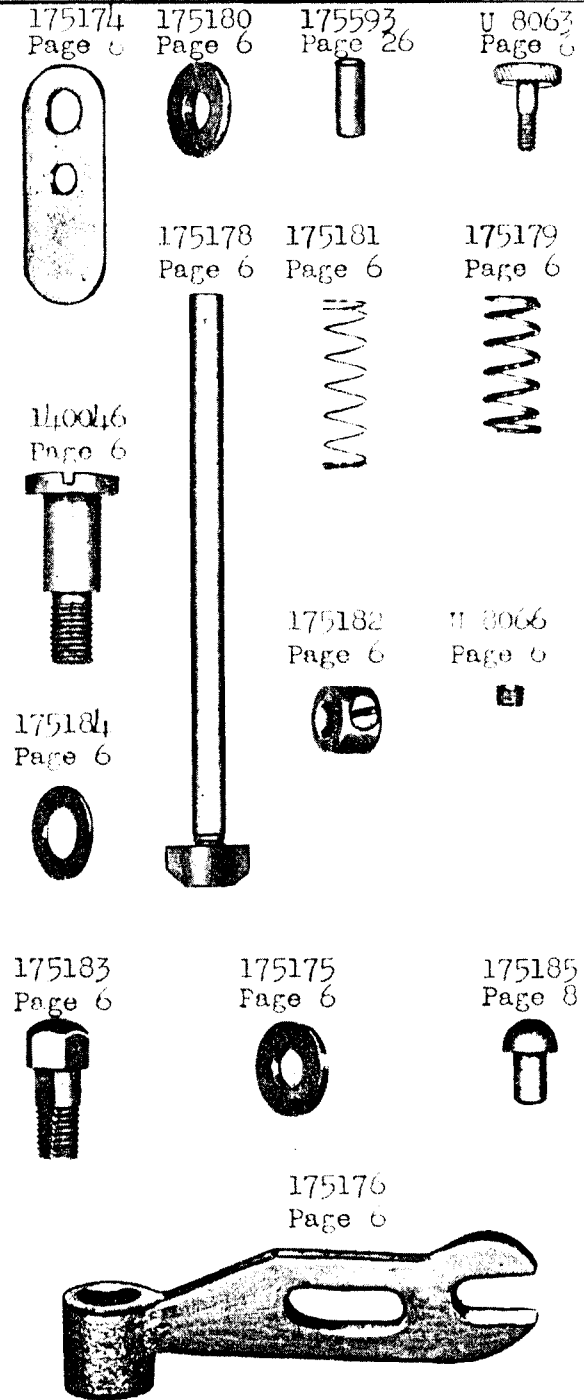
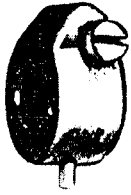
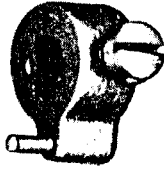


PLATE U 21924 - FULL SIZE

175189  
Page 6



175191  
Page 6



175187  
Page 6



U 8027  
Page 6



175190  
Page 23



175192  
Page 25



175299  
Page 13



175291  
Page 17



175287  
Page 21



175289  
Page 21



U 8716  
Page 19



175285  
Page 25



241  
Page 25



175290  
Page 19

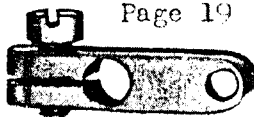


PLATE U 21925 - ONE-HALF SIZE



175282  
Page 13



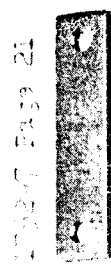
175283  
Page 13



175284  
Page 13



175285  
Page 13



175286  
Page 21

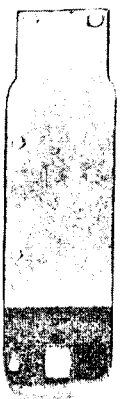
175289  
Page 26



175291  
Page 25



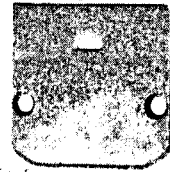
175294  
Page 17



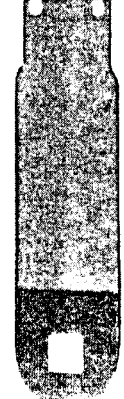
175295  
Page 21



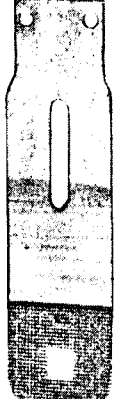
175138  
Page 16



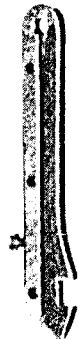
175305  
Page 8



175304  
Page 16



175302  
Page 25



175303  
Page 16

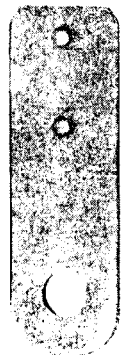


PLATE U 21926 - FULL SIZE

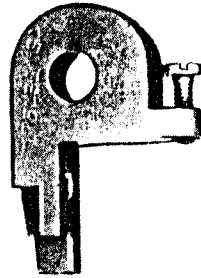
175352  
Page 21



175439  
Page 24



175436  
Page 24



175438  
Page 24



51659  
Page 24



175354  
Page 21



140072  
Page 16



U 8667  
Page 18



U 8669  
Page 18



140071  
Page 24



50365  
Page 25



175437  
Page 24



140069  
Page 17



175590  
Page 26



1620  
Page 17



175357  
Page 16



140070  
Page 17



175407  
Page 26

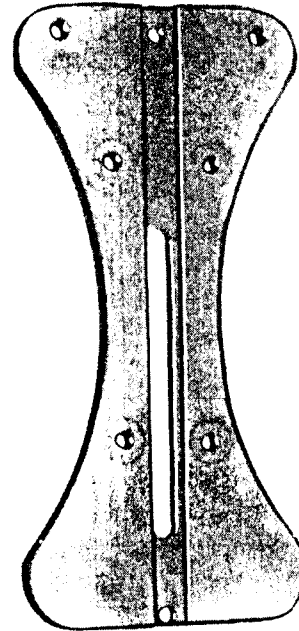


50090  
Page 25

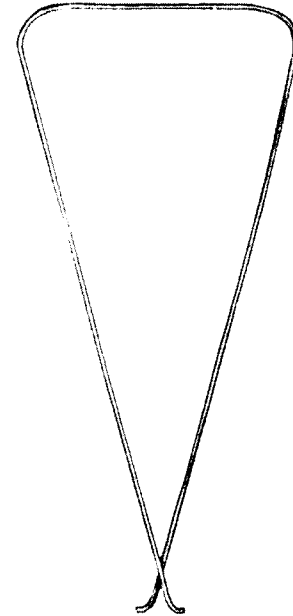


PLATE U 21927 - ONE-HALF SIZE

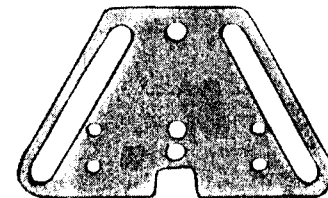
175322  
Page 9



175326  
Page 10



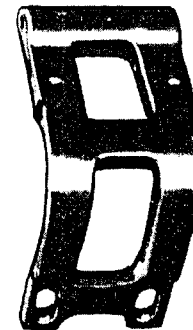
175333  
Page 9



175330  
Page 10



175325  
Page 10



175312 Page 9



175317 Page 9

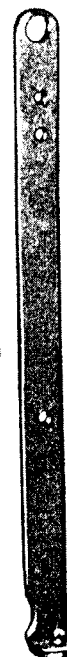


PLATE U 21928 - FULL SIZE

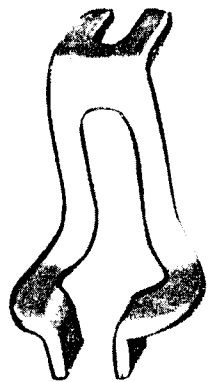
175401  
Page 25



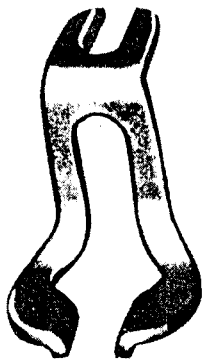
175402  
Page 17



175403  
Page 17



175412  
Page 24



200305  
Page 26



50085  
Page 25



U 8237  
Page 11



U 8628  
Page 17



U 8627  
Page 17



208  
Page 25



225322  
Page 26



201018  
Page 26



201016  
Page 26

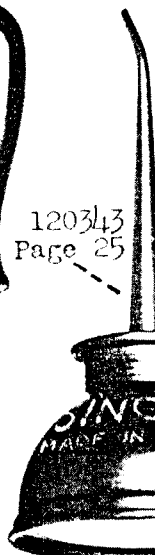


PLATE U 21929 - ONE-HALF SIZE

26026  
Page 25



120343  
Page 25



120342  
Page 25

175197  
Page 11



175198  
Page 11



175195  
Page 11



175194  
Page 25



175193  
Page 12

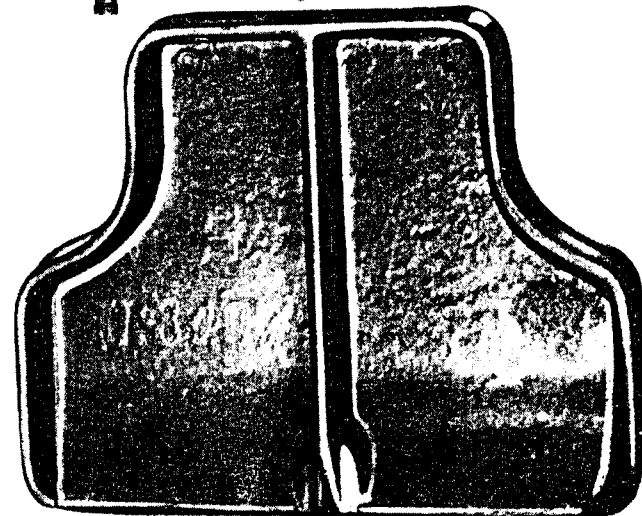
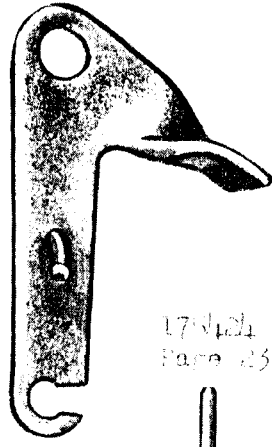


PLATE U 21930 - FULL SIZE

175115  
Page 12



175208  
Page 13



175124  
Page 23



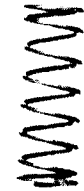
110047  
Page 12



110048  
Page 13



175210  
Page 23



175202  
Page 25



U 8465  
Page 13



175536  
Page 12

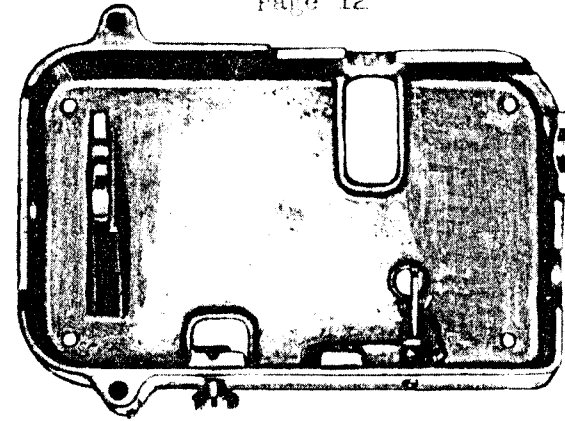


U 8466  
Page 13

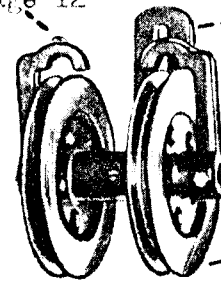


PLATE U 21931 - ONE-FOURTH SIZE

175200  
Page 12



175220  
Page 12



175228  
Page 25

175225  
Page 12

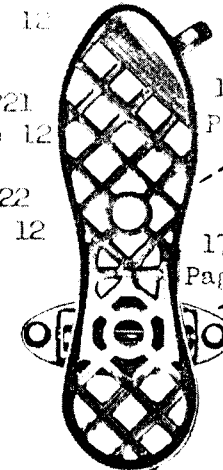
175221  
Page 12

175222  
Page 12

175219  
Page 12

175216  
Page 25

175218  
Page 25



175227  
Page 25



175224  
Page 12



175217  
Page 25

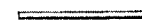
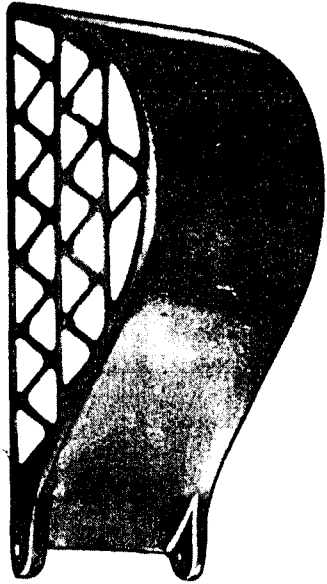
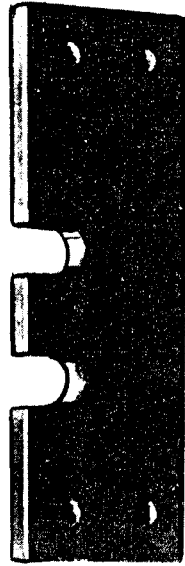


PLATE U 21932 - ONE-FOURTH SIZE

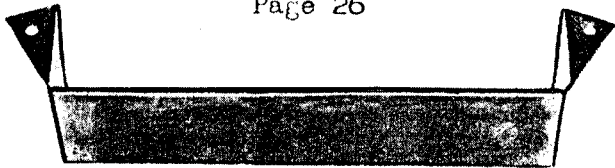
175537  
Page 26



175539  
Page 26



175538  
Page 26



175543  
Page 26



175542  
Page 26

175541  
Page 26

PLATE U 21933 - ONE-FOURTH SIZE

225260  
Page 26

225321  
Page 26

225391  
Page 26

225390  
Page 26

27739  
Page 25



225308  
Page 26

150203  
Page 25

225259  
Page 26

202490  
Page 26

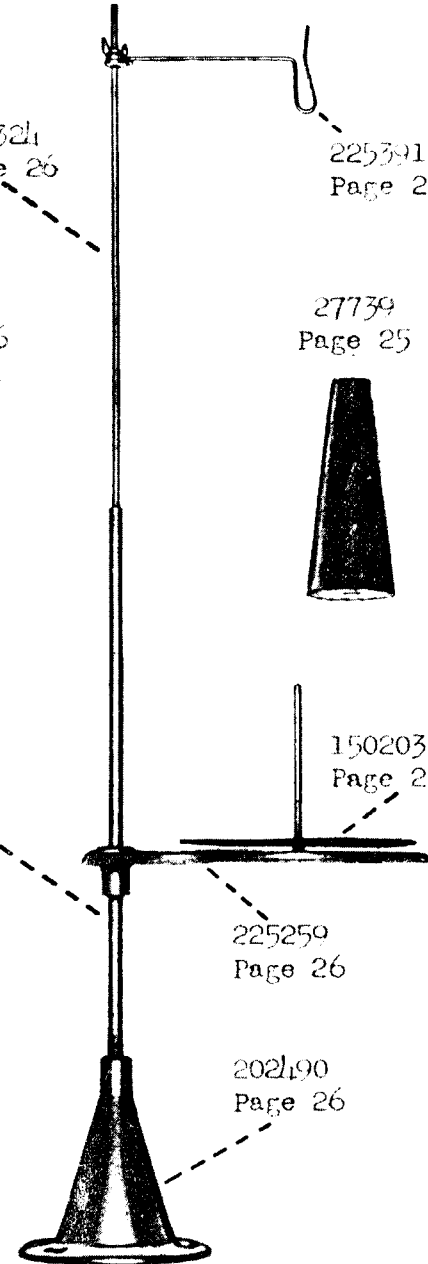
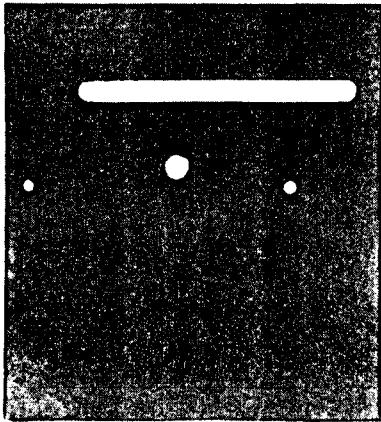
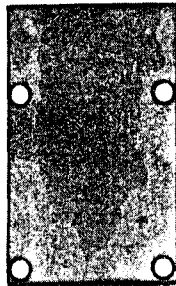


PLATE U 21935 - ONE-HALF SIZE

175443  
Page 20



175020  
Page 12



175259  
Page 22



175246  
Page 20



175247  
Page 20



175252  
Page 21



175256  
Page 22



175253 175254 175257 175258  
Page 21 Page 21 Page 22 Page 21

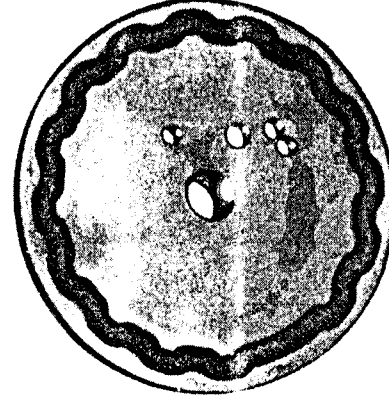


175531  
Page 26

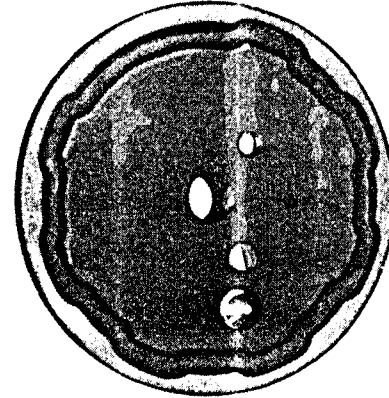


PLATE U 21936 - ONE-HALF SIZE

U 8686  
Page 19



U 8708  
Page 21



U 8705  
Page 21

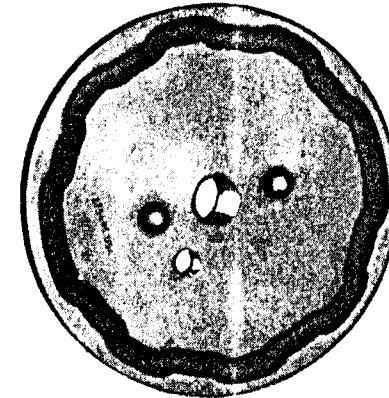
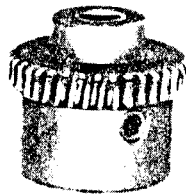
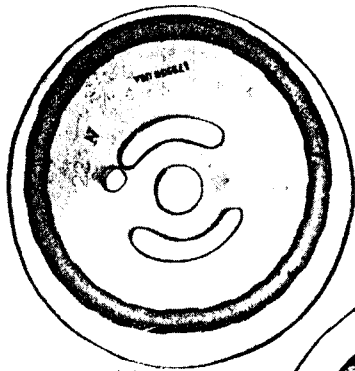
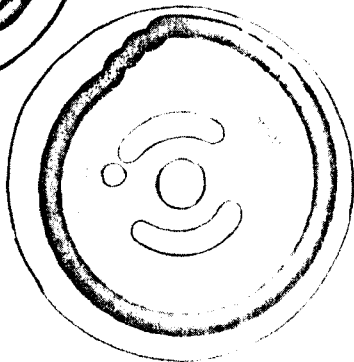


PLATE U 21937 - ONE-HALF SIZE

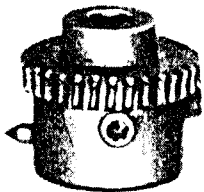
175558  
Page 17



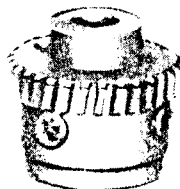
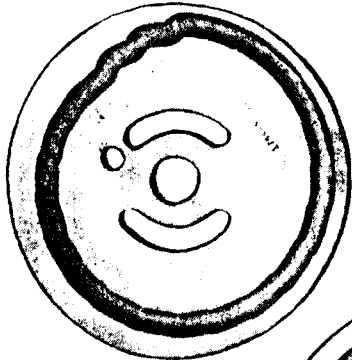
175559  
Page 17



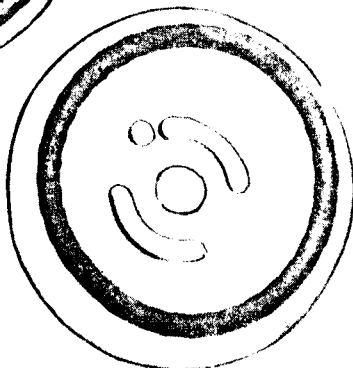
175565



175585  
Page 21



175586  
Page 21



175647  
Page 21



PLATE U 21938 - ONE-HALF SIZE

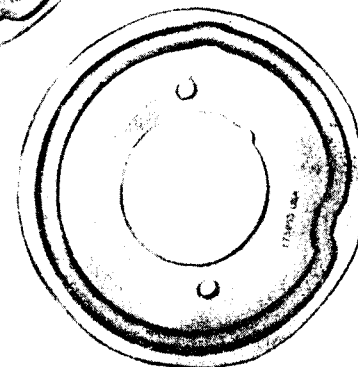
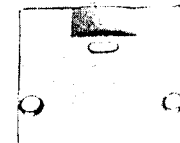
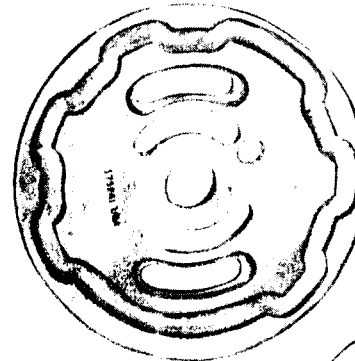
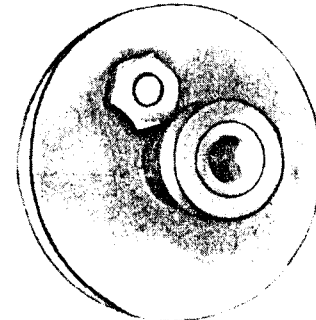
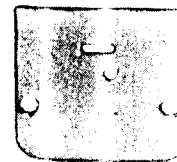
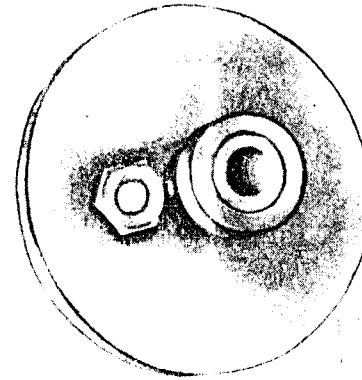
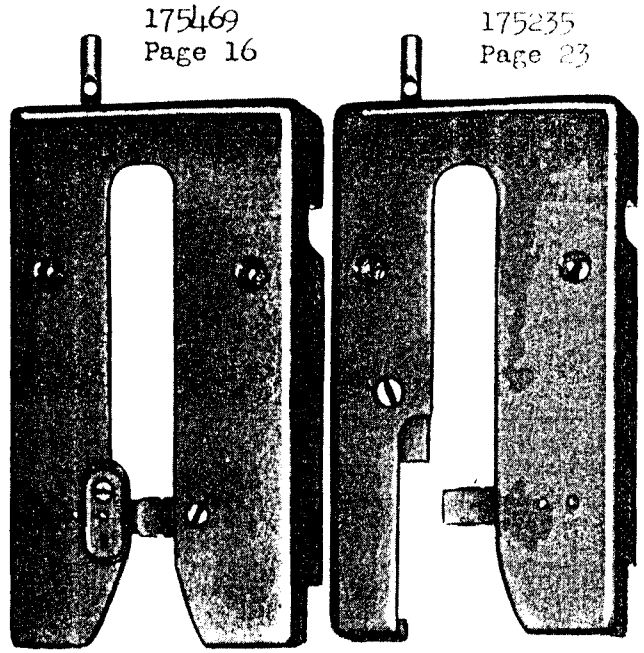


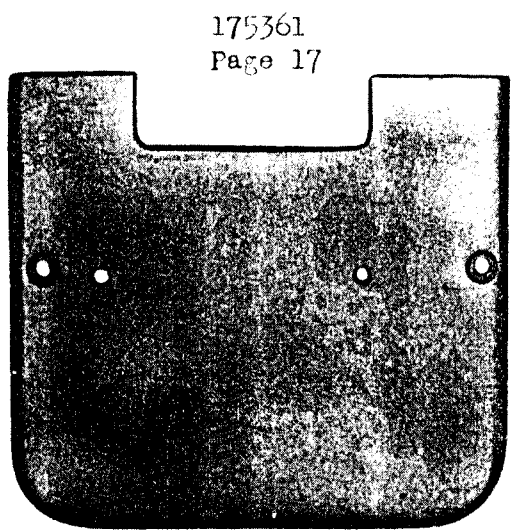


PLATE U 21939 - ONE-HALF SIZE



175469  
Page 16

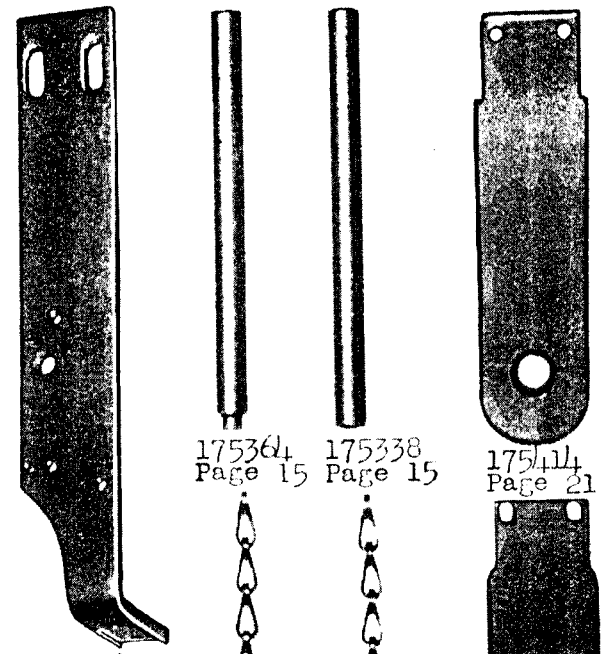
175235  
Page 23



175361  
Page 17

PLATE U 21940 - ONE-HALF SIZE

175362 Page 14    175339 Page 10    175365 Page 15    175356 Page 16

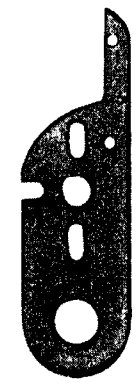


175364  
Page 15

175338  
Page 15

175414  
Page 21

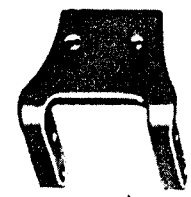
175417  
Page 21



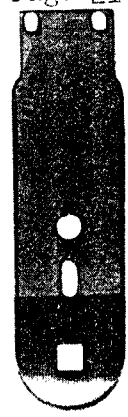
175367  
Page 14



175363  
Page 16



175487  
Page 16



175578  
Page 23

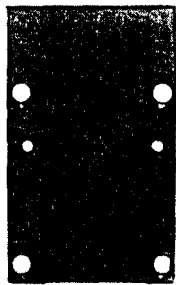


PLATE U 21941 - ONE-HALF SIZE

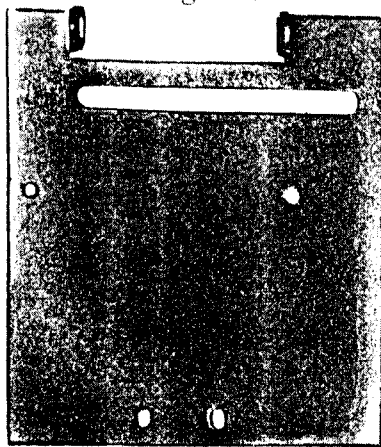
175268  
Page 22



175233  
Page 21



175245  
Page 22



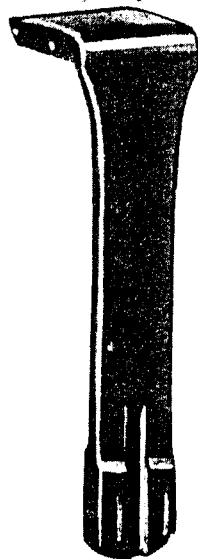
175244  
Page 23



175273  
Page 22



175226  
Page 23



175266  
Page 21

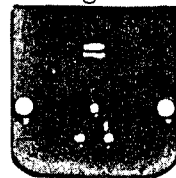


PLATE U 21942 - ONE-HALF SIZE

175475  
Page 18



175480 Page 13



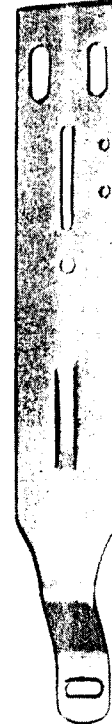
175436  
Page 20



175379 Page 25



175488  
Page 20



175474  
Page 18



175248 Page 22



175371  
Page 18



175451  
Page 20



175476  
Page 18

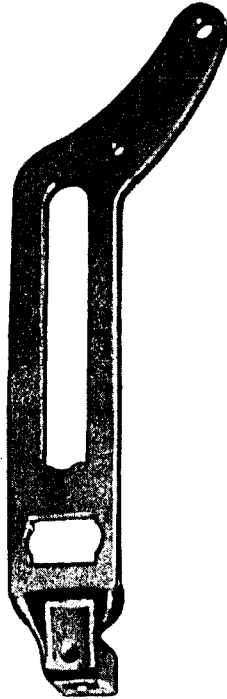


175449 Page 19



PLATE U 21943 - ONE-HALF SIZE

U 8692  
Page 19



175506 175396  
Page 17 Page 17



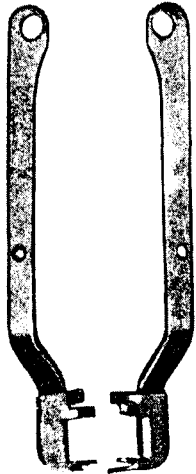
175441  
Page 19



175458  
Page 19



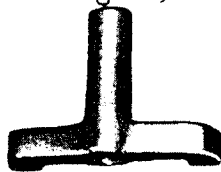
175463 175465  
Page 19 Page 19



175442  
Page 19



175455  
Page 19

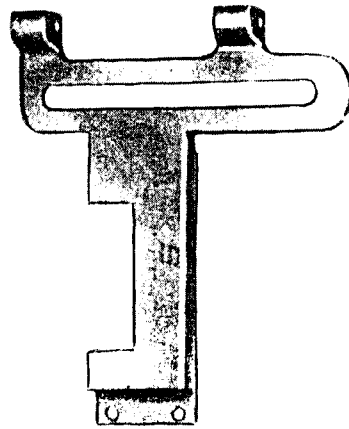


175453  
Page 19

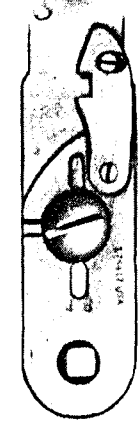


PLATE U 21944 - ONE-HALF SIZE

175505  
Page 26



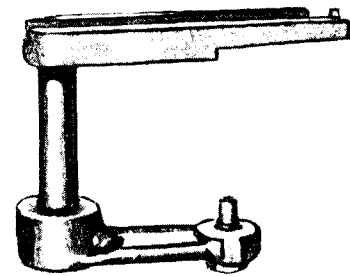
175415  
Page 17



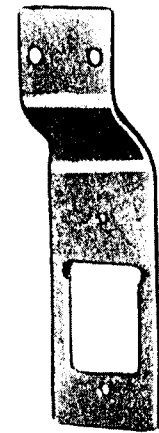
175577  
Page 23



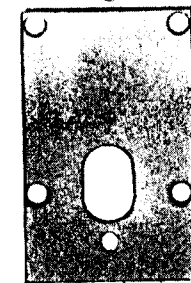
175523  
Page 17



175503  
Page 17



175410  
Page 17



175478  
Page 18



PLATE U 21945 - FULL SIZE

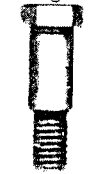
175527  
Page 19



175459  
Page 19



175074  
Page 19



175460  
Page 19



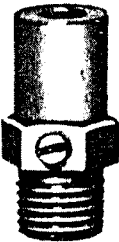
175461  
Page 19



175509  
Page 19



175452  
Page 20



175456  
Page 20



175450  
Page 20



175454  
Page 20



175508  
Page 20



175457  
Page 20



175534  
Page 26



175514  
Page 26



175250  
Page 22



175444  
Page 20

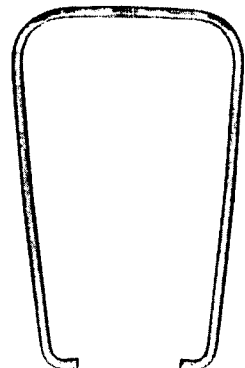


PLATE U 21946 - FULL SIZE

175457  
Page 20



175459  
Page 20



175460  
Page 20



175461  
Page 20



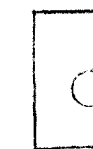
175450  
Page 20



175512  
Page 26



175454  
Page 20



175456  
Page 20



175475  
Page 20



175454  
Page 20



175074  
Page 19



175242  
Page 24



175230  
Page 18



175471  
Page 26



175472  
Page 18



51697  
Page 24



175074  
Page 19

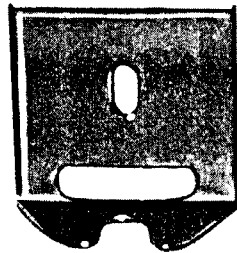


175074  
Page 19

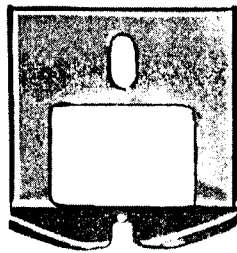


PLATE U 21947 - FULL SIZE

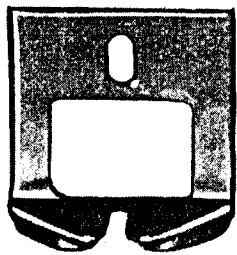
175498  
Page 17



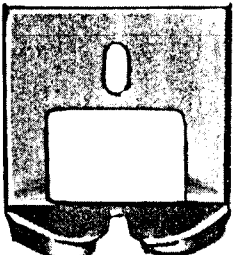
175500  
Page 17



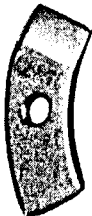
175510  
Page 17



175519  
Page 17



175479  
Page 19



U 8597  
Page 16



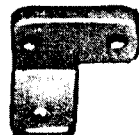
U 8601  
Page 16



U 8604  
Page 17



U 8651  
Page 18



175493  
Page 16



175490  
Page 16



175492  
Page 16

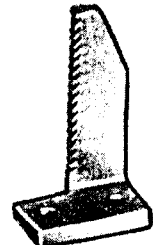


PLATE U 21948 - FULL SIZE

175545  
Page 21



175271  
Page 22



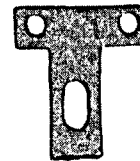
U40054  
Page 22



175274  
Page 22



175251  
Page 21



175279  
Page 22



U40056  
Page 22



U40055  
Page 22



175267  
Page 22



175281  
Page 21



175280  
Page 22



U40053  
Page 22



175272  
Page 22



175395  
Page 22



U1924  
Page 22



175275  
Page 22

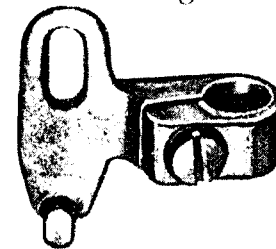
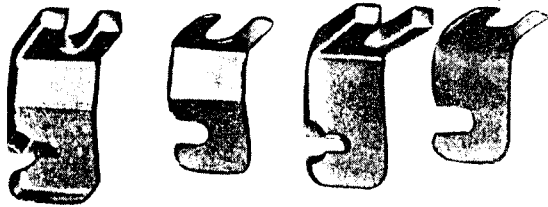
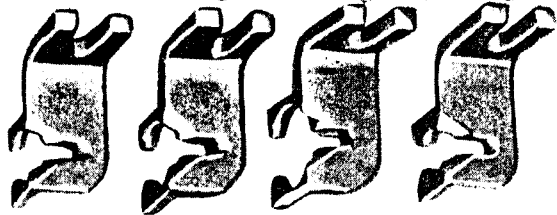


PLATE U 21949 - FULL SIZE

175383 Page 15    175394 Page 15    175371 Page 14    175372 Page 14

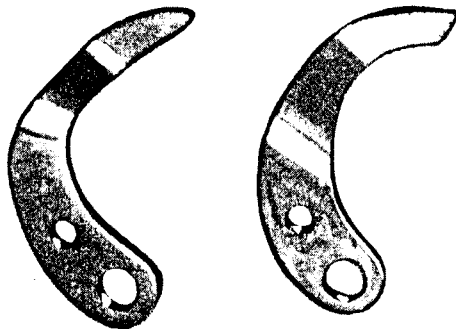


175393 Page 15    175398 Page 15    175399 Page 15    175392 Page 15



175366 Page 14

175391 Page 15



175390 Page 15    U 8537 Page 15

U 8850 Page 22

U 8827 Page 22



U 40066 Page 15

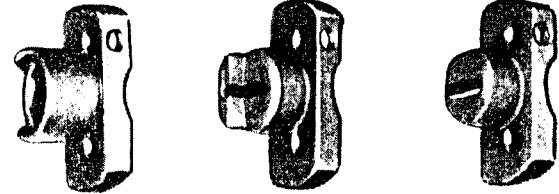
175137 Page 15

U 8557 Page 15

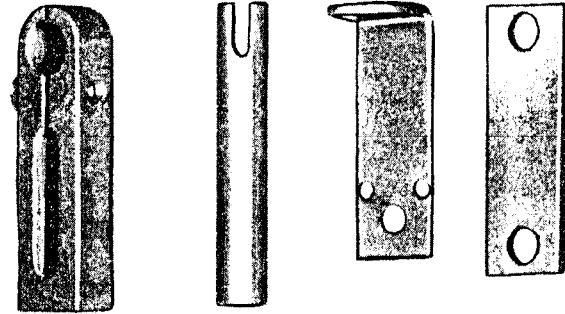


PLATE U 21950 - FULL SIZE

175380 Page 15    175376 Page 15    175377 Page 15



175381 Page 15    175387 Page 15    175321 Page 10    175328 Page 10



175331 Page 10

U 8508 Page 14

175327 Page 10

U 8504 Page 15



690 Page 10

U 40067 Page 15

U 8513 Page 15



U 8505 Page 11

U 8507 Page 11

U 8512 Page 11

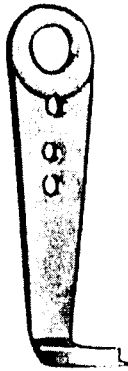
U 8511 Page 11

U 8514 Page 15

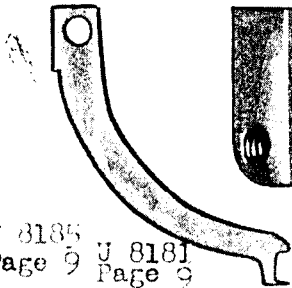


PLATE U 21951 - FULL SIZE

175310  
Page 9



175334  
Page 9



U 8185  
Page 9



175314  
Page 9



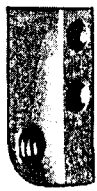
175477  
Page 6



175315  
Page 9



175320  
Page 10



175319  
Page 9



175329  
Page 10



140060  
Page 10



175332  
Page 9



175313  
Page 9



140057  
Page 9



11680  
Page 10



175335  
Page 9



140053  
Page 10



175318  
Page 9



57125  
Page 10

