

**SINGER**  
17W13

# LIST OF PARTS



## MACHINE No. 17w13

---

THE SINGER MANUFACTURING COMPANY

## INDEX

---

	PAGE
ACCESSORIES .....	18
BOBBIN WINDER .....	18
EYELET PUNCHES .....	19
KNEE LIFTER .....	19
MACHINE No. 17w13 .....	7
NEEDLE PLATE AND THROAT PLATE SPURS .....	20
NUMERICAL LIST OF PARTS .....	23
OBSOLETE PARTS .....	21
PRESSER FEET .....	20

# Instructions for Ordering

In ordering from this list, use **ONLY** the **PART** number in the **FIRST** column.

The number stamped on a Sewing Machine Part is the number of the Single Part only, except when the part includes Set Screws, Clamping Screws, Studs and Rollers Spun on, Small Wires riveted, or Parts soldered together, etc., which it is necessary to furnish in combination.

Every combination of parts sent out has its specific number which, although not stamped on Parts (except in above cases) must be used when ordering the combination.

Each number always indicates the **SAME PART** in whatever list it appears, or for whatever Machine.

The letters after some of the numbers indicate the style of finish only, as follows:

- A. Hardened, Polished and Plated.
- B. Polished and Plated.
- C. Hardened only.
- D. Polished only.
- E. Soft, not polished.
- F. Hardened and Polished.
- H. Blued.

These letters **MUST BE USED** when they appear in the list and **AFTER** the number, as in the list.

In this series

- 200001 to 201500 are Screw Numbers.
- 201501 to 201800 are Nut Numbers.
- 201801 to 202000 are Roller Numbers.
- 202001 and upward are numbers of Machine Parts.

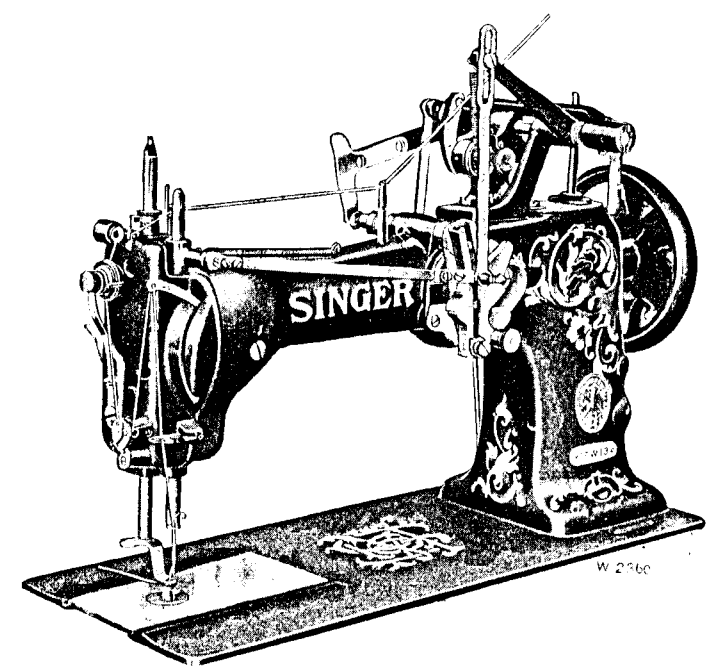
The figures in the second column refer only to the plate in which the illustration of the part is shown and are **NOT TO BE USED** in ordering.

Two or more numbers over a cut indicate that the difference between such parts is not visible in an illustration.

Parts marked with an asterisk (\*) are furnished only when repairs are made at the factory.

## LIST OF PARTS COMPLETE

FOR



## MACHINE No. 17w13

For Making Eyelets of Various Shapes and Sizes,  
 Known as Madeira Work; also Flat Stitch  
 Embroidery.

No.	Plate	Name
*234401	—	Arm with 200439c and 208605 .....
208602	12801	" Cap with 208604 and two 200137H .....
200278H	12311	Arm Cap Screw .....
202248	12802	" " " Washer .....
208603	12801	" " Spool Pin .....
208604	—	" " " " Base with 208603
200137H	12802	" " " " Screw .....
200963E	12311	" Screw (3) .....
202005	12802	" " Washer (3) .....

No.	Plate	Name
208658	10693	Arm Shaft .....
208605	12801	" " Bushing (front) .....
200439c	12311	" " " Position Screw ..
204165	12801	" " Connection with four 200054E (2) .....
200054E	12805	Arm Shaft Connection Screw ....
204174	10693	Balance Wheel, 5½ in. diam. (belt groove 2¼ in. diam.), with 200328c and 200335c .....
200062H	12311	Balance Wheel Adjusting Screw ..
200328c	12311	" " Position Screw ....
200335c	12802	" " Set Screw .....
*234461	—	Bed with 202062, 204245, 204393 and two 200516E .....
202258	12345	Bed Hinge Connection (2) .....
200570E	12311	" " " Screw (4) ....
204178	12802	Bobbin .....
208462	—	" Case with 204181 .....
204181	12802	" " Position Finger .....
204182	12802	" " Tension Spring .....
200598c	12802	" " " " Adjust- ing Screw .....
200592c	12802	Bobbin Case Tension Spring Screw
208463	12802	Bobbin Case complete, Nos. 200592c, 200598c, 204182 and 208462 .....
208656	—	Face Plate with 200366H, 200368H, 202087, 202090, 204185, 204281 and two 200397H .....
200053c	12311	Face Plate Screw (2) .....
204185	12802	" " Thread Guide .....
200397H	10675	" " " " Set Screw
234481	12801	Face Plate complete, Nos. 200286E, 200577H, 201527H, 202088, 204059, 204280, 204934, 206639, 208656 and 234441 .....
234402	12803	Hook (sewing) with 204217 .....
204217	12802	" Bobbin Case Stud .....
204880	10665	" Bracket with 200379c, two 200380c and three 204234 .....
204881	—	Hook Bracket 204880 with 204226c
208610	—	" " 204881 with 204224, 204225, 204229, 204539, two each 204223 and 204231 .....
200379c	10665	Hook Bracket Adjusting Screw (lower) .....
200380c	12319	Hook Bracket Adjusting Screw (upper) .....
204539	10665	Hook Bracket Bobbin Case Stop (hinged) .....

No.	Plate	Name
204223	10665	Hook Bracket Bobbin Case Stop Hinge Pin .....
204224	10665	Hook Bracket Bobbin Case Stop Latch .....
204223	10665	Hook Bracket Bobbin Case Stop Latch Hinge Pin .....
204225	10665	Hook Bracket Bobbin Case Stop Latch Spring .....
200085c	12802	Hook Bracket Screw (lower or upper) (2) .....
234482	12803	Hook Bracket complete, Nos. 208610 and 234402 .....
234403	12803	Hook Driver with 234486 .....
204885	10669	" " Bevel Gear, 25 teeth, with two 200348c .....
200348c	10665	Hook Driver Bevel Gear Set Screw
208246	—	" " Crank .....
204240	12802	" " " 208246 with 200378c, 200662c, 201530E and two 200348c .....
204241	12802	Hook Driver Crank Link .....
200669c	10665	" " " " Stud ....
201530E	10665	" " " " " Nut
200348c	10665	" " " Set Screw (long)
200378c	12311	" " " " (short)
200662c	10665	" " " Screw Stud ...
201530E	10665	" " " " " Nut
234486	—	" " Washer .....
204887	10669	" Driving Bevel Gear, 24 teeth (intermediate) .....
204888	—	Hook Driving Bevel Gear (inter- mediate) Bracket .....
206078	10669	Hook Driving Bevel Gear (inter- mediate) Bracket 204888 with 200772c, 201514E and 204887 ....
200041E	10669	Hook Driving Bevel Gear (inter- mediate) Bracket Screw (2) ....
200772c	10669	Hook Driving Bevel Gear (inter- mediate) Bracket Screw Stud ..
201514E	10669	Hook Driving Bevel Gear (inter- mediate) Bracket Screw Stud Nut .....
204890	12801	Hook Driving Bevel Gear (inter- mediate) Oil Guard .....
200113F	12802	Hook Driving Bevel Gear (inter- mediate) Oil Guard Screw (2) ..
204886	10669	Hook Driving Bevel Gear Shaft, 25 teeth .....
204393	12802	Hook Driving Bevel Gear Shaft Bushings .....

No.	Plate	Name
204891	10693	Hook Driving Shaft .....
204245	12801	" " " Bearing .....
202126	12802	" " " " Position Pin .....
200516E	12311	Hook Driving Shaft Bearing Screw
204246	12802	" " " Collar with two 200383c .....
200383c	12311	Hook Driving Shaft Collar Set Screw .....
204201	12805	Hook Driving Shaft Crank with 200335c, 200431c, 200669c and 201530E .....
200431c	12805	Hook Driving Shaft Crank Position Screw .....
200335c	12802	Hook Driving Shaft Crank Set Screw .....
204226	12802	Hook Race, .156 in. thick, 1.906 in. diameter .....
204229	10665	Hook Race Cap (iron) .....
204230	10665	" " " Spring .....
204231	10665	" " " " 204230 with 200792E .....
200792E	10665	Hook Race Cap Spring Screw ....
204234	10665	" " Position Pin .....
208613	---	Needle Bar (hollow) .....
208615	12801	" " 208613 with 200125E, 200175D and 208640 .....
*206360	---	Needle Bar Connecting Ball Stud with 200086c .....
200086c	12805	Needle Bar Connecting Ball Stud Pinch Screw .....
208641	---	Needle Bar Connecting Link with 206353 and two 200079c .....
206354	12805	Needle Bar Connecting Link 208641 with 206360 .....
200744c	12805	Needle Bar Connecting Link Ball Screw Stud .....
*206352	---	Needle Bar Connecting Link Ball Screw Stud Cap .....
201013c	12805	Needle Bar Connecting Link Ball Screw Stud Cap Screw .....
201522E	12805	Needle Bar Connecting Link Ball Screw Stud Nut .....
*206353	---	Needle Bar Connecting Link Cap
200079c	12311	" " " " " " Screw .....
208616	12807	Needle Bar Frame .....
234487	12804	" " " Cam Gear, 36 teeth .....

No.	Plate	Name
234488	12804	Needle Bar Frame Cam Gear Cover
234489	---	" " " " " 234488 with 200062H and 234487..
200571B	12805	Needle Bar Frame Cam Gear Cover Screw (3) .....
208568	12814	Needle Bar Thumb Frame Cam Gear Oil Leader .....
202254	---	Needle Bar Frame Cam Gear Oil- ing Wick .....
200062H	12311	Needle Bar Frame Cam Gear Stop Screw .....
206431	12805	Needle Bar Frame Center (lower)
200363c	12805	" " " " " Set Screw .....
206430	12805	Needle Bar Frame Center (upper)
200347c	12805	" " " " " Set Screw .....
234490	12805	Needle Bar Frame Driving Bevel Pinion, 18 teeth, with two 200374c
200374c	12805	Needle Bar Frame Driving Bevel Pinion Set Screw .....
208618	---	Needle Bar Frame Pitman with 200741c, 201531E, 204921 and two 200110B .....
200741c	12805	Needle Bar Frame Pitman Ball Screw .....
*204921	---	Needle Bar Frame Pitman Ball Screw Cap .....
200110B	12805	Needle Bar Frame Pitman Ball Screw Cap Screw .....
201531E	12805	Needle Bar Frame Pitman Ball Screw Nut .....
204922	12805	Needle Bar Frame Pitman Con- nection (adjustable) .....
234483	---	Needle Bar Frame Pitman Con- nection 204922 with 204924, 208618 and two 200110B .....
234405	12805	Needle Bar Frame Pitman Con- nection (adjustable) Bearing .....
204924	12805	Needle Bar Frame Pitman Con- nection Clamp Washer .....
200110B	12805	Needle Bar Frame Pitman Con- nection Clamp Washer Screw .....
234406	12807	Needle Bar Frame Regulator .....
234491	12806	" " " " Driver with 200376c, 201816 and 234492
203244	12806	Needle Bar Frame Regulator Driver Collar with two 200393c .....

No.	Plate	Name
200393c	12806	Needle Bar Frame Regulator Driver Collar Set Screw .....
201816	12806	Needle Bar Frame Regulator Driver Roller .....
234492	12806	Needle Bar Frame Regulator Driver Roller Stud (eccentric) .....
200376c	12806	Needle Bar Frame Regulator Driver Roller Stud Set Screw .....
234409	12806	Needle Bar Frame Regulator Index Plate .....
200474D	12806	Needle Bar Frame Regulator Index Plate Adjusting Thumb Screw ..
206505	12806	Needle Bar Frame Regulator Index Plate Slide Block .....
201251E	12806	Needle Bar Frame Regulator Position Screw Stud .....
222705	12806	Needle Bar Frame Regulator Position Screw Stud Spring .....
1538D	12806	Needle Bar Frame Regulator Position Screw Stud Thumb Nut ....
234410	12806	Needle Bar Frame Regulator Slide
201644B	12806	“ “ “ “ “ “ Adjusting Nut .....
200174D	12806	Needle Bar Frame Regulator Slide Adjusting Nut Stop Screw .....
226163	12806	Needle Bar Frame Regulator Slide Adjusting Nut Washer.....
234411	12806	Needle Bar Frame Regulator Slide Index Plate .....
234412	12808	Needle Bar Frame Regulator Slide Link with 204190 .....
234413	12808	Needle Bar Frame Regulator Slide Link Lever with 200383c, 200441c and 204189 .....
200441c	12808	Needle Bar Frame Regulator Slide Link Lever Position Screw .....
200383c	12311	Needle Bar Frame Regulator Slide Link Lever Set Screw .....
234414	12808	Needle Bar Frame Regulator Slide Link Lever Shaft .....
222707	10694	Needle Bar Frame Regulator Slide Link Lever Shaft Bracket .....
200019E	12808	Needle Bar Frame Regulator Slide Link Lever Shaft Bracket Screw (2) .....
222708	12809	Needle Bar Frame Regulator Slide Link Lever Shaft Driving Lever with 200383c and 200441c .....

No.	Plate	Name
222709	10694	Needle Bar Frame Regulator Slide Link Lever Shaft Driving Lever 222708 with 222713 and two 334D
200441c	12808	Needle Bar Frame Regulator Slide Link Lever Shaft Driving Lever Position Screw .....
200383c	12311	Needle Bar Frame Regulator Slide Link Lever Shaft Driving Lever Set Screw .....
234415	12809	Needle Bar Frame Regulator Slide Link Lever Shaft Spring .....
214361	12809	Needle Bar Frame Regulator Slide Link Lever Spring .....
204190	12809	Needle Bar Frame Regulator Slide Link Lever Spring Hook, for 234412 .....
204189	12809	Needle Bar Frame Regulator Slide Link Lever Spring Hook, for 234413 .....
200281D	12809	Needle Bar Frame Regulator Slide Link Screw .....
208631	12807	Needle Bar Frame Regulator Slide Operating Rod .....
201520H	12809	Needle Bar Frame Regulator Slide Operating Rod Adjusting Nut (lower or upper) .....
215353	12809	Needle Bar Frame Regulator Slide Operating Rod Bracket with 200527c and 201531E .....
208633	10693	Needle Bar Frame Regulator Slide Operating Rod Bracket Connection with 208635 .....
200224H	12809	Needle Bar Frame Regulator Slide Operating Rod Bracket Connection Hinge Screw .....
208634	12809	Needle Bar Frame Regulator Slide Operating Rod Bracket Connection Link .....
200273D	12809	Needle Bar Frame Regulator Slide Operating Rod Bracket Connection Link Hinge Screw .....
208635	10669	Needle Bar Frame Regulator Slide Operating Rod Bracket Connection Link Stud .....
202302	12805	Needle Bar Frame Regulator Slide Operating Rod Bracket Connection Link Stud Cotter Pin .....
200536c	12809	Needle Bar Frame Regulator Slide Operating Rod Bracket Connection Stop Screw .....

No.	Plate	Name
208637	12807	Needle Bar Frame Regulator Slide Operating Rod Bracket Connection Stop Screw Bracket with two each 200536c and 201521c .....
200053c	12311	Needle Bar Frame Regulator Slide Operating Rod Bracket Connection Stop Screw Bracket Screw ..
201521c	12809	Needle Bar Frame Regulator Slide Operating Rod Bracket Connection Stop Screw Nut .....
200239H	12809	Needle Bar Frame Regulator Slide Operating Rod Bracket Hinge Screw .....
201531E	12805	Needle Bar Frame Regulator Slide Operating Rod Bracket Hinge Screw Nut .....
200527c	12809	Needle Bar Frame Regulator Slide Operating Rod Set Screw .....
201531E	12805	Needle Bar Frame Regulator Slide Operating Rod Set Screw Nut ..
208638	12809	Needle Bar Frame Regulator Slide Operating Rod Spring .....
208639	—	Needle Bar Frame Regulator Slide Operating Rod Spring Holding Eyelet (lower or upper) .....
203060	12809	Needle Bar Frame Regulator Slide Operating Rod Spring Holding Eyelet Hook .....
234418	12809	Needle Bar Frame Regulator Spring
234419	12809	" " " " Stop...
234420	12811	" " " " " Collar with 200380c .....
200380c	12319	Needle Bar Frame Regulator Stop Collar Set Screw .....
200078E	12811	Needle Bar Frame Regulator Stop Screw (2) .....
234421	12811	Needle Bar Frame Regulator Switching Plunger .....
234422	12807	Needle Bar Frame Regulator Switching Plunger Lever .....
234423	12811	Needle Bar Frame Regulator Switching Plunger Lever Operating Lever .....
234424	12811	Needle Bar Frame Regulator Switching Plunger Lever Operating Lever Friction Plate .....
200174D	12806	Needle Bar Frame Regulator Switching Plunger Lever Operating Lever Friction Plate Screw .....

No.	Plate	Name
200690c	12811	Needle Bar Frame Regulator Switching Plunger Lever Operating Lever Hinge Screw .....
234425	12811	Needle Bar Frame Regulator Switching Plunger Lever Plate .....
200160B	12811	Needle Bar Frame Regulator Switching Plunger Lever Plate Screw (2)
234426	12811	Needle Bar Frame Regulator Switching Plunger Spring .....
234427	12811	Needle Bar Frame Spring .....
203060	12809	" " " " Hook (2)
208640	12811	" " Thread Guide .....
200175D	12811	" " " " Set Screw
200125F	12811	" Set Screw .....
234429	12807	Presser Bar (hollow) .....
234430	12810	" " Clamping Rod .....
201644B	12806	" " " " Nut ..
204252	12811	" " Lifter .....
200550c	12311	" " " Hinge Screw ....
234431	12811	" " Lifting Bracket .....
204254	12812	" " " " Position Guide .....
200362c	12311	Presser Bar Lifting Bracket Position Guide Set Screw .....
204327	—	Presser Bar Packing Washer (felt)
200504E	12812	" " Screw Bushing (lower)
234432	12812	" " Spring .....
200491B	12812	" " Thumb Screw (pressure regulating) .....
234504	12812	Presser Foot, for eyelets $\frac{3}{8}$ in. diameter .....
208674	12810	Take-up Cam with 200335c, 200383c, 200430c, 200744c, 201522E, 206352 and two 201013c .....
200430c	12311	Take-up Cam Position Screw ....
200383c	12311	" " " " Check Screw .....
200335c	12802	Take-up Cam Set Screw .....
208675	12810	Take-up Cam complete, Nos. 206354 and 208674 .....
204262	12812	Take-up Lever .....
206556	—	" " 204262 with 204263 ..
204263	12812	" " Bearing with 204264
204264	12812	" " " Position Pin ..
200042F	12311	" " " Screw .....
201816	12806	" " Roller .....
204266	12812	Take-up Lever complete, Nos. 200042F, 201816 and 206556 .....

No.	Plate	Name
202402	10675	Tension Disc .....
202090	10675	" " Position Pin .....
234441	12812	" Release Lever .....
200286F	12812	" " " Hinge Screw .....
201527H	10669	" " " " " " Nut .....
204934	12812	Tension Release Lever Hinge Screw Washer .....
200650F	12812	Tension Release Lever Switch Screw Stud .....
201525E	12812	Tension Release Lever Switch Screw Stud Nut .....
202407	10881	Tension Spring .....
200632B	10675	" Stud .....
200397H	10675	" " Set Screw .....
201572B	10881	" Thumb Nut .....
204271	10675	" Washer .....
206639	10675	Tension complete, Nos. 200632B, 201572B, 202407, 204271 and two 202402 .....
204274	10675	Thread Controller Plate .....
200577H	12311	" " " Screw ....
202098	10675	" " Roller .....
204275	10675	" " " Guard .....
202084	10675	" " " " Washer .....
200300C	10675	" " " Screw .....
204276	10675	" " Spring .....
204333	10675	" " " Guard .....
200581H	10675	" " " Screw .....
202087	10675	" " " Stop .....
202088	10675	" " " Stud with 204925 .....
200366H	10675	Thread Controller Spring Stud Set Screw .....
204925	10675	Thread Controller Spring Stud Washer .....
205987	10675	Thread Controller complete, Nos. 200300C, 200581H, 202084, 202098, 204274, 204275 and 204333 .....
204280	10675	Thread Controller and Spring complete, Nos. 204276 and 205987 ..
202412	12813	Thread Guide .....
204459	12813	" " .....
204281	10675	" Retainer Guide Wire .....
202091	10675	" " Sleeve .....
202092	10675	" " Spring .....
204058	10675	" " Stud .....
200368H	10675	" " " Set Screw .....

No.	Plate	Name
204059	10675	Thread Retainer complete, Nos. 202091, 202092 and 204058 .....
234442	12810	Throat Plate .....
234443	12813	" " Latch .....
234444	12813	" " " Friction Washer .....
200318H	12813	" " " Screw .....
202062	12813	" " Position Pin .....
234512	12813	" " Spur, for eyelete $\frac{3}{16}$ in. diameter .....
234452	12813	Throat Plate Spur Locking Slide .....
200321D	12813	" " " " " " Screw (2) .....
2102	10881	Variable Tension Disc .....
222712	10694	" " " Spring .....
222713	12813	" " Releasing Plate .....
334D	10694	" " " " " " Screw .....
201046E	10694	Variable Tension Stud .....
222714	10694	" " " Bushing .....
200355H	12319	" " " " " Set Screw .....
222715	10694	Variable Tension Stud Spring .....
222716	10694	" " " " " Plate .....
329D	10694	" " " " " " Screw .....
201620D	10694	Variable Tension Stud Thumb Nut .....
222717	10694	" " Thread Guide ....
200132D	10694	" " " " " Screw .....
234494	—	Throat Plate complete, Nos. 200318H, 234442 to 234444, 234452 and two 200321D .....



## ACCESSORIES

No.	Plate	Name
204178	12802	Bobbin (5) .....
*225482	----	" Case Screw Driver Blade ..
*225483	----	" " " " Handle ..
225497	12345	Bobbin Case Screw Driver complete, Nos. 225482 and 225483 ..
130 x 25	---	Needles, six, size 9 .....
228166	---	Drip Pan with four wood screws $\frac{1}{2}$ in., No. 5 .....
87561	---	Embroidery Hoop .....
41400	12345	Machine Rest Pin (wood) .....
36578	12345	Oiler with 36579 .....
36579	12345	" Spout, $3\frac{1}{2}$ in. long, with 120117
120117	---	" " Washer .....
*225484	---	Screw Driver Blade .....
*225485	---	" " Handle .....
225498	12345	Screw Driver complete, (7 $\frac{1}{2}$ in. long,) Nos. 225484 and 225485 ..
225554	12345	Wrench (steel) .....

### BOBBIN WINDER

#### Swing Automatic, Right Hand.

*225451	---	Bobbin Holder .....
225453	10882	Frame with 202277 and 225438 ....
225454	10882	" Hinge Pin .....
202277	---	" Oil Packing (wick) .....
225438	10882	" " Well Cap .....
225455	10882	" Spring .....
225456	10882	" " Plunger .....
202473	10883	Pulley with 200380c .....
200380c	12319	" Set Screw .....
*225443	---	Spindle .....
225452	10882	" 225443 with 225451 .....
225444	10882	Stop Latch .....
200056E	10882	" " Screw .....
225458	10882	" " Thumb Lever .....
225459	10882	" " " " Hinge Stud .....
225460	10882	Stop Latch Thumb Lever Joint Stud .....
202478	10882	Stop Latch Trip Lever .....
200299H	10882	" " " " Hinge Screw

No.	Plate	Name
225461	10881	Tension Bracket with 201499B ....
200082D	10881	" " Screw .....
202104	10881	" " " Washer .....
2102	10881	" Disc .....
202407	10881	" Spring .....
201499B	10881	" Stud .....
201572B	10881	" " Thumb Nut .....
225462	10881	Bobbin Winder Tension Bracket complete, Nos. 201572B, 202407, 225461 and two 2102 .....
225433	10883	Bobbin Winder and Tension Bracket Base .....
225436	10883	Universal Bobbin Winder complete, Nos. 200056E, 200082D, 200299H, 202104, 202473, 202478, 225433, 225444, 225452 to 225456, 225458 to 225460, 225462 and two wood screws $\frac{3}{4}$ in., No. 13, R.H.B. ....

### EYELET PUNCHES

234468	---	Eyelet Piercer with 200473B .....
234469	---	" " Holder .....
200473B	12805	" " Thumb Screw .....
234470	---	Eyelet Piercer (adjustable), for eyelets from $\frac{5}{16}$ to $\frac{1}{4}$ in. diam., complete, Nos. 234468 and 234469
234462	12813	Eyelet Punch, for eyelets $\frac{5}{16}$ in. diam., heavy material .....
234463	---	Eyelet Punch, for eyelets $\frac{5}{16}$ in. diam., heavy material, and $\frac{7}{16}$ in. diam., light material .....
234464	---	Eyelet Punch, for eyelets $\frac{5}{16}$ in. diam., heavy material, and $\frac{7}{16}$ in. diam., light material .....
234465	---	Eyelet Punch, for eyelets $\frac{1}{4}$ in. diam., heavy material .....
234466	---	Eyelet Punch, for eyelets $\frac{3}{8}$ in. diam., heavy material .....
234467	---	Eyelet Punch, for eyelets $\frac{3}{8}$ in. diam., light material .....
234484	---	Eyelet Punch Cutting Block (fibre)
234485	---	" " Mallet (wood) .....

### KNEE LIFTER

202450	---	Knee Lifter Rock Lever with 200522c and 200529c .....
--------	-----	---

No.	Plate	Name
202185	—	Knee Lifter Rock Lever 202450 with two each 202451 and 202452 .....
208654	—	Knee Lifter Rock Lever 202185 with 202203 and 208655 .....
202453	10693	Knee Lifter Rock Lever Knee Plate with 200526c .....
202203	—	Knee Lifter Rock Lever Knee Plate 202453 with 202454 .....
202454	10693	Knee Lifter Rock Lever Knee Plate Arm (long) .....
200522c	12319	Knee Lifter Rock Lever Knee Plate Arm Set Screw .....
200526c	12319	Knee Lifter Rock Lever Knee Plate Set Screw .....
202451	10693	Knee Lifter Rock Lever Lug with two wood screws $\frac{3}{4}$ in., No. 13H
202452	12319	Knee Lifter Rock Lever Lug Hinge Pin .....
208655	10693	Knee Lifter Rock Lever Rod with 202456 .....
*202456	—	Knee Lifter Rock Lever Rod Cap or Oil Guard .....
200529c	12319	Knee Lifter Rock Lever Rod Set Screw .....

#### NEEDLE PLATE AND THROAT PLATE SPURS

234428	12813	Needle Plate, 50 elongated needle hole, for needle sizes 16 and 18 ..
234445	—	Throat Plate Spur, for eyelets $\frac{5}{16}$ in. diameter .....
234446	—	Throat Plate Spur, for eyelets $\frac{7}{16}$ in. diameter .....
234513	—	Throat Plate Spur, for eyelets $\frac{1}{4}$ in. diameter .....
234511	—	Throat Plate Spur, for eyelets $\frac{3}{8}$ in., diameter .....

#### PRESSER FEET

234501	—	Presser Foot, for eyelets $\frac{5}{16}$ in. diameter .....
234502	—	Presser Foot, for eyelets $\frac{7}{16}$ in. diameter .....
234505	—	Presser Foot, for eyelets $\frac{1}{4}$ in. diameter .....
234503	—	Presser Foot, for eyelets $\frac{3}{8}$ in. diameter .....

## OBSOLETE PARTS

No.	Plate	Name
202470	12320	Bobbin Winder Base .....
202471	12320	" " Frame .....
202472	12319	" " " Spring .....
202474	12320	" " Spindle .....
202477	12319	" " Stop Latch Thumb Lever .....
202480	12320	Bobbin Winder Spool Holder Base with 200355H and 202484 .....
202481	12320	Bobbin Winder Spool Holder Base Spool Pin .....
202482	12319	Bobbin Winder Spool Holder Tension Disc (lower or upper) .....
202483	12319	Bobbin Winder Spool Holder Tension Disc Spring (brass) .....
202484	12319	Bobbin Winder Spool Holder Tension Disc Thread Guide .....
202485	12320	Bobbin Winder Spool Holder complete, Nos. 200011E, 202480, 202481, 202483, two 202482 and one wood screw 1 in., No. 13 .....
227522	12319	Bobbin Winder Stop Latch .....
227523	12320	Bobbin Winder complete, Nos. 200056E, 200161D, 200221D, 201537H, 202470 to 202474, 202477, 202478, 227522, three 200299H and two round head wood screws 1 in., No. 13 .....
204916	12814	Needle Bar Frame Driving Cam with two 200347c .....
234404	12814	Needle Bar Frame Driving Cam Cover .....
204918	12814	Needle Bar Frame Driving Cam Follower .....
234408	12814	Needle Bar Frame Regulator Driver

PLATE 10665 - FULL SIZE

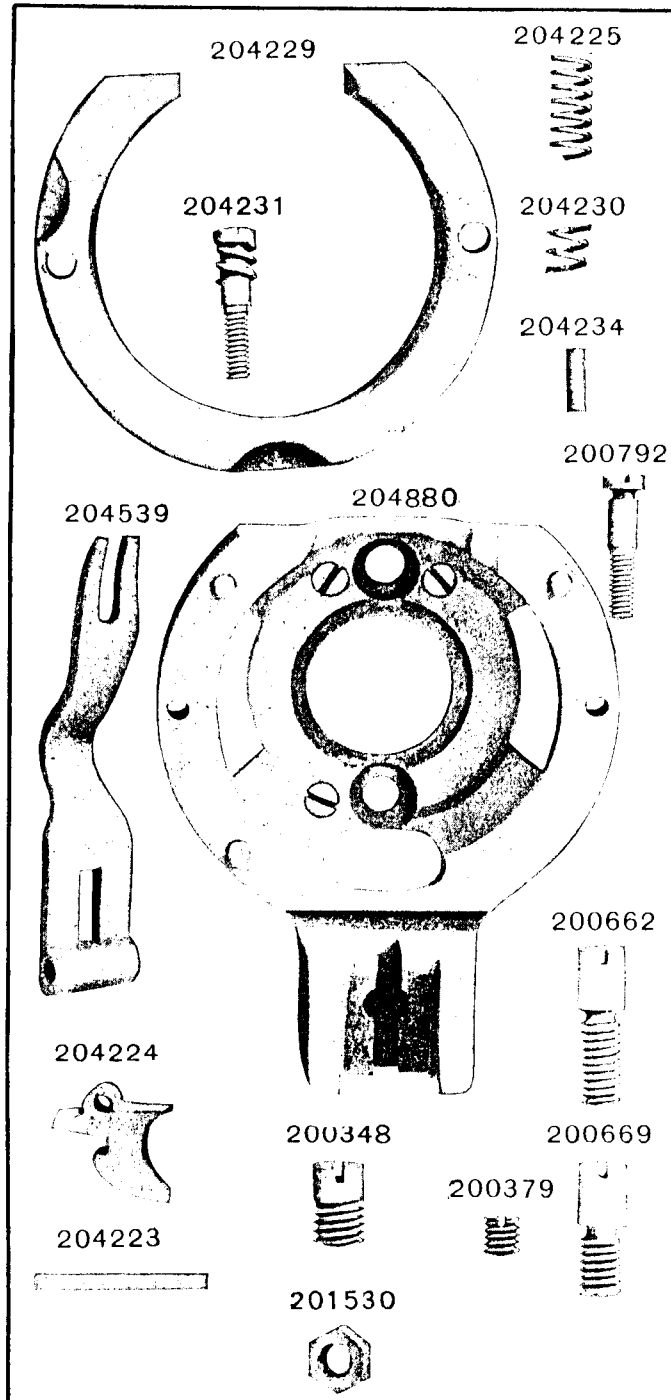


PLATE 10669 - FULL SIZE

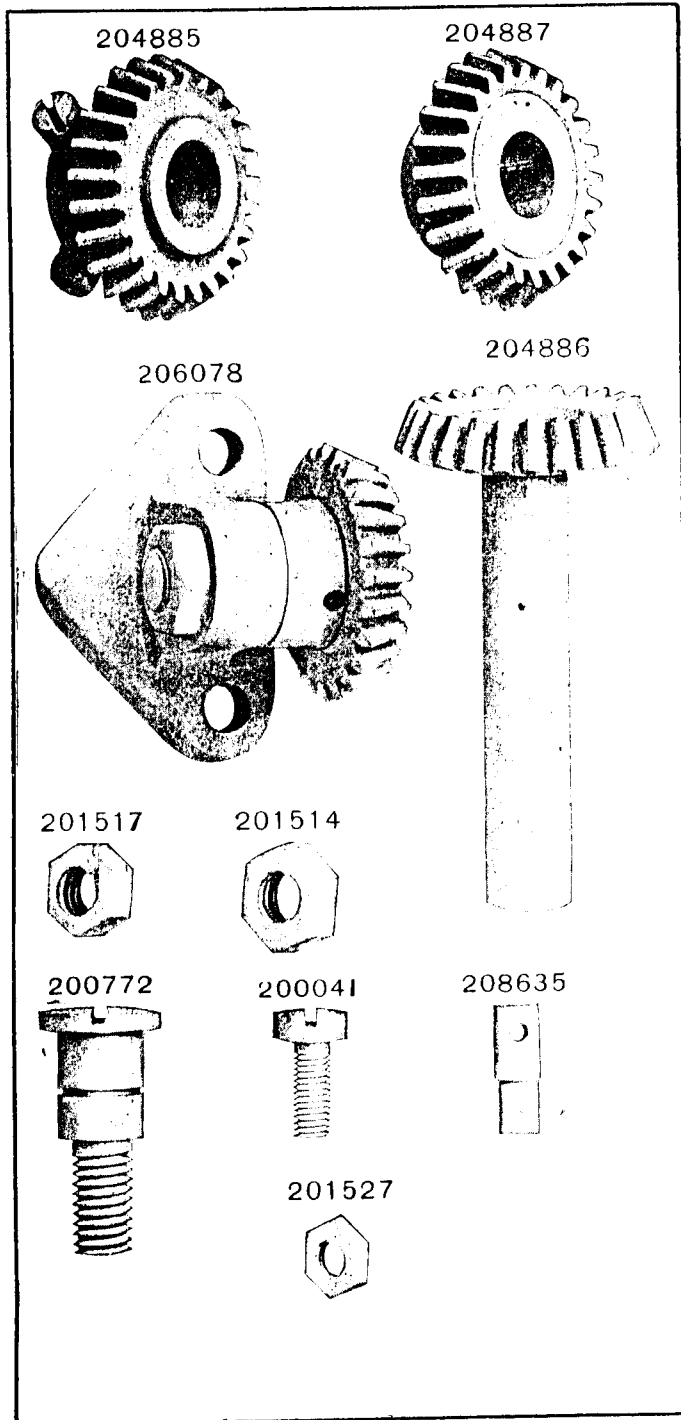


PLATE 10675 - FULL SIZE

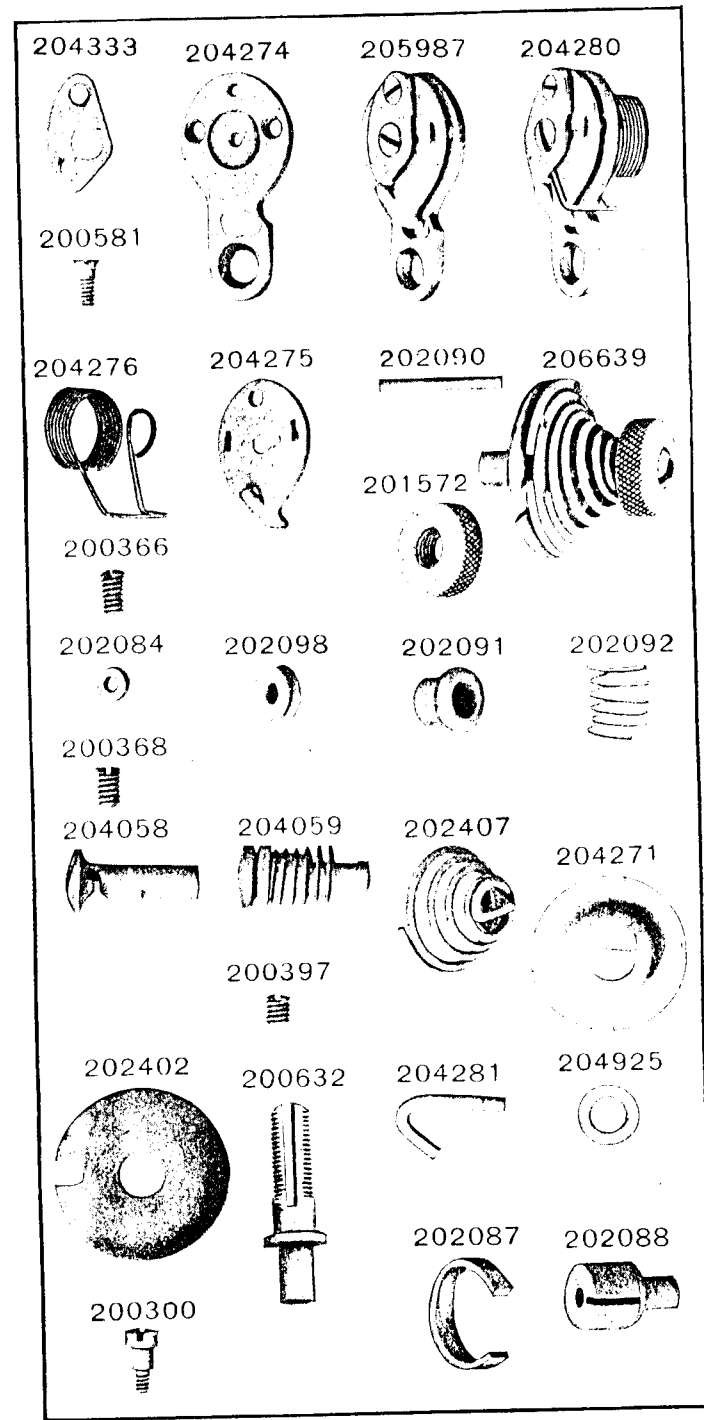


PLATE 10693 - ONE-FOURTH SIZE

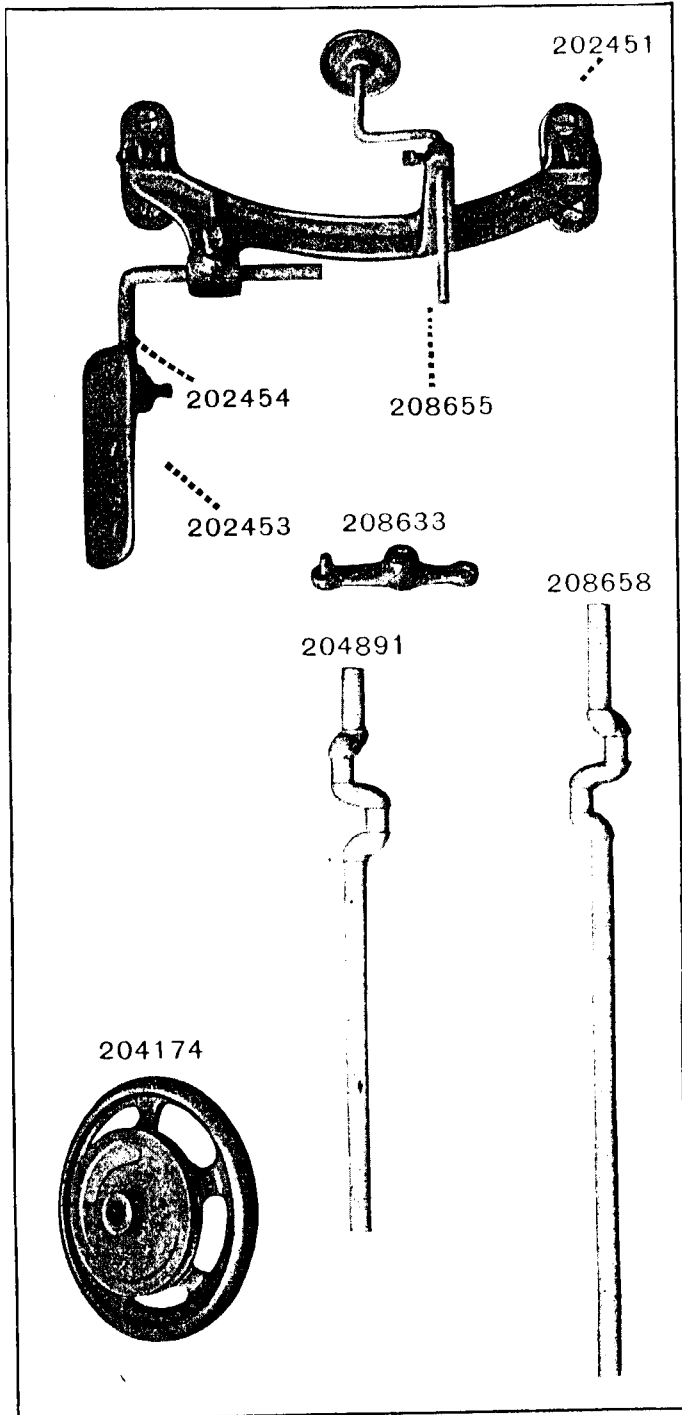


PLATE 10694 - FULL SIZE

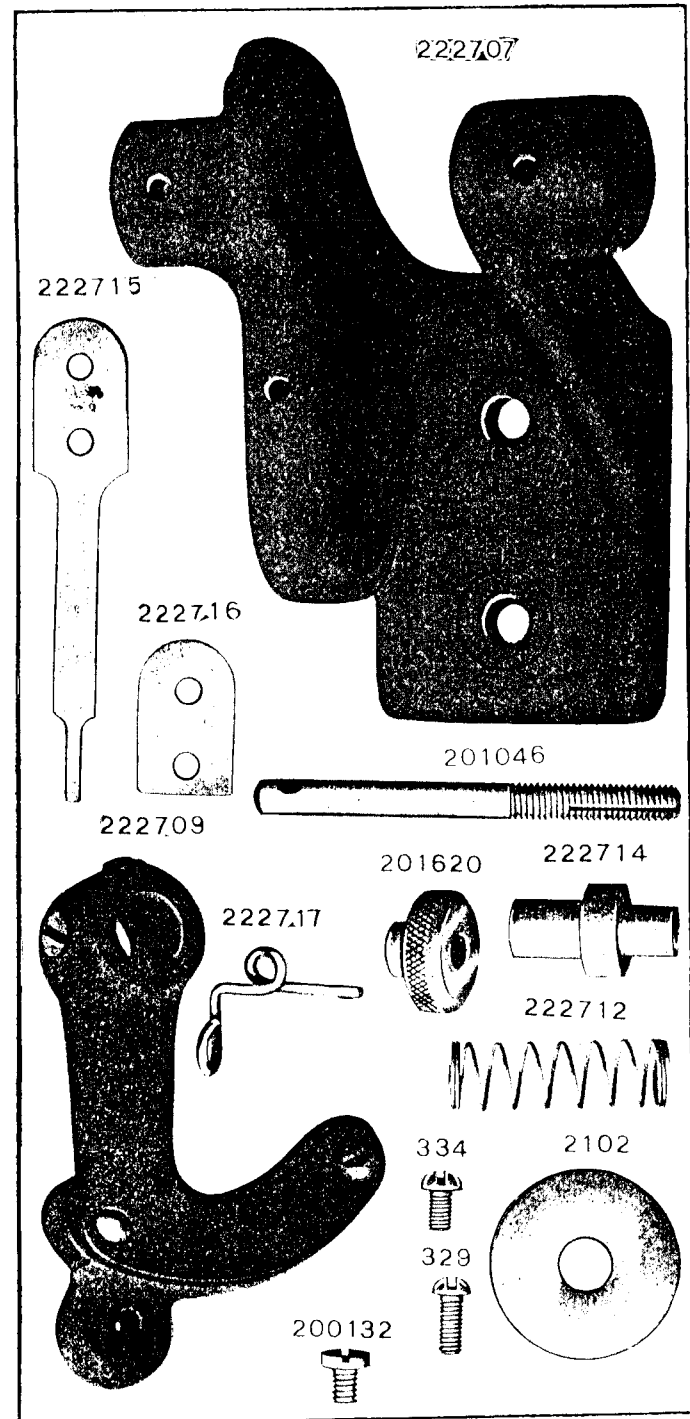
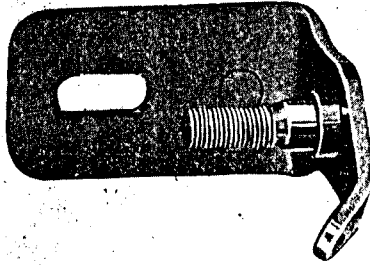


PLATE 10881—FULL SIZE

225461



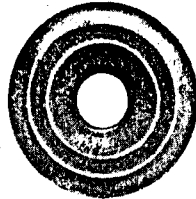
200082



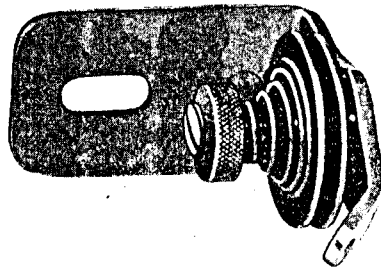
202104



2102



225462



202407



201499

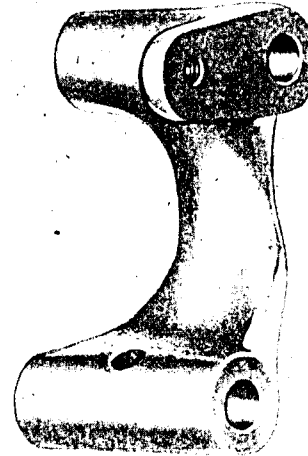


201572

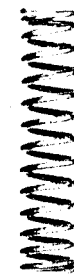


PLATE 10882—FULL SIZE

225453



225455



225438



200380



200056



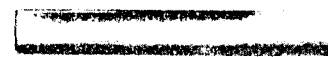
225456



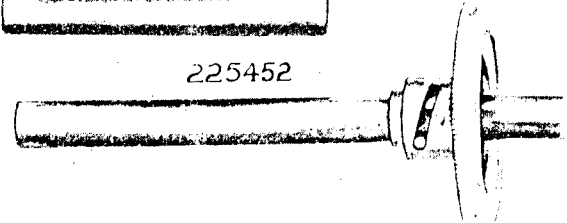
200299



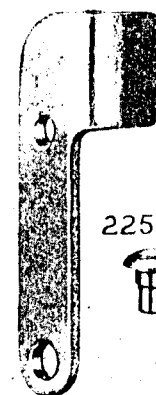
225454



225452



225458



202478



225444



225459



225460



PLATE 10883 ONE-FOURTH SIZE

225433



202473



225436

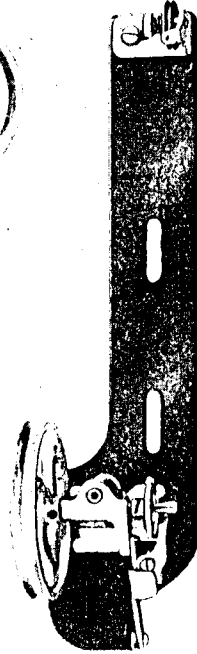


PLATE 12311—FULL SIZE

200570



200062



200439



200278



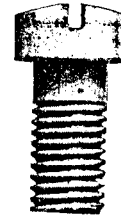
200335



200328



200963



200550



200271



200042



200577



200516



200362



200378



200053



200043



200575



200430



200840



200031



200437



200383



200106



200079



PLATE 12319 -FULL SIZE

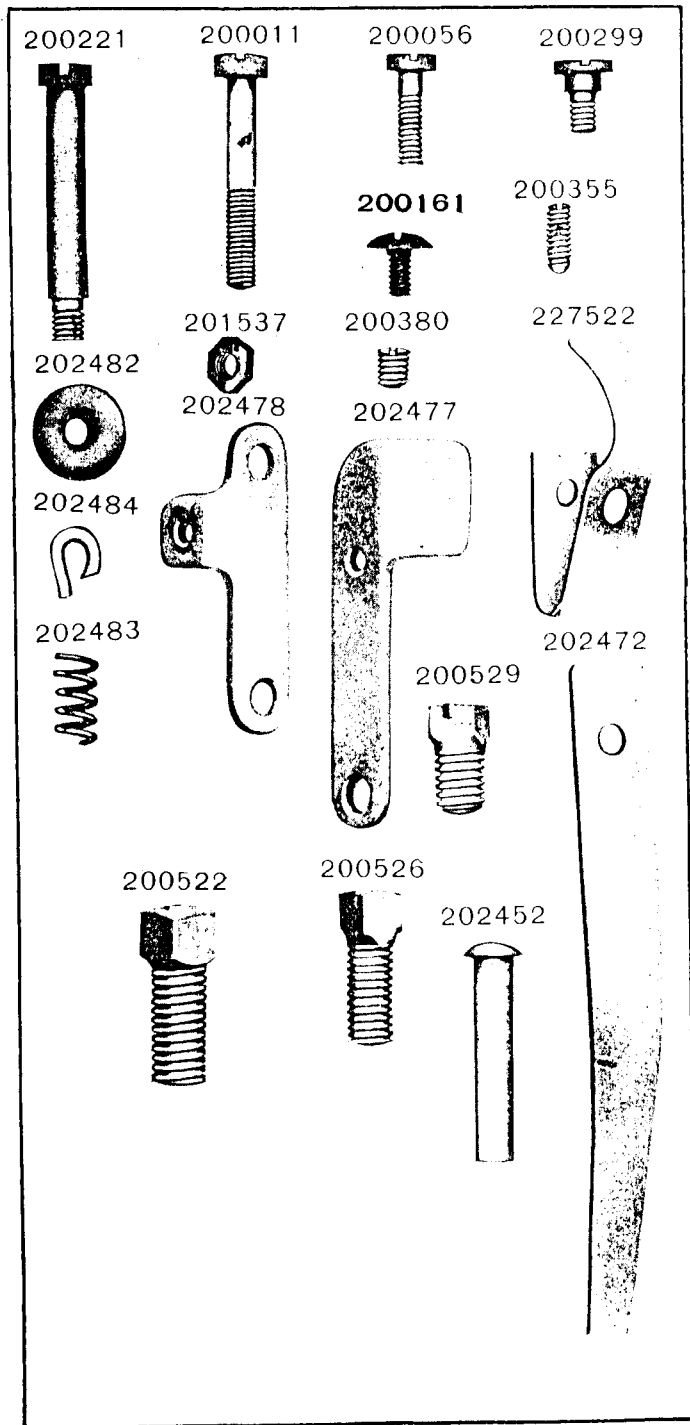


PLATE 12320 -ONE-HALF SIZE

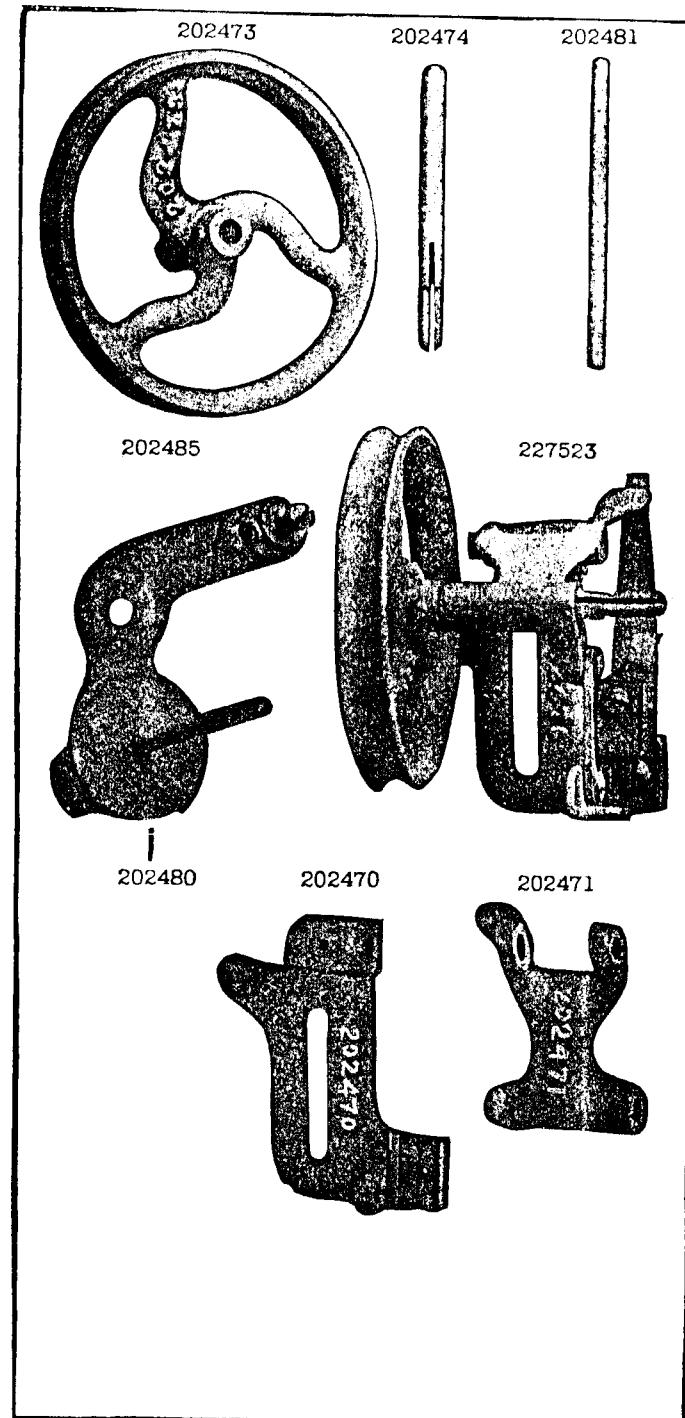




PLATE 12345—ONE-HALF SIZE

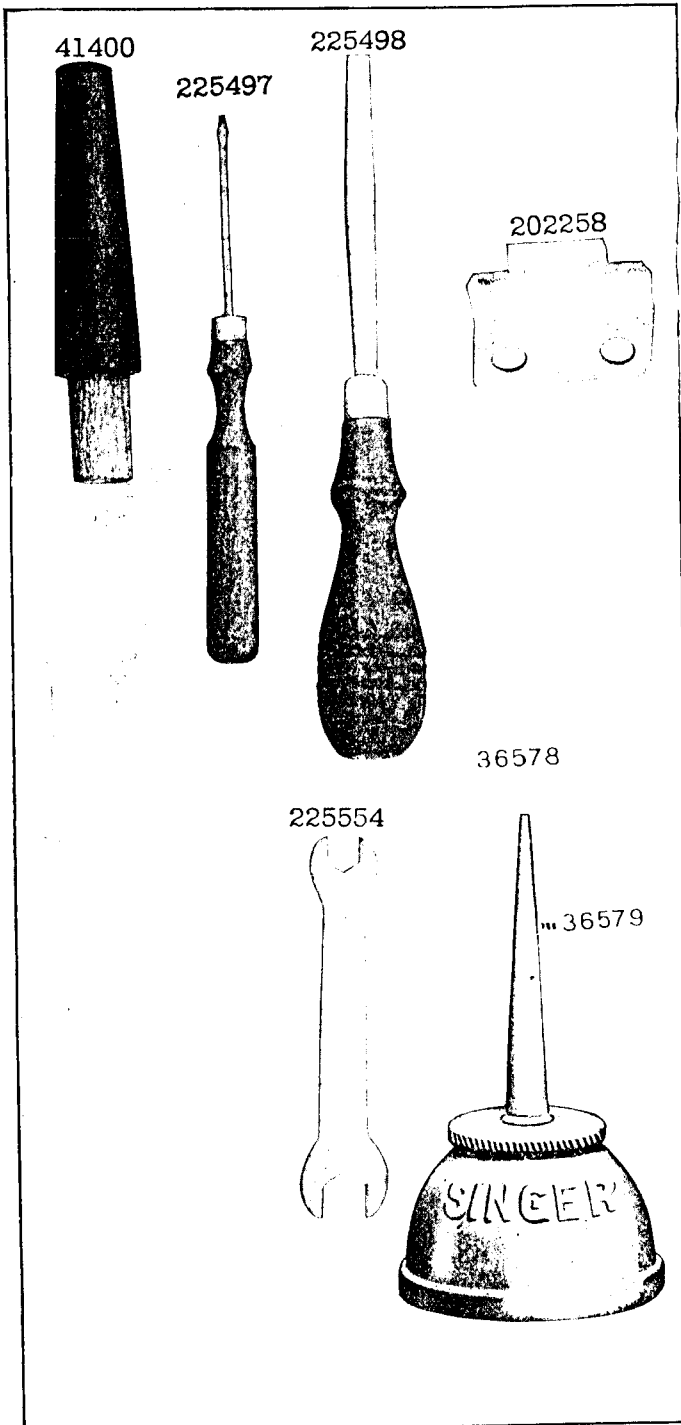


PLATE 12801—ONE-HALF SIZE

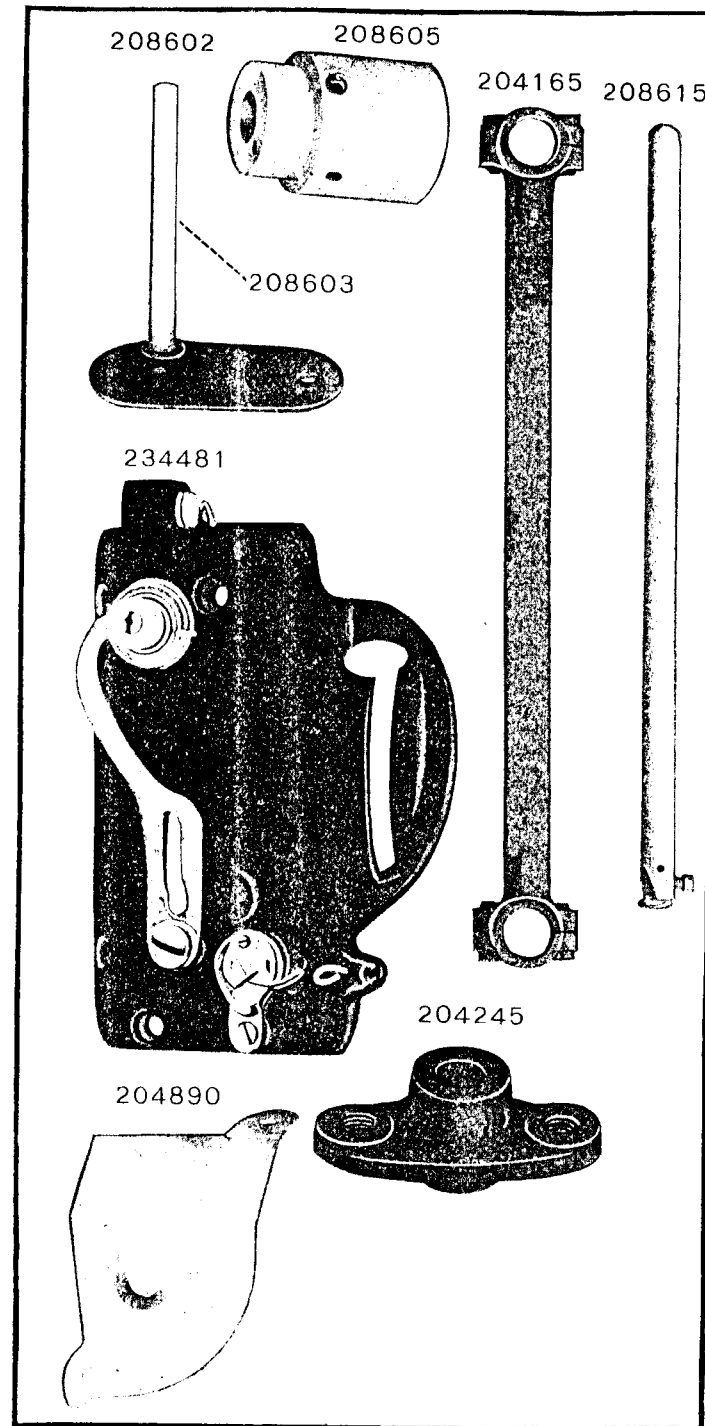


PLATE 12802-FULL SIZE

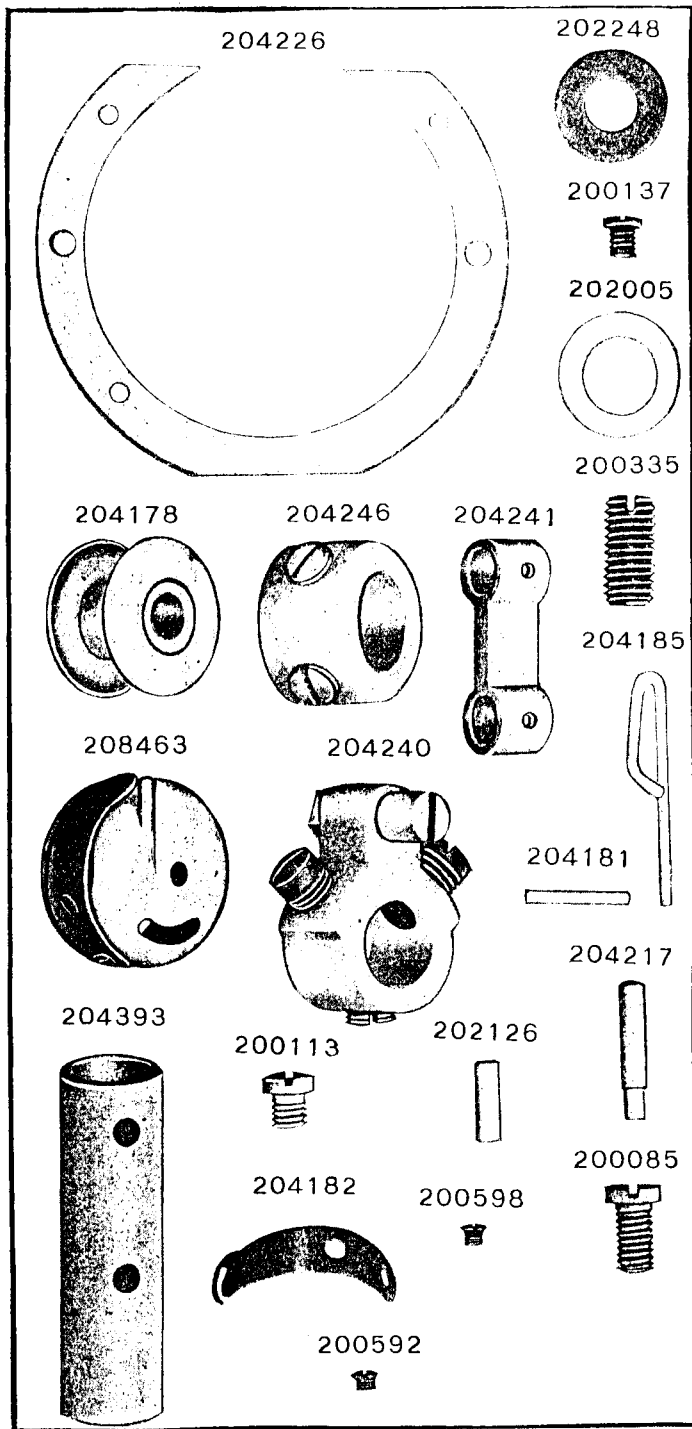


PLATE 12803-FULL SIZE

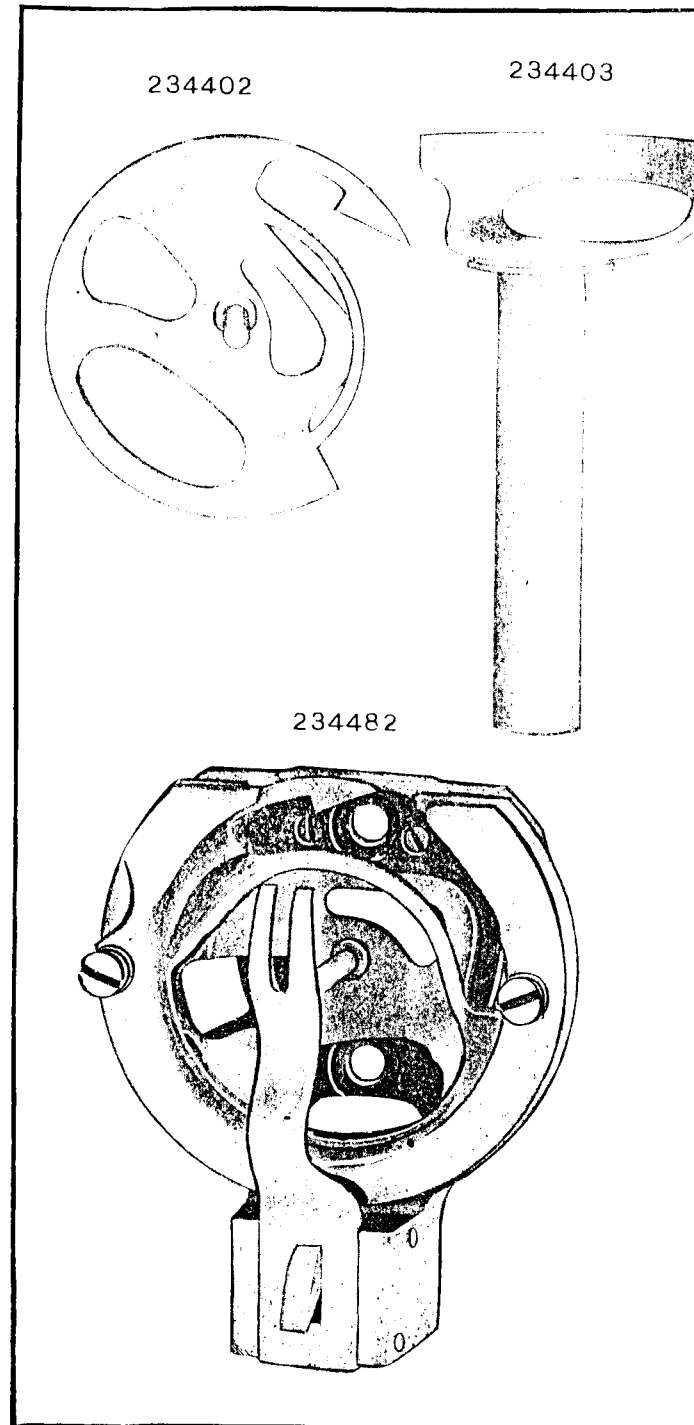


PLATE 12804-FULL SIZE

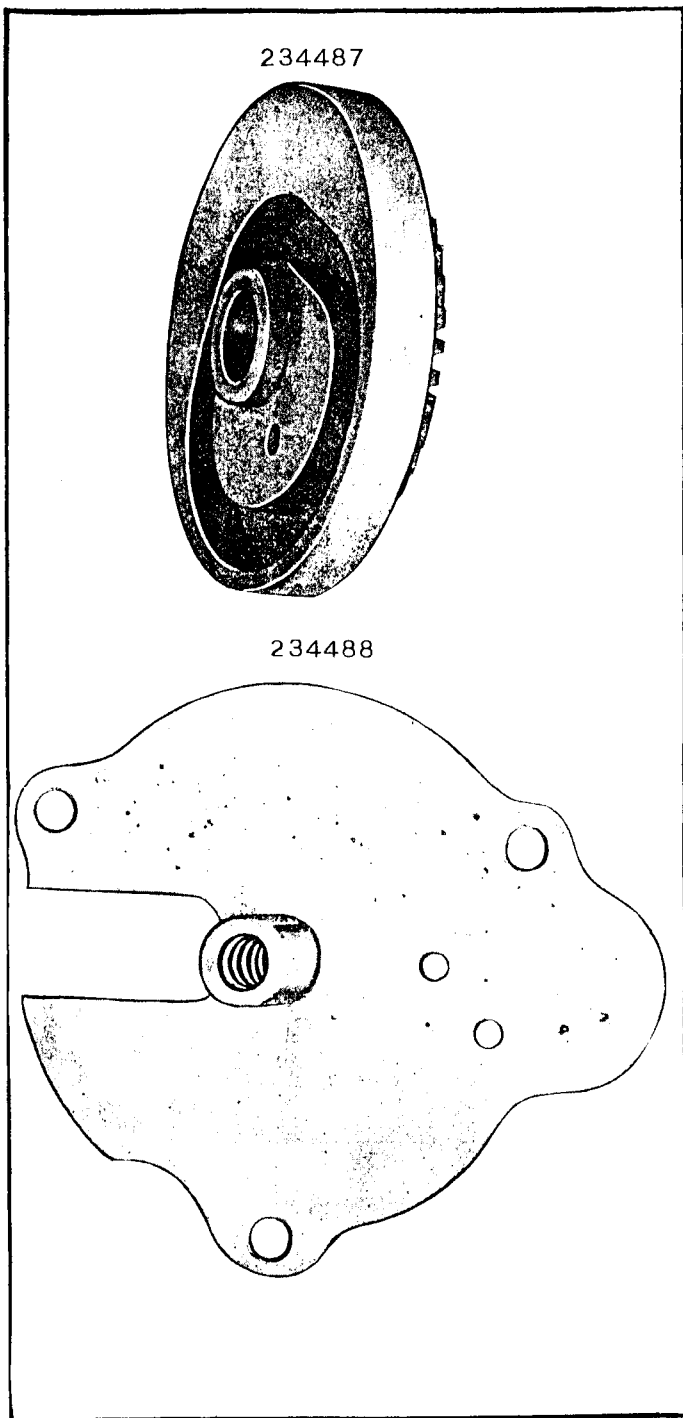


PLATE 12805-FULL SIZE

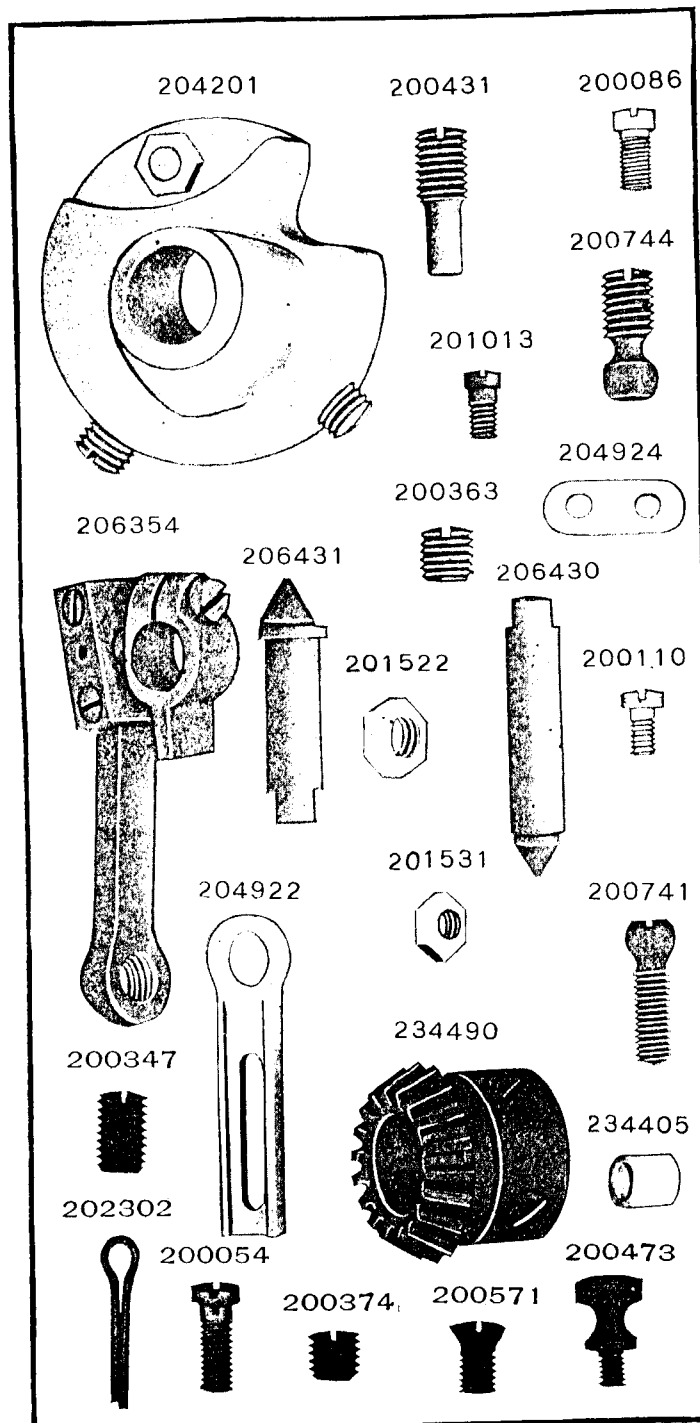


PLATE 12806-FULL SIZE

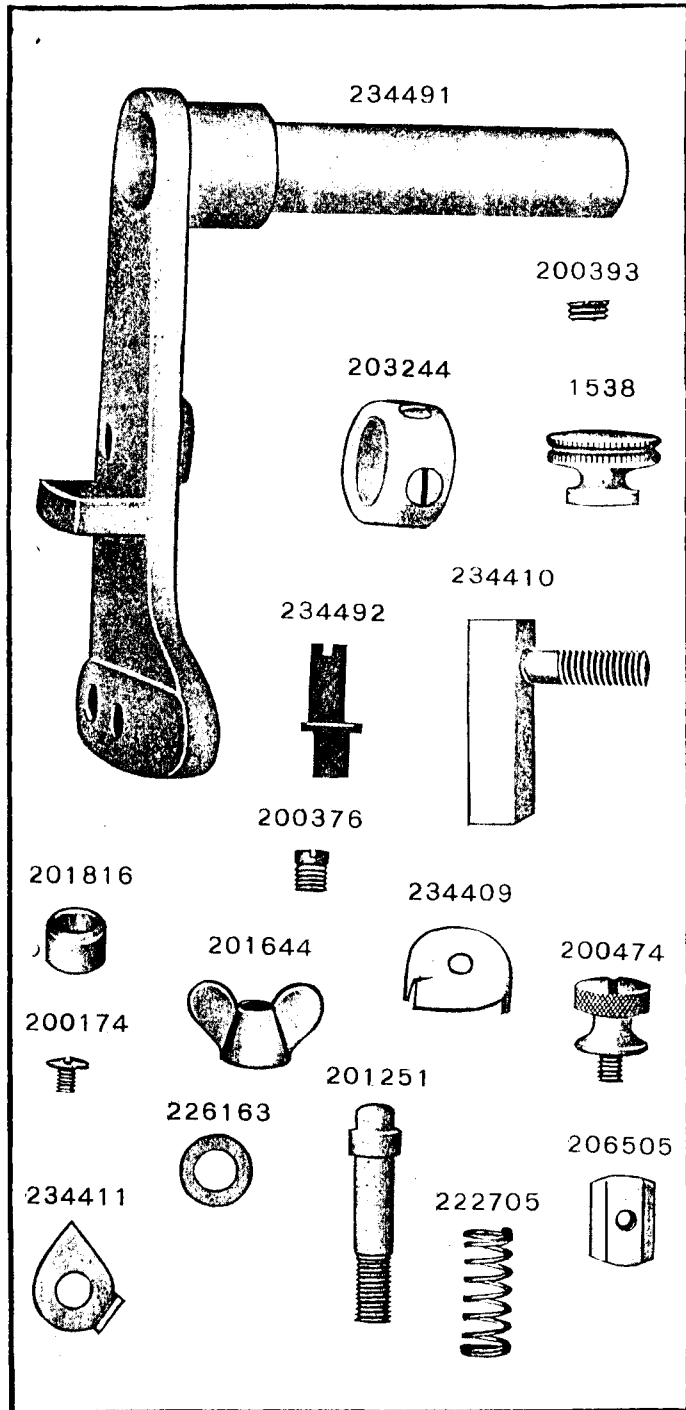


PLATE 12807-ONE-HALF SIZE

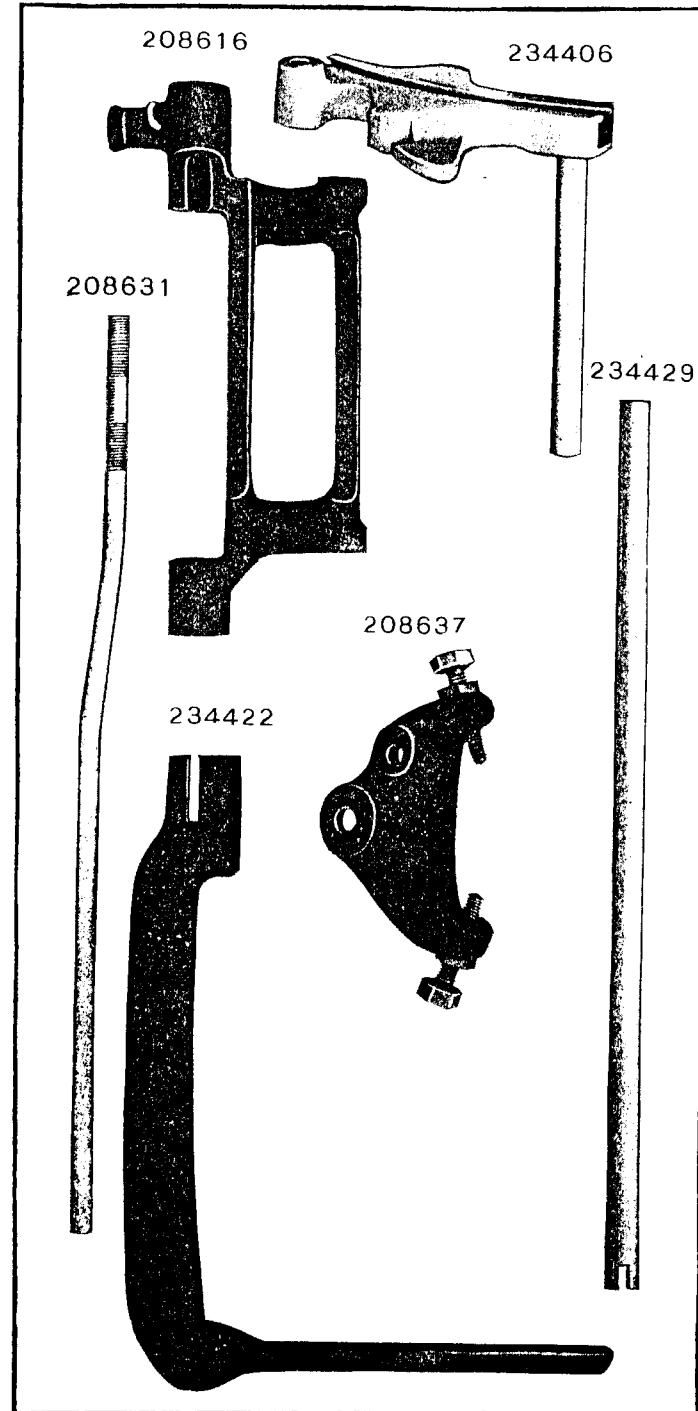


PLATE 12808-FULL SIZE

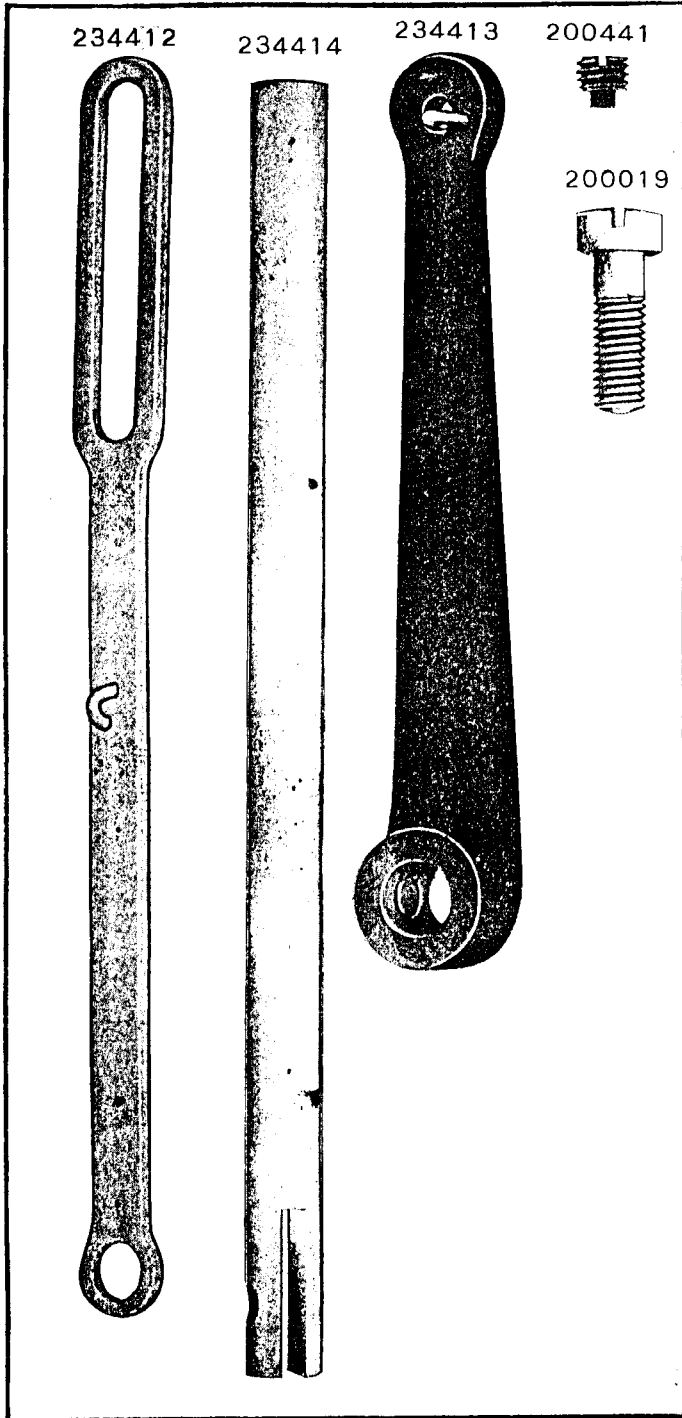


PLATE 12809-FULL SIZE

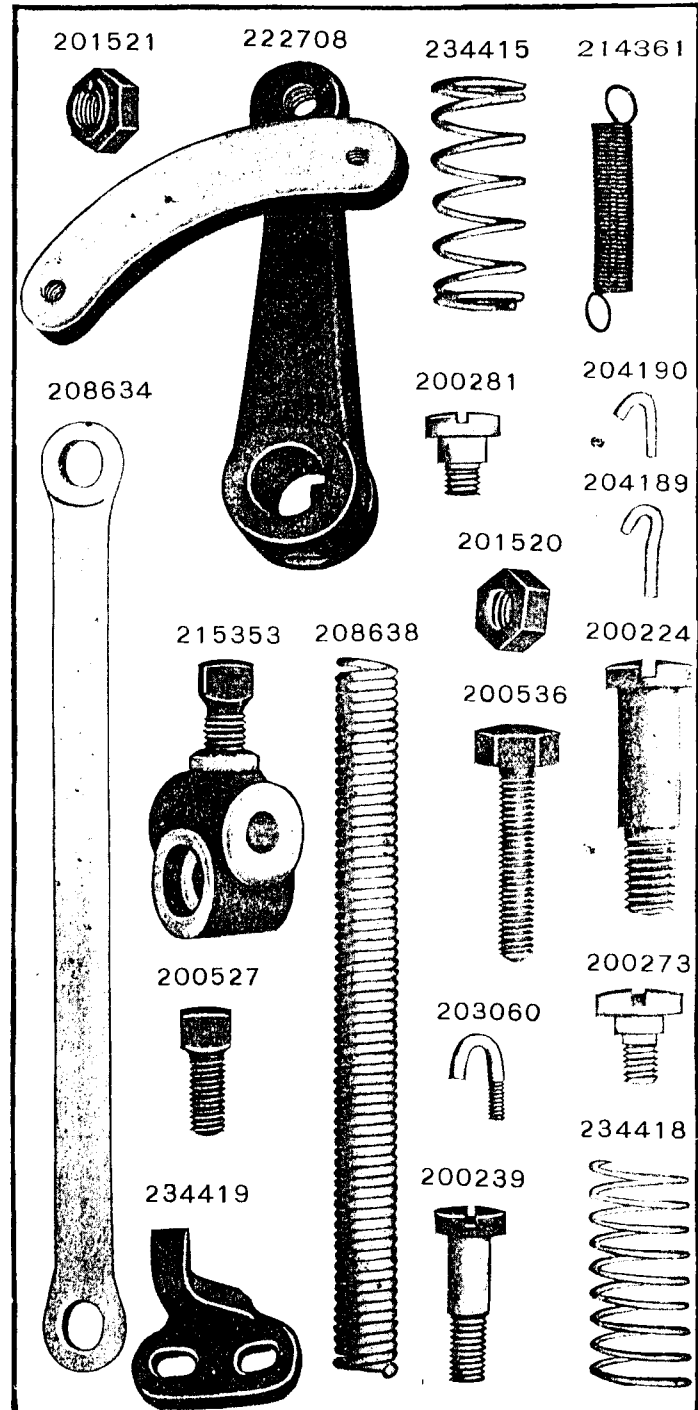


PLATE 12810-ONE-HALF SIZE

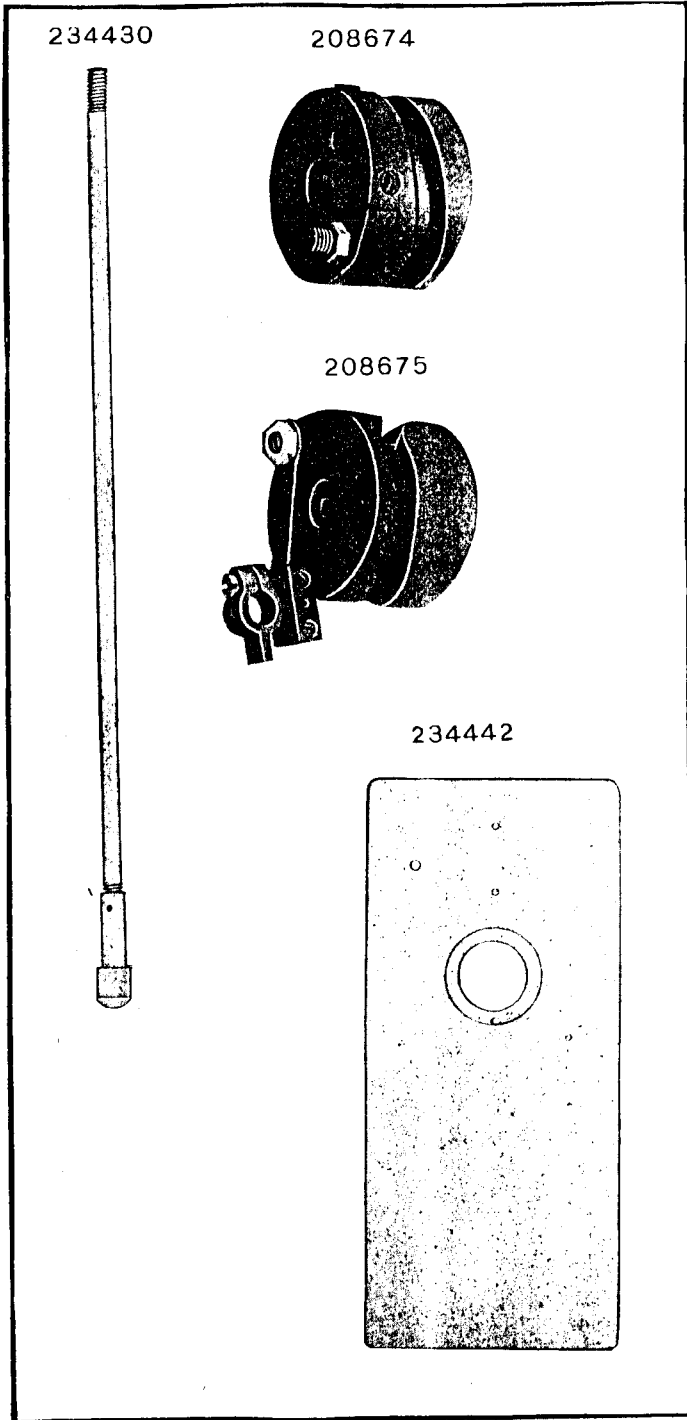


PLATE 12811-FULL SIZE

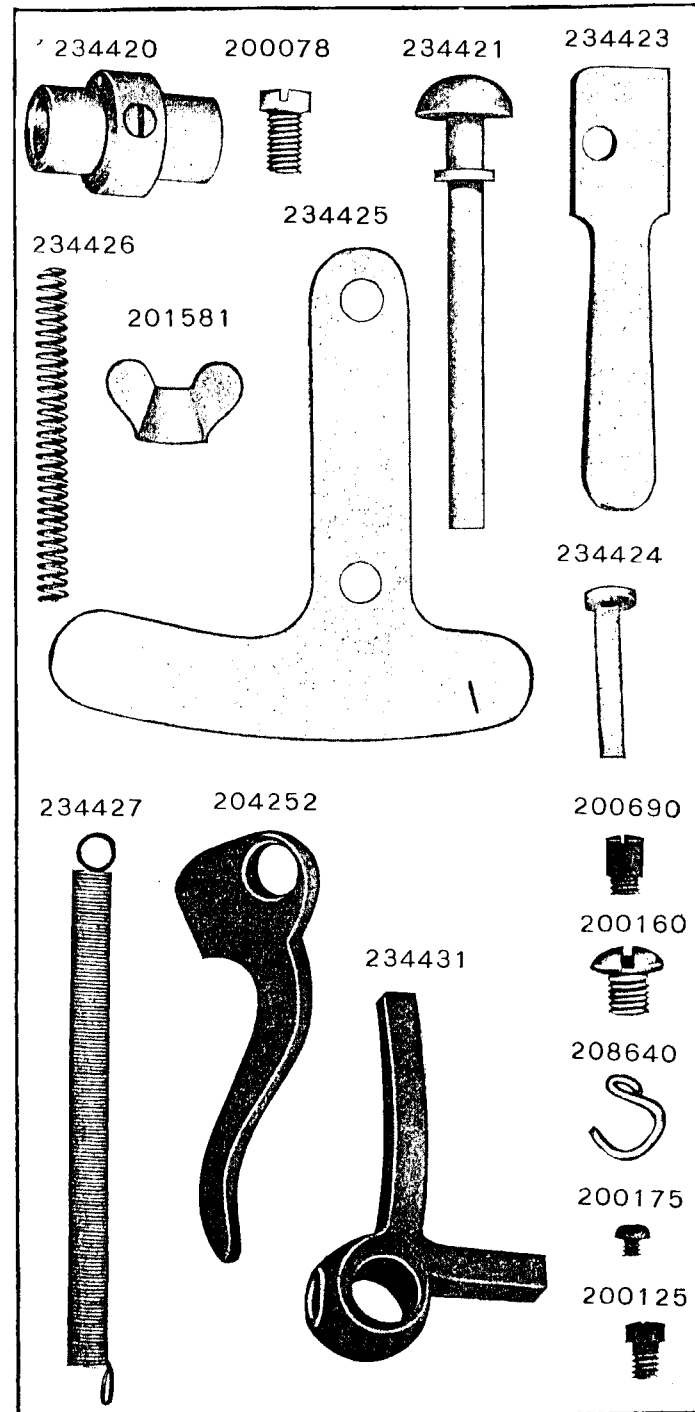


PLATE 12812-FULL SIZE

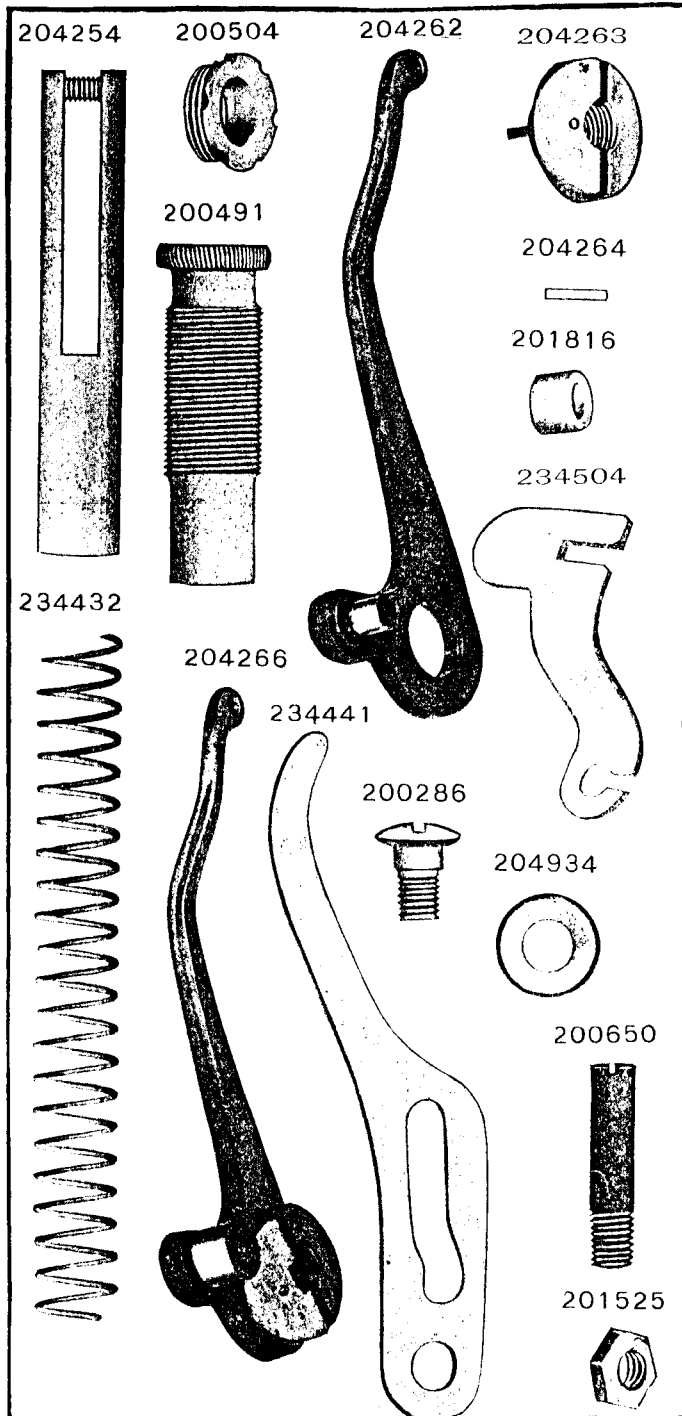


PLATE 12813-FULL SIZE

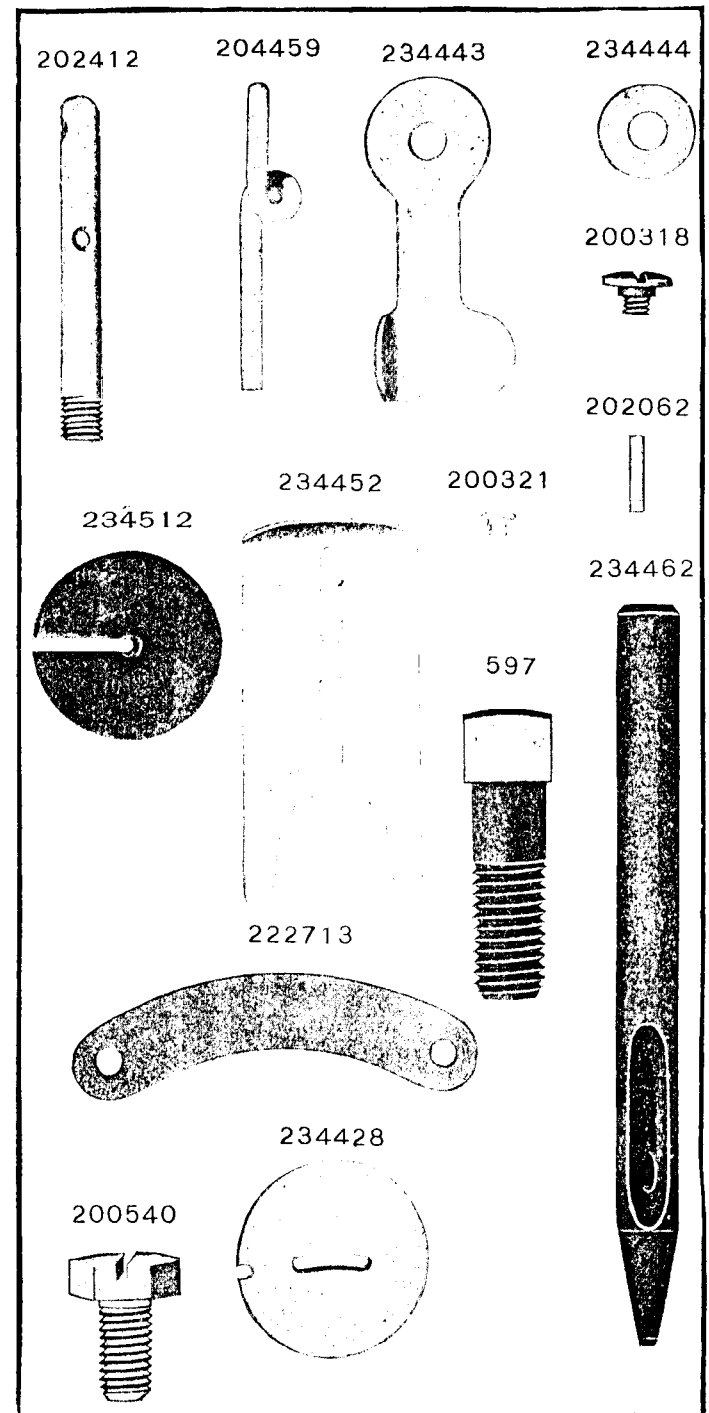


PLATE 12814-FULL SIZE

