

Singer 18-23

Singer 18-25

Form 19110  
(937)  
Printed in U. S. A.

**LIST  
OF  
PARTS**



**MACHINES**  
**Nos. 18-23 and 18-25**

**THE SINGER MANUFACTURING COMPANY**

## INSTRUCTIONS FOR OILING

To ensure easy running and prevent unnecessary wear of the parts which are in movable contact, the machine requires oiling and when in continuous use, it should be oiled at least twice each day with Singer Manufacturing Sewing Machine Oil (Cloth and Leather).

Copyright, U. S. A., 1935 and 1937  
by The Singer Manufacturing Co.  
All Rights Reserved for all Countries

## INDEX

|  | Page |
|--|------|
| Attachments and Accessories.....                     | 24   |
| Ball Bearing Roller Pressers with Ratchet Brake..... | 13   |
| Ball Bearing Roller Pressers.....                    | 12   |
| Bobbin Winder.....                                   | 24   |
| Foot Lifter Parts.....                               | 25   |
| Knee Lifter Parts.....                               | 25   |
| Machine Base.....                                    | 24   |
| Machine No. 18-23.....                               | 5    |
| Machine No. 18-25.....                               | 14   |
| Numerical List of Parts.....                         | 29   |
| Plain Roller Pressers.....                           | 11   |
| Thread Lubricators.....                              | 26   |

## INSTRUCTIONS FOR ORDERING

In ordering from this list, use ONLY the part NUMBER in the FIRST column.

The number stamped on a Sewing Machine Part is in every case the number of the single part only.

Every combination of parts sent out as such has its specific number, which, although not stamped on the parts, must be used when ordering the combination.

Each number always indicates the SAME PART in whatever list it appears, or for whatever machine.

The letters after some of the numbers indicate the style of finish only, as follows:

- A-Hardened, Polished, Nickel Plated and Buffed
- B-Polished, Nickel Plated and Buffed
- C-Hardened Only
- D-Polished Only
- E-Soft, Not Polished
- F-Hardened and Polished
- F.J-Hardened, Polished and Nickel Plated
- G-Bright Rumbled and Nickel Plated
- H-Blued
- J-Nickel Plated Only
- K-Hardened and Nickel Plated
- L-Brass Plated
- M-Oxidized
- N-Japanned, Dull
- P-Japanned, Bright
- R-Merlized
- S-Cadmium Plating
- T-Copper Plated
- T.A-Hardened, Polished, Copper and Nickel Plated and Buffed
- T.B-Copper and Nickel Plated and Polished
- T.J-Copper and Nickel Plated Only
- T.K-Hardened, Copper and Nickel Plated
- T.L-Copper and Brass Plated
- T.M-Copper Plated and Oxidized
- U-Zinc Plated
- V-Silver Plated
- W-Polished and Nickel Plated
- X-Black Oxide, for Iron and Steel
- X.C-Hardened and Black Oxide, for Iron or Steel
- Y-Black Nickel Plated Only
- Z-Chromium Plated
- Z.A-Hardened, Polished, Nickel Plated, Buffed and Chromium Plated
- Z.B-Polished, Nickel Plated, Buffed and Chromium Plated
- Z.C-Hardened and Chromium Plated
- Z.J-Nickel and Chromium Plated

These letters MUST BE USED when they appear in the list; and AFTER the number as in the list.

In this series:

1 to 1500, 50001 to 51500 and 140001 to 142000 are Screw Numbers

1501 to 1800 and 51501 to 51800 are Nut Numbers

1801 to 2000 and 51801 to 52000 are Roller Numbers

2001 to 50000 and 52001 to 140000 and 142001 to

190000 are Sewing Machine Parts, 190001 and upward

are numbers of Electrical Parts.

The figures in the second column refer only to the plates, illustrating the parts, and are NOT TO BE USED in ordering.

Parts marked with an asterisk (\*) are furnished only when repairs are made at factory.

When ordering parts which differ as to Gauge (the distance between seams) the Gauge, as well as the Number must be given on order.

## LIST OF PARTS COMPLETE FOR

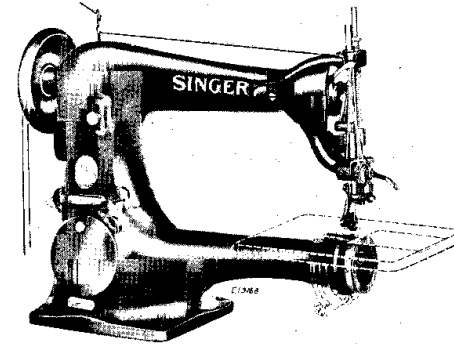

## MACHINE No. 18-23

FOR SHOE WORK AND OTHER WORK IN LEATHER.  
WHEEL FEED AT LEFT OF NEEDLE. ROLLER  
PRESSER. SPEED 1800 R. P. M.

| No.    | Plate | Name                                      |
|--------|-------|---|
| *16280 | ----  | Arm and Cylinder with 15404 and two 15405 |
| 16264  | 3699  | " Shaft.....                              |
| *16281 | ----  | " " 16264 with 3074, 16268 and 16269      |
| 3005   | 3698  | " " Bushing.....                          |
| 448C   | 3698  | " " " Set Screw.....                      |
| 16266  | 3698  | " " Counterbalance with 443C.....         |
| 443C   | 3698  | " " " Set Screw.....                      |
| 144D   | 3698  | " " Screw.....                            |
| 4288   | 22701 | " Side Cover (back).....                  |
| 51224W | 3698  | " " " Thumb Screw.....                    |
| 16102  | 22701 | " " " (front).....                        |
| 164J   | 3698  | " " " Screw.....                          |
| 52239  | 3698  | " Spool Pin and Thread Eyelet.....        |
| 8879   | 3698  | " " " Washer (cloth).....                 |

## PARTS FOR MACHINE No. 18-23

| No.    | Plate | Name  |
|--------|-------|---|
| 16267  | 3699  | Balance Wheel (disc) for Power Table, 2-3/4 in. pulley, with two 448C.....          |
| 16278  | 3699  | Balance Wheel (disc) for Stand, 3 in. pulley, for Clamp Stop Motion.....            |
| 448C   | 3698  | Balance Wheel Set Screw.....  |
| 256J   | 3698  | Clamp Stop Motion Clamp Screw.....  |
| 248A   | 3698  | " " " Stop Screw.....   |
| 2020   | 3698  | " " " Washer.....   |
| *3023  | ----- | " " " Flanged Bushing.....  |
| 4933   | 3698  | " " " " 3023 with two 462C.....   |
| 2022   | 22702 | Clamp Stop Motion Flanged Bushing Pin....   |
| 462C   | 22702 | " " " Set Screw   |
| 3022   | ----- | Clamp Stop Motion complete, Nos. 248A, 256J 2020 and 4933.....                      |
| 6786   | 3699  | Cloth Plate.....  |
| 6083   | 3699  | " " Bracket with two 345C.....  |
| 345C   | 22702 | " " " Set Screw.....  |
| 389F   | 22702 | " " " Screw.....  |
| 6496   | 3699  | " " " Slide.....  |
| 3286   | 22702 | " " " Spring.....   |
| 725J   | 22702 | " " " Screw.....  |
| 6495   | 3699  | Cloth Plate complete, Nos. 3286, 6496, 6786 and two 725J.....                       |
| 6494   | ----- | Cloth Plate with Bracket complete, Nos. 6083, 6495 and two 389F.....                |
| 4292   | 3683  | Crank Connecting Rod with two 145E.....   |
| 145E   | 3698  | " " " Cap Screw.....  |
| 375C   | 22702 | " " " Hinge Screw.....  |
| 1518J  | 22702 | " " " Nut.....  |
| 18045  | 22702 | Cylinder Oil Tube for oiling Oscillating Shaft.....                                 |
| 18036  | 22701 | Cylinder Side Cover.....  |
| 51224W | 3698  | " " " Thumb Screw.....  |
| 52165  | 22702 | Feed Connecting Link.....   |
| 375C   | 22702 | " " " Hinge Screw.....  |
| 1518J  | 22702 | " " " Nut.....  |
| 3074   | 22702 | " Eccentric with 446C.....  |
| 446C   | 22702 | " " " Set Screw.....  |
| 3037   | 3683  | " Forked Connection.....  |
| 375C   | 22702 | " " " Hinge Screw.....  |
| 1518J  | 22702 | " " " Nut.....  |
| 16177  | ----- | Feed Forked Connection complete, Nos. 3037 16241, 52165 and two each 375C and 1518J |
| 6459   | 22702 | Feed Regulator.....   |
| 18241  | ----- | " " " 6459 with 818D.....   |
| 58E    | 22704 | " " " Hinge Screw.....  |
| 818D   | 22702 | " " " Thumb Screw.....  |
| 6488   | 22703 | " Rock Shaft.....   |
| 6018   | 22704 | " " " Crank with 207F.....  |

## PARTS FOR MACHINE No. 18-23

| No.    | Plate | Name   |
|--------|-------|--|
| 156F   | 22704 | Feed Rock Shaft Crank Position Screw.....                      |
| 207F   | 22704 | " " " Set Screw.....   |
| 6497   | 22701 | " Wheel.....   |
| 6498   | 22701 | " " Driver.....  |
| 16168  | 22702 | " " " Spring.....  |
| 207F   | 22704 | " " " Screw.....   |
| 16246  | 22704 | " " Friction Spring.....                                       |
| 207F   | 22704 | " " " Screw.....   |
| 16268  | 3683  | Needle Bar (hollow).....                                       |
| *3045  | 22705 | " " Connecting Link.....                                       |
| 16220  | ----- | " " " 3045 with 377C 1518J and 6487.....                       |
| 377C   | 22705 | Needle Bar Connecting Link Hinge Screw...                      |
| 1518J  | 22702 | " " " Nut  |
| 6487   | 22705 | " " " Stud with 155C....                                       |
| 155C   | 22705 | " " " Set Screw.....   |
| 290E   | 22705 | " " Screw Bushing.....   |
| 4302   | 22705 | " " Thread Guide.....  |
| 233J   | 22705 | " " " Screw.....   |
| 4303   | 22705 | " Clamp with 808F.....   |
| 808F   | 22705 | " " Screw.....   |
| *6461  | 22701 | Oscillating Rock Shaft with 4784.....                          |
| 16176  | ----- | Oscillating Rock Shaft complete, Nos. 6461 and 16212.....      |
| 6489   | 3683  | Oscillating Rock Shaft Hinge Pin.....                          |
| *16212 | ----- | " " " 6489 with 1513J.....                                     |
| 1513J  | 22705 | Oscillating Rock Shaft Hinge Pin Nut.....                      |
| 4784   | 22705 | " " " Oil Pad.....   |
| 16055  | 22703 | " Shaft.....   |
| *16184 | ----- | " " 16055 with 2049, 6056 and 6499.....                        |
| *6056  | ----- | Oscillating Shaft Crank with 460C and 1813.....                |
| 6024   | 22705 | Oscillating Shaft Crank with 1813 and two 462C.....            |
| 2049   | 22705 | Oscillating Shaft Crank Pin.....                               |
| 1813   | 22705 | " " " Roller and Stud..  |
| 462C   | 22702 | " " " Set Screw for 6024.....                                  |
| 460C   | 22705 | Oscillating Shaft Crank Set Screw for 6056.....                |
| 3054   | 3683  | Presser Bar.....   |
| 6464   | 3683  | " " Lifter.....  |
| 77J    | 22706 | " " " Screw.....   |
| 6465   | 22706 | " " " Washer.....  |
| 16194  | 3683  | " " Lifting Bracket with 175J and two 457K.....                |
| 16195  | 3683  | Presser Bar Lifting Bracket 16194 with 16196 and two 335J..... |

## PARTS FOR MACHINE No. 18-23

| No.    | Plate | Name  |
|--------|-------|---|
| 175J   | 22706 | Presser Bar Lifting Bracket Adjusting Screw.....  |
| 6469   | 3683  | Presser Bar Lifting Bracket Guide.....  |
| 175J   | 22706 | " " " " " Screw..   |
| 457K   | 22706 | " " " " " Set Screw....   |
| 16196  | 3683  | " " " " " Wearing Plate   |
| 335J   | 22706 | " " " " " Screw.....  |
| 290E   | 22705 | Presser Bar Screw Bushing.....  |
| 5459   | 3683  | " " Spring (light) .047" wire...  |
| 6466   | ----- | " " " (medium) .055" wire...  |
| 6467   | ----- | " " " (heavy) .063" wire...   |
| 2070   | 22706 | " " " Washer.....   |
| 2180   | 22704 | " " Foot.....   |
| 190J   | 22704 | " " Screw.....  |
| 262J   | 3683  | Pressure Regulating Thumb Screw.....  |
| 1841   | 3681  | Roller, 7/8 in. diam., 9/64 in. face, fine with 652D and 1528J.....   |
| 2203   | 3681  | Roller Arm.....   |
| 440F   | 3689  | " " Adjusting Screw.....  |
| 1547J  | 3689  | " " " " " Nut.....  |
| 2206   | 3681  | " " Bracket.....  |
| 2205   | 3689  | " " Lock Spring.....  |
| 176J   | 3689  | " " " " " Screw.....  |
| 1549J  | 3689  | " " " " " Nut.....  |
| 316F   | 3689  | " " Screw Center.....   |
| 15444  | ----- | " " " " " 316F with 1547J..   |
| 1547J  | 3689  | " " " " " Nut.....  |
| 2197   | 3681  | Roller Presser complete, 7/8 in. diam., 9/64 in. face, fine roller, Nos. 176J 440F, 1547J, 1549J, 1841, 2203, 2205, 2206 and two 15444..... |
| 190J   | 22704 | Roller Presser Screw.....   |
| 652D   | 3689  | " " Screw.....  |
| 1528J  | 3689  | " " Nut.....  |
| 2073   | 3689  | Shuttle Bobbin.....   |
| 2211   | 3689  | " " Retaining Spring.....   |
| 2212   | 3689  | " " " " " Rivet....   |
| *8058  | ----- | " " Body with 398E, 2082, 2084, 2211 and two 2212.....  |
| *2075  | ----- | Shuttle Cover.....  |
| *44001 | ----- | " " " " " 2075 with 112E, 466H, 2078, 2080, 2086 and 2090.....  |
| 2076   | 3689  | Shuttle Cover Hinge Pin.....  |
| 2078   | 3689  | " " Delivery Eye Thread Guard.....  |
| 2080   | 3689  | " " " " " Rivet..   |
| 2082   | 3689  | " " Main Spring.....  |
| 398E   | 3689  | " " " " " Screw.....  |
| 2084   | 3689  | " " " " " Steady Pin.....   |
| 466H   | 3689  | " " Tension Regulating Screw.....   |

## PARTS FOR MACHINE No. 18-23

| No.    | Plate | Name  |
|--------|-------|---|
| 2086   | 3689  | Shuttle Tension Spring.....   |
| 2090   | 3689  | " " " " " Plate.....  |
| 112E   | 3689  | " " " " " Screw.....  |
| 6028   | 3689  | Shuttle (high point) complete, Nos. 2073, 2076, 6058 and 44001..... |
| 6499   | 22710 | Shuttle Driver.....   |
| 2049   | 22705 | " " Pin.....  |
| 18046  | 22713 | " " Race Ring.....  |
| 6472   | 22713 | " " " " " Latch.....  |
| 725J   | 22702 | " " " " " Screw.....  |
| 6500   | 22713 | Shuttle Race Ring complete, Nos. 6472, 16046 and two 725J.....      |
| 50008J | 22710 | Shuttle Race Ring Screw.....  |
| 2102   | 3686  | Tension Disc.....   |
| 1560C  | 3686  | " " Regulating Thumb Nut.....                                       |
| 16279  | 3686  | " " Releaser.....   |
| 16240  | 3686  | " " " " " Collar with 7393 and two 1253C.....                       |
| 7393   | 3686  | Tension Releaser Collar Pin.....                                    |
| 1253C  | 3686  | " " " " " Set Screw.....  |
| 50116K | 3686  | " " " " " Screw.....  |
| 600C   | 3686  | " " Screw Stud.....   |
| 16202  | ----- | " " " " " 600C with 1560C.....                                      |
| 175J   | 22706 | " " " " " Set Screw.....  |
| 2103   | 3686  | " " Spring.....   |
| 16022  | 3686  | " " Thread Guard.....   |
| 219J   | 3686  | " " " " " Screw.....  |
| 16204  | ----- | Tension complete, Nos. 2103, 16202 and two 2102.....                |
| 2106   | 3686  | Thread Eyelet (front of arm).....                                   |
| *16269 | ----- | " " Take-up Cam.....  |
| 16270  | 3692  | " " " " " 16269 with 446C.....                                      |
| 3012   | 22711 | " " " " " Pin.....  |
| 446C   | 22702 | " " " " " Set Screw.....  |
| *6474  | 3686  | " " " " " Lever with 1819.....                                      |
| 16180  | ----- | " " " " " 6474 with 76F.....  |
| 76F    | 3686  | " " " " " Hinge Screw.....  |
| 1819   | 3686  | " " " " " Roller and Stud.....                                      |
| 6768   | 3686  | " " " " " Spring.....   |
| 6477   | 3686  | " " " " " Regulator Plate.....                                      |
| 233J   | 22705 | " " " " " " " Ad-justing Screw.....                                 |
| 16243  | 22713 | Throat Ring.....  |
| 16244  | 22713 | " " " " " 16243 with 665J and 16262....                             |
| 16262  | 22711 | " " " " " Needle Plate.....   |
| 665J   | 3689  | " " " " " " " Screw.....  |
| 399J   | 22711 | " " " " " " " Screw.....  |
| 16245  | ----- | Throat Ring complete, Nos. 6500, 16244 and two 50008J.....          |

PARTS FOR MACHINE No. 18-23

| No.    | Plate | Name            |
|--------|-------|-----------------|
| 18077  | 3693  | Dr-1p Pan.....  |
| *15404 | ----  | Trade Mark..... |
| 15405  | ----  | " " Rivet.....  |

Genuine Singer Needles should be used  
 in Singer Machines.  
 These Needles and their Containers  
 are marked with the  
 Company's Trade Mark "SIMANCO." 1

Needles in Containers marked  
 "For Singer Machines"  
 are not Singer made needles. 2

PLAIN ROLLER PRESSERS

FOR MACHINE No. 18-23

| Diameter of Roller               | 7/8"   |       | 1 1/4" |       | 1 1/4" |       | 1 1/4" |       | 1 1/4" |       |
|----------------------------------|--------|-------|--------|-------|--------|-------|--------|-------|--------|-------|
|                                  | coarse | fine  | coarse | fine  | coarse | fine  | coarse | fine  | coarse | fine  |
| Face of Roller                   | 9/64"  | 9/64" | 1/8"   | 9/64" | 9/64"  | 9/64" | 3/16"  | 3/16" | 3/16"  | 3/16" |
| Knurled Roller                   | 1868   | 1841  | 1823   | 1898  | 1839   | 1869  | 1897   | 1898  | 1898   | 1898  |
| Roller                           | 2205   | 2205  | 16098  | 16098 | 16098  | 16098 | 16098  | 16098 | 16098  | 16098 |
| Roller Arm Adjusting Screw       | 440F   | 440F  | 440F   | 440F  | 440F   | 440F  | 440F   | 440F  | 440F   | 440F  |
| Roller Arm Adjusting Screw Nut   | 1547J  | 1547J | 1547J  | 1547J | 1547J  | 1547J | 1547J  | 1547J | 1547J  | 1547J |
| Roller Arm Bracket               | 2205   | 2205  | 4282   | 4282  | 4282   | 4282  | 4282   | 4282  | 4282   | 4282  |
| Roller Arm Lock Spring           | 2205   | 2205  | 2205   | 2205  | 2205   | 2205  | 2205   | 2205  | 2205   | 2205  |
| Roller Arm Lock Spring Screw     | 176J   | 176J  | 176J   | 176J  | 176J   | 176J  | 176J   | 176J  | 176J   | 176J  |
| Roller Arm Lock Spring Screw Nut | 1549J  | 1549J | 1549J  | 1549J | 1549J  | 1549J | 1549J  | 1549J | 1549J  | 1549J |
| Roller Arm Screw Center          | 316F   | 316F  | 316F   | 316F  | 316F   | 316F  | 316F   | 316F  | 316F   | 316F  |
| Roller Arm Screw Center Nut      | 1547J  | 1547J | 1547J  | 1547J | 1547J  | 1547J | 1547J  | 1547J | 1547J  | 1547J |
| Roller Screw                     | 652D   | 652D  | 652D   | 396D  | 396D   | 396D  | 396D   | 396D  | 396D   | 396D  |
| Roller Screw Nut                 | 1528J  | 1528J | 1528J  | 1528J | 1528J  | 1528J | 1528J  | 1528J | 1528J  | 1528J |
| Roller Presser complete          | 2196   | 2197  | 16228  | 16228 | 16099  | 16100 | 16225  | 16225 | 16225  | 16225 |



**BALL BEARING ROLLER PRESSERS**  
FOR MACHINE No. 18-23

| Diameter of Roller               | 1 1/4" | 1 1/4" | 1 1/4" | 1 1/4" | 1 1/4" | 1 1/4" |
|----------------------------------|--------|--------|--------|--------|--------|--------|
| Face of Roller                   | 5/32"  | coarse | 3/16"  | coarse | 7/32"  | coarse |
| Knurl of Roller                  | 51841  | 51849  | 51851  | 51860  | 51860  | 51832  |
| Roller complete                  | 16230  | 16230  | 16230  | 16230  | 16230  | 16230  |
| Roller Arm                       | 440F   | 440F   | 440F   | 440F   | 440F   | 440F   |
| Roller Arm Adjusting Screw       | 1547J  | 1547J  | 1547J  | 1547J  | 1547J  | 1547J  |
| Roller Arm Adjusting screw Nut   | 4282   | 4282   | 4282   | 4282   | 4282   | 4282   |
| Roller Arm Bracket               | 2205   | 2205   | 2205   | 2205   | 2205   | 2205   |
| Roller Arm Lock Spring           | 176J   | 176J   | 176J   | 176J   | 176J   | 176J   |
| Roller Arm Lock Spring Screw     | 1549J  | 1549J  | 1549J  | 1549J  | 1549J  | 1549J  |
| Roller Arm Lock Spring Screw Nut | 316F   | 316F   | 316F   | 316F   | 316F   | 316F   |
| Roller Arm Screw Center          | 1547J  | 1547J  | 1547J  | 1547J  | 1547J  | 1547J  |
| Roller Arm Screw Center Nut      | 16232  | 16232  | 16232  | 16232  | 16232  | 16232  |
| Roller Ball                      | 1766C  | 1766C  | 1766C  | 1766C  | 1766C  | 1766C  |
| Roller Ball Retaining Nut        | 50653C | 50653C | 50653C | 50653C | 50653C | 50653C |
| Roller Screw                     | 1528J  | 1528J  | 1528J  | 1528J  | 1528J  | 1528J  |
| Roller Presser complete          | 16226  | 65086  | 65047  | 65041  | 65041  | 16223  |

**BALL BEARING ROLLER PRESSERS WITH RATCHET BRAKE**  
FOR MACHINE No. 18-23

| Diameter of Roller                           | 1 1/4" | 1 1/4" | 1 1/4" | 1 1/4" | 1 1/4" | 1 1/4" | 1 1/4" | 1 1/4" |
|--|--------|--------|--------|--------|--------|--------|--------|--------|
| Face of Roller                               | 1/8"   | 9/64"  | 3/16"  | 7/32"  | 7/32"  | 7/32"  | 7/32"  | 7/32"  |
| Knurl of Roller                              | 51892  | 51906  | 51922  | 51915  | 51921  | 51915  | 51904  | 51904  |
| Roller complete                              | 65095  | 65095  | 65125  | 65095  | 65095  | 65095  | 65095  | 65095  |
| Roller Arm                                   | 440F   | 440F   | 440F   | 440F   | 440F   | 440F   | 440F   | 440F   |
| Roller Arm Adjusting Screw                   | 1547J  | 1547J  | 1547J  | 1547J  | 1547J  | 1547J  | 1547J  | 1547J  |
| Roller Arm Adjusting screw Nut               | 4282   | 4282   | 4282   | 4282   | 4282   | 4282   | 4282   | 4282   |
| Roller Arm Bracket                           | 2205   | 2205   | 2205   | 2205   | 2205   | 2205   | 2205   | 2205   |
| Roller Arm Lock Spring                       | 176J   | 176J   | 176J   | 176J   | 176J   | 176J   | 176J   | 176J   |
| Roller Arm Lock Spring Screw                 | 1549J  | 1549J  | 1549J  | 1549J  | 1549J  | 1549J  | 1549J  | 1549J  |
| Roller Arm Lock Spring Screw Nut             | 316F   | 316F   | 316F   | 316F   | 316F   | 316F   | 316F   | 316F   |
| Roller Arm Screw Center                      | 1547J  | 1547J  | 1547J  | 1547J  | 1547J  | 1547J  | 1547J  | 1547J  |
| Roller Arm Screw Center Nut                  | 16232  | 16232  | 16232  | 16232  | 16232  | 16232  | 16232  | 16232  |
| Roller Ball                                  | 1766C  | 1766C  | 1766C  | 1766C  | 1766C  | 1766C  | 1766C  | 1766C  |
| Roller Ball Retaining Nut                    | 62853  | 62853  | 62853  | 62853  | 62853  | 62853  | 62853  | 62853  |
| Roller Ratchet Spring Stop                   | 62851  | 62851  | 62851  | 62851  | 62851  | 62851  | 62851  | 62851  |
| Roller Ratchet Spring Stop Bracket           | 62854  | 62854  | 62854  | 62854  | 62854  | 62854  | 62854  | 62854  |
| Roller Ratchet Spring Stop Bracket complete  | 230F   | 230F   | 230F   | 230F   | 230F   | 230F   | 230F   | 230F   |
| Roller Ratchet Spring Stop Bracket Screw     | 665J   | 665J   | 665J   | 665J   | 665J   | 665J   | 665J   | 665J   |
| Roller Ratchet Spring Stop Bracket Screw Nut | 50653C | 50653C | 50653C | 50653C | 50653C | 50653C | 50653C | 50653C |
| Roller Screw                                 | 1528J  | 1528J  | 1528J  | 1528J  | 1528J  | 1528J  | 1528J  | 1528J  |
| Roller Presser complete                      | 65099  | 65100  | 65125  | 65101  | 65123  | 65097  | 16258  | 16258  |

LIST OF PARTS COMPLETE  
FOR

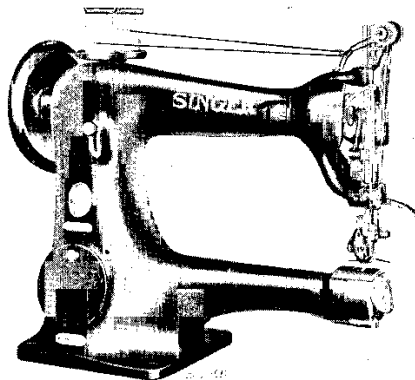

MACHINE No. 18-25

FOR SHOE VAMPING AND OTHER WORK IN LEATHER.  
TWO NEEDLES. TWO LONG BEAK SHUTTLES, 1/32  
INCH TO 1/4 INCH GAUGES. DROP FEED.  
ROLLER PRESSER. SPEED 1800 R. P. M.

| No.    | Plate | Name                                      |
|--------|-------|---|
| *16274 | ----  | Arm and Cylinder with 15404 and two 15405 |
| 16264  | 3699  | " Shaft.....                              |
| *16290 | ----  | " " 16264 with 3032, 16266 and 16269      |
| 3005   | 3698  | " " Bushing.....                          |
| 448C   | 3698  | " " " Set Screw.....                      |
| 16266  | 3698  | " " Counterbalance with 443C.....         |
| 443C   | 3698  | " " " Set Screw.....                      |
| 144D   | 3698  | " " Screw.....                            |
| 4288   | 22701 | " Side Cover (back).....                  |
| 51224W | 3698  | " " " Thumb Screw.....                    |
| 16102  | 22701 | " " " (front).....                        |
| 164J   | 3698  | " " " Screw.....                          |

## PARTS FOR MACHINE No. 18-25

| No.    | Plate | Name  |
|--------|-------|---|
| 2415   | 22701 | Arm Spool Bracket.....  |
| 15063  | 22701 | " " " 2415 with two 52239....   |
| 145J   | 3698  | " " " Screw.....  |
| 52239  | 3698  | " " " Spool Pin and Thread<br>Eyelet.....                                     |
| 11241  | 3692  | Arm Spool Bracket Spool Pin Washer (cloth)                                    |
| 16267  | 3699  | Balance Wheel (disc) for Power Table,<br>2-3/4 in. pulley, with two 448C..... |
| 16278  | 3699  | Balance Wheel (disc) for Stand, 3 in. pul-<br>ley, for Clamp Stop Motion..... |
| 448C   | 3698  | Balance Wheel Set Screw.....  |
| 256J   | 3698  | Clamp Stop Motion Clamp Screw.....  |
| 248A   | 3698  | " " " Stop Screw.....   |
| 202C   | 3698  | " " " Washer.....   |
| *3023  | ----  | " " " Flanged Bushing.....  |
| 4933   | 3698  | " " " " 3023 with<br>two 462C.....  |
| 2022   | 22702 | Clamp Stop Motion Flanged Bushing Pin....                                     |
| 462C   | 22702 | " " " " " Set Screw   |
| 3022   | ----  | Clamp Stop Motion complete, Nos. 248A, 256J<br>202C and 4933.....             |
| 6716   | 3699  | Cloth Plate.....  |
| 6719   | 3699  | " " Bracket with 345C.....  |
| 345C   | 22702 | " " " Set Screw.....  |
| 389F   | 22702 | " " Screw.....  |
| 6718   | 3699  | " " Slide.....  |
| 3286   | 22702 | " " " Spring.....   |
| 725J   | 22702 | " " " " Screw.....  |
| 6717   | 3699  | Cloth Plate complete, Nos. 3286, 6716,<br>6718 and two 725J.....              |
| 6702   | ----  | Cloth Plate with Bracket complete, Nos.<br>6717, 6719 and two 389F.....       |
| 4292   | 3683  | Crank Connecting Rod with two 145E.....                                       |
| 145E   | 3698  | " " " Cap Screw.....  |
| 375C   | 22702 | " " " Hinge Screw.....  |
| 1518J  | 22702 | " " " " Nut.....  |
| 16045  | 22702 | Cylinder Oil Tube for oiling Oscillating<br>Shaft.....                        |
| 16036  | 22701 | Cylinder Side Cover.....  |
| 51224W | 3698  | " " " Thumb Screw.....  |
| 3032   | 22702 | Feed Cam with 446C.....   |
| 446C   | 22702 | " " Set Screw.....  |
| 52165  | 22702 | " Connecting Link.....  |
| 375C   | 22702 | " " " Hinge Screw.....  |
| 1518J  | 22702 | " " " " Nut.....  |
| 16018  | 22704 | " Dog, for 1/32 in. to 5/64 in. gauges,<br>for 16153.....                     |
| 6677   | 22704 | Feed Dog, for 3/32 in. to 1/4 in. gauges,<br>for 16153.....                   |
| 6458   | 22704 | Feed Dog Carrier.....   |

| No.   | Plate | Name  |
|---|-------|---|
| 231C  | 22704 | Feed Dog Screw.....   |
| 3037  | 3683  | " Forked Connection.....  |
| 375C  | 22702 | " " " Hinge Screw.....  |
| 1518J   | 22702 | " " " " " Nut....   |
| 16177   | ----- | Feed Forked Connection complete, Nos.3037<br>16241, 52165 and two each 375C and<br>1518J..... |
| 6459  | 22702 | Feed Regulator.....   |
| 16241   | ----- | " " 6459 with 818D.....   |
| 58E   | 22704 | " " Hinge Screw.....  |
| 818D  | 22702 | " " Thumb Screw.....  |
| 6678  | 22703 | " Rock Shaft.....   |
| 16219   | ----- | " " " 6678 with 6458.....   |
| 6018  | 22704 | " " " Crank with 207F.....  |
| 156F  | 22704 | " " " " Position Screw....  |
| 207F  | 22704 | " " " " Set Screw.....  |
| 16275   | 22703 | Needle Bar (hollow).....  |
| 16276   | ----- | " " 16275 with 2273 and 4783, for<br>1/32 in. to 5/64 in. gauges.....                         |
| 16277   | ----- | Needle Bar 16275 with 2273 and 6524, for<br>3/32 in. to 1/4 in. gauges.....                   |
| *3045   | 22705 | Needle Bar Connecting Link.....   |
| 16220   | ----- | " " " " 3045 with 377C,<br>1518J and 6487.....  |
| 377C  | 22705 | Needle Bar Connecting Link Hinge Screw...   |
| 1518J   | 22702 | " " " " Nut   |
| 6487  | 22705 | " " " Stud with 155C....  |
| 155C  | 22705 | " " " Set Screw....   |
| 3214  | 22705 | " " Guide with 400C and 453C.....   |
| 400C  | 22705 | " " Adjusting Screw.....  |
| 453C  | 22705 | " " " Set Screw.....  |
| 290E  | 22705 | " " Screw Bushing.....  |
| 4783  | 22705 | " Clamp with two 336F.....  |
| Note: When ordering No. 4783, state gauge required. |       |   |
| 6524  | 22705 | Needle Clamp with two 50014F, for 3/32<br>in. to 1/4 in. gauges.....                          |
| 2273  | 22705 | Needle Clamp Pin.....   |
| 336F  | 22705 | " Set Screw, for 4783.....  |
| 50014F  | 22705 | " " " " 6524.....   |
| *16111  | 22701 | Oscillating Rock Shaft.....   |
| 16112   | ----- | Oscillating Rock Shaft complete, Nos.4784,<br>16111 and 16212.....                            |
| 6489  | 3683  | Oscillating Rock Shaft Hinge Pin.....   |
| *16212  | ----- | " " " " 6489 with<br>1513J.....   |
| 1513J   | 22705 | Oscillating Rock Shaft Hinge Pin Nut....  |
| 4784  | 22705 | " " " Oil Pad.....  |
| 16113   | 22703 | " Shaft.....  |
| *16221  | ----- | " " 16113 with 2049,16193<br>and 16213.....   |
| 16115   | ----- | Oscillating Shaft Crank for 16116.....  |

| No.        | Plate | Name  |
|------------|-------|---|
| *16192     | ----- | Oscillating Shaft Crank for 16193.....  |
| 16116      | 22705 | Oscillating Shaft Crank complete, Nos.<br>1518J, 16115, 19390 and two 462C....                              |
| *16193     | ----- | Oscillating Shaft Crank complete, Nos.<br>462C, 1518J, 16192 and 19390.....                                 |
| 2049       | 22705 | Oscillating Shaft Crank Pin.....  |
| 462C       | 22702 | " " " Set Screw.....  |
| 19389      | 22705 | " " " Slide Block.....  |
| 226J       | 22705 | " " " " " Cap<br>Screw.....   |
| 12424      | 22705 | Oscillating Shaft Crank Slide Block Cap<br>Screw Washer.....  |
| 969C       | 22705 | Oscillating Shaft Crank Slide Block Screw<br>Stud.....  |
| 1518J      | 22702 | Oscillating Shaft Crank Slide Block Screw<br>Stud Nut.....  |
| 19390      | ----- | Oscillating Shaft Crank Slide Block com-<br>plete, Nos. 226J, 969C, 12424 and<br>19389.....                 |
| 16145      | 22703 | Presser Bar (hollow).....   |
| 6464       | 3683  | " " Lifter.....   |
| 77J        | 22706 | " " " Screw.....  |
| 6465       | 22706 | " " " Washer.....   |
| 16197      | 22706 | " " Lifting Bracket with 175J and<br>two 457K.....  |
| 16198      | ----- | Presser Bar Lifting Bracket 16197 with<br>16196 and two 335J.....   |
| 175J       | 22706 | Presser Bar Lifting Bracket Adjusting<br>Screw.....   |
| 6469       | 3683  | Presser Bar Lifting Bracket Guide .....   |
| 175J       | 22706 | " " " " " Screw..   |
| 457K       | 22706 | " " " " " Set Screw...  |
| 16196      | 3683  | " " " " " Wearing Plate   |
| 335J       | 22706 | " " " " " " "   |
| Screw..... |       |   |
| 921E       | 22706 | Presser Bar Screw Bushing.....  |
| 16156      | 22706 | " " Spring (light) .065" wire....   |
| 16147      | ----- | " " " (heavy) .063" wire....  |
| 11170      | 22706 | " " " Washer.....   |
| 16148      | 22706 | " " Stop Collar with 1019C.....   |
| 1019C      | 22706 | " " " " Set Screw.....  |
| 688J       | 22706 | Pressure Regulating Thumb Screw.....  |
| 1958       | 22707 | Roller, 1-1/2 in. diam., 3/16 in. face,<br>coarse, with 1261D and 1528J, for<br>16071 and 16082.....        |
| 1875       | 22707 | Roller, 1-1/2 in. diam., 7/32 in. face,<br>diagonal knurl, with 634D and 1528J,<br>for 16014 and 16017..... |

## PARTS FOR MACHINE No. 18-25

| No.   | Plate | Name   |
|-------|-------|--|
| 51834 | 22708 | Roller, 1-1/2 in. diam., 3/16 in. face, coarse (ball bearing) complete for 16234 and 16235, Nos. 1528J, 1766C, 50553C and twenty-four 16232.....       |
| 51855 | 22708 | Roller, 1-1/2 in. diam., 3/16 in. face, coarse (ball bearing) complete for 16237, Nos. 1528J, 1766C, 50553C and twenty-four 16232.....                 |
| 51905 | 22708 | Roller, 1-1/2 in. diam., 1/4 in. face, medium (ball bearing) with ratchet brake complete for 16260, Nos. 1528J, 1766C, 50553C and twenty-four 16232..  |
| 51911 | 22709 | Roller, 1-1/2 in. diam., 3/16 in. face, medium (ball bearing) with ratchet brake complete for 16261, Nos. 1528J, 1766C, 50553C and twenty-four 16232.. |
| 6535  | 22707 | Roller Arm for 16014 and 16082.....  |
| 16015 | 22707 | " " " 16017 and 16071.....   |
| 16231 | 22708 | " " " 16234, 16235 and 16237....   |
| 16259 | 22708 | " " " 16260 and 16261.....   |
| 440F  | 3689  | " " Adjusting Screw.....   |
| 1547J | 3689  | " " " Nut.....   |
| 4785  | 22707 | " " Bracket for 16014, 16082, 16234, 16237, 16260 and 16261.....   |
| 19200 | 22707 | Roller Arm Bracket for 16017, 16071 and 16235.....   |
| 7556  | 22709 | Roller Arm Lock Spring.....  |
| 176J  | 3689  | " " " " Screw.....   |
| 1549J | 3689  | " " " " Nut.....   |
| 316F  | 3689  | " " " " Screw Center.....  |
| 15444 | ----- | " " " " 316F with 1547J..  |
| 1547J | 3689  | " " " " Nut.....   |
| 16232 | 3689  | " " Ball, size 3/32 in. for 51834, 51855, 51905 and 51911.....   |
| 1766C | 3689  | Roller Ball Retaining Nut for 51834, 51855, 51905 and 51911.....   |
| 16010 | 22709 | Roller Needle Guard (flat) for 16014.....  |
| 16080 | ----- | " " " " 16082, 16234, 16237, 16260 and 16261.....  |
| 207F  | 22704 | Roller Needle Guard (flat) Screw for 16014, 16082, 16234, 16237, 16260 and 16261.....  |
| 16013 | 22709 | Roller Needle Guard (round) for 16014....  |
| 16016 | 22709 | " " " " 16017, 16071 and 16235.....  |
| 16081 | ----- | Roller Needle Guard (round) for 16082, 16234, 16237, 16260 and 16261.....  |
| 16138 | 22709 | Roller Needle Guard (round) with 242J and 16139, for 16014.....  |

## PARTS FOR MACHINE No. 18-25

| No.    | Plate | Name  |
|--------|-------|---|
| 16139  | 22709 | Roller Needle Guard (round) Edge Guide, for 16138.....  |
| 242J   | 22709 | Roller Needle Guard (round) Edge Guide Screw.....   |
| 171F   | 22709 | Roller Needle Guard (round) Set Screw....   |
| 62853  | 3689  | " " Ratchet Spring Stop, for 62854....  |
| 62851  | 3689  | " " " " Bracket, for 62854.....   |
| 62854  | ----- | Roller Ratchet Spring Stop Bracket 62851 with 665J and 62853, for 16260 and 16261.....  |
| 230F   | 3689  | Roller Ratchet Spring Stop Bracket Screw, for 16260 and 16261.....  |
| 665J   | 3689  | Roller Ratchet Spring Stop Screw for 62854.....   |
| 634D   | 22709 | Roller Screw, for 1875.....   |
| 1261D  | 22709 | " " " 1958.....   |
| 50553C | 3689  | " " " 51834, 51855, 51905 and 51911.....  |
| 1528J  | 3689  | Roller Screw Nut.....   |
| 16082  | 22707 | Roller Presser complete, 1-1/2 in. diam., 3/16 in. face, for 1/32 in. to 5/64 in. gauges, Nos. 171F, 176J, 207F, 440F, 1547J, 1549J, 1958, 4785, 6535, 7556, 16080, 16081 and two 15444....                   |
| 16014  | 22707 | Roller Presser complete, 1-1/2 in. diam., 7/32 in. face, for 1/32 in. to 1/16 in. gauges, Nos. 171F, 176J, 207F, 440F, 1547J, 1549J, 1875, 4785, 6535, 7556, 16010, 16013 and two 15444....                   |
| 16071  | 22707 | Roller Presser complete, 1-1/2 in. diam., 3/16 in. face, for 3/32 in. to 1/4 in. gauges, Nos. 171F, 176J, 440F, 1547J, 1549J, 1958, 7556, 16015, 16016, 19200 and two 15444.....                              |
| 16017  | 22707 | Roller Presser complete, 1-1/2 in. diam., 7/32 in. face, for 3/32 in. to 1/4 in. gauges, Nos. 171F, 176J, 440F, 1547J, 1549J, 1875, 7556, 16015, 16016, 19200 and two 15444.....                              |
| 16234  | 22708 | Roller Presser (ball bearing) complete, 1-1/2 in. diam., 3/16 in. face, for 1/32 in. to 5/64 in. gauges, Nos. 171F, 176J, 207F, 440F, 1547J, 1549J, 4785, 7556, 16080, 16081, 16231, 51834 and two 15444..... |

| No.    | Plate | Name   |
|--------|-------|--|
| 16235  | 22708 | Roller Presser (ball bearing) complete, 1-1/2 in. diam., 3/16 in. face, for 3/32 in. to 1/4 in. gauges, Nos. 171F, 176J, 440F, 1547J, 1549J, 7556, 18016, 16231, 19200, 51834 and two 15444...   |
| 16237  | 22708 | Roller Presser (ball bearing) complete, 1-1/2 in. diam., 3/16 in. face, for 1/32 in. to 5/64 in. gauges, Nos. 171F, 176J, 207F, 440F, 1547J, 1549J, 4785, 7556, 16080, 16081, 16231, 51855 and two 15444.....                                  |
| 16260  | 22708 | Roller Presser (ball bearing) complete, 1-1/2 in. diam., 1/4 in. face, with ratchet brake, for 1/32 in. to 5/64 in. gauges, Nos. 171F, 176J, 207F, 230F, 440F, 1547J, 1549J, 4785, 7556, 16080, 16081, 16259, 51905, 62854 and two 15444.....  |
| 16261  | 22709 | Roller Presser (ball bearing) complete, 1-1/2 in. diam., 3/16 in. face, with ratchet brake, for 1/32 in. to 5/64 in. gauges, Nos. 171F, 176J, 207F, 230F, 440F, 1547J, 1549J, 4785, 7556, 16080, 16081, 16259, 51911, 62854 and two 15444..... |
| 190J   | 22704 | Roller Presser Screw.....  |
| 2210   | 22706 | Shuttle (inside) Bobbin.....   |
| 3230   | 22706 | " " " Retaining Spring   |
| 2212   | 3689  | " " " " Rivet.....   |
| *3235  | ----- | Shuttle (inside) Body with 398E, 2084, 3230, 3240 and two 2212.....  |
| *16205 | ----- | Shuttle (inside) Cover.....  |
| 2076   | 3689  | " " " Hinge Pin.....   |
| 2078   | 3689  | " " " Delivery Eye Thread Guard.....   |
| 2080   | 3689  | Shuttle (inside) Delivery Eye Thread Guard Rivet.....  |
| 3240   | 22706 | Shuttle (inside) Main Spring.....  |
| 398E   | 3689  | " " " " Screw.....   |
| 2084   | 3689  | " " " " Steady Pin.  |
| 466H   | 3689  | " " " Tension Regulating Screw.....  |
| 2086   | 3689  | Shuttle (inside) Tension Spring.....   |
| 2090   | 3689  | " " " " Plate...   |
| 112E   | 3689  | " " " " " Screw.....   |

| No.    | Plate | Name   |
|--------|-------|--|
| 16206  | 22706 | Shuttle (inside) closed eye complete, for 1/32 in. to 1/4 in. gauges, Nos. 112E, 466H, 2076, 2078, 2080, 2086, 2090, 2210, 3235 and 16205.....   |
| 2210   | 22706 | Shuttle (outside) Bobbin.....  |
| 3230   | 22706 | " " " Retaining Spring.  |
| 2212   | 3689  | " " " " Rivet.....   |
| *3232  | ----- | Shuttle (outside) Body with 398E, 2084, 3230, 3239 and two 2212, for 16209...  |
| *3383  | ----- | Shuttle (outside) Body with 398E, 2084, 3230, 3239 and two 2212, for 16208...  |
| *16207 | ----- | Shuttle (outside) Cover.....   |
| 2076   | 3689  | " " " Hinge Pin.....   |
| 3238   | 22706 | " " " Delivery Eye Thread Guard.....   |
| 2080   | 3689  | Shuttle (outside) Delivery Eye Thread Guard Rivet.....   |
| 3239   | 22706 | Shuttle (outside) Main Spring.....   |
| 398E   | 3689  | " " " " Screw.....   |
| 2084   | 3689  | " " " " Steady Pin.  |
| 466H   | 3689  | " " " Tension Regulating Screw.....  |
| 3241   | 22706 | Shuttle (outside) Tension Spring.....  |
| 3242   | 22706 | " " " " Plate...   |
| 112E   | 3689  | " " " " " Screw  |
| 16209  | 22710 | Shuttle (outside) closed eye complete, for 1/32 in. to 5/64 in. gauges, Nos. 112E, 466H, 2076, 2080, 2210, 3232, 3238, 3241, 3242 and 16207..... |
| 16208  | 22710 | Shuttle (outside) closed eye complete, for 3/32 in. to 1/4 in. gauges, Nos. 112E, 466H, 2076, 2080, 2210, 3238, 3241, 3242, 3383 and 16207.....  |
| 16213  | 22710 | Shuttle Driver and Feed Lifting Cam.....   |
| 2049   | 22705 | " " " " Pin..  |
| 16166  | ----- | " Race Body (two pieces) with either 813D, 814D or 815D, for 6746..  |
| 16238  | 22713 | Shuttle Race Body (two pieces) with either 813D, 814D or 815D, for 16239.  |
| 16103  | 22713 | Shuttle Race Cap.....  |
| 102J   | 22710 | " " " Screw.....   |
| 813D   | 22710 | " " " Hinge Screw, for 1/32 in. to 1/8 in. gauges.....   |
| 814D   | 22710 | Shuttle Race Hinge Screw, for 9/64 in. to 5/32 in. gauges.....   |
| 815D   | 22710 | Shuttle Race Hinge Screw, for 3/16 in. to 1/4 in. gauges.....  |

## PARTS FOR MACHINE No. 18-25

| No.   | Plate | Name   |
|---|-------|--|
| 6709  | 22710 | Shuttle Race Lock Pin.....   |
| Note: When ordering No. 6709, state gauge of Shuttle Race for which it is required. |       |  |
| 16101   | 22710 | Shuttle Race Lock Pin Bushing.....   |
| 6758  | 22713 | " " " " Spring.....  |
| 102J  | 22710 | " " " " " Screw.....   |
| 6746  | ----- | Shuttle Race complete, for 3/32 in. to 1/4 in. gauges, Nos. 6709, 6758, 16166 and two 102J.....    |
| 16239   | 22713 | Shuttle Race complete, for 1/32 in. to 5/64 in. gauges, Nos. 6709, 6758, 16238 and two 102J.....   |
| 738D  | 22710 | Shuttle Race Screw.....  |
| 16136   | 22713 | Tension and Needle Bar Guide Bracket....   |
| 16137   | ----- | Tension and Needle Bar Guide Bracket complete, Nos. 16136, two each 2103, 33929 and four 2102..... |
| 190J  | 22704 | Tension and Needle Bar Guide Bracket Screw.....  |
| 2102  | 3686  | Tension Disc.....  |
| 1560C   | 3686  | " Regulating Thumb Nut.....  |
| 6600  | 22711 | " Releaser.....  |
| 16149   | 22711 | " " Bracket with two 465C....  |
| 465C  | 22711 | " " Set Screw.....   |
| 207J  | 22704 | " " Screw.....   |
| 637C  | 22711 | " Screw Stud.....  |
| 33929   | ----- | " " 637C with 1560C.....   |
| 2103  | 3686  | " Spring.....  |
| 2413  | 22711 | " Thread Eyelet (double).....  |
| 330J  | 22711 | " " " Screw.....   |
| *16269  | ----- | Thread Take-up Cam.....  |
| 16270   | 3692  | " " " 16269 with 446C.....   |
| 3012  | 22711 | " " " Pin.....   |
| 446C  | 22702 | " " " Set Screw.....   |
| *6704   | 22711 | " " Lever with 1819.....   |
| 16181   | ----- | " " " 6704 with 76F.....   |
| 76F   | 3686  | " " " Hinge Screw.....   |
| 1819  | 3686  | " " " Roller and Stud.....   |
| 2410  | 22711 | " " " Roller.....  |
| 86D   | 22711 | " " " Screw.....   |
| 2411  | 22711 | " " " Stud.....  |
| 175F  | 22706 | " " " Set Screw.....   |
| 6603  | 22711 | " " Spring.....  |
| 6477  | 3686  | " " Regulator Plate....  |
| 233J  | 22705 | " " " " Ad-justing Screw.....  |
| 6602  | 22711 | Thread Take-up Spring Thread Guard and Thread Eyelet.....  |
| 219J  | 3686  | Thread Take-up Spring Thread Guard and Thread Eyelet Screw.....                                    |

## PARTS FOR MACHINE No. 18-25

| No.    | Plate | Name  |
|--------|-------|---|
| 16151  | 22704 | Throat Plate Body.....  |
| 16152  | 22704 | " " Needle Plate.....   |
| 228D   | 22704 | " " " " Screw.....  |
| 16153  | 22704 | Throat Plate complete for 16018, for 1/32 in. to 5/64 in. gauges, and for 6677, for 3/32 in. to 1/4 in. gauges, Nos. 228D, 16151 and 16152..... |
| 691D   | 22704 | Throat Plate Screw.....   |
| 16077  | 3693  | Drip Pan.....   |
| *15404 | ----- | Trade Mark.....   |
| 15405  | ----- | " " Rivet.....  |

Genuine Singer Needles should be used in Singer Machines. These Needles and their Containers are marked with the Company's Trade Mark "SIMANCO." 1

Needles in Containers marked "For Singer Machines" are not Singer made needles. 2

## MACHINE BASE

| No.   | Plate | Name   |
|-------|-------|--|
| 16031 | 3693  | Machine Base with four each 121E and wood screws 1-1/4 in. No. 12..... |
| 121E  | 22711 | Machine Screw, to secure machine to base.                              |

## ATTACHMENTS AND ACCESSORIES

| No.    | Plate | Name  |
|--------|-------|---|
| 51072E | 22712 | Machine Bolt with 51581E, to secure machine to table..... |
| 51581E | 22712 | Machine Bolt Nut.....                                     |
| 6055   | 22711 | " " " Washer.....   |
| 120342 | 22714 | Oiler (copper plated) with 120343.....                    |
| 120343 | 22714 | " Spout, 3-1/2 in. long.....                              |
| 26026  | 22714 | Screw Driver (machine).....                               |
| 26485  | 22714 | " " (shuttle tension).....                                |
| 8908   | 22714 | Wrench for 1520.....                                      |
| 8909   | 22714 | " " 1513, 1518 and 51581.....                             |
| 4822   | 22714 | " " 1528, 1547 and 1549.....                              |

## BOBBIN WINDER

(SWINGING AUTOMATIC, LEFT HAND)

| No.    | Plate | Name   |
|--------|-------|--|
| 16271  | 3692  | Base.....  |
| 27321  | 3692  | Frame.....   |
| 50356D | 3686  | " Hinge Screw.....   |
| 1620J  | 3686  | " " " Nut.....   |
| 27322  | 22712 | " Spring.....  |
| 27541  | 3692  | Pulley.....  |
| 27305  | 3692  | Spindle.....   |
| 27306  | 3692  | Spool Pin.....   |
| 27307  | 3692  | " Stand.....   |
| 27308  | 3692  | Spool Stand complete, Nos. 418E, 1562J, 2106, 10141, 11241, 27306, 27307 and two each 2455 and wood screws 1 in. No. 10..... |
| 11241  | 3692  | Spool Washer (cloth).....  |
| 27326  | 22712 | Stop Latch.....  |
| 35D    | 3686  | " " Hinge Screw.....   |
| 2455   | 22711 | Tension Disc.....  |
| 1562J  | 22712 | " Regulating Thumb Nut.....  |
| 418E   | 22712 | " Screw Stud.....  |

## BOBBIN WINDER

| No.   | Plate | Name  |
|-------|-------|---|
| 10141 | 22712 | Tension Spring.....   |
| 2106  | 3686  | " Thread Guide.....   |
| 16272 | ----- | Bobbin Winder, Nos. 35D, 1620J, 16271, 27305, 27321, 27322, 27326, 27541, 50356D and two wood screws 1 in. No. 7 F.H..... |
| 16273 | ----- | Bobbin Winder complete, Nos. 16272 and 27308.....   |

## FOOT LIFTER PARTS

| No.   | Plate | Name  |
|---|-------|---|
| 6439  | ----- | Chain, 36 in. to 45 in., with 56864 and 56865.....                              |
| Note: When ordering No. 6439, give length required. |       |   |
| 4879  | 3692  | Chain Connecting Link.....  |
| 56864   | 3692  | " Hook (large).....   |
| 56865   | 3692  | " " (small).....  |
| 6692  | 3691  | Lifting Lever.....  |
| 802D  | 22712 | " " Hinge Screw.....  |
| 16130   | 3691  | " " Spring.....   |
| 4881  | 3691  | Treadle.....  |
| 4882  | 3692  | " Shaft.....  |
| 4883  | 3692  | " Spring.....   |
| 4884  | 3691  | " Stand.....  |
| 4885  | 3691  | Treadle complete, Nos. 4879, 4881 to 4884 and two wood screws 1 in. No. 16..... |
| 6698  | ----- | Foot Lifter complete, Nos. 802D, 4885, 6439, 6692 and 16130.....                |

## KNEE LIFTER PARTS

(POWER TABLE OR STAND)

| No.   | Plate | Name   |
|-------|-------|--|
| 6692  | 3691  | Lifting Lever.....   |
| 802D  | 22712 | " " Hinge Screw.....   |
| 16130 | 3691  | " Spring.....  |
| 6703  | 3691  | Pitman, length 14-1/8 in. for 6691.....                          |
| 7898  | 3691  | " " 19 in., for 16154.....                                       |
| 7124  | 3691  | Rock Shaft.....  |
| 2764  | 3691  | " " Hanger (back) with two wood screws 1 in. No. 10.....         |
| 16128 | 3691  | Rock Shaft Hanger (front) with two wood screws 1 in. No. 10..... |
| 16646 | 3691  | Rock Shaft Knee Arm.....   |

## KNEE LIFTER PARTS

| No.   | Plate | Name  |
|-------|-------|---|
| 16647 | ----- | Rock Shaft Knee Arm complete, Nos. 2766, 2767 and 16646.....                          |
| 2766  | 3691  | Rock Shaft Knee Arm Hub with 356C.....  |
| 356C  | 22712 | " " " " " Set Screw.....  |
| 2767  | 3691  | " " " " " Plate with 356C.....  |
| 356C  | 22712 | " " " " " Set Screw.....  |
| 6337  | 3691  | " " " " " Lifting Bracket with two 356C.  |
| 6338  | 3691  | " " " " " Hook.....   |
| 356C  | 22712 | " " " " " Set Screw.....  |
| 356C  | 22712 | " " " " " Set Screw.....  |
| 2770  | 3691  | " " " " " Stop Dog with 356C.....   |
| 356C  | 22712 | " " " " " Set Screw.....  |
| 16129 | 3691  | Rock Shaft complete, Nos. 2764, 6337, 6338, 7124, 16128, 16647 and two 2770.....      |
| 6691  | ----- | Knee Lifter complete, Nos. 802D, 6692, 6703, 16129 and 16130.....                     |
| 16154 | ----- | Knee Lifter complete for Machine on Base, Nos. 802D, 6692, 7898, 16129 and 16130..... |

## THREAD LUBRICATORS

## THREAD LUBRICATOR No. 16248

FOR MACHINE No. 18-23

| No.    | Plate | Name  |
|--------|-------|---|
| 16247  | 3691  | Arm Side Cover (front).....   |
| 62819  | 22712 | Thread Lubricator Oil Pad (felt).....   |
| 62822  | ----- | Thread Lubricator Oil Pad Holder complete                                     |
| 62824  | 22712 | " " " " " Retainer.....   |
| 62827  | ----- | " " " " " Wick (braided cotton).....  |
| 50222J | 22712 | Thread Lubricator Screw.....  |
| 21202  | 22712 | " " " " " Friction Washer..   |
| 1529E  | 22712 | " " " " " Nut.....  |
| 62828  | ----- | Thread Lubricator complete.....   |
| 62829  | 3691  | " " " " " 62828 with 1529E, 50222J and two 21202.....                         |
| 16248  | 3691  | Arm Side Cover (front) with Thread Lubricator complete, Nos. 16247 and 62829. |

## THREAD LUBRICATOR No. 16254

FOR MACHINE No. 18-25

| No.   | Plate | Name                                     |
|-------|-------|--|
| 16249 | 22712 | Thread Lubricator Bracket Extension..... |

## THREAD LUBRICATOR No. 16254

| No.    | Plate | Name   |
|--------|-------|--|
| 50222J | 22712 | Thread Lubricator Bracket Screw.....                         |
| 21202  | 22712 | " " " " " Friction Washer.....                               |
| 1529E  | 22712 | Thread Lubricator Bracket Screw Nut.....                     |
| 241755 | 22712 | " " " " " Oil Pad (felt).....                                |
| 16251  | ----- | Thread Lubricator Oil Pad Holder complete                    |
| 241757 | 22712 | " " " " " Retainer.....                                      |
| 62827  | ----- | " " " " " Wick (braided cotton).....                         |
| 16253  | ----- | Thread Lubricator complete.....                              |
| 16254  | 22713 | " " " " " 16253 with 1529E, 16249, 50152J and two 21202..... |
| 50152J | 22712 | Thread Lubricator Screw.....                                 |

Genuine Singer Needles should be used in Singer Machines. These Needles and their Containers are marked with the Company's Trade Mark "SIMANCO." 1

Needles in Containers marked "For Singer Machines" are not Singer made needles. 2



## NUMERICAL LIST OF PARTS

| No.  | Plate | Name   |
|------|-------|--|
| 35D  | 3686  | Bobbin Winder Stop Latch Hinge Screw, for 16272.....   |
| 58E  | 22704 | Feed Regulator Hinge Screw.....  |
| 76F  | 3686  | Thread Take-up Lever Hinge Screw, for 16180 and 16181.....   |
| 77J  | 22706 | Presser Bar Lifter Screw.....  |
| 86D  | 22711 | Thread Take-up Roller Screw, for 18-25 Machine.....  |
| 102J | 22710 | Shuttle Race Cap Screw, for 18-25 Machine  |
| 102J | 22710 | " " Lock Pin Spring Screw, for 6746 and 16239.....   |
| 112E | 3689  | Shuttle Tension Spring Plate Screw, for 44001.....   |
| 112E | 3689  | Shuttle (inside) Tension Spring Plate Screw, for 16206.....  |
| 112E | 3689  | Shuttle (outside) Tension Spring Plate Screw, for 16208 and 16209.....   |
| 121E | 22711 | Machine Screw, to secure machine to base, for 16031.....   |
| 144D | 3698  | Arm Shaft Screw.....   |
| 145J | 3698  | " Spool Bracket Screw, for 18-25 Machine   |
| 145E | 3698  | Crank Connecting Rod Cap Screw, for 4292..   |
| 155C | 22705 | Needle Bar Connecting Stud Set Screw, for 6487.....  |
| 156F | 22704 | Feed Rock Shaft Crank Position Screw....   |
| 164J | 3698  | Arm Side Cover (front) Screw.....  |
| 171F | 22709 | Roller Needle Guard (round) Set Screw, for 16014, 16017, 16071, 16082, 16234, 16235, 16237, 16260 and 16261.....   |
| 175J | 22706 | Presser Bar Lifting Bracket Adjusting Screw, for 16194 and 16197.....  |
| 175J | 22706 | Presser Bar Lifting Bracket Guide Screw..  |
| 175J | 22706 | Tension Screw Stud Set Screw, for 18-23 Machine.....   |
| 175F | 22706 | Thread Take-up Roller Stud Set Screw, for 18-25 Machine.....   |
| 176J | 3689  | Roller Arm Lock Spring Screw, for 2196, 2197, 16014, 16017, 16071, 16082, 16099, 16100, 16225, 16226, 16228, 16233 to 16237, 16258, 16260, 16261, 65041, 65047, 65086, 65097, 65099 to 65101, 65123 and 65126..... |
| 190J | 22704 | Presser Foot Screw, for 18-23 Machine....  |
| 190J | 22704 | Roller Presser Screw.....  |
| 190J | 22704 | Tension and Needle Bar Guide Bracket Screw, for 18-25 Machine.....   |

**Genuine Singer Needles should be used  
in Singer Machines.  
These Needles and their Containers  
are marked with the  
Company's Trade Mark "SIMANCO." 1**

**Needles in Containers marked  
"For Singer Machines"  
are not Singer made needles. 2**

## NUMERICAL LIST OF PARTS

| No.  | Plate | Name   |
|------|-------|--|
| 207F | 22704 | Feed Rock Shaft Crank Set Screw, for 6018  |
| 207F | 22704 | " Wheel Driver Spring Screw, for 18-23 Machine.....  |
| 207F | 22704 | Feed Wheel Friction Spring Screw, for 18-23 Machine.....   |
| 207F | 22704 | Roller Needle Guard (flat) Screw, for 16014, 16082, 16234, 16237, 16260 and 16261.....                         |
| 207J | 22704 | Tension Releaser Screw, for 18-25 Machine  |
| 219J | 3686  | " Thread Guard Screw, for 18-23 Machine.....   |
| 219J | 3686  | Thread Take-up Spring Thread Guard and Thread Eyelet Screw, for 18-25 Machine                                  |
| 226J | 22705 | Oscillating Shaft Crank Slide Block Cap Screw, for 19390.....  |
| 228D | 22704 | Throat Plate Needle Plate Screw, for 16153   |
| 230F | 3689  | Roller Ratchet Spring Stop Bracket Screw, for 16258, 16260, 16261, 65097, 65099 to 65101, 65123 and 65126..... |
| 231C | 22704 | Feed Dog Screw, for 18-25 Machine.....   |
| 233J | 22705 | Needle Bar Thread Guide Screw, for 18-23 Machine.....  |
| 233J | 22705 | Thread Take-up Spring Regulator Plate Adjusting Screw.....   |
| 242J | 22709 | Roller Needle Guard (round) Edge Guide Screw, for 16138.....   |
| 248A | 3698  | Clamp Stop Motion Clamp Stop Screw, for 3022.....  |
| 256J | 3698  | Clamp Stop Motion Clamp Screw, for 3022..  |
| 262J | 3683  | Pressure Regulating Thumb Screw, for 18-23 Machine.....  |
| 290E | 22705 | Needle Bar Screw Bushing.....  |
| 290E | 22705 | Presser Bar Screw Bushing, for 18-23 Machine.....  |
| 316F | 3689  | Roller Arm Screw Center, for 15444.....  |
| 330J | 22711 | Tension Thread Eyelet Screw, for 18-25 Machine.....  |
| 335J | 22706 | Presser Bar Lifting Bracket Wearing Plate Screw, for 16195 and 16198.....                                      |
| 336F | 22705 | Needle Set Screw, for 4783.....  |
| 345C | 22702 | Cloth Plate Bracket Set Screw, for 6083 and 6719.....  |
| 356C | 22712 | Rock Shaft Knee Arm Hub Set Screw, for 2766.....   |
| 356C | 22712 | Rock Shaft Knee Plate Set Screw, for 2767  |
| 356C | 22712 | " " Lifting Bracket Hook Set Screw for 6337.....   |
| 356C | 22712 | Rock Shaft Lifting Bracket Set Screw, for 6337.....  |

## NUMERICAL LIST OF PARTS

| No.  | Plate | Name  |
|------|-------|---|
| 356C | 22712 | Rock Shaft Stop Dog Set Screw, for 2770..   |
| 375C | 22702 | Crank Connecting Rod Hinge Screw.....   |
| 375C | 22702 | Feed Connecting Link Hinge Screw.....   |
| 375C | 22702 | " Forked Connection Hinge Screw, for 16177.....   |
| 377C | 22705 | Needle Bar Connecting Link Hinge Screw, for 16220.....  |
| 386D | 3689  | Roller Screw, for 1839, 1869, 1897 and 1898.....  |
| 389F | 22702 | Cloth Plate Screw, for 6494 and 6702.....   |
| 398E | 3689  | Shuttle Main Spring Screw, for 6058.....  |
| 398E | 3689  | " (inside) Main Spring Screw, for 3235.....   |
| 398E | 3689  | Shuttle (outside) Main Spring Screw, for 3232 and 3383.....   |
| 399J | 22711 | Throat Ring Screw, for 18-23 Machine.....   |
| 400C | 22705 | Needle Bar Guide Adjusting Screw, for 3214.....   |
| 418E | 22712 | Bobbin Winder Tension Screw Stud, for 27308.....  |
| 440F | 3689  | Roller Arm Adjusting Screw, for 2196, 2197 16014, 16017, 16071, 16082, 16099, 16100, 16225, 16226, 16228, 16233 to 16237, 16258, 16260, 16261, 65041, 65047, 65086, 65097, 65099 to 65101, 65123 and 65126..... |
| 443C | 3698  | Arm Shaft Counterbalance Set Screw, for 16266.....  |
| 446C | 22702 | Feed Cam Set Screw, for 3032.....   |
| 446C | 22702 | " Eccentric Set Screw, for 3074.....  |
| 446C | 22702 | Thread Take-up Cam Set Screw, for 16270..   |
| 448C | 3698  | Arm Shaft Bushing Set Screw.....  |
| 448C | 3698  | Balance Wheel Set Screw, for 16267.....   |
| 453C | 22705 | Needle Bar Guide Set Screw, for 3214.....   |
| 457K | 22706 | Presser Bar Lifting Bracket Set Screw, for 16194 and 16197.....   |
| 460C | 22705 | Oscillating Shaft Crank Set Screw, for 6056.....  |
| 462C | 22702 | Clamp Stop Motion Flanged Bushing Set Screw, for 4933.....  |
| 462C | 22702 | Oscillating Shaft Crank Set Screw, for 6024, 16116 and 16193.....   |
| 465C | 22711 | Tension Releaser Bracket Set Screw, for 16149.....  |
| 466H | 3689  | Shuttle Tension Regulating Screw, for 44001.....  |
| 466H | 3689  | Shuttle (inside) Tension Regulating Screw for 16206.....  |
| 466H | 3689  | Shuttle (outside) Tension Regulating Screw, for 16208 and 16209.....  |

## NUMERICAL LIST OF PARTS

| No.   | Plate | Name  |
|-------|-------|---|
| 600C  | 3686  | Tension Screw Stud, for 16202.....  |
| 634D  | 22709 | Roller Screw, for 1875.....   |
| 637C  | 22711 | Tension Screw Stud, for 33929.....  |
| 652D  | 3689  | Roller Screw, for 1841, 1868 and 1923....   |
| 665J  | 3689  | " Ratchet Spring Stop Screw, for 62854.....   |
| 665J  | 3689  | Throat Ring Needle Plate Screw, for 16244   |
| 688J  | 22706 | Pressure Regulating Thumb Screw, for 18-25 Machine.....   |
| 691D  | 22704 | Throat Plate Screw, for 18-25 Machine....   |
| 725J  | 22702 | Cloth Plate Slide Spring Screw, for 6495 and 6717.....  |
| 725J  | 22702 | Shuttle Race Ring Latch Screw, for 6500..   |
| 738D  | 22710 | " Screw, for 18-25 Machine....  |
| 802D  | 22712 | Lifting Lever Hinge Screw, for 6891, 6898 and 16154.....  |
| 808F  | 22705 | Needle Clamp Screw, for 4303.....   |
| 813D  | 22710 | Shuttle Race Hinge Screw, for 1/32 in. to 1/8 in. gauges, for 16166 and 16238..   |
| 814D  | 22710 | Shuttle Race Hinge Screw, for 9/64 in. to 5/32 in. gauges, for 16166 and 16238..  |
| 815D  | 22710 | Shuttle Race Hinge Screw, for 3/16 in. to 1/4 in. gauges, for 16166 and 16238..   |
| 818D  | 22702 | Feed Regulator Thumb Screw, for 16241....   |
| 921E  | 22706 | Presser Bar Screw Bushing, for 18-25 Machine.....   |
| 969C  | 22705 | Oscillating Shaft Crank Slide Block Screw Stud, for 19390.....  |
| 1019C | 22706 | Presser Bar Stop Collar Set Screw, for 16148.....   |
| 1253C | 3686  | Tension Releaser Collar Set Screw, for 16240.....   |
| 1261D | 22709 | Roller Screw, for 1958.....   |
| 1513J | 22705 | Oscillating Rock Shaft Hinge Pin Nut, for 16212.....  |
| 1518J | 22702 | Crank Connecting Rod Hinge Screw Nut....  |
| 1518J | 22702 | Feed Connecting Link Hinge Screw Nut....  |
| 1518J | 22702 | " Forked Connection Hinge Screw Nut, for 16177.....   |
| 1518J | 22702 | Needle Bar Connecting Link Hinge Screw Nut, for 16220.....  |
| 1518J | 22702 | Oscillating Shaft Crank Slide Block Screw Stud Nut, for 16116 and 16193.....  |
| 1528J | 3689  | Roller Screw Nut, for 1839, 1841, 1868, 1869, 1875, 1897, 1898, 1923, 1958, 51832, 51834, 51841, 51849, 51851, 51855, 51860, 51892, 51904 to 51906, 51911, 51913, 51915, 51921 and 51922. |
| 1529E | 22712 | Thread Lubricator Bracket Screw Nut, for 16254.....   |

## NUMERICAL LIST OF PARTS

| No.   | Plate | Name   |
|-------|-------|--|
| 1529E | 22712 | Thread Lubricator Screw Nut, for 62829...  |
| 1547J | 3689  | Roller Arm Adjusting Screw Nut, for 2196, 2197, 16014, 16017, 16071, 16082, 16099, 16100, 16225, 16226, 16228, 16233 to 16237, 16258, 16260, 16261, 65041, 65047, 65086, 65097, 65099 to 65101, 65123 and 65126..... |
| 1547J | 3689  | Roller Arm Screw Center Nut, for 15444...  |
| 1549J | 3689  | " " Lock Spring Screw Nut for 2196 2197, 16014, 16017, 16071, 16082, 16099, 16100, 16225, 16226, 16228, 16233 to 16237, 16258, 16260, 16261, 65041, 65047, 65086, 65097, 65099 to 65101, 65123 and 65126.....        |
| 1560C | 3686  | Tension Regulating Thumb Nut, for 16202 and 33929.....   |
| 1562J | 22712 | Bobbin Winder Tension Regulating Thumb Nut, for 27308.....   |
| 1620J | 3686  | Bobbin Winder Frame Hinge Screw Nut, for 16272.....  |
| 1766C | 3689  | Roller Ball Retaining Nut, for 51832, 51834, 51841, 51849, 51851, 51855, 51860, 51892, 51904 to 51906, 51911, 51913, 51915, 51921 and 51922.....   |
| 1813  | 22705 | Oscillating Shaft Crank Roller and Stud, for 6024 and 6056.....  |
| 1819  | 3686  | Thread Take-up Lever Roller and Stud, for 6474 and 6704.....   |
| 1839  | 3681  | Roller, 1-1/4 in. diam., 9/64 in. face, coarse, with 386D and 1528J, for 16099   |
| 1841  | 3681  | Roller, 7/8 in. diam., 9/64 in. face, fine with 652D and 1528J, for 2197.....  |
| 1868  | 3681  | Roller, 7/8 in. diam., 9/64 in. face, coarse, with 652D and 1528J, for 2196.   |
| 1869  | 3682  | Roller, 1-1/4 in. diam., 9/64 in. face, fine, with 386D and 1528J, for 16100.  |
| 1875  | 22707 | Roller, 1-1/2 in. diam., 7/32 in. face, diagonal knurl, with 634D and 1528J, for 16014 and 16017.....  |
| 1897  | 3682  | Roller, 1-1/4 in. diam., 3/16 in. face, coarse, with 386D and 1528J, for 16225   |
| 1898  | 3682  | Roller, 1-1/4 in. diam., 3/16 in. face, fine, with 386D and 1528J, for 16226.  |
| 1923  | 3681  | Roller, 1-1/4 in. diam., 1/8 in. face, coarse, with 652D and 1528J, for 16228  |
| 1958  | 22707 | Roller, 1-1/2 in. diam., 3/16 in. face, coarse, with 1261D and 1528J, for 16071 and 16082.....   |
| 2020  | 3698  | Clamp Stop Motion Clamp Washer, for 3022.  |

## NUMERICAL LIST OF PARTS

| No.   | Plate | Name   |
|-------|-------|--|
| 2022  | 22702 | Clamp Stop Motion Flanged Bushing Pin....  |
| 2049  | 22705 | Oscillating Shaft Crank Pin, for 16184 and 16221.....  |
| 2049  | 22705 | Shuttle Driver and Feed Lifting Cam Pin, for 18-25 Machine.....  |
| 2049  | 22705 | Shuttle Driver Pin, for 18-23 Machine....  |
| 2070  | 22706 | Presser Bar Spring Washer, for 18-23 Machine.....  |
| 2073  | 3689  | Shuttle Bobbin, for 6028.....  |
| *2075 | ----- | " Cover, for 44001.....  |
| 2076  | 3689  | " " Hinge Pin, for 6028.....   |
| 2076  | 3689  | " (inside) Cover Hinge Pin, for 16206.....   |
| 2076  | 3689  | Shuttle (outside) Cover Hinge Pin, for 16208 and 16209.....  |
| 2078  | 3689  | Shuttle Delivery Eye Thread Guard, for 44001.....  |
| 2078  | 3689  | Shuttle (inside) Delivery Eye Thread Guard, for 16206.....   |
| 2080  | 3689  | Shuttle Delivery Eye Thread Guard Rivet, for 44001.....  |
| 2080  | 3689  | Shuttle (inside) Delivery Eye Thread Guard Rivet, for 16206.....   |
| 2080  | 3689  | Shuttle (outside) Delivery Eye Thread Guard Rivet, for 16208 and 16209.....  |
| 2082  | 3689  | Shuttle Main Spring, for 6058.....   |
| 2084  | 3689  | " " Steady Pin, for 6058   |
| 2084  | 3689  | " (inside) Main Spring Steady Pin, for 3235.....   |
| 2084  | 3689  | Shuttle (outside) Main Spring Steady Pin, for 3232 and 3383.....   |
| 2086  | 3689  | Shuttle Tension Spring, for 44001.....   |
| 2086  | 3689  | " (inside) Tension Spring, for 16206   |
| 2090  | 3689  | " Tension Spring Plate, for 44001..  |
| 2090  | 3689  | " (inside) Tension Spring Plate, for 16206.....  |
| 2102  | 3686  | Tension Disc, for 16137 and 16204.....   |
| 2103  | 3686  | " Spring, for 16137 and 16204.....   |
| 2106  | 3686  | Bobbin Winder Tension Thread Guide, for 27308.....   |
| 2106  | 3686  | Thread Eyelet (front of arm) for 18-23 Machine.....  |
| 2180  | 22704 | Presser Foot, for 18-23 Machine.....   |
| 2196  | 3681  | Roller Presser complete, 7/8 in. diam., 9/64 in. face, coarse roller, for 18-23 Machine, Nos. 176J, 440F, 1547J 1549J, 1868, 2203, 2205, 2206 and two 15444..... |

## NUMERICAL LIST OF PARTS

| No.   | Plate | Name   |
|-------|-------|--|
| 2197  | 3681  | Roller Presser complete, 7/8 in. diam., 9/64 in. face, fine roller, for 18-23 Machine, Nos. 176J, 440F, 1547J, 1549J 1841, 2203, 2205, 2206 and two 15444. |
| 2203  | 3681  | Roller Arm, for 2196 and 2197.....   |
| 2205  | 3689  | " " Lock Spring, for 2196, 2197, 16099, 16100, 16225, 16226, 16228, 16233, 16236, 16258, 65041, 65047, 65086, 65097, 65099 to 65101, 65123 and 65126.....  |
| 2206  | 3681  | Roller Arm Bracket, for 2196 and 2197....  |
| 2210  | 22706 | Shuttle (inside) Bobbin, for 16206.....  |
| 2210  | 22706 | " (outside) Bobbin, for 16208 and 16209.....   |
| 2211  | 3689  | Shuttle Bobbin Retaining Spring, for 6058.   |
| 2212  | 3689  | " " Rivet, for 6058.....   |
| 2212  | 3689  | Shuttle (inside) Bobbin Retaining Spring Rivet, for 3235.....  |
| 2212  | 3689  | Shuttle (outside) Bobbin Retaining Spring Rivet, for 3232 and 3383.....  |
| 2273  | 22705 | Needle Clamp Pin, for 16276 and 16277....  |
| 2410  | 22711 | Thread Take-up Roller, for 18-25 Machine.  |
| 2411  | 22711 | " Stud, for 18-25 Machine.....   |
| 2413  | 22711 | Tension Thread Eyelet (double) for 18-25 Machine.....  |
| 2415  | 22701 | Arm Spool Bracket, for 15063.....  |
| 2455  | 22711 | Bobbin Winder Tension Disc, for 27308....  |
| 2764  | 3691  | Rock Shaft Hanger (back) with two wood screws 1 in. No. 10, for 16129.....   |
| 2766  | 3691  | Rock Shaft Knee Arm Hub with 356C, for 16647.....  |
| 2767  | 3691  | Rock Shaft Knee Plate with 356C, for 16647   |
| 2770  | 3691  | " " Stop Dog with 356C, for 16129.   |
| 3005  | 3698  | Arm Shaft Bushing.....   |
| 3012  | 22711 | Thread Take-up Cam Pin.....  |
| 3022  | ----- | Clamp Stop Motion complete, Nos. 248A, 256J, 2020 and 4933.....  |
| *3023 | ----- | Clamp Stop Motion Flanged Bushing, for 4933.....   |
| 3032  | 22702 | Feed Cam with 448C, for 16290.....   |
| 3037  | 3683  | " Forked Connection, for 16177.....  |
| *3045 | 22705 | Needle Bar Connecting Link, for 16220....  |
| 3054  | 3683  | Presser Bar, for 18-23 Machine.....  |
| 3074  | 22702 | Feed Eccentric with 448C, for 16281.....   |
| 3214  | 22705 | Needle Bar Guide with 400C and 453C, for 18-25 Machine.....  |
| 3230  | 22706 | Shuttle (inside) Bobbin Retaining Spring, for 3235.....  |

## NUMERICAL LIST OF PARTS

| No.   | Plate | Name   |
|-------|-------|--|
| 3230  | 22706 | Shuttle (outside) Bobbin Retaining Spring for 3232 and 3383.....   |
| *3232 | ----- | Shuttle (outside) Body with 398E, 2084, 3230, 3239 and two 2212, for 16209...  |
| *3235 | ----- | Shuttle (inside) Body with 398E, 2084, 3230, 3240 and two 2212, for 16206...   |
| 3238  | 22706 | Shuttle (outside) Delivery Eye Thread Guard, for 16208 and 16209.....  |
| 3239  | 22706 | Shuttle (outside) Main Spring, for 3232 and 3383.....  |
| 3240  | 22706 | Shuttle (inside) Main Spring, for 3235...  |
| 3241  | 22706 | Shuttle (outside) Tension Spring, for 16208 and 16209.....   |
| 3242  | 22706 | Shuttle (outside) Tension Spring Plate, for 16208 and 16209.....   |
| 3286  | 22702 | Cloth Plate Slide Spring, for 6495 and 6717.....   |
| *3383 | ----- | Shuttle (outside) Body with 398E, 2084, 3230, 3239 and two 2212, for 16208...  |
| 4282  | 3681  | Roller Arm Bracket, for 16099, 16100, 16225, 16226, 16228, 16233, 16236, 16258, 65041, 65047, 65086, 65097, 65099 to 65101, 65123 and 65126..... |
| 4288  | 22701 | Arm Side Cover (back).....   |
| 4292  | 3683  | Crank Connecting Rod with two 145E.....  |
| 4302  | 22705 | Needle Bar Thread Guide, for 18-23 Machine   |
| 4303  | 22705 | " Clamp with 808F, for 18-23 Machine   |
| 4783  | 22705 | " " " two 336F, for 16276....  |
| 4784  | 22705 | Oscillating Rock Shaft Oil Pad, for 6461 and 16112.....  |
| 4785  | 22707 | Roller Arm Bracket, for 16014, 16082, 16234, 16237, 16260 and 16261.....   |
| 4822  | 22714 | Wrench for 1528, 1547 and 1549 (Attachments and Accessories).....  |
| 4879  | 3692  | Foot Lifter Chain Connecting Link, for 4885.....   |
| 4881  | 3691  | Foot Lifter Treadle, for 4885.....   |
| 4882  | 3692  | " " " Shaft, for 4885.....   |
| 4883  | 3692  | " " " Spring, for 4885.....  |
| 4884  | 3691  | " " " Stand, for 4885.....   |
| 4885  | 3691  | Foot Lifter Treadle complete for 6698, Nos. 4879, 4881 to 4884 and two wood screws 1 in. No. 16.....   |
| 4933  | 3698  | Clamp Stop Motion Flanged Bushing 3023 with two 462C, for 3022.....  |
| 5459  | 3683  | Presser Bar Spring (light) .047" wire, for 18-23 Machine.....  |
| 6018  | 22704 | Feed Rock Shaft Crank with 207F.....   |
| 6024  | 22705 | Oscillating Shaft Crank with 1813 and two 462C, for 18-23 Machine.....   |

## NUMERICAL LIST OF PARTS

| No.   | Plate | Name  |
|-------|-------|---|
| 6028  | 3689  | Shuttle (high point) complete, for 18-23 Machine, Nos. 2073, 2076, 6058 and 44001.....  |
| 6055  | 22711 | Machine Bolt Nut Washer (Attachments and Accessories).....                              |
| *6056 | ----- | Oscillating Shaft Crank with 460C and 1813, for 16184.....                              |
| *6058 | ----- | Shuttle Body with 398E, 2082, 2084, 2211 and two 2212, for 6028.....                    |
| 6083  | 3699  | Cloth Plate Bracket with two 345C, for 6494.....  |
| 6337  | 3691  | Rock Shaft Lifting Bracket with two 356C, for 16129.....                                |
| 6338  | 3691  | Rock Shaft Lifting Bracket Hook, for 16129  |
| 6439  | ----- | Foot Lifter Chain, 36 in. to 45 in. with 56864 and 56865, for 6698.....                 |
| 6458  | 22704 | Feed Dog Carrier, for 16219.....  |
| 6459  | 22702 | " Regulator, for 16241.....   |
| *6461 | 22701 | Oscillating Rock Shaft with 4784, for 16176.....  |
| 6464  | 3683  | Presser Bar Lifter.....   |
| 6465  | 22706 | " " " Washer.....   |
| 6466  | ----- | " " " Spring (medium) .055" wire, for 18-23 Machine.....                                |
| 6467  | ----- | Presser Bar Spring (heavy) .063" wire, for 18-23 Machine.....                           |
| 6469  | 3683  | Presser Bar Lifting Bracket Guide.....  |
| 6472  | 22713 | Shuttle Race Ring Latch, for 6500.....  |
| *6474 | 3686  | Thread Take-up Lever with 1819, for 16180.  |
| 6477  | 3686  | " " " Spring Regulator Plate....  |
| 6487  | 22705 | Needle Bar Connecting Stud with 155C, for 16220.....                                    |
| 6488  | 22703 | Feed Rock Shaft, for 18-23 Machine.....   |
| 6489  | 3683  | Oscillating Rock Shaft Hinge Pin, for 16212.....  |
| 6494  | ----- | Cloth Plate with Bracket complete, for 18-23 Machine, Nos. 6083, 6495 and two 389F..... |
| 6495  | 3699  | Cloth Plate complete for 6494, Nos. 3286, 6496, 6786 and two 725J.....                  |
| 6496  | 3699  | Cloth Plate Slide, for 6495.....  |
| 6497  | 22701 | Feed Wheel, for 18-23 Machine.....  |
| 6498  | 22701 | " " " Driver, for 18-23 Machine....   |
| 6499  | 22710 | Shuttle Driver, for 16184.....  |
| 6500  | 22713 | Shuttle Race Ring complete for 16245, Nos. 6472, 16046 and two 725J.....                |
| 6524  | 22705 | Needle Clamp with two 50014F, for 3/32 in. to 1/4 in. gauges, for 16277.....            |
| 6535  | 22707 | Roller Arm, for 16014 and 16082.....  |

## NUMERICAL LIST OF PARTS

| No.   | Plate | Name  |
|-------|-------|---|
| 6600  | 22711 | Tension Releaser, for 18-25 Machine.....  |
| 6602  | 22711 | Thread Take-up Spring Thread Guard and Thread Eyelet, for 18-25 Machine.....                                    |
| 6603  | 22711 | Thread Take-up Spring, for 18-25 Machine.   |
| 6677  | 22704 | Feed Dog, for 3/32 in. to 1/4 in. gauges, for 16153, for 18-25 Machine.....                                     |
| 6678  | 22703 | Feed Rock Shaft, for 16219.....   |
| 6691  | ----- | Knee Lifter complete, Nos. 802D, 6692, 6703, 16129 and 16130.....   |
| 6692  | 3691  | Lifting Lever, for 6691, 6698 and 16154..   |
| 6698  | ----- | Foot Lifter complete, Nos. 802D, 4885, 6439, 6692 and 16130.....  |
| 6702  | ----- | Cloth Plate with Bracket complete, for 18-25 Machine, Nos. 6717, 6719 and two 389F.....                         |
| 6703  | 3691  | Pitman, length 14-1/8 in., for 6691.....  |
| *6704 | 22711 | Thread Take-up Lever with 1819, for 16181   |
| 6709  | 22710 | Shuttle Race Lock Pin, for 6746 and 16239   |
| 6716  | 3699  | Cloth Plate, for 6717.....  |
| 6717  | 3699  | Cloth Plate complete for 6702, Nos. 3286, 6716, 6718 and two 725J.....  |
| 6718  | 3699  | Cloth Plate Slide, for 6717.....  |
| 6719  | 3699  | " " Bracket with 345C, for 6702..   |
| 6746  | ----- | Shuttle Race complete, for 3/32 in. to 1/4 in. gauges, for 18-25 Machine, Nos. 6709, 6758, 16166 and two 102J.. |
| 6758  | 22713 | Shuttle Race Lock Pin Spring, for 6746 and 16239.....   |
| 6768  | 3686  | Thread Take-up Spring, for 18-23 Machine.   |
| 6786  | 3699  | Cloth Plate, for 6495.....  |
| 7124  | 3691  | Rock Shaft, for 16129.....  |
| 7393  | 3686  | Tension Releaser Collar Pin, for 16240...   |
| 7556  | 22709 | Roller Arm Lock Spring for 16014, 16017, 16071, 16082, 16234, 16235, 16237, 16260 and 16261.....                |
| 7898  | 3691  | Pitman, length 19 in., for 16154.....   |
| 8879  | 3698  | Arm Spool Pin Washer (cloth) for 18-23 Machine.....   |
| 8908  | 22714 | Wrench for 1520 (Attachments and Accessories).....  |
| 8909  | 22714 | Wrench for 1513, 1518 and 51581 (Attachments and Accessories).....  |
| 10141 | 22712 | Bobbin Winder Tension Spring, for 27308..   |
| 11170 | 22706 | Presser Bar Spring Washer, for 18-25 Machine.....   |
| 11241 | 3692  | Arm Spool Bracket Spool Pin Washer(cloth) for 18-25 Machine.....  |
| 11241 | 3692  | Bobbin Winder Spool Washer (cloth) for 27308.....   |

## NUMERICAL LIST OF PARTS

| No.    | Plate | Name  |
|--------|-------|---|
| 12424  | 22705 | Oscillating Shaft Crank Slide Block Cap Screw Washer, for 19390.....  |
| 15063  | 22701 | Arm Spool Bracket 2415 with two 52239, for 18-25 Machine.....   |
| *15404 | ----- | Trade Mark, for 16274 and 16280.....  |
| 15405  | ----- | " " Rivet, for 16274 and 16280...   |
| 15444  | ----- | Roller Arm Screw Center 316F with 1547J, for 2196, 2197, 16014, 16017, 16071, 16082, 16099, 16100, 16225, 16226, 16228, 16233 to 16237, 16258, 16260, 16261, 65041, 65047, 65086, 65097, 65099 to 65101, 65123 and 65126..... |
| 16010  | 22709 | Roller Needle Guard (flat) for 16014.....   |
| 16013  | 22709 | " " " (round) for 16014....   |
| 16014  | 22707 | Roller Presser complete, 1-1/2 in. diam., 7/32 in. face, for 1/32 in. to 1/16 in. gauges, for 18-25 Machine, Nos. 171F, 176J, 207F, 440F, 1547J, 1549J, 1875, 4785, 6535, 7556, 16010, 16013 and two 15444.....               |
| 16015  | 22707 | Roller Arm, for 16017 and 16071.....  |
| 16016  | 22709 | " Needle Guard (round) for 16017, 16071 and 16235.....  |
| 16017  | 22707 | Roller Presser complete, 1-1/2 in. diam., 7/32 in. face, for 3/32 in. to 1/4 in. gauges, for 18-25 Machine, Nos. 171F, 176J, 440F, 1547J, 1549J, 1875, 7556, 16015, 16016, 19200 and two 15444.....                           |
| 16018  | 22704 | Feed Dog, for 1/32 in. to 5/64 in. gauges for 16153, for 18-25 Machine.....   |
| 16022  | 3686  | Tension Thread Guard, for 18-23 Machine..   |
| 16031  | 3693  | Machine Base with four each 121E and wood screws 1-1/4 in. No. 12.....  |
| 16036  | 22701 | Cylinder Side Cover.....  |
| 16045  | 22702 | " Oil Tube, for oiling Oscillating Shaft.....   |
| 16046  | 22713 | Shuttle Race Ring, for 6500.....  |
| 16055  | 22703 | Oscillating Shaft, for 16184.....   |
| 16071  | 22707 | Roller Presser complete, 1-1/2 in. diam., 3/16 in. face, for 3/32 in. to 1/4 in. gauges, for 18-25 Machine, Nos. 171F, 176J, 440F, 1547J, 1549J, 1958, 7556, 16015, 16016, 19200 and two 15444.....                           |
| 16077  | 3693  | Drip Pan.....   |
| 16080  | ----- | Roller Needle Guard (flat) for 16082, 16234, 16237, 16260 and 16261.....  |
| 16081  | ----- | Roller Needle Guard (round) for 16082, 16234, 16237, 16260 and 16261.....   |

## NUMERICAL LIST OF PARTS

| No.    | Plate | Name  |
|--------|-------|---|
| 16082  | 22707 | Roller Presser complete, 1-1/2 in. diam., 3/16 in. face, for 1/32 in. to 5/64 in. gauges, for 18-25 Machine, Nos. 171F, 176J, 207F, 440F, 1547J, 1549J, 1958, 4785, 6535, 7556, 16080, 16081 and two 15444..... |
| 16098  | 3681  | Roller Arm, for 16099, 16100, 16225, 16226 and 16228.....   |
| 16099  | 3681  | Roller Presser complete, 1-1/4 in. diam., 9/64 in. face, coarse roller, for 18-23 Machine, Nos. 176J, 440F, 1547J, 1549J, 1839, 2205, 4282, 16098 and two 15444.....  |
| 16100  | 3682  | Roller Presser complete, 1-1/4 in. diam., 9/64 in. face, fine roller, for 18-23 Machine, Nos. 176J, 440F, 1547J, 1549J, 1869, 2205, 4282, 16098 and two 15444.....  |
| 16101  | 22710 | Shuttle Race Lock Pin Bushing, for 18-25 Machine.....   |
| 16102  | 22701 | Arm Side Cover (front).....   |
| 16103  | 22713 | Shuttle Race Cap, for 18-25 Machine.....  |
| *16111 | 22701 | Oscillating Rock Shaft, for 16112.....  |
| 16112  | ----- | Oscillating Rock Shaft complete for 18-25 Machine, Nos. 4784, 16111 and 16212..   |
| 16113  | 22703 | Oscillating Shaft, for 16221.....   |
| 16115  | ----- | " Crank, for 16116.....   |
| 16116  | 22705 | Oscillating Shaft Crank complete for 18-25 Machine, Nos. 1518J, 16115, 19390 and two 462C.....  |
| 16128  | 3691  | Rock Shaft Hanger (front) with two wood screws 1 in. No. 10, for 16129.....   |
| 16129  | 3691  | Rock Shaft complete for 6691 and 16154, Nos. 2764, 6337, 6338, 7124, 16128, 16647 and two 2770.....   |
| 16130  | 3691  | Lifting Lever Spring for 6691, 6698 and 16154.....  |
| 16136  | 22713 | Tension and Needle Bar Guide Bracket, for 16137.....  |
| 16137  | ----- | Tension and Needle Bar Guide Bracket complete for 18-25 Machine, Nos. 16136, two each 2103, 33929 and four 2102...  |
| 16138  | 22709 | Roller Needle Guard (round) with 242J and 16139, for 16014.....   |
| 16139  | 22709 | Roller Needle Guard (round) Edge Guide, for 16138.....  |
| 16145  | 22703 | Presser Bar (hollow) for 18-25 Machine...   |
| 16147  | ----- | " Spring (heavy) .063" wire, for 18-25 Machine.....   |
| 16148  | 22706 | Presser Bar Stop Collar with 1019C, for 18-25 Machine.....  |

## NUMERICAL LIST OF PARTS

| No.    | Plate | Name  |
|--------|-------|---|
| 16149  | 22711 | Tension Releaser Bracket with two 465C, for 18-25 Machine.....  |
| 16151  | 22704 | Throat Plate Body, for 16153.....   |
| 16152  | 22704 | " Needle Plate, for 16153.....  |
| 16153  | 22704 | Throat Plate complete for 16018, for 1/32 in. to 5/64 in. gauges and for 6677, for 3/32 in. to 1/4 in. gauges, for 18-25 Machine, Nos. 228D, 16151 and 16152..... |
| 16154  | ----- | Knee Lifter complete, for Machine on Base, Nos. 802D, 6692, 7898, 16129 and 16130.....  |
| 16156  | 22706 | Presser Bar Spring (light) .055" wire, for 18-25 Machine.....   |
| 16166  | ----- | Shuttle Race Body (two pieces) with either 813D, 814D or 815D, for 6746..   |
| 16168  | 22702 | Feed Wheel Driver Spring, for 18-23 Machine.....  |
| 16176  | ----- | Oscillating Rock Shaft complete, for 18-23 Machine, Nos. 6461 and 16212.....  |
| 16177  | ----- | Feed Forked Connection complete, Nos. 3037, 16241, 52165 and two each 375C and 1518J.....   |
| 16180  | ----- | Thread Take-up Lever 6474 with 76F, for 18-23 Machine.....  |
| 16181  | ----- | Thread Take-up Lever 6704 with 76F, for 18-25 Machine.....  |
| *16184 | ----- | Oscillating Shaft 16055 with 2049, 6056 and 6499, for 18-23 Machine.....  |
| *16192 | ----- | Oscillating Shaft Crank, for 16193.....   |
| *16193 | ----- | Oscillating Shaft Crank complete for 16221, Nos. 462C, 1518J, 16192 and 19390.....  |
| 16194  | 3683  | Presser Bar Lifting Bracket with 175J and two 457K, for 16195.....  |
| 16195  | 3683  | Presser Bar Lifting Bracket 16194 with 16196 and two 335J, for 18-23 Machine  |
| 16196  | 3683  | Presser Bar Lifting Bracket Wearing Plate for 16195 and 16198.....  |
| 16197  | 22706 | Presser Bar Lifting Bracket with 175J and two 457K, for 16198.....  |
| 16198  | ----- | Presser Bar Lifting Bracket 16197 with 16196 and two 335J, for 18-25 Machine  |
| 16202  | ----- | Tension Screw Stud 600C with 1560C, for 16204.....  |
| 16204  | ----- | Tension complete for 18-23 Machine, Nos. 2103, 16202 and two 2102.....  |
| *16205 | ----- | Shuttle (inside) Cover, for 16206.....  |

## NUMERICAL LIST OF PARTS

| No.    | Plate | Name  |
|--------|-------|---|
| 16206  | 22706 | Shuttle (inside) closed eye complete, for 1/32 in. to 1/4 in. gauges, for 18-25 Machine, Nos. 112E, 466H, 2076, 2078, 2080, 2086, 2090, 2210, 3235 and 16205                        |
| *16207 | ----- | Shuttle (outside) Cover, for 16208 and 16209.....   |
| 16208  | 22710 | Shuttle (outside) closed eye complete, for 3/32 in. to 1/4 in. gauges, for 18-25 Machine, Nos. 112E, 466H, 2076, 2080, 2210, 3238, 3241, 3242, 3383 and 16207                       |
| 16209  | 22710 | Shuttle (outside) closed eye complete, for 1/32 in. to 5/64 in. gauges, for 18-25 Machine, Nos. 112E, 466H, 2076, 2080, 2210, 3232, 3238, 3241, 3242 and 16207                      |
| *16212 | ----- | Oscillating Rock Shaft Hinge Pin 6489 with 1513J, for 16112 and 16176.....  |
| 16213  | 22710 | Shuttle Driver and Feed Lifting Cam, for 16221.....   |
| 16219  | ----- | Feed Rock Shaft 6678 with 6458, for 18-25 Machine.....  |
| 16220  | ----- | Needle Bar Connecting Link 3045 with 377C 1518J and 6487.....   |
| *16221 | ----- | Oscillating Shaft 16113 with 2049, 16193 and 16213, for 18-25 Machine.....  |
| 16225  | 3682  | Roller Presser complete, 1-1/4 in. diam., 3/16 in. face, coarse roller, for 18-23 Machine, Nos. 176J, 440F, 1547J 1549J, 1897, 2205, 4282, 16098 and two 15444.....                 |
| 16226  | 3682  | Roller Presser complete, 1-1/4 in. diam., 3/16 in. face, fine roller, for 18-23 Machine, Nos. 176J, 440F, 1547J, 1549J 1898, 2205, 4282, 16098 and two 15444                        |
| 16228  | 3681  | Roller Presser complete, 1-1/4 in. diam., 1/8 in. face, coarse roller, for 18-23 Machine, Nos. 176J, 440F, 1547J, 1549J 1923, 2205, 4282, 16098 and two 15444                       |
| 16230  | 3682  | Roller Arm, for 16233, 16236, 65041, 65047 and 65086.....   |
| 16231  | 22708 | Roller Arm, for 16234, 16235 and 16237...   |
| 16232  | 3689  | " Ball, size 3/32 in. for 51832, 51834, 51841, 51849, 51851, 51855, 51860, 51892, 51904 to 51906, 51911, 51913, 51915, 51921 and 51922.....   |
| 16233  | 3695  | Roller Presser (ball bearing) complete, 1-1/4 in. diam., 7/32 in. face, coarse roller, for 18-23 Machine, Nos. 176J, 440F, 1547J, 1549J, 2205, 4282, 16230 51832 and two 15444..... |

## NUMERICAL LIST OF PARTS

| No.   | Plate | Name  |
|-------|-------|---|
| 16234 | 22706 | Roller Presser (ball bearing) complete, 1-1/2 in. diam., 3/16 in. face, for 1/32 in. to 5/64 in. gauges, for 18-25 Machine, Nos. 171F, 176J, 207F, 440F, 1547J, 1549J, 4785, 7556, 16080, 16081 16231, 51834 and two 15444..... |
| 16235 | 22706 | Roller Presser (ball bearing) complete, 1-1/2 in. diam., 3/16 in. face, for 3/32 in. to 1/4 in. gauges, for 18-25 Machine, Nos. 171F, 176J, 440F, 1547J 1549J, 7556, 16016, 16231, 19200, 51834 and two 15444.....              |
| 16236 | 3682  | Roller Presser (ball bearing) complete, 1-1/4 in. diam., 5/32 in. face, coarse roller, for 18-23 Machine, Nos. 176J, 440F, 1547J, 1549J, 2205, 4282, 16230 51841 and two 15444.....   |
| 16237 | 22708 | Roller Presser (ball bearing) complete, 1-1/2 in. diam., 3/16 in. face, for 1/32 in. to 5/64 in. gauges, for 18-25 Machine, Nos. 171F, 176J, 207F, 440F, 1547J, 1549J, 4785, 7556, 16080, 16081 16231, 51855 and two 15444..... |
| 16238 | 22713 | Shuttle Race Body (two pieces) with either 813D, 814D or 815D, for 16239.   |
| 16239 | 22713 | Shuttle Race complete, for 1/32 in. to 5/64 in. gauges, for 18-25 Machine, Nos. 6709, 6758, 16238 and two 102J..  |
| 16240 | 3686  | Tension Releaser Collar with 7393 and two 1253C, for 18-23 Machine.....   |
| 16241 | ----- | Feed Regulator 6459 with 818D, for 16177.   |
| 16243 | 22713 | Throat Ring, for 16244.....   |
| 16244 | 22713 | " " 16243 with 665J and 16262, for 16245.....   |
| 16245 | ----- | Throat Ring complete for 18-23 Machine, Nos. 6500, 16244 and two 50008J.....  |
| 16246 | 22704 | Feed Wheel Friction Spring, for 18-23 Machine.....  |
| 16247 | 3691  | Arm Side Cover (front) for 16248.....   |
| 16248 | 3691  | Arm Side Cover (front) with Thread Lubricator complete, for 18-23 Machine, Nos. 16247 and 62829.....  |
| 16249 | 22712 | Thread Lubricator Bracket Extension, for 16254.....   |
| 16251 | ----- | Thread Lubricator Oil Pad Holder complete for 18-25 Machine.....  |
| 16253 | ----- | Thread Lubricator complete, for 16254....   |
| 16254 | 22713 | " " 16253 with 1529E, 16249 50152J and two 21202.....   |



## NUMERICAL LIST OF PARTS

| No.    | Plate | Name  |
|--------|-------|---|
| 16258  | 3697  | Roller Presser (ball bearing) complete, 1-1/4 in. diam., 7/32 in. face, grooved coarse, with ratchet brake, for 18-23 Machine, Nos. 176J, 230F, 440F, 1547J, 1549J, 2205, 4282, 51904 62854, 65095 and two 15444.....   |
| 16259  | 22708 | Roller Arm, for 16260 and 16261.....  |
| 16260  | 22708 | Roller Presser (ball bearing) complete, 1-1/2 in. diam., 1/4 in. face, with ratchet brake, for 1/32 in. to 5/64 in. gauges, for 18-25 Machines, Nos. 171F, 176J, 207F, 230F, 440F, 1547J, 1549J, 4785, 7556, 16080, 16081, 16259 51905, 62854 and two 15444.....  |
| 16261  | 22709 | Roller Presser (ball bearing) complete, 1-1/2 in. diam., 3/16 in. face, with ratchet brake, for 1/32 in. to 5/64 in. gauges, for 18-25 Machines, Nos. 171F, 176J, 207F, 230F, 440F, 1547J, 1549J, 4785, 7556, 16080, 16081, 16259 51911, 62854 and two 15444..... |
| 16262  | 22711 | Throat Ring Needle Plate, for 16244.....  |
| 16264  | 3699  | Arm Shaft, for 16281 and 16290.....   |
| 16266  | 3698  | " Counterbalance with 443C, for 16281 and 16290.....  |
| 16267  | 3699  | Balance Wheel (disc) for Power Table, 2-3/4 in. pulley, with two 448C.....  |
| 16268  | 3683  | Needle Bar (hollow) for 18-23 Machine....   |
| *16269 | ----- | Thread Take-up Cam, for 16270, 16281 and 16290.....   |
| 16270  | 3692  | Thread Take-up Cam 16269 with 446C.....   |
| 16271  | 3692  | Bobbin Winder Base, for 16272.....  |
| 16272  | ----- | " " for 16273, Nos. 35D, 1620J, 16271, 27305, 27321, 27322, 27326, 27541, 50356D and two wood screws 1 in. No. 7 F.H.....   |
| 16273  | ----- | Bobbin Winder (swinging automatic, left hand) complete, Nos. 16272 and 27308.....   |
| *16274 | ----- | Arm and Cylinder with 15404 and two 15405 for 18-25 Machine.....  |
| 16275  | 22703 | Needle Bar (hollow) for 16276 and 16277..   |
| 16276  | ----- | " " 16275 with 2273 and 4783, for 1/32 in. to 5/64 in. gauges, for 18-25 Machine.....   |
| 16277  | ----- | Needle Bar 16275 with 2273 and 6524, for 3/32 in. to 1/4 in. gauges, for 18-25 Machine.....   |
| 16278  | 3699  | Balance Wheel (disc) for Stand, 3 in. pulley, for Clamp Stop Motion.....  |

## NUMERICAL LIST OF PARTS

| No.    | Plate | Name   |
|--------|-------|--|
| 16279  | 3686  | Tension Releaser, for 18-23 Machine.....   |
| *16280 | ----- | Arm and Cylinder with 15404 and two 15405 for 18-23 Machine.....   |
| *16281 | ----- | Arm Shaft 16264 with 3074, 16266 and 16289 for 18-23 Machine.....  |
| *16290 | ----- | Arm Shaft 16264 with 3032, 16266 and 16289 for 18-25 Machine.....  |
| 16646  | 3691  | Rock Shaft Knee Arm, for 16647.....  |
| 16647  | ----- | Rock Shaft Knee Arm complete, for 16129, Nos. 2766, 2767 and 16646.....  |
| 19200  | 22707 | Roller Arm Bracket, for 16017, 16071 and 16235.....  |
| 19389  | 22705 | Oscillating Shaft Crank Slide Block, for 19390.....  |
| 19390  | ----- | Oscillating Shaft Crank Slide Block complete for 16116 and 16193, Nos. 226J, 969C, 12424 and 19389.....  |
| 21202  | 22712 | Thread Lubricator Bracket Screw Friction Washer, for 16254.....  |
| 21202  | 22712 | Thread Lubricator Screw Friction Washer, for 62829.....  |
| 26026  | 22714 | Screw Driver (machine) Attachments and Accessories.....  |
| 26485  | 22714 | Screw Driver (shuttle tension) Attachments and Accessories.....  |
| 27305  | 3692  | Bobbin Winder Spindle, for 16272.....  |
| 27306  | 3692  | " " Spool Pin, for 27308.....  |
| 27307  | 3692  | " " Stand, for 27308....   |
| 27308  | 3692  | Bobbin Winder Spool Stand complete for 16273, Nos. 418E, 1562J, 2106, 10141, 11241, 27306, 27307 and two each 2455 and wood screws 1 in. No. 10..... |
| 27321  | 3692  | Bobbin Winder Frame, for 16272.....  |
| 27322  | 22712 | " " Spring, for 16272...   |
| 27326  | 22712 | " " Stop Latch, for 16272.....   |
| 27541  | 3692  | " " Pulley, for 16272.....   |
| 33929  | ----- | Tension Screw Stud 637C with 1560C, for 16137.....   |
| *44001 | ----- | Shuttle Cover 2075 with 112E, 466H, 2078, 2080, 2086 and 2090, for 6028.....   |
| 50008J | 22710 | Shuttle Race Ring Screw, for 16245.....  |
| 50014F | 22705 | Needle Set Screw, for 6524.....  |
| 50116K | 3686  | Tension Releaser Screw, for 18-23 Machine  |
| 50152J | 22712 | Thread Lubricator Screw, for 16254.....  |
| 50222J | 22712 | " " Bracket Screw, for 18-25 Machine.....  |
| 50222J | 22712 | Thread Lubricator Screw, for 62829.....  |
| 50356D | 3686  | Bobbin Winder Frame Hinge Screw, for 16272   |

## NUMERICAL LIST OF PARTS

| No.    | Plate | Name   |
|--------|-------|--|
| 50553C | 3689  | Roller Screw, for 51832, 51834, 51841, 51849, 51851, 51855, 51860, 51892, 51904 to 51906, 51911, 51913, 51915, 51921 and 51922.....                                |
| 51072E | 22712 | Machine Bolt with 51581E, to secure machine to table (Attachments and Accessories).....  |
| 51224W | 3698  | Arm Side Cover (back) Thumb Screw.....   |
| 51224W | 3698  | Cylinder Side Cover Thumb Screw.....   |
| 51581E | 22712 | Machine Bolt Nut, for 51072.....   |
| 51832  | 3695  | Roller, 1-1/4 in. diam., 7/32 in. face, coarse (ball bearing) complete for 16233, Nos. 1528J, 1766C, 50553C and twenty-four 16232.....                             |
| 51834  | 22708 | Roller, 1-1/2 in. diam., 3/16 in. face, coarse (ball bearing) complete for 16234 and 16235, Nos. 1528J, 1766C, 50553C and twenty-four 16232.....                   |
| 51841  | 3682  | Roller, 1-1/4 in. diam., 5/32 in. face, coarse (ball bearing) complete for 16236, Nos. 1528J, 1766C, 50553C and twenty-four 16232.....                             |
| 51849  | 3695  | Roller, 1-1/4 in. diam., 3/16 in. face, coarse (ball bearing) complete for 65086, Nos. 1528J, 1766C, 50553C and twenty-four 16232.....                             |
| 51851  | 3695  | Roller, 1-1/4 in. diam., 3/16 in. face, fine (ball bearing) complete for 65047, Nos. 1528J, 1766C, 50553C and twenty-four 16232.....                               |
| 51855  | 22708 | Roller, 1-1/2 in. diam., 3/16 in. face, coarse (ball bearing) complete for 16237, Nos. 1528J, 1766C, 50553C and twenty-four 16232.....                             |
| 51860  | 3695  | Roller, 1-1/4 in. diam., 7/32 in. face, coarse (ball bearing) complete for 65041, Nos. 1528J, 1766C, 50553C and twenty-four 16232.....                             |
| 51892  | 3696  | Roller, 1-1/4 in. diam., 1/8 in. face, coarse (ball bearing) with ratchet brake complete, for 65099, Nos. 1528J, 1766C, 50553C and twenty-four 16232..             |
| 51904  | 3697  | Roller, 1-1/4 in. diam., 7/32 in. face, grooved coarse (ball bearing) with ratchet brake, complete for 16259, Nos. 1528J, 1766C, 50553C and twenty-four 16232..... |

## NUMERICAL LIST OF PARTS

| No.   | Plate | Name  |
|-------|-------|---|
| 51905 | 22708 | Roller, 1-1/2 in. diam., 1/4 in. face, medium (ball bearing) with ratchet brake, complete for 16260, Nos. 1528J, 1766C, 50553C and twenty-four 16232..  |
| 51906 | 3696  | Roller, 1-1/4 in. diam., 9/64 in. face, fine (ball bearing) with ratchet brake, complete for 65100, Nos. 1528J, 1766C, 50553C and twenty-four 16232..   |
| 51911 | 22709 | Roller, 1-1/2 in. diam., 3/16 in. face, medium (ball bearing) with ratchet brake, complete for 16261, Nos. 1528J, 1766C, 50553C and twenty-four 16232.. |
| 51913 | 3697  | Roller, 1-1/4 in. diam., 7/32 in. face, fine (ball bearing) with ratchet brake, complete for 65097, Nos. 1528J, 1766C, 50553C and twenty-four 16232..   |
| 51915 | 3696  | Roller, 1-1/4 in. diam., 7/32 in. face, coarse (ball bearing) with ratchet brake, complete for 65101, Nos. 1528J, 1766C, 50553C and twenty-four 16232.. |
| 51921 | 3697  | Roller, 1-1/4 in. diam., 7/32 in. face, medium (ball bearing) with ratchet brake, complete for 65123, Nos. 1528J, 1766C, 50553C and twenty-four 16232.. |
| 51922 | 3696  | Roller, 1-1/4 in. diam., 3/16 in. face, fine (ball bearing) with ratchet brake, complete for 65126, Nos. 1528J, 1766C, 50553C and twenty-four 16232..   |
| 52185 | 22702 | Feed Connecting Link, for 16177.....  |
| 52239 | 3698  | Arm Spool Bracket Spool Pin and Thread Eyelet, for 15063.....   |
| 52239 | 3698  | Arm Spool Pin and Thread Eyelet, for 18-23 Machine.....   |
| 56864 | 3692  | Foot Lifter Chain Hook (large) for 6439..   |
| 56865 | 3692  | " " " (small) for 6439..  |
| 62819 | 22712 | Thread Lubricator Oil Pad (felt) for 18-23 Machine.....   |
| 62822 | ----- | Thread Lubricator Oil Pad Holder complete for 18-23 Machine.....  |
| 62824 | 22712 | Thread Lubricator Oil Pad Retainer, for 18-23 Machine.....  |
| 62827 | ----- | Thread Lubricator Oil Wick (braided cotton).....  |
| 62828 | ----- | Thread Lubricator complete for 62829.....   |
| 62829 | 3691  | " " 62828 with 1529E, 50222J and two 21202, for 16248.....  |
| 62851 | 3689  | Roller Ratchet Spring Stop Bracket for 62854.....   |
| 62853 | 3689  | Roller Ratchet Spring Stop, for 62854....   |

## NUMERICAL LIST OF PARTS

| No.   | Plate | Name  |
|-------|-------|---|
| 62854 | ----- | Roller Ratchet Spring Stop Bracket 62851 with 665J and 62853, for 16258, 16260 16261, 65097, 65099 to 65101, 65123 and 65126.....   |
| 65041 | 3695  | Roller Presser (ball bearing) complete, 1-1/4 in. diam., 5/32 in. face, coarse roller, for 18-23 Machine, Nos. 176J, 440F, 1547J, 1549J, 2205, 4282, 16230, 51860 and two 15444.....                                |
| 65047 | 3695  | Roller Presser (ball bearing) complete, 1-1/4 in. diam., 3/16 in. face, fine roller, for 18-23 Machine, Nos. 176J, 440F, 1547J, 1549J, 2205, 4282, 16230, 51851 and two 15444.....                                  |
| 65086 | 3695  | Roller Presser (ball bearing) complete, 1-1/4 in. diam., 3/16 in. face, fine roller, for 18-23 Machine, Nos. 176J, 440F, 1547J, 1549J, 2205, 4282, 16230, 51849 and two 15444.....                                  |
| 65095 | 3696  | Roller Arm, for 16258, 65097, 65099, 65100 65101 and 65123.....   |
| 65097 | 3697  | Roller Presser (ball bearing) complete, 1-1/4 in. diam., 7/32 in. face, fine roller with ratchet brake, for 18-23 Machine, Nos. 176J, 230F, 440F, 1547J 1549J, 2205, 4282, 51913, 62854, 65095 and two 15444.....   |
| 65099 | 3696  | Roller Presser (ball bearing) complete, 1-1/4 in. diam., 1/8 in. face, coarse roller with ratchet brake, for 18-23 Machine, Nos. 176J, 230F, 440F, 1547J 1549J, 2205, 4282, 51892, 62854, 65095 and two 15444.....  |
| 65100 | 3696  | Roller Presser (ball bearing) complete, 1-1/4 in. diam., 9/64 in. face, fine roller with ratchet brake, for 18-23 Machine, Nos. 176J, 230F, 440F, 1547J 1549J, 2205, 4282, 51906, 62854, 65095 and two 15444.....   |
| 65101 | 3696  | Roller Presser (ball bearing) complete, 1-1/4 in. diam., 7/32 in. face, coarse roller with ratchet brake, for 18-23 Machine, Nos. 176J, 230F, 440F, 1547J 1549J, 2205, 4282, 51915, 62854, 65095 and two 15444..... |
| 65123 | 3697  | Roller Presser (ball bearing) complete, 1-1/4 in. diam., 7/32 in. face, medium roller with ratchet brake, for 18-23 Machine, Nos. 176J, 230F, 440F, 1547J 1549J, 2205, 4282, 51921, 62854, 65095 and two 15444..... |

## NUMERICAL LIST OF PARTS

| No.    | Plate | Name  |
|--------|-------|---|
| 65125  | 3696  | Roller Arm, for 65126.....  |
| 65126  | 3696  | Roller Presser (ball bearing) complete, 1-1/4 in. diam., 3/16 in. face, fine roller with ratchet brake, for 18-23 Machine, Nos. 176J, 230F, 440F, 1547J 1549J, 2205, 4282, 51922, 62854, 65125 and two 15444..... |
| 120342 | 22714 | Oiler (copper plated) with 120343 (Attachments and Accessories).....  |
| 120343 | 22714 | Oiler Spout, 3-1/2 in. long, for 120342..   |
| 241755 | 22712 | Thread Lubricator Oil Pad (felt) for 18-25 Machine.....   |
| 241757 | 22712 | Thread Lubricator Oil Pad Retainer, for 18-25 Machine.....  |

Genuine Singer Needles should be used  
in Singer Machines.  
These Needles and their Containers  
are marked with the  
Company's Trade Mark "SIMANCO." 1

Needles in Containers marked  
"For Singer Machines"  
are not Singer made needles. 2

PLATE 3681—FULL SIZE

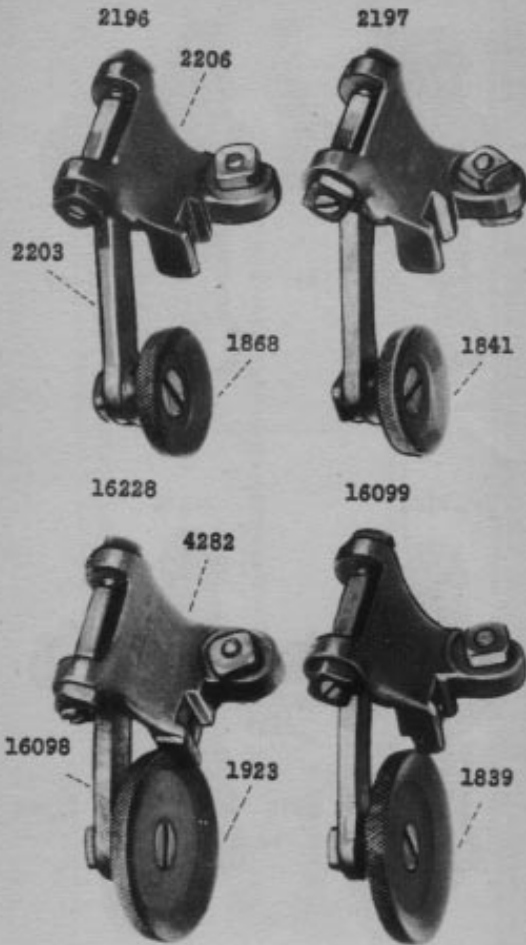
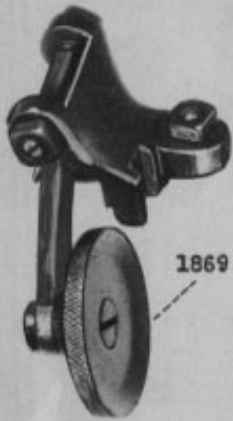

PLATE 3682—FULL SIZE

16100



1869

16225



1897

16226



1898

16236



16230

51841

PLATE 3683—ONE-HALF SIZE

4292



3037

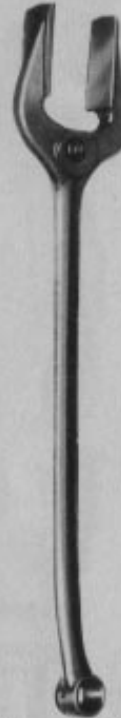

3054



16268



6489



5459



6464



16195



16194

6469



262



16196



PLATE 3686—FULL SIZE

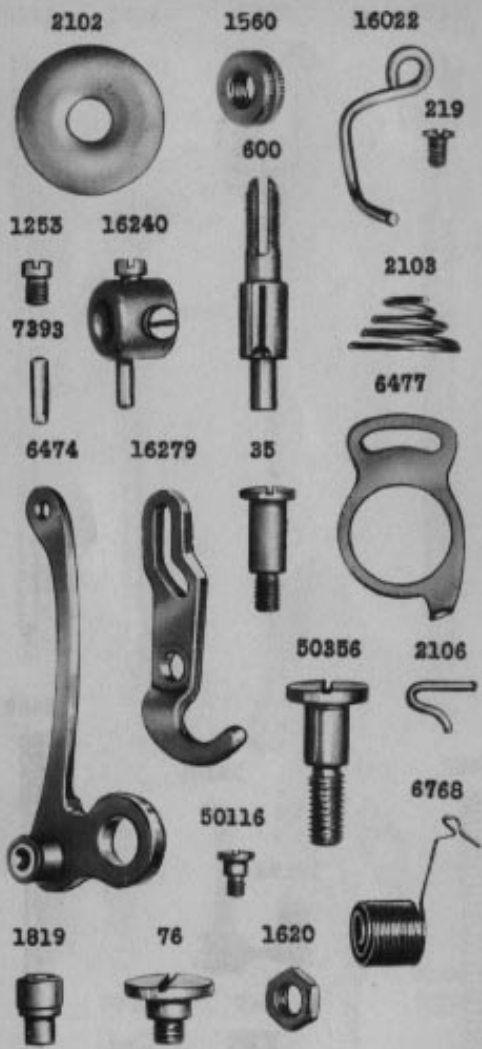

PLATE 3689—FULL SIZE

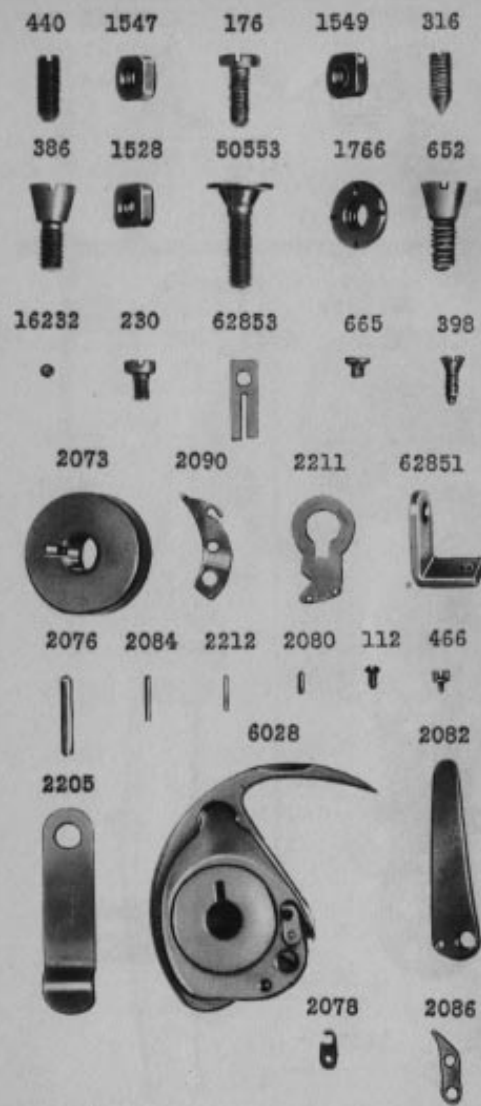

PLATE 3691—ONE-FOURTH SIZE

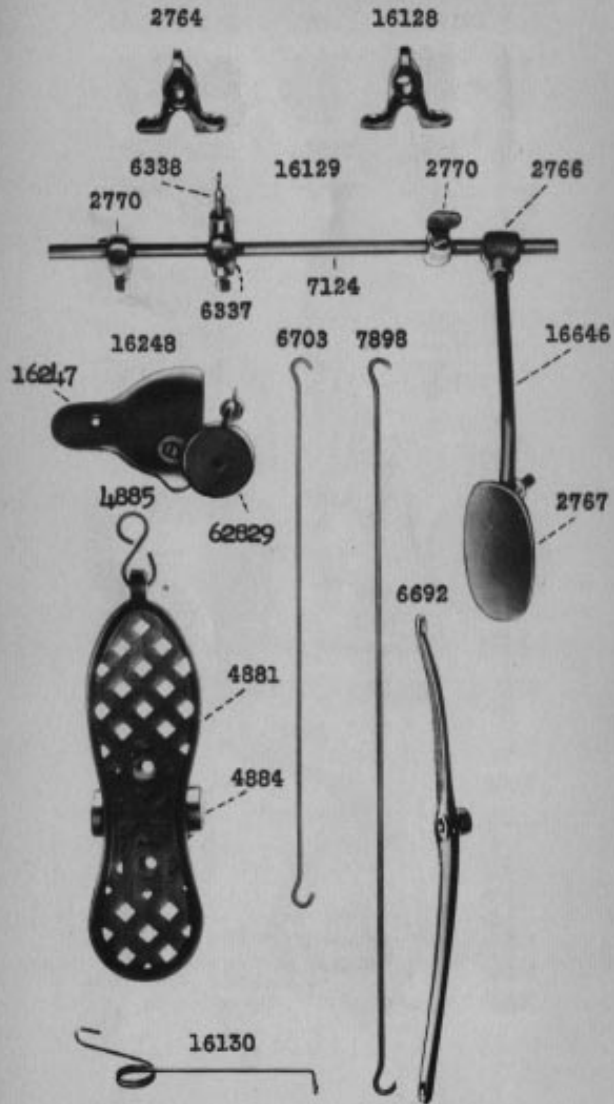

PLATE 3692—ONE-HALF SIZE

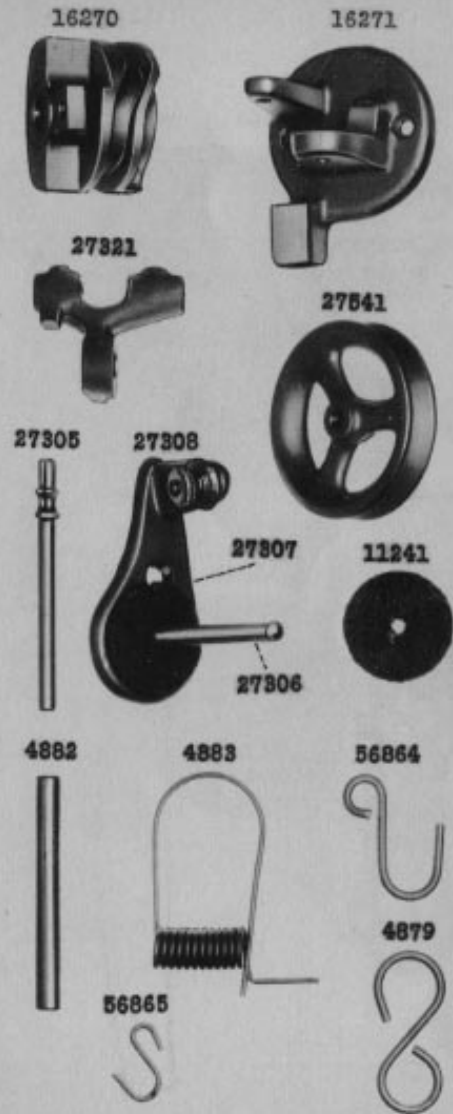
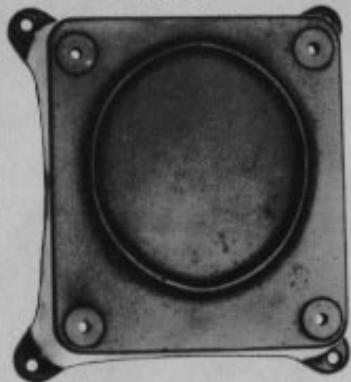

PLATE 3693—ONE-FOURTH SIZE

16031



16077



PLATE 3695—FULL SIZE

65086



65047



65041



16233





PLATE 3696—FULL SIZE

65099



65100



65126



65101



PLATE 3697—FULL SIZE

65123



65097



16258



PLATE 3698 - FULL SIZE

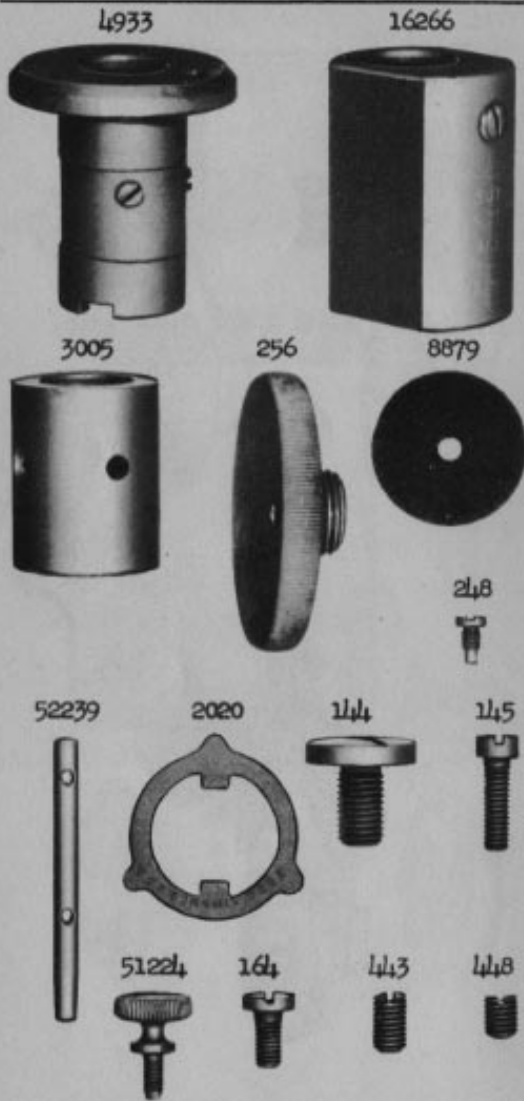

PLATE 3699 - ONE-FOURTH SIZE

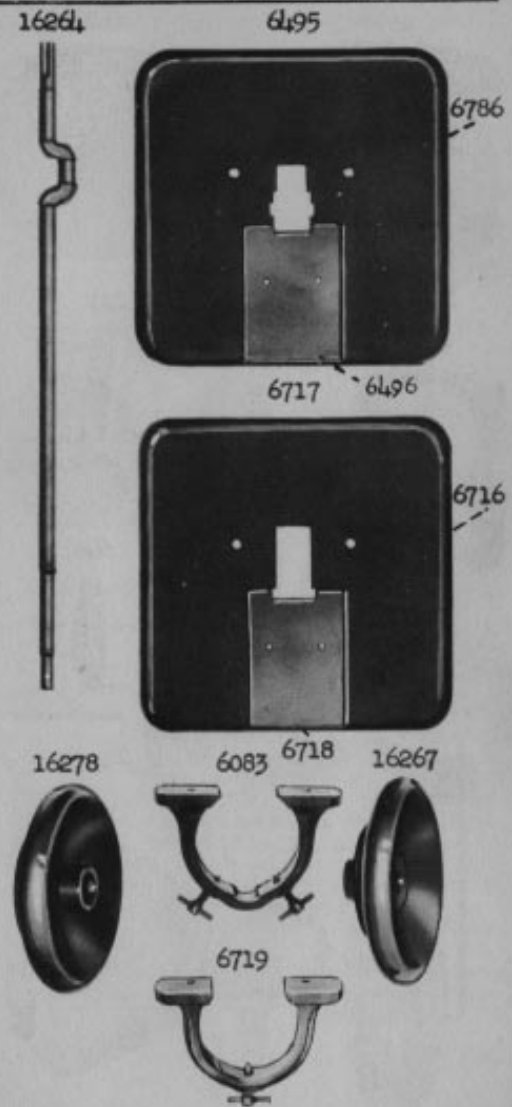
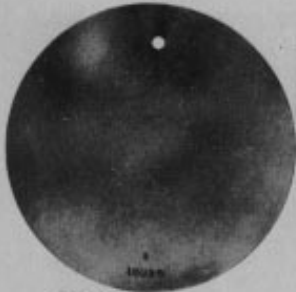
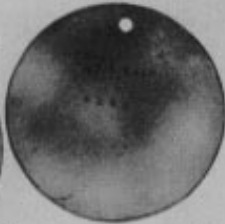

PLATE 22701 - ONE-HALF SIZE

16036



4288



15063

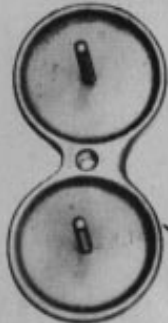

16111

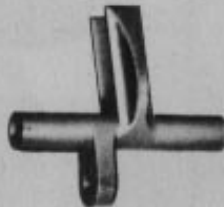

2415

6461

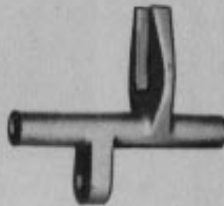

6498



16102

6497

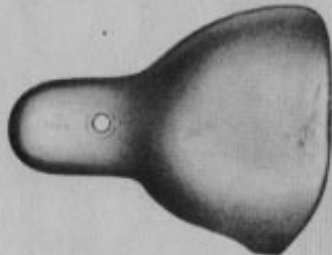

PLATE 22702 - FULL SIZE

3032



3074



3286



16045



6459

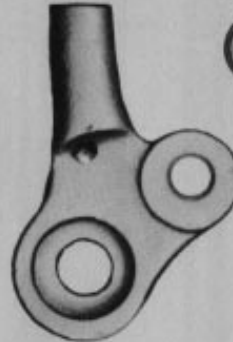

16168



818



1518



52165



345



375



2022



446



389



725



462



PLATE 22703 - ONE-HALF SIZE

6678 16275 6488 16145 16113 16055

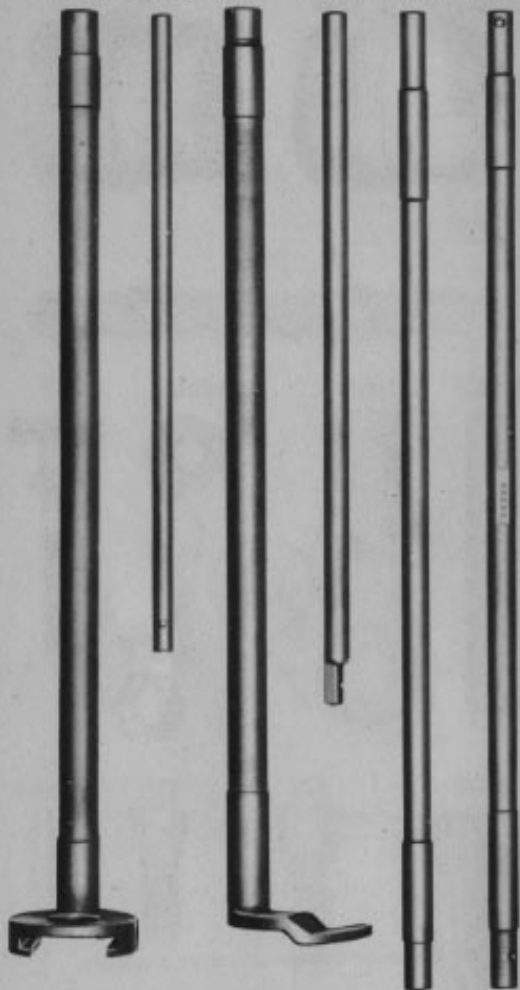

PLATE 22704 - FULL SIZE

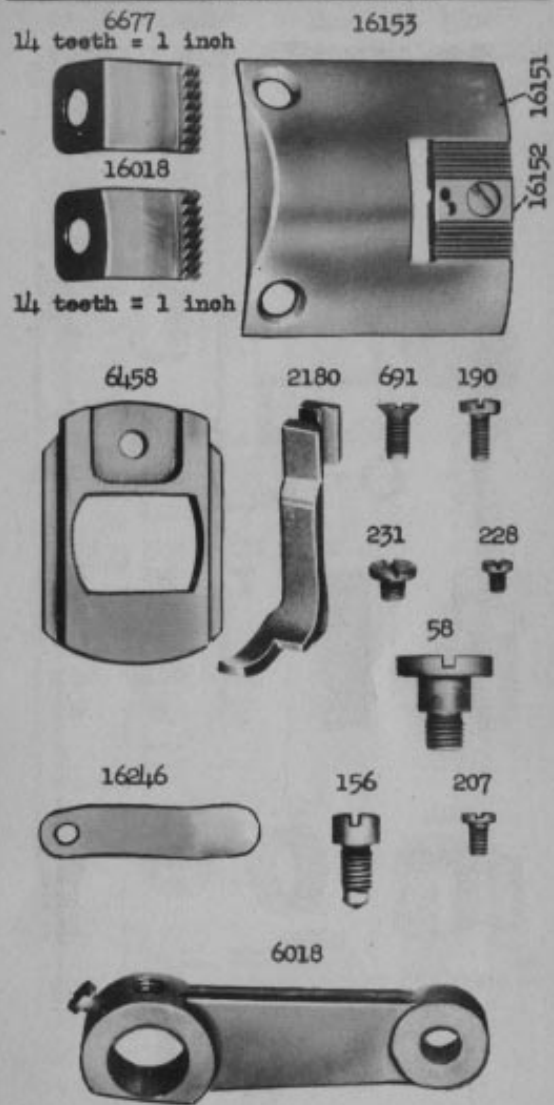

PLATE 22705 - FULL SIZE

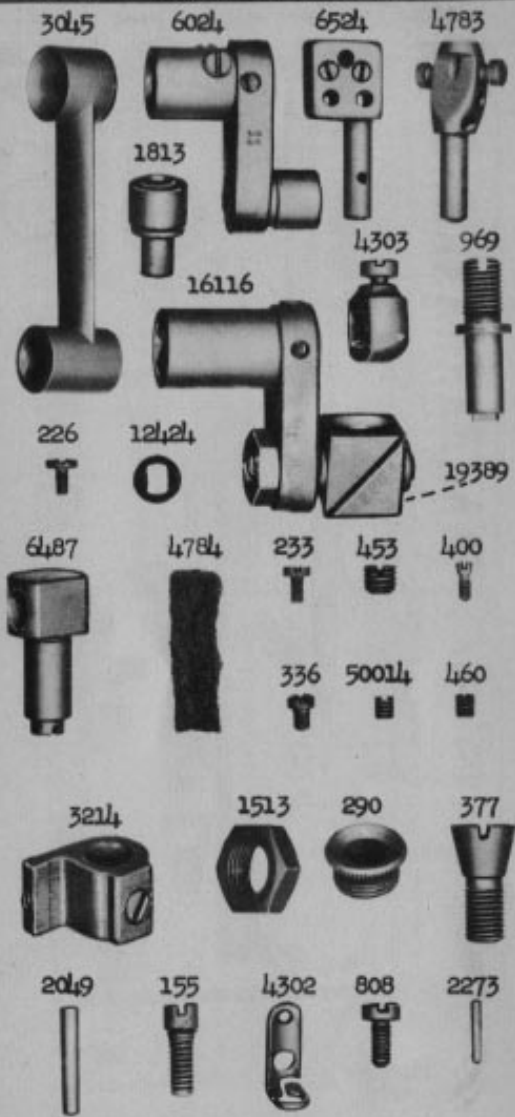

PLATE 22706 - FULL SIZE

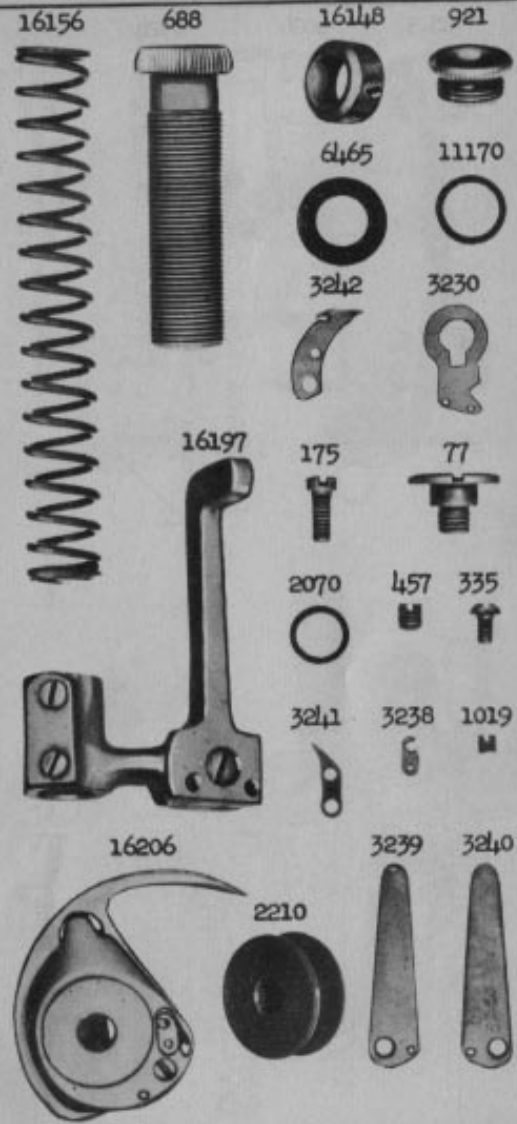
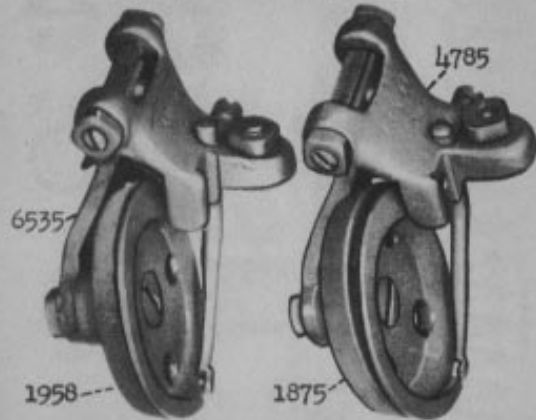

PLATE 22707 - FULL SIZE

16082

16014



16071

16017

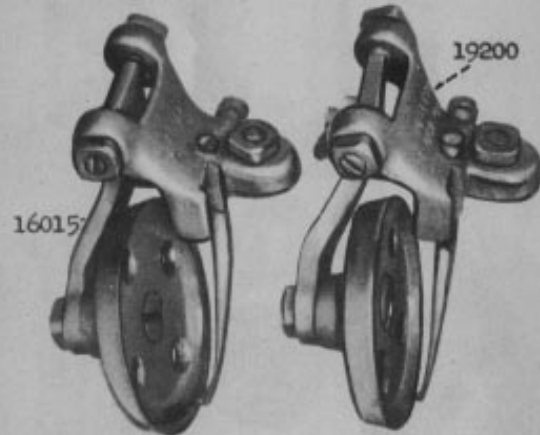
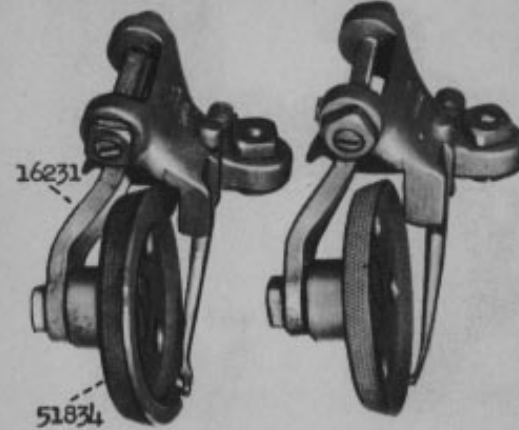

PLATE 22708 - FULL SIZE

16234

16235



16237

16260

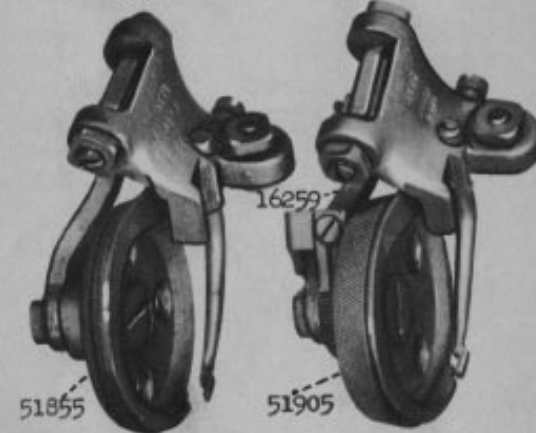

PLATE 22709 - FULL SIZE

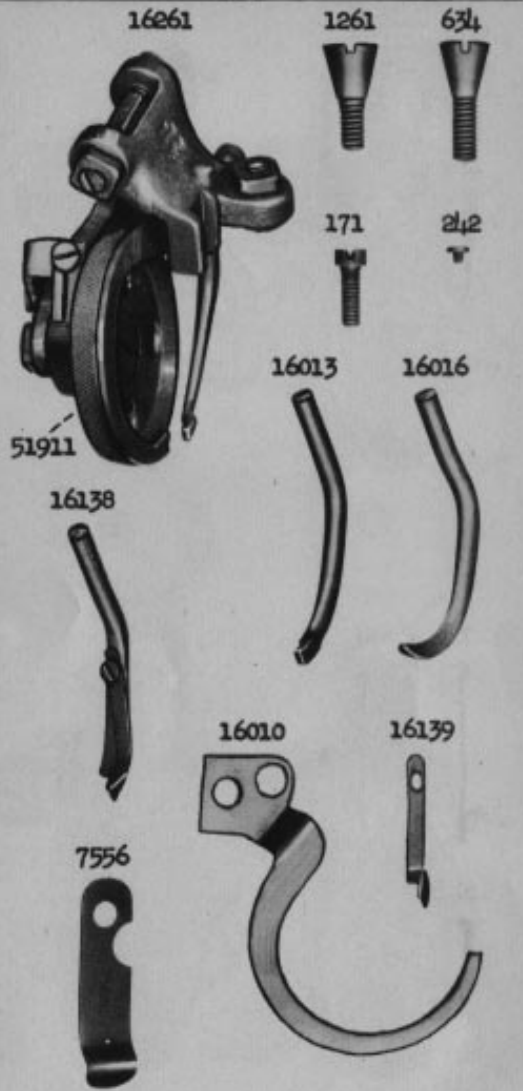

PLATE 22710 - FULL SIZE

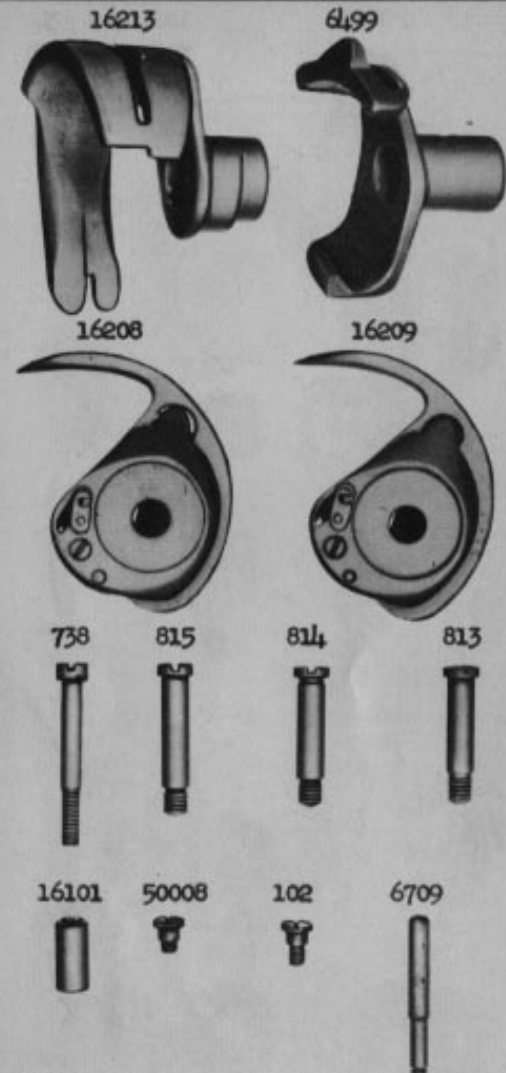

PLATE 22711 - FULL SIZE



PLATE 22712 - FULL SIZE

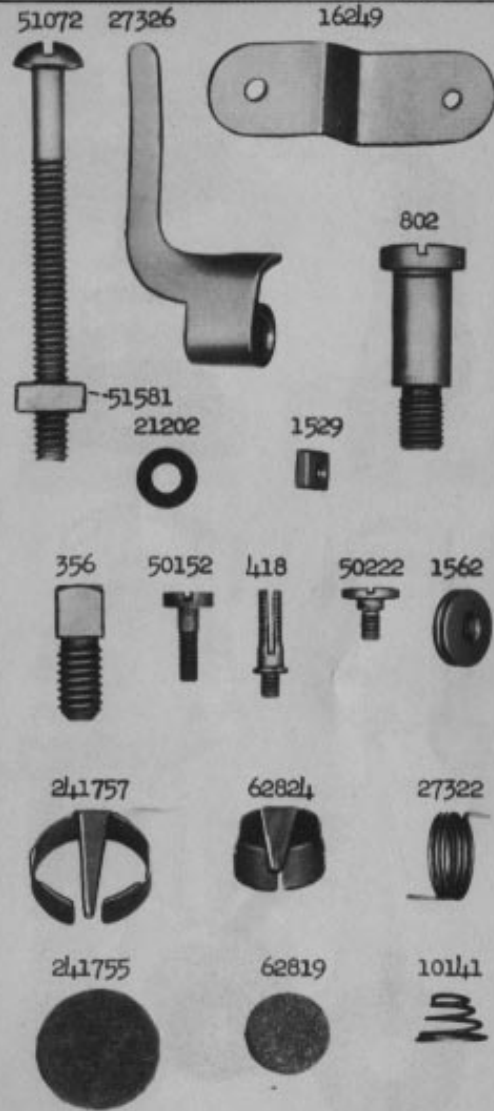



PLATE 22713 - ONE-HALF SIZE

16136



16239



16238

6758



16103



6472



6500

16244



16243

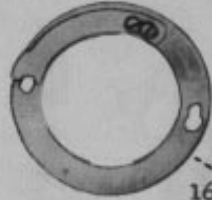

16046

16254



PLATE 22714 - ONE-HALF SIZE

120342



120343

26026



8909



8908



26485



4822

