

Singer 31-52

Singer 31-62

M 18955
(236)
PRINTED IN U. S. A.

LIST OF PARTS



MACHINES

Nos. 31-52 and 31-62

THE SINGER MANUFACTURING COMPANY

INSTRUCTIONS FOR OILING

To ensure easy running and prevent unnecessary wear of the parts which are in movable contact, the machine requires oiling and when in continuous use, it should be oiled at least twice each day with Singer Manufacturing Sewing Machine Oil (Cloth and Leather).

Copyright, U. S. A., 1933 and 1936
by The Singer Manufacturing Co.
All Rights Reserved for all Countries

INDEX

	Page
Attachments and Accessories.....	18
Belt Guard.....	19
Binders.....	24
Bobbin Winders.....	19
Driving Attachment.....	22
Folders.....	25
Foot Lifter Parts.....	41
Guides.....	27
Hemmer.....	28
Knee Lifter Parts.....	42
Lap Seam Fellers.....	29
Machine Base.....	18
Machine No. 31-52.....	5
Machine No. 31-62.....	18
Numerical List of Parts.....	45
Presser Feet.....	31
Presser Foot Extensions.....	33
Presser Foot Strip Gauge.....	33
Quilters.....	33
Rufflers.....	34
Shirt Closing Parts.....	37
Spool Fixture (Wire).....	41
Spool Holder.....	39
Tape Holders.....	39
Tape Spool Fixture (Wire).....	40
Throat Plates and Feed Dogs.....	38
Thread Unwinder.....	44
Wrenches.....	44

INSTRUCTIONS FOR ORDERING

In ordering from this list, use **ONLY** the part **NUMBER** in the **FIRST** column.

The number stamped on a Sewing Machine Part is in every case the number of the single part only.

Every combination of parts sent out as such has its specific number, which, although not stamped on the parts, must be used when ordering the combination.

Each number always indicates the **SAME PART** in whatever list it appears, or for whatever machine.

The letters after some of the numbers indicate the style of finish only, as follows:

A-Hardened, Polished, Nickel Plated and Buffed

B-Polished, Nickel Plated and Buffed

C-Hardened Only

D-Polished Only

E-Soft, Not Polished

F-Hardened and Polished

G-Bright Rumbled and Nickel Plated

H-Blued

J-Nickel Plated Only

K-Hardened and Nickel Plated

L-Brass Plated

M-Oxidized

N-Japanned, Dull

P-Japanned, Bright

R-Merlized

T-Copper Plated

T.A-Hardened, Polished, Copper and Nickel Plated and Buffed

T.B-Copper and Nickel Plated and Polished

T.J-Copper and Nickel Plated Only

T.K-Hardened, Copper and Nickel Plated

T.M-Copper Plated and Oxidized

T.L-Copper and Brass Plated

U-Zinc Plated

V-Silver Plated

W-Polished and Nickel Plated

Y-Black Nickel Plated Only

Z-Chromium Plated

Z.B-Polished, Nickel Plated, Buffed and Chromium Plated

Z.J-Nickel and Chromium Plated

These letters **MUST BE USED** when they appear in the list; and **AFTER** the number as in the list.

In this series:

1 to 1500, 50001 to 51500 and 140001 to 142000 are Screw Numbers

1501 to 1800 and 51501 to 51800 are Nut Numbers

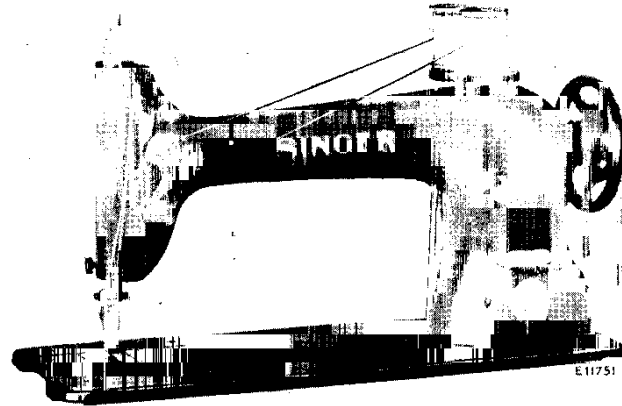
1801 to 2000 and 51801 to 52000 are Roller Numbers

2001 to 50000 and 52001 to 140000 and 142001 to 190000 are Sewing Machine Parts, 190001 and upward are numbers of Electrical Parts.

The figures in the second column refer only to the plates, illustrating the parts, and are **NOT TO BE USED** in ordering.

Parts marked with an asterisk (*) are furnished only when repairs are made at factory.

LIST OF PARTS COMPLETE FOR



MACHINE No. 31-52

FOR CLOTH. GAUGES FROM 1/32 TO 1/4 INCHES. HIGH
RAISE DROP FEED. SPEED 2000 R. P. M.

No.	Plate	Name
*20013	----	Arm with 11104, 15404 and two 15405.....
8582	8645	" Dowel Pin.....
12453	8645	" Oil Tube for intermediate bearing....
15783	----	" " " " 11119.....
11119	8645	" " " 15783 with 52045, for oiling 19156.....
12454	8645	Arm Oil Tube with 132590, for oiling 12409
24131	8645	" " " " 52045, for oiling 19276
52045	8645	" " " Packing (wick).....
132590	8645	" " " " (wick).....
748E	8645	" Screw (back).....
854E	8645	" " (front).....
12427	8677	" Shaft.....
*11104	----	" Bushing (front).....
12357	8649	" " Flanged Bushing (back).....
448C	8645	" " " " " Set Screw.

No.	Plate	Name
144D	8645	Arm Shaft Screw.....
12480	8649	" Side Cap.....
219D	5773	" " " Screw.....
12193	8648	" " " Cover.....
51224D	8645	" " " Thumb Screw.....
2415	8648	" Spool Bracket.....
15083	8648	" " " 2415 with two 12403...
145D	8645	" " " Screw.....
12403	8681	" " " Spool Pin and Thread Eyelet.....
11241	8681	Arm Spool Bracket Spool Pin Washer (cloth).....
12358	8677	Balance Wheel (power) light rim, 2 3/16 in. pulley, with two 448C.....
4370	8677	Balance Wheel (stand) heavy rim, 2 3/4 in. pulley with two 448C.....
448C	8645	Balance Wheel Set Screw.....
*20014	----	Bed.....
20197	8648	Crank Connecting Rod with two 896C.....
896C	8645	" " " Cap Screw.....
908C	8645	" " " Hinge Screw.....
1619E	8645	" " " " " Nut....
19304	----	Face Plate.....
19305	8649	Face Plate complete, Nos. 19155, 19304 and 19327.....
190D	2070	Face Plate Screw.....
19327	8672	" " " Thread Guard (lower) with 12152.....
12152	8672	Face Plate Thread Guard (lower) Rivet...
62624	8672	" " " " (upper).....
19155	----	" " " " " 62624 with 12152.....
12152	8672	Face Plate Thread Guard (upper) Rivet...
51224D	8645	" " " Thumb Screw.....
19111	8649	Feed Bar.....
313C	8672	" " " " " Screw Center.....
1519E	8672	" " " " " Nut.....
3033	8672	" " " " " Connecting Link.....
375C	5772	" " " " " Hinge Screw.....
1519E	5772	" " " " " Nut....
19338	786	" Dog, 13 teeth (16 teeth to the inch) with 19118, for 19287, for general work.....
20103	800	Feed Dog, 10 teeth (16 teeth to the inch) with 19118, for 43964.....
20373	8652	Feed Dog, 10 teeth (16 teeth to the inch) with 19118, for 20375, for edge stitching on curves, for shirt bosoms.....

No.	Plate	Name
20383	8652	Feed Dog, 13 teeth (16 teeth to the inch) with 19118, for 20384.....
20294	8659	Feed Dog, 15 teeth (16 teeth to the inch) with 19118, for 20081.....
19339	786	Feed Dog, 9 teeth (16 teeth to the inch) with 19118, for 19288, for general work.....
19482	8659	Feed Dog, 12 teeth (16 teeth to the inch) with 19118, for 19484, for rounding overgaiters.....
19479	8658	Feed Dog, 7 teeth (16 teeth to the inch) with 19118, for 19481, for staying overgaiters.....
20086	799	Feed Dog, 9 teeth (16 teeth to the inch) with 19118, for 20087, for heavy bolting cloth.....
24449	8658	Feed Dog, 15 teeth (16 teeth to the inch) with 19118, for 24450, for rounding overgaiters.....
20068	8653	Feed Dog, 18 teeth (16 teeth to the inch) with 19118, for 20069, for boning and corset strips.....
20072	8653	Feed Dog, 14 teeth (16 teeth to the inch) with 19118, for 20073.....
19343	789	Feed Dog, 14 teeth (16 teeth to the inch) with 19118, for 19290, for general work.....
19341	789	Feed Dog, 16 teeth (16 teeth to the inch) with 19118, for 19291, for knit goods and general work.....
20391	2085	Feed Dog, 16 teeth (16 teeth to the inch) with 19118, for 20392.....
20074	797	Feed Dog, 16 teeth (16 teeth to the inch) with 19118, for 20075, for knit goods and general work.....
20316	8654	Feed Dog, 14 teeth (16 teeth to the inch) with 19118, for 20079.....
20084	799	Feed Dog, 14 teeth (16 teeth to the inch) with 19118, for 20085, for general work.....
20279	2077	Feed Dog, 16 teeth (16 teeth to the inch) with 19118, for 20280, for knit goods and general work.....
1910	8653	Feed Dog Screw.....
19116	8672	" " " Spring.....
19117	8672	" " " " " Hook for 19120.....
19118	8672	" " " " " " " Feed Dogs.....

No.	Plate	Name
19275	8649	Feed and Feed Lifting Eccentric with 446C.....
446C	8672	Feed and Feed Lifting Eccentric Set Screw.....
12429	8648	Feed Forked Connection.....
375C	5772	" " " Hinge Screw.....
1518E	5772	" " " Nut.....
12374	8677	" Lifting Rock Shaft.....
20015	----	Feed Lifting Rock Shaft complete, Nos. 3043J, 12374 and 19120.....
3043J	8664	Feed Lifting Rock Shaft Crank (back) with 462C.....
2049	5772	Feed Lifting Rock Shaft Crank (back) Pin
462C	8672	" " " " " " Set Screw.....
19120	8649	Feed Lifting Rock Shaft Crank (front) with 157E, 19117, 19121 and 19122.....
157E	8672	Feed Lifting Rock Shaft Crank (front) Clamping Screw.....
19121	8672	Feed Lifting Rock Shaft Crank (front) Roller.....
19122	8672	Feed Lifting Rock Shaft Crank (front) Roller Pin.....
43976	8648	Feed Lifting Rock Shaft Crank Connecting Rod (cast iron) with two 966E.....
966E	8672	Feed Lifting Rock Shaft Crank Connecting Rod Cap Screw.....
375C	5772	Feed Lifting Rock Shaft Crank Connecting Rod Hinge Screw.....
1518E	5772	Feed Lifting Rock Shaft Crank Connecting Rod Hinge Screw Nut.....
307C	8672	Feed Lifting Rock Shaft Screw Center....
1513E	8672	" " " " " " Nut.....
3039	8649	" Regulator.....
1128E	8672	" " Hinge Screw.....
818D	8672	" " Thumb Screw.....
12379	8677	" Rock Shaft.....
20333	----	Feed Rock Shaft complete, Nos. 12379 and 29633.....
29633	8664	Feed Rock Shaft Crank with 157J.....
157J	8672	" " " " Clamping Screw....
307C	8672	" " " " Screw Center.....
1513E	8672	" " " " Nut.....
18014	8664	Needle Bar (hollow).....
*12382	1144	" " Connecting Link with 794E....
794E	1144	" " " " Adjusting Screw.....
*12383	----	Needle Bar Connecting Stud.....

No.	Plate	Name
12384	1144	Needle Bar Connecting Stud complete, Nos. 453C, 1904 and 12383.....
1904	1144	Needle Bar Connecting Stud Roller (roller only).....
453C	8646	Needle Bar Connecting Stud Set Screw....
20188	8649	" " Crank with 858C and 1065C....
1065C	8646	" " " Position Screw.....
858C	8646	" " " Set Screw.....
936E	8646	" " Screw Bushing.....
19276	8646	" Clamp with two 209F.....
2273	8646	" " Pin.....
209F	8212	" Set Screw.....
*19386	8649	Oscillating Rock Shaft.....
19387	----	Oscillating Rock Shaft complete, Nos. 4784, 12388 and 19386.....
12388	8649	Oscillating Rock Shaft Hinge Pin.....
878D	8646	" " " " " Oil Hole Stop Screw.....
12459	8646	Oscillating Rock Shaft Hinge Pin Oil Hole Stop Screw Washer (leather)....
448C	8645	Oscillating Rock Shaft Hinge Pin Set Screw.....
4784	8646	Oscillating Rock Shaft Oil Pad.....
20016	8677	" Shaft.....
19496	----	" " Crank.....
19388	8646	Oscillating Shaft Crank complete, Nos. 457C, 1518E, 19390 and 19496.....
2049	5772	Oscillating Shaft Crank Pin.....
457C	8646	" " " Set Screw.....
19389	8646	" " " Slide Block....
226D	2070	" " " " " Cap Screw.....
12424	8646	Oscillating Shaft Crank Slide Block Cap Screw Washer.....
969C	8646	Oscillating Shaft Crank Slide Block Screw Stud.....
1518E	5772	Oscillating Shaft Crank Slide Block Screw Stud Nut.....
19390	----	Oscillating Shaft Crank Slide Block complete, Nos. 226D, 969C, 12424 and 19389.....
12391	8664	Presser Bar (hollow).....
12326	8646	" " Guide Bracket with 453C....
453C	8646	" " " Set Screw....
52016	8664	" " Lifter.....
689C	8646	" " " Screw.....
1520E	8646	" " " Nut.....
12327	8671	" " Lifting and Releasing Lever Bracket.....

No.	Plate	Name
11187	8664	Presser Bar Spring (light) .051 wire....
Note: No. 11187 is sent with this machine unless another spring is specified on order.		
12139	8664	Presser Bar Spring (medium) .055 wire....
20023	8664	" " " (heavy) .063 wire....
11170	8648	" " " Washer.....
19128	8665	" Foot, for general work.....
19218	8668	" " with 228D, for strip gauge
19480	8665	" " for staying overgaiters, for 19479.....
19483	8665	Presser Foot, for rounding overgaiters, for 19482.....
120157	8665	Presser Foot (double tube) for two strips.....
20046	8665	Presser Foot (tube).....
20050	1224	" " " for taping.....
20052	1224	" " " for outside stays and strips.....
20053	1224	Presser Foot (strip) for boning.....
20171	8665	" " (tube) for cording and cover- ing one cord with strip.....
20374	8665	Presser Foot with guide on bottom to the right of needle holes, for 20373....
20302	8665	Presser Foot with guide on bottom to the right of needle holes.....
26276	8667	Presser Foot Hinge Pin.....
20044	----	" " Plate.....
26275	----	" " Shank.....
20045	8667	Presser Foot (hinged) complete, Nos. 20044, 26275 and 26276.....
26276	8667	Presser Foot Hinge Pin.....
20047	----	" " Plate.....
20048	----	" " Shank.....
26231	8667	" " Spring.....
20049	1224	Presser Foot (spring hinged) tube, com- plete, Nos. 20047, 20048, 26231 and 26276.....
18055	8667	Presser Foot Hinge Pin.....
20129	----	" " Plate.....
20130	----	" " Shank.....
20131	8667	Presser Foot (hinged) complete, hollowed across bottom between needle holes and heel, for riding seams, for gen- eral work, Nos. 18055, 20129 and 20130.....
26276	8667	Presser Foot Hinge Pin.....
20188	----	" " Plate.....
20189	----	" " Shank.....

No.	Plate	Name
20170	8667	Presser Foot (hinged) complete, 5/32 in. and above, for rounding overgaiters, Nos. 20188, 20189 and 26276.....
26276	8667	Presser Foot Hinge Pin.....
44186	----	" " Plate.....
20189	----	" " Shank.....
44187	8667	Presser Foot (hinged) complete for 1/8 in. gauge and below, for rounding overgaiters, Nos. 20189, 26276 and 44186.....
26276	8667	Presser Foot Hinge Pin.....
43894	----	" " Plate.....
20048	----	" " Shank.....
26231	8667	" " Spring.....
43895	8667	Presser Foot (spring hinged) tube, com- plete for taping, Nos. 20048, 26231, 26276 and 43894.....
26276	8667	Presser Foot Hinge Pin.....
43973	----	" " Plate.....
43974	----	" " Shank.....
26231	8667	" " Spring.....
43975	8667	Presser Foot (spring hinged) complete, for bolting cloth, Nos. 26231, 26276, 43973 and 43974.....
190D	2070	Presser Foot Screw.....
688E	8682	Pressure Regulating Thumb Screw.....
19131	8651	Shuttle (inside) Bobbin.....
62606	----	" " " Case.....
1931C	8651	" " " " Latch and Position Finger.....
2521	1255	Shuttle (inside) Bobbin Case Latch and Position Finger Spring.....
592E	8651	Shuttle (inside) Bobbin Case Latch and Position Finger Stop Screw.....
19312	8651	Shuttle (inside) Bobbin Case complete, Nos. 591F, 592E, 2521, 19149, 1931C and 62606.....
19136	8651	Shuttle (inside) Body.....
591F	8651	" " Tension Regulating Screw.....
19149	8651	Shuttle (inside) Tension Spring.....
19324	8651	" " " 1 11/16 in. diam., Nos. 19131, 19136 and 19312.....
19131	8651	Shuttle (outside) Bobbin.....
62608	----	" " " Case.....
19311	8651	" " " " Latch and Position Finger.....
2521	1255	Shuttle (outside) Bobbin Case Latch and Position Finger Spring.....

No.	Plate	Name
592E	8651	Shuttle (outside) Bobbin Case Latch and Position Finger Stop Screw.....
19313	8651	Shuttle (outside) Bobbin Case complete, Nos. 591F, 592E, 2521, 19172, 19311 and 62608.....
19171	8650	Shuttle (outside) Body for 19328.....
19137	8650	" " " " 19325.....
591F	8651	" " " Tension Regulating Screw.....
19172	8650	Shuttle (outside) Tension Spring.....
19326	8650	Shuttle (outside) 1 11/16 in. diam., for 1/32 in. to 13/64 in. gauge, Nos. 19131, 19171 and 19313.....
19325	8650	Shuttle (outside) 1 11/16 in. diam., for 7/32 in. gauge and above, Nos. 19131, 19137 and 19313.....
19139	8664	Shuttle Driver with two 453C.....
2049	5772	" " " Pin.....
453C	8646	" " " Set Screw.....
24490	----	" " Race Body with 19316, for 24493.
19315	----	" " " " 19316, for 19323.
19379	----	" " " " for 24013.....
19316	1213	" " " Loop Separator for 19315 and 24490.....
24492	1241	Shuttle Race Needle Guard for 24493.....
19309	1213	" " " " " 19323 and 24013.....
1053D	1241	Shuttle Race Needle Guard Screw.....
19317	1213	" " " Ring (inside) for 19323, 24013 and 24493.....
19381	8664	Shuttle Race Ring (outside) for 24493...
19318	1213	" " " " " 19323 and 24013.....
2532	1245	Shuttle Race Ring Position Pin.....
2533	8664	" " " " Spring.....
907D	8650	" " " " Screw.....
24493	1241	Shuttle Race complete, for 1/32 in. to 5/64 in. gauge, Nos. 19317, 19381, 24490, 24492, two each 907D, 1053D, 2533 and four 2532.....
19323	1213	Shuttle Race complete, for 3/32 in. to 5/32 in. gauge, Nos. 19309, 19315, 19317, 19318, two each 907D, 1053D, 2533 and four 2532.....
24013	8664	Shuttle Race complete, for 11/64 in. gauge and above, Nos. 19309, 19317, 19318, 19379, two each 907D, 1053D, 2533 and four 2532.....
145F	8645	Shuttle Race Screw.....

No.	Plate	Name
19145	8673	Shuttle Race Slide (inside).....
19146	8673	" " " (outside) for 7/16 in. gauge and below.....
19281	8673	Shuttle Race Slide (outside) for 15/32 in. to 15/16 in. gauge.....
19385	8673	Shuttle Race Slide (outside) for 31/32 in. to 1 1/4 in. gauge.....
19147	8650	Shuttle Race Slide Friction Spring.....
651E	8650	" " " " " Screw
19148	8673	" " " Guide (back) with 651E and 19147.....
19185	8673	Shuttle Race Slide Guide (front) with 651E and 19147.....
691F	8650	Shuttle Race Slide Guide Screw.....
2921	1146	Tension Disc.....
19191	1146	" Plate, for upper tension, with 19231.....
134D	8650	Tension Plate Screw.....
1560C	1146	" Regulating Thumb Nut.....
19192	1146	" Releaser.....
43944	8649	" Releasing Lever.....
12398	8650	" " " Hinge Pin.....
12329	8650	" " " Spring.....
19193	1146	" " " (intermediate)..
19231	1146	" " " " Hinge Block.....
2269	1146	Tension Releasing Lever (intermediate) Hinge Pin.....
19194	1146	Tension Releasing Lever (intermediate) Spring.....
916C	1146	Tension Screw Stud.....
44209	----	" " " 916C with 1560C.....
1547D	1146	" " " Nut.....
2923	1146	" Spring.....
19195	1146	Tension (upper) complete with Tension Release, Nos. 2269, 19191, 19193, 19194 two each 1547D, 2923, 19192, 44209 and four 2921.....
12149	8671	Thread Guard for 19162.....
19159	8671	" Guide Body.....
19161	8671	" " Cap.....
19180	8671	" " Roller.....
905D	8671	" " Screw.....
19182	----	Thread Guide complete (roller) Nos. 905D and 19159 to 19161.....
24129	1144	Thread Take-up Crank.....
3094	1144	" " " Wedge.....
690E	1144	" " " Screw.....
19156	1144	" " " Lever.....

No.	Plate	Name
775E	1144	Thread Take-up Lever Cap Screw.....
12188	1144	" " " Hinge Pin.....
12409	1144	" " " Link.....
11204	1144	" " " Hinge Pin....
435C	8671	" " " " " Set Screw.....
19157	1144	Thread Take-up Lever complete, Nos.12188 12409 and 19156.....
19158	8671	Thread Take-up Spring (music wire).....
7326	8671	" " " Regulator.....
448C	8645	" " " " " Set Screw
19287	786	Throat Plate for 1/32 in. to 3/16 in. gauge for 19336.....
43964	2082	Throat Plate (flush) for 3/32 in. to 1/8 in. gauge, for 20103.....
20375	8652	Throat Plate for 3/32 in. to 3/16 in. gauge for 20373.....
20384	8652	Throat Plate for 3/32 in. to 3/16 in. gauge for 20383.....
20081	8659	Throat Plate for 3/32 in. to 1/4 in. gauge for 20294.....
19288	786	Throat Plate for 3/32 in. to 5/16 in. gauge for 19339.....
19484	8659	Throat Plate with 240D,19485, 19486 and 25786, for 1/8 in. to 1/4 in. gauge, for 19482.....
19481	8656	Throat Plate with 4515, for 1/8 in. to 5/16 in. gauge, for 19479.....
20087	799	Throat Plate for 3/16 in. to 5/16 in. gauge, for 20088.....
24450	8658	Throat Plate with 240D,19485,19486 and 25786, for 3/16 in. to 5/16 in.gauge for 24449.....
20069	8653	Throat Plate for 3/16 in. to 1/2 in. gauge, for 20068.....
20073	8653	Throat Plate for 3/16 in. to 1/2 in. gauge, for 20072.....
19290	789	Throat Plate for 7/32 in. to 1/2 in. gauge, for 19343.....
19291	789	Throat Plate for 7/32 in. to 5/8 in. gauge, for 19341.....
20392	2085	Throat Plate with 240D,19485,19486 and 25786, for 17/32 in. gauge, for 20391, for under strip.....
20075	797	Throat Plate for 17/32 in. to 13/16 in. gauge, for 20074.....
20079	8654	Throat Plate for 17/32 in. to 13/16 in. gauge, for 20316.....

No.	Plate	Name
20085	799	Throat Plate for 27/32 in. to 1 1/4 in. gauge, for 20084.....
20280	2077	Throat Plate for 27/32 in. to 1 1/4 in. gauge, for 20279.....
19485	2085	Throat Plate Arm for 19484,20392 and 24450.....
25786	2085	Throat Plate Arm Rivet.....
691F	8650	" " " Screw.....
4515	8682	" " " Spring Guide for 19481.....
19486	2085	" " " " " 19484,20392 and 24450.....
240D	8662	Throat Plate Spring Guide Screw for 19484,20392 and 24450.....
*15404	----	Trade Mark.....
15405	----	" " Rivet.....
44212	8678	Drip Pan with four 1 in. wire nails.....

Genuine Singer Needles should be used
in Singer Machines.
These Needles and their Containers
are marked with the
Company's Trade Mark "SIMANCO." 1

Needles in Containers marked
"For Singer Machines"
are not Singer made needles. 2

MACHINE No. 31-62

FOR STITCHING IN LIGHT AND MEDIUM WEIGHT FABRICS.
GAUGES FROM 3/32 TO 1 1/4 INCHES. DROP FEED. ALTERNATING PRESSERS. SPEED 2000 R.P.M.

NOTE: THIS MACHINE IS THE SAME AS THE 31-52 MACHINE WITH THE FOLLOWING EXCEPTIONS.

No.	Plate	Name
*43948	----	Arm with 11104, 15404 and two 15405, in place of 20013.....
20475	----	Face Plate.....
20395	8670	Face Plate complete, Nos. 19155, 19327 and 20475, in place of 19305.....
219F	5773	Face Plate Screw, in place of 190D.....
12391	8664	Lifting Presser Bar (hollow).....
19356	5772	" " " Bell Crank.....
199D	5772	" " " " " Cap Screw
19357	5772	" " " " " Connect- ing Link.....
199D	5772	Lifting Presser Bar Bell Crank Connect- ing Link Cap Screw.....
19358	5772	Lifting Presser Bar Bell Crank Driving Arm.....
2049	5772	Lifting Presser Bar Bell Crank Driving Arm Pin.....
19359	5772	Lifting Presser Bar Bell Crank Driving Arm Shaft.....
19360	8669	Lifting Presser Bar Bell Crank Driving Arm Shaft Bracket.....
19361	----	Lifting Presser Bar Bell Crank Driving Arm Shaft Bracket complete, Nos. 2049 and 19358 to 19360.....
965D	5773	Lifting Presser Bar Bell Crank Driving Arm Shaft Bracket Screw.....
19362	5772	Lifting Presser Bar Bell Crank Driving Arm Eccentric Connection.....
375C	5772	Lifting Presser Bar Bell Crank Driving Arm Eccentric Connection Hinge Screw
24589	8669	Lifting Presser Bar Guide Bracket with 453C.....
453C	8646	Lifting Presser Bar Guide Bracket Set Screw.....

PARTS FOR MACHINE NO. 31-62

No.	Plate	Name
43956	----	Lifting Presser Bar Guide Bracket com- plete, Nos. 19356, 19357, 24589, 43949 and three 199D.....
24590	8669	Lifting Presser Bar Guide Bracket Sup- port.....
175D	8650	Lifting Presser Bar Guide Bracket Sup- port Screw.....
4855	5772	Lifting Presser Bar Lifter.....
889C	8646	" " " " " Screw.....
1520E	8646	" " " " " Nut....
12327	8671	" " " " " Lifting and Releas- ing Lever Bracket.....
11167	9664	Lifting Presser Bar Spring (light) .051 wire.....
Note: No. 11167 is sent with this machine unless another spring is specified on order.		
12139	8664	Lifting Presser Bar Spring (medium) .055 wire.....
20023	8664	Lifting Presser Bar Spring (heavy) .083 wire.....
11170	8646	Lifting Presser Bar Spring Washer.....
20482	5773	" " " " " Foot.....
193D	5773	" " " " " Screw.....
19365	8669	Needle Bar Crank and Lifting Eccentric with 448C and 743C, in place of 20188
743C	5773	Needle Bar Crank and Lifting Eccentric Position Screw.....
448C	8645	Needle Bar Crank and Lifting Eccentric Set Screw.....
43949	5773	Vibrating Presser Bar.....
19367	5573	" " " " " Cap.....
199F	5772	" " " " " Screw for 43949
219F	5773	" " " " " " " 19367
19368	5773	" " " " " Cushion (rawhide).
19369	5773	" " " " " Spring.....
335D	5773	" " " " " Screw.....
20483	5773	" " " " " Foot.....
217D	5773	" " " " " Screw.....

MACHINE BASE

No.	Plate	Name
19219	8675	Bed Frame Cushion (leather).....
158C	8675	" " " Screw.....
19220	8675	" " " Spring.....
19226	8675	" " Hinge Connection.....
19398	----	" " " " 19226 with 211E and 19397.....
19397	8675	Bed Frame Hinge Connection Cap.....
211E	8675	" " " " " Screw....
16555	8675	" " " " Plate.....
14010	8675	" " " " Rivet.....
20067	819	" " with two each 16555,19398, four each 19219,19220, six each 14010, wood screws 1 1/4 in. No. 12 and eight 158C.....

ATTACHMENTS AND ACCESSORIES

No.	Plate	Name
51075E	8675	Machine Hinge Bolt with 51581E.....
51581E	----	" " " " Nut.....
6055	8675	" " " " Washer.....
44180	----	Machine Hinge complete, Nos. 6055,12361, 44139 and 51075E.....
12361	8675	Machine Hinge Connection.....
44139	8675	" " " Plate.....
44140	----	Machine Hinge complete, Nos. 12361,44139 and merlized wood screw 1 1/4 in.No. 14.....
12405	8675	Machine Rest (felt).....
41400	8680	" " " Pin (wood).....
120348	8680	Oiler (copper plated) with 120347.....
120347	8680	" Spout, 8 1/2 in. long.....
26028	8680	Screw Driver (large).....
26485	8680	" " (small).....
120341	8680	Tweezers (curved).....

BELT GUARD

No.	Plate	Name
41929	8677	Belt Guard.....
8418	8686	" " Button.....
8419	8647	" " " Washer (leather).....
8420	----	" " " " 8418 with 8419 and wood screws 1 1/4 in. No. 9 R.H.B...
41930	8686	Belt Guard Hinge.....
41931	----	Belt Guard complete, Nos. 8420,41929,two 41930 and four wood screws 3/4 in. No.9.....

BOBBIN WINDERS

BOBBIN WINDER

FOR NO. 4370

No.	Plate	Name
15072	8647	Bobbin Position Pin.....
12168	8685	Bracket.....
692D	8647	" Screw for 12172.....
12169	8685	Frame.....
12171	8685	Frame complete, Nos. 333D,5960,5961,5963 12169 and 15077.....
32D	8647	Frame Hinge Screw.....
5960	8685	Friction Wheel (leather).....
5961	8685	" " Washer.....
333D	8647	" " " Screw.....
15077	8685	Spindle with 15072.....
5963	8685	" Flange.....
12170	8685	Spring.....
180F	8647	" Screw.....
12172	----	Bobbin Winder complete, Nos. 32D,180F, 12168, 12170 and 12171.....

BOBBIN WINDER
FOR NO. 12358

NOTE: THIS BOBBIN WINDER IS THE SAME AS NO. 12172
WITH THE FOLLOWING EXCEPTIONS.

No.	Plate	Name
20307	8685	Frame, in place of 12169.....
20308	8685	Frame complete, Nos. 333D,5960,5961,5963 15077 and 20307, in place of 12171..
20309	----	Bobbin Winder complete, Nos. 32D,180F, 12168,12170 and 20308.....

BOBBIN WINDER
(SWINGING AUTOMATIC, RIGHT HAND)
FOR NO. 19131
FOR POWER TABLE

No.	Plate	Name
225433	8678	Bobbin Winder and Tension Bracket Base..
225453	8686	Frame with 202277 and 225438.....
225454	8686	" Hinge Pin.....
202277	8676	" Oil Packing (wick).....
225438	8676	" Well Cap.....
225455	8686	" Spring.....
225456	8676	" Plunger.....
202473	8686	Pulley with 200380C.....
200380C	8676	" Set Screw.....
225381	8686	Spindle.....
225444	8686	Stop Latch.....
200056E	8676	" Screw.....
225458	8686	" Thumb Lever.....
225459	8676	" " Hinge Stud.....
225459	8676	" " Joint Stud.....
202478	8686	" Trip Lever.....
200299H	8676	" Hinge Screw.....
225461	8686	Tension Bracket with 201499B.....
200082D	8676	" Screw.....
228026	8676	" Washer.....

BOBBIN WINDER

21

No.	Plate	Name
2102	8676	Tension Disc.....
202407	8676	" Spring.....
201499B	8686	" Stud.....
201572B	8676	" Thumb Nut.....
225462	----	Tension Bracket complete, Nos. 201572B, 202407,225461 and two 2102.....
225382	8678	Bobbin Winder complete, Nos. 200056E, 200082D,200299H,202473,202478,225381 225433,225444,225453 to 225456, 225458,225462,228026,two each 225459 and wood screws 3/4 in. No. 12 R.H.B

BOBBIN WINDER
(SWINGING AUTOMATIC, RIGHT HAND)
FOR NO. 19131
FOR STAND

No.	Plate	Name
27540	8669	Base.....
15072	8647	Bobbin Position Pin.....
27302	8669	Frame.....
50356D	8676	" Hinge Screw.....
1820J	8676	" " Nut.....
27303	8676	" Spring.....
27541	8669	Pulley.....
*27849	----	Spindle.....
27538	8669	" 27849 with 15072,27850 and 41828
*27850	----	" Collar.....
41828	8647	" Pin.....
27306	8686	Spool Pin.....
27307	8686	" Stand.....
27308	8686	Spool Stand complete, Nos. 418E,1562J, 2106,10141,11241,27306,27307 and two each 2455 and wood screws 1 in. No. 10.....
11241	8681	Spool Washer (cloth).....
27587	8686	Stop Latch.....
35D	8647	" Hinge Screw.....
2455	8647	Tension Disc.....
1562J	8647	" Regulating Thumb Nut.....
418E	8647	" Screw Stud.....
10141	8647	" Spring.....
2106	8647	" Thread Guide.....

No.	Plate	Name
27875	----	Bobbin Winder, Nos. 35D, 1620J, 27302, 27303, 27538, 27540, 27541, 27587, 50356D and two wood screws 1 in. No. 7.....
27876	----	Bobbin Winder (swinging automatic, right hand) complete, Nos. 27308 and 27875

DRIVING ATTACHMENT

No.	Plate	Name
16592	8687	Balance Wheel (friction) with 7958, 16524 and two 435C.....
16524	----	Balance Wheel Friction Ring (leather)....
7958	8674	" " " " Stop Pin....
24355	8683	" " Oil Cover.....
210D	8674	" " " " Screw.....
435C	8671	" " Set Screw.....
15072	8647	Bobbin Position Pin for 15077.....
16514	8685	" Winder Frame.....
32D	8647	" " " Hinge Screw.....
16515	8685	Bobbin Winder Frame complete, Nos. 333D, 5960, 5961, 5963, 15077 and 16514.....
5960	8685	Bobbin Winder Friction Wheel (leather)...
5961	8685	" " " " Washer.....
333D	8647	" " " " Screw
15077	8685	" " Spindle with 15072.....
5963	8685	" " " Flange.....
27306	8686	" " Spool Pin.....
27307	8686	" " Stand.....
27308	8686	Bobbin Winder Spool Stand complete, Nos. 418E, 1562J, 2106, 10141, 11241, 27306, 27307 and two each 2455 and wood screws 1 in. No. 10.....
11241	8681	Bobbin Winder Spool Washer (cloth).....
12170	8685	" " Spring.....
180F	8647	" " " Screw.....
19258	8683	" " Stop Latch with 152F and 1550H.....
152F	8674	Bobbin Winder Stop Latch Adjusting Screw
1550H	2070	" " " " " " Nut.....
75D	8674	Bobbin Winder Stop Latch Hinge Screw....
27303	8676	" " " " Spring.....
2269	1146	" " " " Stop Pin.....
2455	8647	" " Tension Disc.....
1562J	8647	" " Regulating Thumb Nut.....

No.	Plate	Name
418E	8647	Bobbin Winder Tension Screw Stud.....
10141	8647	" " " Spring.....
2106	8647	" " " Thread Guide.....
16530	8685	Bracket.....
692D	8647	" Screw.....
12458	8687	Drip Pan with four 1 in. wire nails for 20141.....
16518	8687	Driving Arm with 2269, 2928 and two 15132
2928	8674	" " Brake (leather).....
15132	8674	" " " Rivet.....
12178	8674	" " Friction Plug (wood).....
427E	8674	" " " Adjusting Screw.....
1508C	8674	Driving Arm Friction Plug Adjusting Screw Nut.....
692D	8683	Driving Arm Hinge Screw.....
1579C	8683	" " " Nut.....
12475	8687	" " Pitman.....
20371	8683	" " " Crank.....
2022	8674	" " " Pin.....
20372	8683	" " " Spring.....
65D	8674	" " " Hinge Screw.....
19280	----	Driving Arm complete, Nos. 32D, 75D, 180F, 427E, 692D, 1508C, 1579C, 12170, 12178, 16515, 16518, 16530, 19258 and 27303...
16594	8683	Driving Friction Pulley, 2 5/16 in. diam. with 861D and 10236.....
10236	8674	Driving Friction Pulley Center Bearing..
861D	8647	" " Oil Hole Plug Screw.....
27072	----	Shaft Driving Pulley (sectional, grooved) 12 in. diam., 1 3/16 in. bore, with two 597C, for 20141.....
597C	8674	Shaft Driving Pulley Clamping Screw....
12479	8683	Starting Crank.....
2022	8674	" " Pin.....
12477	8683	" " Shaft.....
*44176	----	" " " 12477 with 12479, 20371 and two 2022.....
126036	8678	Treadle.....
126205	8683	" Bracket (left).....
126206	----	Treadle Bracket (left) complete, Nos. 23258, 126205, 126207, 126208 and two wood screws 1 in. No. 14.....
126207	8683	Treadle Bracket (left) Hook.....
23258	8674	" " " Friction Washer.....
126208	8674	Treadle Bracket (left) Hook Rivet.....
46681	8683	" " (right).....

DRIVING ATTACHMENT

No.	Plate	Name
80502	----	Treadle Bracket (right) 46681 with two wood screws 1 in. No. 14.....
126209	----	Treadle complete, Nos. 80502, 126036 and 126208.....
27637	8697	Treadle Pitman Rod (lower).....
150208	8685	" " " " Spring.....
8055	8675	" " " " Washer.....
14081	8687	" " " " (upper).....
80223	8687	" " " " Clamp with 361C.....
361C	8674	" " " " Screw.....
2762	8687	" " " " Stop Collar with 362C.....
362C	8674	" " " " Set Screw.....
14233	8687	Treadle Pitman complete, Nos. 2762, 8055, 14081, 27637, 80223 and 150208.....
126213	----	Treadle and Pitman complete, Nos. 14233 and 126209.....
20141	----	Driving Attachment with Bobbin Winder and Treadle complete, Nos. 210D, 692D 12475, 18592, 18594, 19260, 20372, 24355, 27072, 27308, 44176, 126213 and two 65D

BINDERS

FOR MACHINE NO. 31-62

No.	Plate	Name
35691	1248	Binder on Slide 18114, for 1/2 in. to 1 1/2 in. ribbon binding, for blankets.....
35692	8677	Binder on Slide 18114, for 1 9/16 in. to 2 1/2 in. ribbon binding, for blankets.....
35693	8677	Binder on Slide 18114, for 2 9/16 in. to 3 1/2 in. ribbon binding, for blankets.....
18114	8673	Binder Slide.....
35694	1249	Feed Dog with 21 teeth (16 teeth to the inch) with 19118, for 35691 to 35693 and 35695.....
19118	8672	Feed Dog Spring Hook.....
35696	1249	Lifting Presser Foot for 35691.....
35698	1249	" " " " 35692 and 35693
35695	1249	Throat Plate for 3/16 in. to 5/16 in. gauge, for 35691 to 35694.....
35697	1249	Vibrating Presser Foot for 35691.....
35699	1249	" " " " 35692 and 35693

FOLDERS

EDGE FOLDERS

No.	Plate	Name
26965	2660	Edge Folder (left hand) on Slide complete, with right hand upper guide, for folding bobbinette curtains and inserting edge of lace.....
28934	2660	Edge Folder (right hand) and Slide complete, with left hand upper guide, for folding bobbinette curtains and inserting edge of lace.....
35080	2679	Edge Folder, to turn the goods in, use with 35081.....
35081	2679	Presser Foot (hinged) strip folding, with tape guide, for 35080.....
35300	8679	Edge Folder (left hand) on Slide complete, to turn edge under with right hand lower guide, for turning silk bolting cloth and stitching cotton webbing and ticking.....
35994	5794	Edge Folder (double) on Slide 18114.....
18114	8673	" " Slide.....

STRIP FOLDERS

No.	Plate	Name
*26412	----	Strip Folder.....
18114	8673	" " Slide.....
26413	8679	" " on Slide, Nos. 18114 and 26412.....
Note: When ordering No. 26413, give gauge required		
35102	2681	Strip Folder on Slide 18114, for folding strip so that both edges will meet in center, for belt loops for trousers.....
35103	2681	Presser Foot (tube) for 35102.....
35132	8679	Strip Folder on Slide 18114 to turn both edges up, so that the edges will meet in center, for garters.....
35133	2686	Presser Foot (strip folding) to turn under both edges 1/4 in., for garters, for 35132.....
35702	1251	Strip Folder on Slide 18114 with lining guide, for making side straps for trousers.....

STRIP FOLDERS

No.	Plate	Name
35703	1251	Presser Foot for 35702.....
35801	1254	Strip Folder on Slide 18114, with guides for steel and interlining.....
26276	8667	Presser Foot Hinge Pin.....
35802	----	" " Plate for 35804.....
35803	----	" " Shank for 35804.....
35804	1254	Presser Foot (hinged) complete for 35801 Nos. 26276, 35802 and 35803.....
35878	1254	Strip Folder on Slide 18114, with guide for interlining.....
36077	5796	Strip Folder on Slide 18114, for light material, for making straps.....
36078	5796	Presser Foot for 36077.....

STRIP FOLDER

FOR MACHINE NO. 31-52

No.	Plate	Name
120193	8661	Feed Dog, 12 teeth (16 teeth to the inch) with 19118, for 120195 and 120196...
19118	8672	Feed Dog Spring Hook.....
120194	8661	Presser Foot for 120196.....
120195	8661	Throat Plate for 1/2 in. to 3/4 in. gauge for 120193 and 120196.....
18114	8673	Strip Folder Slide.....
120196	8661	" " on 18114, for hemming the right hand edge and turning over the left hand edge, for army shirts.....

STRIP FOLDER

FOR MACHINE NO. 31-62

No.	Plate	Name
36490	8679	Edge Guide.....
1443B	8647	" " Screw.....
36491	8679	Strip Folder (lower) on Slide.....
36492	8679	" " (upper) on Bracket.....
1425B	8647	" " Screw.....
793B	8647	" " Thumb Screw.....

STRIP FOLDER

No.	Plate	Name
36493	8679	Strip Folder (lower and upper) complete with Edge Guide, for banding knee pants, Nos. 793B, 1425B, 1443B and 36490 to 36492.....
36606	8655	Feed Dog, 21 teeth (16 teeth to the inch) with 19118, for 36493 and 36607.....
36494	8654	Feed Dog, 21 teeth (16 teeth to the inch) with 19118, for 36493 and 36496.....
19118	8672	Feed Dog Spring Hook.....
36495	8655	Lifting Presser Foot for 36493.....
36496	8654	Throat Plate, for 17/32 in. to 13/16 in. gauge, for 36493 and 36494.....
36607	8655	Throat Plate, for 3/8 in. to 1/2 in. gauge, for 36493 and 36606.....
36497	8655	Vibrating Presser Foot for 36493.....

GUIDES

GUIDE

FOR MACHINE NO. 31-52

No.	Plate	Name
19230	8679	Guide.....
207F	8647	" Screw for 19230.....
7071	8647	" " Washer for 19230.....

GUIDES (Hinged)

FOR CLOSING FRONT SEAMS ON STRAIGHT FRONT CORSETS

No.	Plate	Name
36224	2059	Guide (right hand) for 35287.....
36225	2059	" " " Hinge Plate for 35287
50094D	2059	" " " Screw for 35287
35287	2059	Guide (hinged) right hand complete, Nos. 36224, 36225 and 50094D.....
35288	2059	Presser Foot with guide on bottom to the left of needle holes, for 35287.....
36226	2059	Guide (left hand) for 35289.....
36227	2059	" " " Hinge Plate for 35289.

LAP SEAM FELLERS

No.	Plate	Name
20387	8657	Feed Dog, 16 spiked teeth (16 teeth to the inch) with 19118, for heavy lap seam feller, for 20388.....
19118	8672	Feed Dog Spring Hook.....
*26269	----	Folder for 26272.....
18114	8673	" Slide.....
19294	8647	" " Spring.....
405E	8647	" " Screw.....
26272	8681	Lap Seam Feller (right hand) complete, Nos. 18114 and 26269.....
*26396	----	Folder for 26397.....
26397	8681	Lap Seam Feller (left hand) complete, Nos. 18114 and 26396.....
36880	8681	Lap Seam Feller (left hand) on Slide 18114, to fold top only.....
26565	2071	Lap Seam Feller (right hand) on Slide 18114, to fold top only.....
26276	8667	Presser Foot Hinge Pin.....
26382	----	" " Plate.....
26395	----	" " Shank.....
26383	8656	Presser Foot (hinged) complete, for X heavy, XX heavy and XXX heavy lap seam feller, Nos. 26276, 26382 and 26395.....
26276	8667	Presser Foot Hinge Pin.....
35195	----	" " Plate.....
26275	----	" " Shank.....
35196	8656	Presser Foot (hinged) complete, for 3/32 in. to 3/8 in. gauge, for light medium and heavy lap seam feller, Nos. 26275, 26276 and 35195.....
19147	8650	Shuttle Race Slide Friction Spring.....
651E	8650	" " " " Screw.....
19189	8681	" " " Guide (front) with 651E and 19147.....
914F	8647	Shuttle Race Slide Guide Screw for 19189
19190	8656	Throat Plate, for 7/32 in. to 1/2 in. gauge, for 19340 and 24482.....
20077	797	Throat Plate, for 17/32 in. to 13/16 in. gauge, for 20076.....
20089	800	Throat Plate, for 27/32 in. to 1 1/4 in. gauge, for 20088.....
20104	800	Throat Plate, for 3/32 in. to 1/8 in. gauge, for 20103.....
20196	8657	Throat Plate, for 3/16 in. to 1/2 in. gauge, for 20195.....
19283	788	Throat Plate, for 15/64 in. to 9/16 in. gauge, for 19274.....

LAP SEAM FELLERS

No.	Plate	Name
19289	788	Throat Plate, for 3/32 in. to 3/8 in. gauge, for 19344.....
43965	2082	Throat Plate, for 3/16 in. to 5/16 in. gauge, for 20086.....
20388	8657	Throat Plate, for 33/64 in. to 13/16 in. gauge, for 20387.....

PRESSER FEET

No.	Plate	Name
26404	1224	Presser Foot (tube) for reeding.....
26276	8667	" " Hinge Pin.....
26405	----	" " Plate.....
26275	----	" " Shank.....
26406	1224	Presser Foot (tube) hinged complete, for reeding, Nos. 26275, 26276 and 26405.
26407	1224	Presser Foot, for double strips (tube) for reeding.....
26408	1224	Presser Foot, for double strips (tube)..
26276	8667	" " Hinge Pin.....
26409	----	" " Plate.....
26275	----	" " Shank.....
26410	1224	Presser Foot, for double strips (tube) hinged, complete, Nos. 26275, 26276 and 26409.....
26411	8666	Presser Foot (strip folding) for cording
26414	8666	" " " " opening seams and enclosing folded edges....
26415	8666	Presser Foot (strip folding) for short strips.....
36089	5797	Presser Foot (strip folding) for long strips.....
26416	8666	Presser Foot (strip folding) with guide, for opening seams.....
26276	8667	Presser Foot Hinge Pin.....
26417	----	" " Plate.....
26275	----	" " Shank.....
26418	8666	Presser Foot (strip folding) hinged, complete, with guide for opening seams, Nos. 26275, 26276 and 26417....
26276	8667	Presser Foot Hinge Pin.....
26518	----	" " Plate.....
26275	----	" " Shank.....
26519	2679	Presser Foot (hinged, tube) complete, for double strips, for reeding, Nos. 26275, 26276 and 26518.....

No.	Plate	Name
26574	8666	Presser Foot, for gathering.....
26887	5646	" " (strip folding) with two tubes, for stitching two rows of soutache braid on the folded strip..
26278	8667	Presser Foot Hinge Pin.....
28801	----	" " Plate.....
26275	----	" " Shank.....
28802	8666	Presser Foot (hinged) strip folding, complete, Nos. 26275, 26276 and 28801...
28995	2670	Presser Foot, for braiding.....
35071	2670	" " (strip folding) for folding strip and inserting piping on each edge of strip.....
35083	2681	Presser Foot (strip folding) for straight cut goods, to turn under the right and left edges 5/16 in., with guide, for interlining.....
35111	2670	Presser Foot with upper and lower strip folder, for 1/4 in. to 5/8 in. gauge.
35194	5646	Presser Foot, for gathering.....
35259	2679	" " (strip folding) with tape guide.....
35362	8666	Presser Foot with upper and lower strip folder.....
35542	1003	Presser Foot (tube) for strip, with two tubes for braid, to stitch braid to each edge of strip.....
35835	8666	Presser Foot (strip folding) with tongue slotted for interlining and guide, for steel.....
26276	8667	Presser Foot Hinge Pin.....
35885	----	" " Plate.....
35886	----	" " Shank.....
35887	5797	Presser Foot (strip folding) hinged, complete, with guide for draw string, Nos. 26276, 35885 and 35886.....
26276	8667	Presser Foot Hinge Pin.....
36295	----	" " Plate.....
20048	----	" " Shank.....
26231	8667	" " Spring.....
36296	1003	Presser Foot (tube) spring hinged, complete, with guide, for opening seams, Nos. 20048, 26231, 26276 and 36295..
36297	5798	Presser Foot with upper and lower strip folder, for 11/16 in. to 1 1/4 in. gauge.....
120157	8665	Presser Foot (double tube) for two strips.....

PRESSER FOOT EXTENSIONS

No.	Plate	Name
19216	8668	Presser Foot with 228D.....
26279	8668	" " Extension, 1/16 in., for 19216.....
26280	8668	Presser Foot Extension, 1/8 in., for 19216.....
26281	8668	Presser Foot Extension, 1/4 in., for 19216.....
26282	8668	Presser Foot Extension, 3/8 in., for 19216.....
26283	8668	Presser Foot Extension, 1/2 in., for 19216.....
228D	8212	Presser Foot Extension Screw.....

PRESSER FOOT STRIP GAUGE

No.	Plate	Name
19216	8668	Presser Foot with 228D.....
25967	8668	" " Strip Gauge for 19216.....
228D	8212	" " " " Screw.....

QUILTERS

No.	Plate	Name
28659	8681	Quilter Guide for 28660.....
25992	8681	" " Holder with two 207F.....
207F	8647	" " " Set Screw.....
207F	8647	" " " Set Screw.....
28660	8681	Quilter complete, Nos. 25992 and 28659..
120479	8212	" Guide (left) for 120485.....
120480	8212	" " (right) for 120485.....
120481	8212	" " Bracket for 120482.....
120482	----	" " 120481 with 120483 and two 209C, for 120485.....
209C	8212	Quilter Guide Bracket Set Screw.....
120483	8212	" " Disengaging Sleeve for 120482.....
120484	8212	Quilter Guide Disengaging Sleeve Spring.....
602D	8647	" " " " " " Screw.....
209C	8212	Quilter Guide Set Screw.....
120485	----	Quilter complete, Nos. 602D, 120479, 120480, 120482 and 120484.....

RUFFLERS

RUFFLER No. 35305

RUFFLER (POWER) WITH LEVER FOR THROWING RUFFLING
BLADE INTO ACTION, FOR INTERMITTENT RUFFLING,
FOR SHIRT YOKINGS, ETC.

No.	Plate	Name
28590	2070	Driving Lever.....
1101C	2070	" " Hinge Screw.....
1847C	2070	" " " Nut.....
28591	2070	" " Spring.....
28592	2070	" " Collar.....
35302	2070	Frame.....
35306	----	Needle Clamp Body.....
28228	2069	" " Roller.....
209F	8212	" " Screw.....
35307	2069	Needle Clamp complete, Nos. 28228, 35306 and two 209F.....
35303	2070	Presser Foot.....
185H	2070	" " Screw.....
35304	2070	Ruffling Blade.....
24203	2070	" " Holder.....
226J	2070	" " " Cap Screw.....
24204	2070	" " " Spring.....
24205	2070	" " " Stop.....
24206	2070	" " Stud.....
1550H	2070	" " " Nut.....
28607	2070	" " " Stop.....
28600	2070	" " Lever.....
580B	2070	" " Adjusting Thumb Screw.....
1603E	2070	Ruffling Blade Lever Adjusting Thumb Screw Nut.....
1049D	2070	Ruffling Blade Lever Stop Screw.....
665J	2070	" " Screw.....
28601	2070	Starting Lever with 190D.....
190D	2070	" " Clamping Screw.....
35305	2069	Ruffler complete for 35308, Nos. 185H, 226J, 580B, 1049D, 1101C, 1550H, 1603E, 1647C, 24203 to 24206, 28590 to 28592, 28600, 28601, 28607, 35302 to 35304, 35307 and two 665J.....
35311	2072	Edge Folder (left hand) on Slide com- plete, to turn the goods up with separating blade and right hand up- per guide, for 35305.....
36321	2662	Feed Dog, 16 teeth (16 teeth to the inch) with 19118, for 35305 and 36322.....

No.	Plate	Name
36323	2663	Feed Dog, 16 teeth (16 teeth to the inch) with 19118, for 35305 and 36324.....
35312	2072	Ruffling Blade for 35311.....
35308	2071	Strip Folder on Slide 18114, with upper right hand edge folder to turn the goods under, with separating blade and guide, for draw string, for 35305
35309	2071	Strip Folder on Slide 18114, with separ- ating blade and guide, for draw string, for 35305.....
18114	8673	Strip Folder Slide.....
35310	2071	" Guide on Slide 18114, with guide, for draw string, for 35305.....
18114	8673	Strip Guide Slide.....
36322	2662	Throat Plate, for 17/32 in. to 13/16 in. gauge, for 35305 and 36321.....
36324	2663	Throat Plate, for 27/32 in. to 1 1/4 in. gauge, for 35305 and 36323.....

RUFFLER No. 35812

RUFFLER (POWER) WITH LEVER FOR THROWING RUFFLING
BLADE INTO ACTION, FOR INTERMITTENT RUFFLING,
FOR SHIRT YOKINGS, ETC.

No.	Plate	Name
28590	2070	Driving Lever.....
1101C	2070	" " Hinge Screw.....
1647C	2070	" " " Nut.....
28591	2070	" " Spring.....
28592	2070	" " Collar.....
28593	1255	Frame.....
35306	----	Needle Clamp Body.....
28228	2069	" " Roller.....
209F	8212	" " Screw.....
35307	2069	Needle Clamp complete, Nos. 28228, 35306 and two 209F.....
35807	1255	Presser Foot (left).....
185H	2070	" " " Screw.....
62527	8650	" " (right) Hinge Pin.....
35808	----	" " Plate.....
28596	----	" " " Shank.....
28597	1255	" " " Cap.....
198D	1255	" " " Screw....
2656	1255	" " " Spring.....
706J	1255	" " " Stop Screw...

No.	Plate	Name
2521	1255	Presser Foot (right) Spring.....
35809	1255	Presser Foot (right) complete, Nos. 2521 28598, 35808 and 62527.....
35810	1255	Ruffling Blade.....
24203	2070	" " Holder.....
228J	2070	" " " Cap Screw.....
24204	2070	" " " Spring.....
24205	2070	" " " Stop.....
24206	2070	" " " Stud.....
1550H	2070	" " " Nut.....
28607	2070	" " " Stop.....
35811	1255	" " Lever.....
560B	2070	" " Adjusting Thumb Screw.....
1603E	2070	Ruffling Blade Lever Adjusting Thumb Screw Nut.....
1049D	2070	Ruffling Blade Lever Stop Screw.....
665J	2070	" " Screw.....
28601	2070	Starting Lever with 190D.....
190D	2070	" " Clamping Screw.....
35812	1255	Ruffler complete for 35813, Nos. 185H, 226J, 560B, 706J, 1049D, 1101C, 1550H, 1603E, 1647C, 2656, 24203 to 24206, 28590 to 28593, 28597, 28601, 28607, 35307, 35807, 35809 to 35811, two 665J and three 198D.....
35813	1256	Double Edge Folder (right hand) with separating blade, for ruffling shirt body and putting in yoke, for 35812.
35814	8663	Feed Dog, 8 teeth (16 teeth to the inch) with 19118, for 35812 and 35815.....
19118	8672	Feed Dog Spring Hook.....
35815	8663	Throat Plate, for 3/16 in. to 3/8 in. gauge, for 35812 and 35814.....

RUFFLER No. 36004

RUFFLER (POWER) WITH LEVER FOR THROWING RUFFLING
BLADE INTO ACTION, FOR INTERMITTENT RUFFLING,
FOR SHIRT YOKINGS, ETC.

No.	Plate	Name
28590	2070	Driving Lever.....
1101C	2070	" " Hinge Screw.....
1647C	2070	" " " Nut.....

No.	Plate	Name
28591	2070	Driving Lever Spring.....
28592	2070	" " " Collar.....
35302	2070	Frame.....
35306	----	Needle Clamp Body.....
28228	2069	" " Roller.....
209F	8212	" " Screw.....
35307	2069	Needle Clamp complete, Nos. 26228, 35306 and two 209F.....
35303	2070	Presser Foot.....
185H	2070	" " Screw.....
36002	5795	Ruffling Blade.....
24203	2070	" " Holder.....
226J	2070	" " " Cap Screw.....
24204	2070	" " " Spring.....
24205	2070	" " " Stop.....
24206	2070	" " " Stud.....
1550H	2070	" " " Nut.....
28607	2070	" " " Stop.....
36003	5795	" " Lever.....
560B	2070	" " Adjusting Thumb Screw.....
1603E	2070	Ruffling Blade Lever Adjusting Thumb Screw Nut.....
1049D	2070	Ruffling Blade Lever Stop Screw.....
665J	2070	" " Screw.....
28601	2070	Starting Lever with 190D.....
190D	2070	" " Clamping Screw.....
36004	5795	Ruffler complete for 35308, Nos. 185H, 226J, 560B, 1049D, 1101C, 1550H, 1603E, 1647C, 24203 to 24206, 28590 to 28592, 28601, 28607, 35302, 35303, 35307, 36002, 36003 and two 665J.....
18114	8673	Strip Folder Slide.....
35308	2071	" " on Slide 18114, with upper right hand edge folder to turn the goods under, with separating blade and guide for draw string, for 36004

SHIRT CLOSING PARTS

FOR MACHINE NO. 31-52

No.	Plate	Name
20317	8662	Feed Dog, 15 teeth (16 teeth to the inch) with 19118, for 20318.....
19118	8672	Feed Dog Spring Hook.....
26487	8662	Hemmer (foot) for felling.....
6267	8662	" Folder for 26487.....

No.	Plate	Name
25888	8662	Hemmer Tongue for 26487.....
Note: When ordering Nos. 6267 or 25888, give width of hem and No. of Hemmer for which it is required.		
20318	8662	Throat Plate, for 1/32 in. to 1/4 in. gauge, with 2653, for 20317.....
26488	8662	Throat Plate Cloth Guide.....
102D	8662	" " " " Hinge Screw....
2653	8662	" " " " Stop Pin.....
26489	8662	" " Spring Guide.....
240D	8662	" " " " Screw.....

THROAT PLATES AND FEED DOGS

FOR MACHINE NO. 31-52

No.	Plate	Name
26725	1328	Feed Dog, 10 teeth (16 teeth to the inch) with 19118, for 26726, 36310, 36311 and 36543.....
19118	8672	Feed Dog Spring Hook.....
26726	1328	Throat Plate, for 5/32 in. to 1/2 in. gauge, for under strip, for 26725....
36310	2086	Throat Plate, for 5/32 in. to 1/2 in. gauge, for two under strips, for 26725.....
36311	2086	Throat Plate, for 5/32 in. to 1/2 in. gauge, for two under strips, with adjustable under strip guide, for 26725.....
36543	8660	Throat Plate, for 5/32 in. to 1/2 in. gauge, with adjustable under strip guide, for 26725.....
36312	2086	Feed Dog, 10 teeth (16 teeth to the inch) with 19118, for 36313 to 36316.....
19118	8672	Feed Dog Spring Hook.....
36313	2086	Throat Plate, for 17/32 in. to 13/16 in. gauge, for under strip, for 36312...
36314	5800	Throat Plate, for 17/32 in. to 13/16 in. gauge, for two under strips, for 36312.....
36315	5800	Throat Plate, for 17/32 in. to 13/16 in. gauge, with adjustable under strip guide, for 36312.....

No.	Plate	Name
36316	8660	Throat Plate, for 17/32 in. to 13/16 in. gauge, for two under strips, with adjustable under strip guide, for 36312.....
36317	5802	Feed Dog, 10 teeth (16 teeth to the inch) with 19118, for 36318.....
19118	8672	Feed Dog Spring Hook.....
36318	5802	Throat Plate, for 53/64 in. to 1 1/4 in. gauge, for under strip, for 36317...

SPOOL HOLDER

(DISC)

No.	Plate	Name
26763	8670	Bracket with 219F and 50053D.....
219F	5773	" Screw.....
50053D	8663	" Thumb Screw.....
19066	8670	Spindle.....
19067	8670	" Thread Guiding Disc.....
691F	8650	" " " " Screw.....
26784	8670	Spool Holder complete, Nos. 691F, 19066, 19067 and 26763.....

TAPE HOLDERS

TAPE HOLDER

(5 IN. DISC)

No.	Plate	Name
36795	2116	Tape Holder Body.....
36796	2116	" " Cover.....
55D	8663	" " Hinge Screw.....
28994	2116	Tape Holder complete, Nos. 55D, 36795, 36796 and two wood screws 1 1/4 in. No. 10.....

TAPE HOLDER

(8 IN. DISC)

No.	Plate	Name
26061	989	Bracket Wire with Disc.....
26062	989	Disc (adjustable) with 35925 and 51224D.

TAPE HOLDER

No.	Plate	Name
35925	8663	Disc Hub.....
51224D	8645	" " Thumb Screw.....
26325	8669	Foot with 736J and three wood screws 1 in. No. 12.....
736J	8663	Foot Screw.....
26063	989	Tape Holder (straight) complete for 26065, Nos. 26061 and 26062.....
26065	----	Tape Holder with Foot complete, Nos. 26063 and 26325.....

TAPE HOLDER
(10 IN. DISC)

No.	Plate	Name
26066	989	Bracket Wire.....
26067	----	Bracket Wire complete, Nos. 26066, 26068 and 26072.....
26068	989	Disc.....
26069	989	" Hub.....
26070	----	" Rivet for 26071.....
26071	----	Disc complete, Nos. 26068 and 26069.....
26064	8669	Foot with 736J and three wood screws 1 in. No. 12.....
736J	8663	Foot Screw.....
26072	989	Tape Guide.....
26073	8663	Tension Adjusting Collar with 51224E....
51224B	8645	" " " Thumb Screw....
13211	8663	" " " Spring.....
26074	989	Tape Holder (offset) complete for 26343, Nos. 13211, 26067, 26071 and 26073....
26343	----	Tape Holder with Foot complete, Nos. 26064 and 26074.....

TAPE SPOOL FIXTURE (Wire)

No.	Plate	Name
4516	8684	Tape Spool Fixture (wire) with fixed cone.....
4518	8684	Tape Spool Fixture Cone.....
1541B	8684	" " " Regulating Thumb Nut.
8019	8684	" " " Spring.....
4517	8684	Tape Spool Fixture (wire) with fixed cone complete, Nos. 1541B, 4516, 4518 and 8019.....

SPOOL FIXTURE (Wire)

No.	Plate	Name
4715	8684	Spool Fixture (wire) with two 10145.....
4717	8684	" " Flange.....
10145	8684	" " Thread Eyelet.....
4718	8684	" " Washer (felt).....
4716	8684	Spool Fixture complete, for two spools, Nos. 4715, two 4717 and three 4718..

FOOT LIFTER PARTS

No.	Plate	Name
5596	8682	Bell Crank.....
56848	----	" " 5596 with 5599 and 5601.....
5599	8682	" " Bracket.....
178E	8676	" " " Screw.....
5601	8676	" " Hinge Pin.....
5735	8682	" " Spring.....
5598	8682	Bell Crank complete, Nos. 5735 and 56848
5670	----	Chain, length 26 in. to 35 in. with 56864 and 56865.....
Note: When ordering No. 5670, state length required		
4879	8682	Chain Connecting Link for 4885.....
56864	8682	" Hook (large).....
56865	8682	" " (small).....
12237	8682	Lifting Lever with 448C, for 20008.....
20340	8682	" " " 448C, for 43928.....
12415	8682	" " Connecting Rod.....
12416	8682	" " " " " Joint.....
78D	8676	" " " " " Hinge Screw.....
1521E	8676	Lifting Lever Connecting Rod Lock Nut...
802D	8676	" " Hinge Screw.....
12241	8671	" " Link for 20008.....
21301	5773	" " " " 43928.....
766D	8671	" " " Hinge Screw.....
12240	8682	" " Pin for 20008.....
19372	5773	" " " " 43928.....
448C	8645	" " " " " Set Screw.....
2763	819	Rock Shaft.....
12242	819	" " Hanger with two wood screws 1 in. No. 10.....
6337	819	Rock Shaft Lifting Bracket with two 356C
12243	819	" " " " " Hook for 5598
7125	819	" " " " " " " 5670

FOOT LIFTER PARTS

No.	Plate	Name
356C	8671	Rock Shaft Lifting Bracket Hook Set Screw.....
356C	8671	Rock Shaft Lifting Bracket Set Screw....
2770	319	" " " Stop Dog with 356C.....
356C	8671	" " " " Set Screw.....
4880	819	Rock Shaft complete, Nos. 2763,2770,7125 12243 and two each 6337 and 12242...
4881	819	Treadle.....
4882	8682	" Shaft.....
4883	8682	" Spring.....
4884	819	" Stand.....
4885	819	Treadle complete, Nos. 4879,4881 to 4884 and two wood screws 1 in. No. 16....
20008	----	Foot Lifter complete for 31-52 Machine, Nos. 76D,766D,802D,1521E,4880,4885, 5598,5670,12237,12240,12241,12415, 12416 and two 178E.....
43928	----	Foot Lifter complete for 31-62 Machine, Nos. 76D,766D,802D,1521E,4880,4885, 5598,5670,12415,12416,19372,20340, 21301 and two 178E.....

KNEE LIFTER PARTS

No.	Plate	Name
5596	8682	Bell Crank.....
56848	----	" " 5596 with 5599 and 5601.....
5599	8682	" " Bracket.....
178E	8676	" " " Screw.....
5601	8676	" " Hinge Pin.....
5735	8682	" " Spring.....
5598	8682	Bell Crank complete, Nos. 5735 and 56848
12237	8682	Lifting Lever with 448C, for 12445 and 20466.....
20340	8682	Lifting Lever with 448C, for 20341 and 43931.....
12415	8682	Lifting Lever Connecting Rod.....
12416	8682	" " " " " Joint.....
76D	8676	" " " " " Hinge Screw.....
1521E	8676	Lifting Lever Connecting Rod Lock Nut....
802D	8676	" " Hinge Screw.....
12241	8671	" " Link for 12445 and 20466..
21301	5773	" " " 20341 and 43931..
766D	8671	" " Hinge Screw.....
12240	8682	" " Pin for 12445 and 20466...

KNEE LIFTER PARTS

No.	Plate	Name
19372	5773	Lifting Lever Pin for 20341 and 43931...
448C	8645	" " " Set Screw.....
2763	819	Rock Shaft for 12250.....
20091	8688	" " " 20465.....
7539	8688	" " Hanger with two wood screws 1 in. No. 10, for 12250.....
2764	8688	Rock Shaft Hanger (back) with two wood screws 1 in. No. 10, for 20465.....
16128	8688	Rock Shaft Hanger (front) with two wood screws 1 in. No. 10, for 20465.....
2765	8688	Rock Shaft Knee Arm.....
2766	8688	" " " " Hub with 356C, for 2768.....
20462	8688	Rock Shaft Knee Arm Hub with 356C, for 20463.....
356C	8671	Rock Shaft Knee Arm Hub Set Screw.....
2768	----	Rock Shaft Knee Arm complete for 12250, Nos. 2765 to 2767.....
20463	----	Rock Shaft Knee Arm complete for 20465, Nos. 2765, 2767 and 20462.....
2767	8688	Rock Shaft Knee Plate with 356C.....
356C	8671	" " " " Set Screw.....
20464	8688	" " Lifting Arm with 356C for 20465.....
356C	8671	Rock Shaft Lifting Arm Set Screw.....
6337	819	" " " Bracket with two 356C for 12250.....
2778	8688	Rock Shaft Lifting Bracket Hook for 12250.....
356C	8671	Rock Shaft Lifting Bracket Hook Set Screw.....
356C	8671	Rock Shaft Lifting Bracket Set Screw....
2770	819	" " Stop Dog with 356C.....
356C	8671	" " " " Set Screw.....
12250	8688	Rock Shaft complete for 12445 and 120341 Nos. 2763,2768,2778,6337 and two each 2770 and 7539.....
20465	8688	Rock Shaft complete for 20466 and 43931, Nos. 2764,16128,20091,20463,20464 and two 2770.....
12445	----	Knee Lifter complete (power table or stand No. 25265) for 31-52 Machine, Nos. 76D,766D,802D,1521E,5598,12237, 12240,12241,12250,12415,12416 and two 178E.....
20341	----	Knee Lifter complete (power table or stand No. 25265) for 31-62 Machine, Nos. 76D,766D,802D,1521E,5598,12250, 12415,12416,19372,20340,21301 and two 178E.....

No.	Plate	Name
20466	----	Knee Lifter complete (stand No. 25255) for 31-52 Machine, Nos. 76D,766D, 802D,1521E,5598,12237,12240,12241, 12415,12416,20465 and two 178E.....
43931	----	Knee Lifter complete (stand No. 25255) for 31-62 Machine, Nos. 76D,766D, 802D,1521E,5598,12415,12416,19372, 20340,20465,21301 and two 178E.....

THREAD UNWINDER

FOR TWO SPOOLS OR TWO LARGE CONES OF THREAD

No.	Plate	Name
225257	20335	Spool Rest with 201018C.....
150203	20335	" " Cushion (felt).....
225388	20335	" " Rod.....
200383C	8671	" " Set Screw.....
201018C	8671	" " Set Screw.....
202490	20335	" Stand with 200383C.....
225391	20335	Thread Guide.....
201696J	8671	" Lock Nut.....
225326	20335	" Position Cup.....
225324	20335	" Rod with 208E and 225322..
208E	8671	" Screw.....
225322	8671	" Washer.....
225258	20335	Thread Unwinder complete, Nos. 201696J, 202490,225257,225324,225326,225388, two each 150203,225391 and three wood screws 7/8 in. No. 12.....
27739	8670	Thread Cone (wood) for large cones.....
225390	8670	" Holder, for inverted cones..

Note: Nos. 27739 and 225390 are used with, but not included in 225258.

WRENCHES

No.	Plate	Name
19221	8680	Wrench for 936 and 1619.....
8909	8680	" " 1513 and 1518.....
8908	8680	" " 1520.....

NUMERICAL LIST OF PARTS

No.	Plate	Name
32D	8647	Bobbin Winder Frame Hinge Screw for 12172, 19260 and 20309.....
35D	8647	Bobbin Winder Stop Latch Hinge Screw for 27875.....
55D	8663	Tape Holder Cover Hinge Screw for 28994.
65D	8674	Driving Arm Pitman Hinge Screw for 20141
75D	8674	Bobbin Winder Stop Latch Hinge Screw for 19260.....
76D	8676	Lifting Lever Connecting Rod Joint Hinge Screw for 12445,20008,20341,20466, 43928 and 43931.....
102D	8662	Throat Plate Cloth Guide Hinge Screw for 31-52 Machine, for shirt closing parts.....
106D	1245	Presser Foot Shank Hinge Connection Screw for 35560.....
134D	8650	Tension Plate Screw.....
144D	8645	Arm Shaft Screw.....
145D	8645	" Spool Bracket Screw.....
145F	8645	Shuttle Race Screw.....
152F	8674	Bobbin Winder Stop Latch Adjusting Screw for 19258.....
157E	8672	Feed Lifting Rock Shaft Crank (front) Clamping Screw for 19120.....
157J	8672	Feed Rock Shaft Crank Clamping Screw for 29633.....
158C	8675	Bed Frame Cushion Screw for 20067.....
175D	8650	Lifting Presser Bar Guide Bracket Support Screw for 31-62 Machine.....
178E	8676	Bell Crank Bracket Screw for 12445,20008 20341,20466,43928 and 43931.....
180F	8647	Bobbin Winder Spring Screw for 12172, 19260 and 20309.....
185H	2070	Presser Foot (left) Screw for 35812.....
185H	2070	" Screw for 35305 and 36004..
190D	2070	Face Plate Screw for 31-52 Machine.....
190D	2070	Presser Foot Screw.....
190D	2070	Ruffler Starting Lever Clamping Screw for 28601.....
191C	8653	Feed Dog Screw.....
193D	5773	Lifting Presser Foot Screw for 31-62 Machine.....
193F	5773	Stay Guide Screw for 26268.....

No.	Plate	Name
198D	1255	Presser Foot (right) Shank Cap Screw for 35812.....
199D	5772	Lifting Presser Bar Bell Crank Cap Screw for 43956.....
199D	5772	Lifting Presser Bar Bell Crank Connecting Link Cap Screw for 43956.....
199F	5772	Vibrating Presser Bar Cap Screw for 43949.....
207F	8647	Guide Screw for 19230.....
207F	8647	Quilter Guide Holder Set Screw for 25992
207F	8647	" " Set Screw for 25992.....
208E	8671	Thread Unwinder Thread Guide Rod Screw for 225324.....
209F	8212	Needle Set Screw for 19276.....
209F	8212	Ruffler Needle Clamp Screw for 35307....
209C	8212	Quilter Guide Bracket Set Screw for 120482.....
209C	8212	Quilter Guide Set Screw for 120482.....
210D	8674	Driving Attachment Balance Wheel Oil Cover Screw for 20141.....
211E	8675	Bed Frame Hinge Connection Cap Screw for 19398.....
217D	5773	Vibrating Presser Bar Foot Screw for 31-62 Machine.....
219D	5773	Arm Side Cap Screw.....
219F	5773	Face Plate Screw for 31-62 Machine.....
219F	5773	Spool Holder Bracket Screw for 26763....
219F	5773	Vibrating Presser Bar Cap Screw for 19367.....
220D	1245	Presser Foot Cap Screw for 35560.....
226D	2070	Oscillating Shaft Crank Slide Block Cap Screw for 19390.....
226J	2070	Ruffling Blade Holder Cap Screw for 35305,35812 and 36004.....
228D	8212	Presser Foot Extension Screw for 19216..
228D	8212	" " Strip Gauge Screw for 19216
240D	8662	Throat Plate Spring Guide Screw for 19484,20392,24450 and for shirt closing parts.....
307C	8672	Feed Lifting Rock Shaft Screw Center....
307C	8672	" Rock Shaft Screw Center.....
313C	8672	" Bar Screw Center.....
333D	8647	Bobbin Winder Friction Wheel Washer Screw for 12171,16515 and 20308.....
335D	5773	Vibrating Presser Bar Spring Screw for 31-62 Machine.....
356C	8671	Rock Shaft Knee Arm Hub Set Screw for 2766 and 20462.....

No.	Plate	Name
356C	8671	Rock Shaft Knee Plate Set Screw for 2767
356C	8671	" " Lifting Arm Set Screw for 20464.....
356C	8671	Rock Shaft Lifting Bracket Hook Set Screw for 6337.....
356C	8671	Rock Shaft Lifting Bracket Set Screw for 6337.....
356C	8671	Rock Shaft Stop Dog Set Screw for 2770..
361C	8674	Driving Attachment Treadle Pitman Rod Clamp Screw for 80223.....
362C	8674	Driving Attachment Treadle Stop Collar Set Screw for 2762.....
375C	5772	Feed Connecting Link Hinge Screw.....
375C	5772	" Forked Connection Hinge Screw.....
375C	5772	" Lifting Rock Shaft Crank Connecting Rod Hinge Screw.....
375C	5772	Lifting Presser Bar Bell Crank Driving Arm Eccentric Connection Hinge Screw for 31-62 Machine.....
405E	8647	Lap Seam Feller Folder Slide Spring Screw.....
418E	8647	Bobbin Winder Tension Screw Stud for 27308.....
427E	8674	Driving Arm Friction Plug Adjusting Screw for 19260.....
435C	8671	Driving Attachment Balance Wheel Set Screw for 16592.....
435C	8671	Thread Take-up Lever Link Hinge Pin Set Screw.....
446C	8672	Feed and Feed Lifting Eccentric Set Screw for 19275.....
448C	8645	Arm Shaft Flanged Bushing (back) Set Screw.....
448C	8645	Balance Wheel Set Screw for 4370 and 12358.....
448C	8645	Lifting Lever Pin Set Screw for 12237 and 20340.....
448C	8645	Needle Bar Crank and Lifting Eccentric Set Screw for 19365.....
448C	8645	Oscillating Rock Shaft Hinge Pin Set Screw.....
448C	8645	Thread Take-up Spring Regulator Set Screw.....
453C	8646	Lifting Presser Bar Guide Bracket Set Screw for 24589.....
453C	8646	Needle Bar Connecting Stud Set Screw for 12384.....
453C	8646	Presser Bar Guide Bracket Set Screw for 12326.....

No.	Plate	Name
453C	8646	Shuttle Driver Set Screw for 19139.....
457C	8646	Oscillating Shaft Crank Set Screw for 19388.....
462C	8672	Feed Lifting Rock Shaft Crank (back) Set Screw for 3043J.....
560B	2070	Ruffling Blade Lever Adjusting Thumb Screw for 35305, 35812 and 36004....
591F	8651	Shuttle (inside) Tension Regulating Screw for 19312.....
591F	8651	Shuttle (outside) Tension Regulating Screw for 19313.....
592E	8651	Shuttle (inside) Bobbin Case Latch and Position Finger Stop Screw for 19312
592E	8651	Shuttle (outside) Bobbin Case Latch and Position Finger Stop Screw for 19313
597C	8674	Driving Attachment Shaft Driving Pulley Clamping Screw for 27072.....
802D	8647	Quilter Guide Disengaging Sleeve Spring Screw for 120485.....
651E	8650	Shuttle Race Slide Friction Spring Screw for 19148, 19185 and 19189.....
651E	8650	Shuttle Race Slide Guide (front) Spring Screw for 35301.....
665J	2070	Ruffling Blade Screw for 35305, 35812 and 36004.....
688E	8682	Pressure Regulating Thumb Screw.....
689C	8646	Lifting Presser Bar Lifter Screw for 31-62 Machine.....
689C	8646	Presser Bar Lifter Screw.....
690E	1144	Thread Take-up Crank Wedge Screw.....
691F	8650	Shuttle Race Slide Guide Screw.....
691F	8650	Spool Holder Spindle Thread Guiding Disc Screw for 26764.....
691F	8650	Throat Plate Screw.....
692D	8647	Bobbin Winder Bracket Screw for 12172 and 20141.....
693D	8683	Driving Arm Hinge Screw for 19260.....
706J	1255	Presser Foot (right) Shank Stop Screw for 35812.....
736J	8663	Tape Holder Foot Screw for 26064 and 26325.....
743C	5773	Needle Bar Crank and Lifting Eccentric Position Screw for 19365.....
748E	8645	Arm Screw (back).....
766D	8671	Lifting Lever Link Hinge Screw for 12445 20008, 20341, 20466, 43928 and 43931...
775E	1144	Thread Take-up Lever Cap Screw.....
793B	8647	Strip Folder (upper) Thumb Screw for 36493.....

No.	Plate	Name
794E	1144	Needle Bar Connecting Link Adjusting Screw for 12362.....
802D	8676	Lifting Lever Hinge Screw for 12445, 20008, 20341, 20466, 43928 and 43931...
816D	8672	Feed Regulator Thumb Screw.....
854E	8645	Arm Screw (front).....
858C	8646	Needle Bar Crank Set Screw for 20188....
861D	8647	Driving Friction Pulley Oil Hole Plug Screw for 16594.....
878D	8646	Oscillating Rock Shaft Hinge Pin Oil Hole Stop Screw.....
896C	8645	Crank Connecting Rod Cap Screw for 20197
905D	8671	Thread Guide Screw for 19162.....
907D	8650	Shuttle Race Ring Spring Screw for 19323 24013 and 24493.....
908C	8645	Crank Connecting Rod Hinge Screw.....
914F	8647	Shuttle Race Slide Guide Screw for 19189
916C	1146	Tension Screw Stud for 44209.....
936E	8646	Needle Bar Screw Bushing.....
965D	5773	Lifting Presser Bar Bell Crank Driving Arm Shaft Bracket Screw for 31-62 Machine.....
966E	8672	Feed Lifting Rock Shaft Crank Connecting Rod Cap Screw for 43976.....
969C	8646	Oscillating Shaft Crank Slide Block Screw Stud for 19390.....
1049D	2070	Ruffling Blade Lever Stop Screw for 35305, 35812 and 36004.....
1053D	1241	Shuttle Race Needle Guard Screw for 19323, 24013 and 24493.....
1065C	8646	Needle Bar Crank Position Screw for 20188.....
1101C	2070	Ruffler Driving Lever Hinge Screw for 35305, 35812 and 36004.....
1128E	8672	Feed Regulator Hinge Screw.....
1425B	8647	Strip Folder (upper) Screw for 36493....
1443B	8647	Edge Guide Screw for 36493.....
1508C	8674	Driving Arm Friction Plug Adjusting Screw Nut for 19260.....
1513E	8672	Feed Lifting Rock Shaft Screw Center Nut
1513E	8672	" Rock Shaft Screw Center Nut.....
1518E	5772	" Connecting Link Hinge Screw Nut....
1518E	5772	" Forked Connection Hinge Screw Nut..
1518E	5772	" Lifting Rock Shaft Crank Connecting Rod Hinge Screw Nut.....
1518E	5772	Oscillating Shaft Crank Slide Block Screw Stud Nut for 19388.....
1519E	8672	Feed Bar Screw Center Nut.....

NUMERICAL LIST OF PARTS

No.	Plate	Name
1520E	8646	Lifting Presser Bar Lifter Screw Nut for 31-62 Machine.....
1520E	8646	Presser Bar Lifter Screw Nut.....
1521E	8676	Lifting Lever Connecting Rod Lock Nut for 12445, 20008, 20341, 20466, 43928 and 43931.....
1541B	8684	Tape Spool Fixture Regulating Thumb Nut for 4517.....
1547D	1146	Tension Screw Stud Nut for 19195.....
1550H	2070	Bobbin Winder Stop Latch Adjusting Screw Nut for 19258.....
1550H	2070	Ruffling Blade Holder Stud Nut for 35305 35812 and 36004.....
1560C	1146	Tension Regulating Thumb Nut for 44209..
1562J	8647	Bobbin Winder Tension Regulating Thumb Nut for 27308.....
1579C	8683	Driving Arm Hinge Screw Nut for 19260...
1603E	2070	Ruffling Blade Lever Adjusting Thumb Screw Nut for 35305, 35812 and 36004.
1619E	8645	Crank Connecting Rod Hinge Screw Nut....
1620J	8676	Bobbin Winder Frame Hinge Screw Nut for 27875.....
1647C	2070	Ruffler Driving Lever Hinge Screw Nut for 35305, 35812 and 36004.....
1904	1144	Needle Bar Connecting Stud Roller (roller only) for 12384.....
2022	8674	Driving Arm Pitman Crank Pin for 44176..
2022	8674	Driving Attachment Starting Crank Pin for 44176.....
2049	5772	Feed Lifting Rock Shaft Crank (back) Pin
2049	5772	Lifting Presser Bar Bell Crank Driving Arm Pin for 19361.....
2049	5772	Oscillating Shaft Crank Pin.....
2049	5772	Shuttle Driver Pin.....
2102	8676	Bobbin Winder Tension Disc for 225462...
2106	8647	" " " Thread Guide for 27308.....
2269	1146	Bobbin Winder Stop Latch Stop Pin for 16518.....
2269	1146	Tension Releasing Lever (intermediate) Hinge Pin for 19195.....
2273	8646	Needle Clamp Pin.....
2415	8648	Arm Spool Bracket for 15063.....
2455	8647	Bobbin Winder Tension Disc for 27308....
2521	1255	Presser Foot (right) Spring for 35809...
2521	1255	Shuttle (inside) Bobbin Case Latch and Position Finger Spring for 19312....
2521	1255	Shuttle (outside) Bobbin Case Latch and Position Finger Spring for 19313....

NUMERICAL LIST OF PARTS

No.	Plate	Name
2532	1245	Shuttle Race Ring Position Pin for 19323 24013 and 24493.....
2533	8664	Shuttle Race Ring Spring for 19323, 24013 and 24493.....
2653	8662	Throat Plate Cloth Guide Stop Pin for 20318.....
2656	1255	Presser Foot (right) Shank Spring for 35812.....
2762	8687	Driving Attachment Treadle Stop Collar with 362C, for 14233.....
2763	819	Rock Shaft for 4880 and 12250.....
2764	8688	Rock Shaft Hanger (back) with two wood screws 1 in. No. 10, for 20465.....
2765	8688	Rock Shaft Knee Arm for 2768 and 20463..
2766	8688	" " " " Hub with 356C, for 2768.....
2767	8688	Rock Shaft Knee Plate with 356C, for 2768 and 20463.....
2768	----	Rock Shaft Knee Arm complete for 12250, Nos. 2765 to 2767.....
2770	819	Rock Shaft Stop Dog with 356C, for 4880, 12250 and 20465.....
2778	8688	Rock Shaft Lifting Bracket Hook for 12250.....
2921	1146	Tension Disc for 19195.....
2923	1146	" Spring for 19195.....
2928	8674	Driving Arm Brake (leather) for 16518...
3033	8672	Feed Connecting Link.....
3039	8649	" Regulator.....
3043J	8664	" Lifting Rock Shaft Crank (back) with 462C, for 20015.....
3094	1144	Thread Take-up Crank Wedge.....
4370	8677	Balance Wheel (stand) heavy rim 2 3/4 in. pulley, with two 448C.....
4515	8682	Throat Plate Spring Guide for 19481.....
4516	8684	Tape Spool Fixture (wire) with fixed cone for 4517.....
4517	8684	Tape Spool Fixture (wire) with fixed cone complete, Nos. 1541B, 4516, 4518 and 8019.....
4518	8684	Tape Spool Fixture Cone for 4517.....
4715	8684	Spool Fixture (wire) with two 10145, for 4716.....
4716	8684	Spool Fixture (wire) complete, for two spools, Nos. 4715, two 4717 and three 4718.....
4717	8684	Spool Fixture Flange for 4716.....
4718	8684	" " Washer (felt) for 4716....
4784	8646	Oscillating Rock Shaft Oil Pad for 19387

No.	Plate	Name
4855	5772	Lifting Presser Bar Lifter for 31-62 Machine.....
4879	8682	Chain Connecting Link for 4885.....
4880	819	Rock Shaft complete for 20008 and 43928, Nos. 2763, 2770, 7125, 12243 and two each 6337 and 12242.....
4881	819	Treadle for 4885.....
4882	8682	" Shaft for 4885.....
4883	8682	" Spring for 4885.....
4884	819	" Stand for 4885.....
4885	819	Treadle complete for 20008 and 43928, Nos. 4879, 4881 to 4884 and two wood screws 1 in. No. 16.....
5598	8682	Bell Crank for 56848.....
5598	8682	Bell Crank complete for 12445, 20008, 20341, 20486, 43928 and 43931, Nos. 5735 and 56848.....
5599	8682	Bell Crank Bracket for 56848.....
5601	8676	" " Hinge Pin for 56848.....
5670	----	Chain, length 26 in. to 35 in. with 56864 and 56865, for 20008 and 43928
5735	8682	Bell Crank Spring for 5598.....
5960	8685	Bobbin Winder Friction Wheel (leather) for 12171, 16515 and 20308.....
5961	8685	Bobbin Winder Friction Wheel Washer for 12171, 16515 and 20308.....
5963	8685	Bobbin Winder Spindle Flange for 12171, 16515 and 20308.....
6055	8675	Driving Attachment Treadle Pitman Rod (lower) Spring Washer for 14233.....
6055	8675	Machine Hinge Bolt Nut Washer for 44180 (Attachments and Accessories).....
6267	8662	Hemmer Folder for 28487, for shirt closing parts, for 31-52 Machine.....
6337	819	Rock Shaft Lifting Bracket with two 3560 for 4880 and 12250.....
7071	8647	Guide Screw Washer for 19230.....
7071	8647	Stay Guide Screw Washer for 26268.....
7125	819	Rock Shaft Lifting Bracket Hook for 4880 and 5670.....
7308	1245	Presser Foot Bracket for 35560.....
7309	1245	" " Cap for 35560.....
7310	1245	" " Shank Hinge Connection for 35580.....
7311	1245	Presser Foot Shank Pin for 35558 and 35559.....
7336	8671	Thread Take-up Spring Regulator.....
7539	8688	Rock Shaft Hanger with two wood screws 1 in. No. 10, for 12250.....

No.	Plate	Name
7958	8674	Driving Attachment Balance Wheel Friction Ring Stop Pin for 16592.....
8019	8684	Tape Spool Fixture Spring for 4517.....
8418	8686	Belt Guard Button for 8420.....
8419	8647	" " " Washer (leather) for 8420.....
8420	----	Belt Guard Button 8418 with 8419 and wood screws 1 1/4 in. No. 9 R.H.B., for 41931.....
8582	8645	Arm Dowel Pin.....
8908	8680	Wrench for 1520 (Attachments and Accessories).....
8909	8680	Wrench for 1513 and 1518 (Attachments and Accessories).....
10141	8647	Bobbin Winder Tension Spring for 27308..
10145	8684	Spool Fixture Thread Eyelet for 4715....
10236	8674	Driving Friction Pulley Center Bearing for 16594.....
*11104	----	Arm Shaft Bushing (front) for 20013 and 43948.....
11119	8645	Arm Oil Tube 15733 with 52045, for oiling 19156.....
11187	8664	Lifting Presser Bar Spring (light) .051 wire, for 31-62 Machine.....
11187	8664	Presser Bar Spring (light) .051 wire....
11170	8646	Lifting Presser Bar Spring Washer for 31-62 Machine.....
11170	8646	Presser Bar Spring Washer.....
11204	1144	Thread Take-up Lever Link Hinge Pin.....
11241	8681	Arm Spool Bracket Spool Pin Washer (cloth).....
11241	8681	Bobbin Winder Spool Washer (cloth) for 27308.....
12139	8664	Lifting Presser Bar Spring (medium) .055 wire, for 31-62 Machine.....
12139	8664	Presser Bar Spring (medium) .055 wire...
12149	8671	Thread Guard for 19162.....
12152	8672	Face Plate Thread Guard (lower) Rivet for 19327.....
12152	8672	Face Plate Thread Guard (upper) Rivet for 19155.....
12166	1144	Thread Take-up Lever Hinge Pin for 19157
12168	8685	Bobbin Winder Bracket for 12172 and 20309.....
12169	8685	Bobbin Winder Frame for 12171.....
12170	8685	" " Spring for 12172, 19280 and 20309.....

NUMERICAL LIST OF PARTS

No.	Plate	Name
12171	8685	Bobbin Winder Frame complete for 12172, Nos. 333D, 5960, 5961, 5963, 12169 and 15077.....
12172	----	Bobbin Winder complete for 4370, Nos. 32D, 180F, 12168, 12170 and 12171.....
12178	8674	Driving Arm Friction Plug (wood) for 19260.....
12193	8648	Arm Side Cover.....
12237	8682	Lifting Lever with 448C, for 12445, 20008 and 20466.....
12240	8682	Lifting Lever Pin for 12445, 20008 and 20466.....
12241	8671	Lifting Lever Link for 12445, 20008 and 20466.....
12242	819	Rock Shaft Hanger with two wood screws 1 in. No. 10, for 4880.....
12243	819	Rock Shaft Lifting Bracket Hook for 4880 and 5598.....
12250	8688	Rock Shaft complete, for 12445 and 20341 Nos. 2763, 2768, 2778, 6337 and two each 2770 and 7539.....
12326	8646	Presser Bar Guide Bracket with 453C.....
12327	8671	Lifting Presser Bar Lifting and Releasing Lever Bracket, for 31-62 Machine
12327	8671	Presser Bar Lifting and Releasing Lever Bracket.....
12329	8650	Tension Releasing Lever Spring.....
12357	8649	Arm Shaft Flanged Bushing (back).....
12358	8677	Balance Wheel (power) light rim 2 3/16 in. pulley, with two 448C.....
12361	8675	Machine Hinge Connection for 44140 and 44180 (Attachments and Accessories).
12374	8677	Feed Lifting Rock Shaft for 20015.....
12379	8677	" Rock Shaft for 20333.....
*12382	1144	Needle Bar Connecting Link with 794E....
*12383	----	" " Stud for 12384....
12384	1144	Needle Bar Connecting Stud complete, Nos. 453C, 1904 and 12383.....
12388	8649	Oscillating Rock Shaft Hinge Pin for 19387.....
12391	8664	Lifting Presser Bar (hollow) for 31-62 Machine.....
12391	8664	Presser Bar (hollow).....
12398	8650	Tension Releasing Lever Hinge Pin.....
12403	8681	Arm Spool Bracket Spool Pin and Thread Eyelet for 15063.....
12405	8675	Machine Rest (felt) Attachments and Accessories.....
12409	1144	Thread Take-up Lever Link for 19157.....

NUMERICAL LIST OF PARTS

No.	Plate	Name
12415	8682	Lifting Lever Connecting Rod for 12445, 20008, 20341, 20466, 43928 and 43931...
12416	8682	Lifting Lever Connecting Rod Joint for 12445, 20008, 20341, 20466, 43928 and 43931.....
12424	8646	Oscillating Shaft Crank Slide Block Cap Screw Washer for 19390.....
12427	8677	Arm Shaft.....
12429	8648	Feed Forked Connection.....
12445	----	Knee Lifter complete (power table or stand No. 25285) for 31-52 Machine, Nos. 76D, 766D, 802D, 1521E, 5598, 12237, 12240, 12241, 12250, 12415, 12416 and two 178E.....
12453	8645	Arm Oil Tube for intermediate bearing...
12454	8645	" " " with 132590, for oiling 12409.....
12458	8687	Drip Pan with four 1 in. wire nails for 20141.....
12459	8646	Oscillating Rock Shaft Hinge Pin Oil Hole Stop Screw Washer (leather)....
12475	8687	Driving Arm Pitman for 20141.....
12477	8683	" Attachment Starting Crank Shaft, for 44176.....
12479	8683	Driving Attachment Starting Crank for 44176.....
12480	8649	Arm Side Cap.....
13211	8663	Tape Holder Tension Adjusting Spring for 26074.....
14010	8675	Bed Frame Hinge Plate Rivet for 20067...
14081	8687	Driving Attachment Treadle Pitman Rod (upper) for 14233.....
14233	8687	Driving Attachment Treadle Pitman complete, for 126213, Nos. 2762, 6055, 14081, 27637, 80223 and 150208.....
15063	8648	Arm Spool Bracket 2415 with two 12403...
15072	8647	Bobbin Winder Bobbin Position Pin for 15077 and 27538.....
15077	8685	Bobbin Winder Spindle with 15072, for 12171, 16515 and 20308.....
15132	8674	Driving Arm Brake Rivet for 16518.....
*15404	----	Trade Mark for 20013 and 43948.....
15405	----	" " Rivet for 20013 and 43948....
15783	----	Arm Oil Tube for 11119.....
16128	8688	Rock Shaft Hanger Front with two wood screws 1 in. No. 10, for 20465.....
16514	8685	Bobbin Winder Frame for 16515.....

NUMERICAL LIST OF PARTS

No.	Plate	Name
16515	8685	Bobbin Winder Frame complete, for 19260, Nos. 333D, 5960, 5961, 5963, 15077 and 16514.....
16518	8687	Driving Arm with 2269, 2928 and two 15132, for 19260.....
16524	----	Driving Attachment Balance Wheel Friction Ring (leather) for 16592.....
16530	8685	Driving Attachment Bracket for 19260....
16555	8675	Bed Frame Hinge Plate for 20067.....
16592	8687	Driving Attachment Balance Wheel (friction) with 7958, 16524 and two 435C, for 20141.....
16594	8683	Driving Friction Pulley, 2 5/16 in. diam. with 861D and 10236, for 20141.....
18014	8664	Needle Bar (hollow).....
18055	8667	Presser Foot Hinge Pin for 20131.....
18114	8673	Binder Slide for 35691 to 35693.....
18114	8673	Edge Folder Slide for 35994.....
18114	8673	Lap Seam Feller Folder Slide for 26272, 26397, 26565 and 36880.....
18114	8673	Strip Folder Slide for 26413, 35102, 35132 35308, 35309, 35702, 35801, 35878, 36077 and 120196.....
18114	8673	Strip Guide Slide for 35310.....
19066	8670	Spool Holder Spindle for 26764.....
19067	8670	" " " Thread Guiding Disc for 26764.....
19111	8649	Feed Bar.....
19116	8672	" Dog Spring.....
19117	8672	" " " Hook for 19120.....
19118	8672	" " " " 19274, 19338, 19339, 19340, 19341, 19343, 19344, 19479, 19482, 20068, 20072, 20074, 20076, 20084, 20086, 20088, 20103, 20195, 20279, 20294, 20316, 20317, 20373, 20383, 20387, 20391, 24449, 24462, 26725, 35694, 35814, 36312, 36317, 36321, 36323, 36494, 36606 and 120293.....
19120	8649	Feed Lifting Rock Shaft Crank (front) with 157E, 19117, 19121 and 19122, for 20015.....
19121	8672	Feed Lifting Rock Shaft Crank (front) Roller for 19120.....
19122	8672	Feed Lifting Rock Shaft Crank (front) Roller Pin for 19120.....
19128	8665	Presser Foot, for general work.....
19131	8651	Shuttle (inside) Bobbin for 19324.....
19131	8651	" (outside) Bobbin for 19325 and 19326.....

NUMERICAL LIST OF PARTS

No.	Plate	Name
19136	8651	Shuttle (inside) Body for 19324.....
19137	8650	" (outside) Body for 19325.....
19139	8664	" Driver with two 453C.....
19145	8673	" Race Slide (inside).....
19146	8673	" " (outside) for 7/16 in. gauge and below.....
19147	8650	Shuttle Race Slide Friction Spring for 19148, 19185 and 19189.....
19147	8650	Shuttle Race Slide Guide (front) Spring for 35301.....
19148	8673	Shuttle Race Slide Guide (back) with 651E and 19147.....
19149	8651	Shuttle (inside) Tension Spring for 19312.....
19155	----	Face Plate Thread Guard (upper) 62624 with 12152, for 19305 and 20395.....
19156	1144	Thread Take-up Lever for 19157.....
19157	1144	Thread Take-up Lever complete, Nos. 12166 12409 and 19156.....
19158	8671	Thread Take-up Spring (music wire).....
19159	8671	" Guide Body for 19162.....
19160	8671	" " Roller for 19162.....
19161	8671	" " Cap for 19162.....
19162	----	Thread Guide complete (roller) Nos. 905D and 19159 to 19161.....
19171	8650	Shuttle (outside) Body for 19326.....
19172	8650	" " Tension Spring for 19313.....
19185	8673	Shuttle Race Slide Guide (front) with 651E and 19147.....
19189	8681	Shuttle Race Slide Guide (front) with 651E and 19147, for lap seam feller.....
19190	8658	Throat Plate, for 7/32 in. to 1/2 in. gauge, for 19340 and 24462, for lap seam feller.....
19191	1146	Tension Plate for upper tension, with 19231, for 19195.....
19192	1146	Tension Releaser for 19195.....
19193	1146	" Releasing Lever (intermediate) for 19195.....
19194	1146	Tension Releasing Lever (intermediate) Spring for 19195.....
19195	1146	Tension (upper) complete with tension release, Nos. 2289, 19191, 19193, 19194 two each 1547D, 2923, 19192, 44209 and four 2921.....
19216	8668	Presser Foot with 228D, for strip gauge, for 25987.....
19219	8675	Bed Frame Cushion (leather) for 20067...

No.	Plate	Name
19220	8675	Bed Frame Cushion Spring for 20067.....
19221	8680	Wrench for 938 and 1619 (Attachments and Accessories).....
19226	8675	Bed Frame Hinge Connection for 19398....
19230	8679	Guide for 31-52 Machine.....
19231	1146	Tension Releasing Lever (intermediate) Hinge Block for 19191.....
19258	8683	Bobbin Winder Stop Latch with 152F and 1550H, for 19260.....
19260	----	Driving Arm complete for 20141, Nos. 32D 75D, 180F, 427E, 693D, 1508C, 1579C, 12170 12178, 16515, 16518, 16530, 19258 and 27303.....
19274	788	Feed Dog, 14 teeth (16 teeth to the inch) with 19118, for 19283, for lap seam feller.....
19275	8649	Feed and Feed Lifting Eccentric with 446C.....
19276	8646	Needle Clamp with two 209F.....
19281	8673	Shuttle Race Slide (outside) for 15/32 in. to 15/16 in. gauge.....
19283	788	Throat Plate, for 15/64 in. to 9/16 in. gauge, for 19274, for lap seam feller.....
19287	786	Throat Plate, for 1/32 in. to 3/16 in. gauge, for 19338.....
19288	786	Throat Plate, for 3/32 in. to 5/16 in. gauge, for 19339.....
19289	788	Throat Plate, for 3/32 in. to 3/8 in. gauge, for 19344, for lap seam feller.....
19290	789	Throat Plate, for 7/32 in. to 1/2 in. gauge, for 19343 and 35561.....
19291	789	Throat Plate, for 7/32 in. to 5/8 in. gauge, for 19341.....
19294	8647	Lap Seam Feller Folder Slide Spring.....
19304	----	Face Plate for 19305.....
19305	8649	Face Plate complete, for 31-52 Machine Nos. 19155, 19304 and 19327.....
19309	1213	Shuttle Race Needle Guard for 19323 and 24013.....
19310	8651	Shuttle (inside) Bobbin Case Latch and Position Finger for 19312.....
19311	8651	Shuttle (outside) Bobbin Case Latch and Position Finger for 19313.....
19312	8651	Shuttle (inside) Bobbin Case complete, for 19324, Nos. 591F, 592E, 2521, 19149 19310 and 62606.....

No.	Plate	Name
19313	8651	Shuttle (outside) Bobbin Case complete, for 19325 and 19326, Nos. 591F, 592E, 2521, 19172, 19311 and 62608.....
19315	----	Shuttle Race Body with 19316, for 19323.
19316	1213	" " Loop Separator for 19315 and 24490.....
19317	1213	Shuttle Race Ring (inside) for 19323, 24013 and 24493.....
19318	1213	Shuttle Race Ring (outside) for 19323 and 24013.....
19323	1213	Shuttle Race complete, for 3/32 in. to 5/32 in. gauge, Nos. 19309, 19315, 19317, 19318, two each 907D, 1053D, 2533 and four 2532.....
19324	8651	Shuttle (inside) 1 11/16 in. diam., Nos. 19131, 19136 and 19312.....
19325	8650	Shuttle (outside) 1 11/16 in. diam. for 7/32 in. gauge and above, Nos. 19131 19137 and 19313.....
19326	8650	Shuttle (outside) 1 11/16 in. diam., for 1/32 in. to 13/64 in. gauge, Nos. 19131, 19171 and 19313.....
19327	8672	Face Plate Thread Guard (lower) with 12152, for 19305 and 20395.....
19338	786	Feed Dog, 13 teeth (16 teeth to the inch) with 19118, for 19287, for general work.....
19339	786	Feed Dog, 9 teeth (16 teeth to the inch) with 19118, for 19288, for general work.....
19340	8656	Feed Dog, 13 teeth (16 teeth to the inch) with 19118, for 19190, for lap seam feller.....
19341	789	Feed Dog, 16 teeth (16 teeth to the inch) with 19118, for 19291, for knit goods and general work.....
19343	789	Feed Dog, 14 teeth (16 teeth to the inch) with 19118, for 19290 and 35561, for general work.....
19344	786	Feed Dog, 14 teeth (16 teeth to the inch) with 19118, for 19289, for lap seam feller.....
19356	5772	Lifting Presser Bar Bell Crank for 43956
19357	5772	" " " " " Connecting Link for 43956.....
19358	5772	Lifting Presser Bar Bell Crank Driving Arm for 19361.....
19359	5772	Lifting Presser Bar Bell Crank Driving Arm Shaft for 19361.....

No.	Plate	Name
19360	8669	Lifting Presser Bar Bell Crank Driving Arm Shaft Bracket for 19361.....
19361	----	Lifting Presser Bar Bell Crank Driving Arm Shaft Bracket complete, for 31-62 Machine Nos.2049 and 19358 to 19360.....
19362	5772	Lifting Presser Bar Bell Crank Driving Arm Eccentric Connection for 31-62 Machine.....
19365	8669	Needle Bar Crank and Lifting Eccentric with 448C and 743C, for 31-62 Machine.....
19367	5773	Vibrating Presser Bar Cap for 31-62 Machine.....
19368	5773	Vibrating Presser Bar Cushion (rawhide), for 31-62 Machine.....
19369	5773	Vibrating Presser Bar Spring for 31-62 Machine.....
19372	5773	Lifting Lever Pin for 20341, 43928 and 43931.....
19379	----	Shuttle Race Body for 24013.....
19381	8664	" " Ring (outside) for 24493...
19385	8673	" " Slide (outside) for 31/32 in. to 1 1/4 in. gauge.....
*19386	8649	Oscillating Rock Shaft for 19387.....
19387	----	Oscillating Rock Shaft complete, Nos. 4784,12388 and 19386.....
19388	8646	Oscillating Shaft Crank complete, Nos. 457C, 1518E, 19390 and 19496.....
19389	8646	Oscillating Shaft Crank Slide Block for 19390.....
19390	----	Oscillating Shaft Crank Slide Block complete, for 19388, Nos. 226D,969C, 12424 and 19389.....
19397	8675	Bed Frame Hinge Connection Cap for 19398
19398	----	" " " 19228 with 211E and 19397, for 20067.....
19479	8658	Feed Dog, 7 teeth (16 teeth to the inch) with 19118, for 19481, for staying overgaiters.....
19480	8665	Presser Foot, for 19479, for staying overgaiters.....
19481	8658	Throat Plate with 4515, for 1/8 in. to 5/16 in. gauge, for 19479.....
19482	8659	Feed Dog,12 teeth (16 teeth to the inch) with 19118, for 19484, for rounding overgaiters.....
19483	8665	Presser Foot, for 19482, for rounding overgaiters.....

No.	Plate	Name
19484	8659	Throat Plate with 240D,19485,19486 and 25786, for 1/8 in. to 1/4 in. gauge, for 19482.....
19485	2085	Throat Plate Arm for 19484,20392 and 24450.....
19486	2085	Throat Plate Spring Guide for 19484, 20392 and 24450.....
19496	----	Oscillating Shaft Crank for 19388.....
20008	----	Foot Lifter complete, for 31-52 Machine Nos. 76D,766D,802D,1521E,4880, 4885, 5598, 5670, 12237,12240,12241,12415, 12416 and two 178E.....
*20013	----	Arm with 11104, 15404 and two 15405, for 31-52 Machine.....
*20014	----	Bed.....
20015	----	Feed Lifting Rock Shaft complete, Nos. 3043J, 12374 and 19120.....
20016	8677	Oscillating Shaft.....
20023	8664	Lifting Presser Bar Spring (heavy) .063 wire, for 31-62 Machine.....
20023	8664	Presser Bar Spring (heavy) .063 wire....
20044	----	" Foot Plate for 20045.....
20045	8667	Presser Foot (hinged) complete, Nos. 20044, 26275 and 26276.....
20046	8665	Presser Foot (tube).....
20047	----	" " Plate for 20049.....
20048	----	" " Shank for 20049, 36296 and 43895.....
20049	1224	Presser Foot (spring-hinged) tube, complete, Nos. 20047,20048,26231 and 26276.....
20050	1224	Presser Foot (tube) for taping.....
20052	1224	" " for outside stays and strips
20053	1224	" " (strip) for boning.....
20067	819	Bed Frame with two each 16555,19398, four each 19219,1922C, six each 14010 wood screws 1 1/4 in. No. 12 and eight 158C.....
20068	8653	Feed Dog,18 teeth (16 teeth to the inch) with 19118, for 20069, for boning and corset strips.....
20069	8653	Throat Plate, for 3/16 in. to 1/2 in. gauge, for 20068.....
20072	8653	Feed Dog,14 teeth (16 teeth to the inch) with 19118, for 20073.....
20073	8653	Throat Plate, for 3/16 in. to 1/2 in. gauge, for 20072.....
20074	797	Feed Dog,16 teeth (16 teeth to the inch) with 19118,for 20075, for knit goods and general work.....

No.	Plate	Name
20075	797	Throat Plate, for 17/32 in. to 13/16 in. gauge, for 20074.....
20076	797	Feed Dog, 13 teeth (16 teeth to the inch) with 19118, for 20077, for heavy lap seam feller.....
20077	797	Throat Plate, for 17/32 in. to 13/16 in. gauge, for 20076, for heavy lap seam feller.....
20079	8654	Throat Plate, for 17/32 in. to 13/16 in. gauge, for 20318.....
20081	8654	Throat Plate, for 3/32 in. to 1/4 in. gauge, for 20294.....
20084	799	Feed Dog, 14 teeth (16 teeth to the inch) with 19118, for 20085, for general work.....
20085	799	Throat Plate, for 27/32 in. to 1 1/4 in. gauge, for 20084.....
20086	799	Feed Dog, 9 teeth (16 teeth to the inch) with 19118, for 20087 and 43965, for heavy bolting cloth and lap seam feller.....
20087	799	Throat Plate, for 3/16 in. to 5/16 in. gauge, for 20086.....
20088	800	Feed Dog, 13 teeth (16 teeth to the inch) with 19118, for 20089, for heavy lap seam feller.....
20089	800	Throat Plate, for 27/32 in. to 1 1/4 in. gauge, for 20088, for heavy lap seam feller.....
20091	8688	Rock Shaft for 20465.....
20103	800	Feed Dog, 10 teeth (16 teeth to the inch) with 19118, for 20104 and 43964, for lap seam feller.....
20104	800	Throat Plate, for 3/32 in. to 1/8 in. gauge, for 20103, for lap seam feller
20129	----	Presser Foot Plate for 20131.....
20130	----	" " Shank for 20131.....
20131	8667	Presser Foot (hinged) complete, hollowed across bottom between needle holes and heel for riding seams, for general work, Nos. 18055, 20129 and 20130
20141	----	Driving Attachment with Bobbin Winder and Treadle complete, Nos. 210D, 692D, 12475, 16592, 16594, 19280, 20372, 24355, 27072, 27308, 44176, 126213 and two 65D.
20168	----	Presser Foot Plate for 20170.....
20169	----	" " Shank for 20170 and 44187..

No.	Plate	Name
20170	8667	Presser Foot (hinged) complete, 5/32 in. and above, for rounding overgaiters, Nos. 20168, 20169 and 26276.....
20171	8665	Presser Foot (tube) for cording and covering one cord with strip.....
20188	8649	Needle Bar Crank with 858C and 1065C, for 31-52 Machine.....
20195	8657	Feed Dog, 15 teeth (16 teeth to the inch) with 19118, for 20196, for lap seam feller.....
20196	8657	Throat Plate, for 3/16 in. to 1/2 in. gauge, for 20195, for lap seam feller.....
20197	8648	Crank Connecting Rod with two 896C.....
20279	2077	Feed Dog, 16 teeth (16 teeth to the inch) with 19118, for 20280, for knit goods and general work.....
20280	2077	Throat Plate, for 27/32 in. to 1 1/4 in. gauge, for 20279.....
20294	8659	Feed Dog, 15 teeth (16 teeth to the inch) with 19118, for 20081.....
20302	8665	Presser Foot with guide on bottom to the right of needle holes.....
20307	8665	Bobbin Winder Frame for 20308.....
20308	8665	Bobbin Winder Frame complete for 20309, Nos. 333D, 5960, 5961, 5963, 15077 and 20307.....
20309	----	Bobbin Winder complete, for 12358, Nos. 32D, 180F, 12168, 12170 and 20308.....
20316	8654	Feed Dog, 14 teeth (16 teeth to the inch) with 19118, for 20079.....
20317	8662	Feed Dog, 15 teeth (16 teeth to the inch) with 19118, for 20318, for shirt closing parts, for 31-52 Machine....
20318	8662	Throat Plate, for 1/32 in. to 1/4 in. gauge, with 2653, for 20317, for shirt closing parts, for 31-52 Machine.....
20333	----	Feed Rock Shaft complete, Nos. 12379 and 29633.....
20340	8662	Lifting Lever with 448C, for 20341, 43928 and 43931.....
20341	----	Knee Lifter complete, (power table or stand No. 25265) Nos. 76D, 768D, 802D, 1521E, 5598, 12250, 12415, 12416, 19372, 20340, 21301 and two 178E.....
20371	8683	Driving Arm Pitman Crank for 44176.....
20372	8683	" " " " Spring for 20141

No.	Plate	Name
20373	8652	Feed Dog, 10 teeth (16 teeth to the inch) with 19118, for 20375, for edge stitching on curves, for shirt bottoms.....
20374	8665	Presser Foot with guide on bottom to the right of needle holes, for 20373....
20375	8652	Throat Plate, for 3/32 in. to 3/16 in. gauge, for 20373.....
20383	8652	Feed Dog, 12 teeth (16 teeth to the inch) with 19118, for 20384.....
20384	8652	Throat Plate, for 3/32 in. to 3/16 in. gauge, for 20383.....
20387	8657	Feed Dog, 16 spiked teeth (16 teeth to the inch) with 19118, for 20388, for heavy lap seam feller.....
20388	8657	Throat Plate, for 33/64 in. to 13/16 in. gauge, for 20387, for heavy lap seam feller.....
20391	2085	Feed Dog, 16 teeth (16 teeth to the inch) with 19118, for 20392.....
20392	2085	Throat Plate with 240D, 19485, 19486, and 25786, for 17/32 in. gauge, for 20391 for under strip.....
20395	8670	Face Plate complete, for 31-62 Machine, Nos. 19155, 19327 and 20475.....
20462	8688	Rock Shaft Knee Arm Hub with 356C, for 20463.....
20463	----	Rock Shaft Knee Arm complete for 20465, Nos. 2765, 2767 and 20462.....
20464	8688	Rock Shaft Lifting Arm with 356C, for 20465.....
20465	8688	Rock Shaft complete, for 20466 and 43931 Nos. 2764, 16128, 20091, 20463, 20464 and two 2770.....
20466	----	Knee Lifter complete (stand No. 25255) for 31-52 Machine, Nos. 76D, 766D, 802D, 1521E, 5598, 12237, 12240, 12241, 12415, 12416, 20465 and two 178E.....
20475	----	Face Plate for 20395.....
20482	5773	Lifting Presser Foot for 31-62 Machine..
20483	5773	Vibrating Presser Bar Foot for 31-62 Machine.....
21301	5773	Lifting Lever Link for 20341, 43928 and 43931.....
23258	8674	Driving Attachment Treadle Bracket (left) Hook Friction Washer for 126206.....

No.	Plate	Name
24013	8664	Shuttle Race complete, for 11/64 in. gauge and above, Nos. 19309, 19317, 19318, 19379, two each 907D, 1053D, 2533 and four 2532.....
24129	1144	Thread Take-up Crank.....
24131	8645	Arm Oil Tube with 52045, for oiling 19275
24203	2070	Ruffling Blade Holder for 35305, 35812 and 36004.....
24204	2070	Ruffling Blade Holder Spring for 35305, 35812 and 36004.....
24205	2070	Ruffling Blade Holder Spring Stop for 35305, 35812 and 36004.....
24206	2070	Ruffling Blade Holder Stud for 35305, 35812 and 36004.....
24355	8683	Driving Attachment Balance Wheel Oil Cover for 20141.....
24449	8658	Feed Dog, 15 teeth (16 teeth to the inch) with 19118, for 24450, for rounding overgaiters.....
24450	8658	Throat Plate with 240D, 19485, 19486 and 25786, for 3/16 in. to 5/16 in. gauge for 24449.....
24462	8658	Feed Dog, 13 spiked teeth (16 teeth to the inch) with 19118, for 19190, for lap seam feller.....
24490	----	Shuttle Race Body with 19316, for 24493.
24492	1241	" " Needle Guard for 24493.....
24493	1241	Shuttle Race complete, for 1/32 in. to 5/64 in. gauge, Nos. 19317, 19381, 24490, 24492, two each 907D, 1053D, 2533 and four 2532.....
24589	8669	Lifting Presser Bar Guide Bracket with 453C, for 43956.....
24590	8669	Lifting Presser Bar Guide Bracket Support for 31-62 Machine.....
25786	2085	Throat Plate Arm Rivet for 19484, 20392 and 24450.....
25888	8662	Hemmer Tongue for 26487, for shirt closing parts, for 31-52 Machine.....
25967	8668	Presser Foot Strip Gauge for 19216.....
25992	8681	Quilter Guide Holder with two 207F, for 28600.....
26026	8680	Screw Driver (large) Attachments and Accessories.....
26061	989	Tape Holder Bracket Wire with Disc, for 28063.....
26062	989	Tape Holder Disc (adjustable) with 35925 and 51224D, for 26063.....

NUMERICAL LIST OF PARTS

No.	Plate	Name
26063	989	Tape Holder (straight) complete, for 26065, Nos. 26061 and 26062.....
26064	8669	Tape Holder Foot with 736J and three wood screws 1 in. No. 12, for 26343.
26065	----	Tape Holder with Foot (8 in. disc) complete, Nos. 26063 and 26325.....
26066	989	Tape Holder Bracket Wire for 26067.....
26067	----	Tape Holder Bracket Wire complete, for 26074, Nos. 26066, 26068 and 26072...
26068	989	Tape Holder Disc for 26067 and 26071....
26069	989	" " " Hub for 26071.....
26070	----	" " " Rivet for 26071....
26071	----	Tape Holder Disc complete for 26074, Nos. 26068 and 26069.....
26072	989	Tape Holder Tape Guide for 26067.....
26073	8663	" " " Tension Adjusting Collar with 51224B, for 26074.....
26074	989	Tape Holder (offset) complete, for 26343 Nos. 13211, 26067, 26071 and 26073....
26228	2069	Ruffler Needle Clamp Roller for 35307...
26231	8667	Presser Foot Spring for 20049, 36296, 43895 and 43975.....
26266	8661	Stay Guide Plate (lower) for 26268.....
26267	8661	" " " (upper) for 26268.....
26268	----	Stay Guide complete, Nos. 26266 and 26267
26269	----	Lap Seam Feller Folder for 26272.....
26272	8661	Lap Seam Feller (right hand) complete, Nos. 18114 and 26269.....
26275	----	Presser Foot Shank for 20045, 26406, 26410 26418, 26519, 28802 and 35196.....
26276	8667	Presser Foot Hinge Pin for 20045, 20049, 20170, 26383, 26406, 26410, 26418, 26519, 28802, 35196, 35804, 35887, 36296, 43895, 43975 and 44187.....
26279	8668	Presser Foot Extension, 1/16 in., for 19216.....
26280	8668	Presser Foot Extension, 1/8 in., for 19216.....
26281	8668	Presser Foot Extension, 1/4 in., for 19216.....
26282	8668	Presser Foot Extension, 3/8 in., for 19216.....
26283	8668	Presser Foot Extension, 1/2 in., for 19216.....
26325	8669	Tape Holder Foot with 736J and three wood screws 1 in. No. 12, for 26065.
26343	----	Tape Holder with Foot (10 in. disc) complete, Nos. 26064 and 26074.....
26382	----	Presser Foot Plate for 26383.....

NUMERICAL LIST OF PARTS

No.	Plate	Name
26383	8656	Presser Foot (hinged) complete, for X heavy, XX heavy and XXX heavy lap seam feller, Nos. 26276, 26382 and 26395.....
26395	----	Presser Foot Shank for 26383.....
26396	----	Lap Seam Feller Folder for 26397.....
26397	8661	Lap Seam Feller (left hand) complete, Nos. 18114 and 26396.....
26404	1224	Presser Foot (tube) for reeding.....
26405	----	" " " Plate for 26406.....
26406	1224	Presser Foot (tube) hinged complete, for reeding, Nos. 26275, 26276 and 26405.
26407	1224	Presser Foot, for double strips (tube) for reeding.....
26408	1224	Presser Foot, for double strips (tube)..
26409	----	" " " Plate for 26410.....
26410	1224	Presser Foot, for double strips (tube) hinged complete, Nos. 26275, 26276 and 26409.....
26411	8666	Presser Foot (strip folding) for cording
26412	----	Strip Folder for 26413.....
26413	8679	" " " on Slide, Nos. 18114 and 26412.....
26414	8666	Presser Foot (strip folding) for opening seams and enclosing folded edges....
26415	8666	Presser Foot (strip folding) for short strips.....
26416	8666	Presser Foot (strip folding) with guide for opening seams.....
26417	----	Presser Foot Plate for 26418.....
26418	8666	Presser Foot (strip folding) hinged complete, with guide for opening seams, Nos. 26275, 26276 and 26417.....
26485	8660	Screw Driver (small) Attachments and Accessories.....
26487	9662	Hemmer (foot) for felling, for shirt closing parts, for 31-52 Machine....
26488	8662	Throat Plate Cloth Guide for shirt closing parts, for 31-52 Machine.....
26489	8662	Throat Plate Spring Guide, for shirt closing parts, for 31-52 Machine....
26518	----	Presser Foot Plate for 26519.....
26519	2679	Presser Foot (hinged tube) complete, for double strips, for reeding, Nos. 26275, 26276 and 26518.....
26565	2071	Lap Seam Feller (right hand) on Slide 18114 to fold top only.....
26574	8666	Presser Foot for gathering.....

No.	Plate	Name
26725	1328	Feed Dog, 10 teeth (16 teeth to the inch) with 19118, for 26726, 36310, 36311 and 36543, for 31-52 Machine.....
26726	1328	Throat Plate, for 5/32 in. to 1/2 in. gauge, for under strip, for 26725, for 31-52 Machine.....
26763	8670	Spool Holder Bracket with 219F and 50053D, for 26764.....
26764	8670	Spool Holder (disc) complete, Nos. 691F, 19066, 19067 and 26763.....
26887	5646	Presser Foot (strip folding) with two tubes, for stitching two rows of soutache braid on the folded strip..
26965	2660	Edge Folder (left hand) on slide complete, with right hand upper guide, for folding bobbinette curtains and inserting edge of lace.....
27072	----	Driving Attachment Shaft Driving Pulley (sectional grooved) 12 in. diam., 1 3/16 in. bore, with two 597C, for 20141.....
27302	8669	Bobbin Winder Frame for 27875.....
27303	8676	" " " Spring for 27875....
27303	8676	" " " Stop Latch Spring for 19260.....
27306	8686	Bobbin Winder Spool Pin for 27308.....
27307	8686	" " " Stand for 27308.....
27308	8686	Bobbin Winder Spool Stand complete, for 20141 and 27876, Nos. 418E, 1562J, 2106, 10141, 11241, 27306, 27307 and two each 2455 and wood screws 1 in. No. 10.....
27538	8669	Bobbin Winder Spindle 27849 with 15072, 27850 and 41828, for 27875.....
27540	8669	Bobbin Winder Base for 27875.....
27541	8669	" " " Pulley for 27875.....
27587	8686	" " " Stop Latch for 27875.....
27637	8687	Driving Attachment Treadle Pitman Rod (lower) for 14233.....
27739	8670	Thread Cone (wood) for large cones, for 225258.....
*27849	----	Bobbin Winder Spindle for 27538.....
*27850	----	" " " Collar for 27538..
27875	----	" " " Nos. 35D, 1620J, 27302, 27303, 27538, 27540, 27541, 27587, 50356D and two wood screws 1 in. No. 7, for 27876.....

No.	Plate	Name
27876	----	Bobbin Winder (swinging automatic, right hand) complete, for 19131 for stand Nos. 27308 and 27875.....
28590	2070	Ruffler Driving Lever for 35305, 35812 and 36004.....
28591	2070	Ruffler Driving Lever Spring for 35305, 35812 and 36004.....
28592	2070	Ruffler Driving Lever Spring Collar for 35305, 35812 and 36004.....
28593	1255	Ruffler Frame for 35812.....
28596	----	Presser Foot (right) Shank for 35809....
28597	1255	" " " " Cap for 35812
28600	2070	Ruffling Blade Lever for 35305.....
28601	2070	Ruffler Starting Lever with 190D, for 35305, 35812 and 36004.....
28607	2070	Ruffling Blade Holder Stop for 35305, 35812 and 36004.....
28659	8681	Quilter Guide for 28660.....
28660	8681	Quilter complete, Nos. 25992 and 28659..
28801	----	Presser Foot Plate for 28802.....
28802	8666	Presser Foot (hinged) strip folding complete, Nos. 26275, 26276 and 28801...
28934	2660	Edge Folder (right hand) on slide complete, with left hand upper guide, for folding bobbinette curtains and inserting edge of lace.....
28994	2116	Tape Holder (5 in. disc) complete, Nos. 55D, 36795, 36796 and two wood screws 1 1/4 in. No. 10.....
28995	2670	Presser Foot, for braiding.....
29633	8664	Feed Rock Shaft Crank with 157J, for 20333.....
35071	2670	Presser Foot (strip folding) for folding strip and inserting piping on each edge of strip.....
35080	2679	Edge Folder to turn the goods in, use with 35081.....
35081	2679	Presser Foot (hinged) strip folding with tape guide, for 35080.....
35083	2681	Presser Foot strip folding for straight cut goods to turn under the right and left edges 5/16 in., with guide for interlining.....
35102	2681	Strip Folder on Slide 18114, for folding strip so that both edges will meet in the center, for belt loops for trousers.....
35103	2681	Presser Foot (tube) for 35102.....

NUMERICAL LIST OF PARTS

No.	Plate	Name
35111	2670	Presser Foot with upper and lower strip folder, for 1/4 in. to 5/8 in. gauge.
35132	8679	Strip Folder on Slide 18114 to turn both edges up, so that the edges will meet in center, for garters.....
35133	2686	Presser Foot (strip folding) to turn under both edges 1/4 in., for garters for 35132.....
35194	5646	Presser Foot, for gathering.....
35195	----	" " Plate for 35196.....
35198	8656	Presser Foot (hinged) complete, for 3/32 in. to 3/8 in. gauge, for light, medium and heavy lap seam feller, Nos. 26275, 26276 and 35195.....
35259	2679	Presser Foot (strip folding) with tape guide.....
35287	2059	Guide (hinged) right hand complete, for closing front seams on straight front corsets, Nos. 36224, 36225 and 50094D.
35288	2059	Presser Foot with guide on bottom to the left of needle holes, for 35287.....
35289	2059	Guide (hinged) left hand complete, for closing front seams on straight front corsets, Nos. 36226, 36227 and 50094D.
35290	2059	Presser Foot with guide on bottom to the right of needle holes, for 35289.....
35300	8679	Edge Folder (left hand) on slide complete, to turn edge under with right hand lower guide, for turning silk bolting cloth and stitching cotton webbing and ticking.....
35301	8679	Shuttle Race Slide Guide (front) with 651E and 19147, for 35287 and 35289..
35302	2070	Ruffler Frame for 35305 and 36004.....
35303	2070	Presser Foot for 35305 and 36004.....
35304	2070	Ruffling Blade for 35305.....
35305	2069	Ruffler (power) complete, with lever, for throwing ruffling blade into action, for intermittent ruffling, for shirt yokings, etc., for 35308, Nos. 185H, 226J, 560B, 1049D, 1101C, 1550H, 1603E, 1647C, 24203 to 24206, 28590 to 28592, 28600, 28601, 28607, 35302 to 35304, 35307 and two 665J.....
35306	----	Ruffler Needle Clamp Body for 35307.....
35307	2069	Ruffler Needle Clamp complete, Nos. 26228 35306 and two 209F, for 35305, 35812 and 36004.....

NUMERICAL LIST OF PARTS

No.	Plate	Name
35308	2071	Strip Folder on Slide 18114, with upper right hand edge folder to turn the goods under, with separating blade and guide for draw string, for 35305 and 36004.....
35309	2071	Strip Folder on Slide 18114 with separating blade and guide for draw string, for 35305.....
35310	2071	Strip Guide on Slide 18114, with guide for draw string, for 35305.....
35311	2072	Edge Folder (left hand) on Slide complete, to turn the goods up with separating blade and right hand upper guide, for 35305.....
35312	2072	Ruffling Blade for 35311.....
35362	8666	Presser Foot with upper and lower strip folder.....
35542	1003	Presser Foot (tube) for strip with two tubes for braid, to stitch braid to each edge of strip.....
35556	1245	Presser Foot (left) for 35560.....
35557	1245	" " (right) for 35560.....
35558	1245	" " Shank (left) with 7311 for 35560.....
35559	1245	Presser Foot Shank (right) with 7311 for 35560.....
35560	1245	Presser Foot (compensating) complete for 35561, Nos. 106D, 220D, 7308 to 7310, 35556 to 35559 and two 62527.....
35561	1245	Hemmer (double) on Slide, for 3/32 in. to 3/16 in. hem, for hemming two pieces in one operation for skirt ruffler, etc.....
35691	1248	Binder on Slide 18114, for 1/2 in. to 1 1/2 in. ribbon binding, for blankets, for 31-62 Machine.....
35692	8677	Binder on Slide 18114, for 1 9/16 in. to 2 1/2 in. ribbon binding, for blankets, for 31-62 Machine.....
35693	8677	Binder on Slide 18114, for 2 9/16 in. to 3 1/2 in. ribbon binding, for blankets, for 31-62 Machine.....
35694	1249	Feed Dog, 21 teeth (16 teeth to the inch) with 19118, for 35691 to 35693 and 35695.....
35695	1249	Throat Plate for 3/16 in. to 5/16 in. gauge, for 35691 to 35694.....
35696	1249	Lifting Presser Foot for 35691.....

NUMERICAL LIST OF PARTS

No.	Plate	Name
35697	1249	Vibrating Presser Foot for 35691.....
35698	1249	Lifting Presser Foot for 35692 and 35693
35699	1249	Vibrating Presser Foot for 35692 and 35693.....
35702	1251	Strip Folder on Slide 18114 with lining guide, for making side straps for trousers.....
35703	1251	Presser Foot for 35702.....
35801	1254	Strip Folder on Slide 18114 with guides, for steel and interlining.....
35802	----	Presser Foot Plate for 35804.....
35803	----	" " Shank for 35804.....
35804	1254	Presser Foot (hinged) complete, for 35801, Nos. 26276, 35802 and 35803....
35807	1255	Presser Foot (left) for 35812.....
35808	----	" (right) Plate for 35809....
35809	1255	Presser Foot (right) complete for 35812, Nos. 2621, 28596, 35808 and 62527.....
35810	1255	Ruffling Blade for 35812.....
35811	1255	" Lever for 35812.....
35812	1255	Ruffler (power) complete, with lever for throwing ruffling blade into action, for intermittent ruffling, for shirt yokings, etc., for 35813, Nos. 185H, 226J, 560B, 706J, 1049D, 1101C, 1550H, 1603E, 1647C, 2656, 24203 to 24206, 28590 to 28593, 28597, 28601, 28607, 35307, 35807, 35809 to 35811, two 665J and three 198D.....
35813	1256	Double Edge Folder (right hand) with separating blade, for ruffling shirt body and putting in yoke, for 35812.
35814	8663	Feed Dog, 8 teeth (16 teeth to the inch) with 19118, for 35812 and 35815.....
35815	8663	Throat Plate, for 3/16 in. to 3/8 in. gauge, for 35812 and 35814.....
35835	8666	Presser Foot (strip folding) with tongue slotted for interlining and guide for steel.....
35878	1254	Strip Folder on Slide 18114 with guide for interlining.....
35885	----	Presser Foot Plate for 35887.....
35886	----	" Shank for 35887.....
35887	5797	Presser Foot (strip folding) hinged, complete, with guide for draw string, Nos. 26276, 35885 and 35886.....
35925	8663	Tape Holder Disc Hub for 26062.....

NUMERICAL LIST OF PARTS

No.	Plate	Name
35945	5794	Edge Guide (double) on slide, left hand lower, right hand upper, slide grooved for taping.....
35994	5794	Edge Folder (double) on slide 18114.....
36002	5795	Ruffling Blade for 36004.....
36003	5795	" " Lever for 36004.....
36004	5795	Ruffler (power) complete, with lever, for throwing ruffling blade into action, for intermittent ruffling, for shirt yokings, etc., for 35308, Nos. 185H, 226J, 560B, 1049D, 1101C, 1550H, 1603E, 1647C, 24203 to 24206, 28590 to 28592, 28601, 28607, 35302, 35303, 35307, 36002, 36003 and two 665J.....
36077	5796	Strip Folder on slide 18114, for light material, for making straps.....
36078	5796	Presser Foot for 36077.....
36089	5797	" " (strip folding) for long strips.....
36224	2059	Guide (right hand) for 35287.....
36225	2059	" " Hinge Plate for 35287
36228	2059	" (left hand) for 35289.....
36227	2059	" " Hinge Plate for 35289.
36295	----	Presser Foot Plate for 36296.....
36296	1003	Presser Foot (tube) spring hinged complete, with guide for opening seams, Nos. 20048, 26231, 26276 and 36295....
36297	5798	Presser Foot with upper and lower strip folder, for 1 1/16 in. to 1 1/4 in. gauge.....
36310	2086	Throat Plate, for 5/32 in. to 1/2 in. gauge, for two under strips, for 26725, for 31-52 Machine.....
36311	2086	Throat Plate, for 5/32 in. to 1/2 in. gauge, for two under strips with adjustable under strip guide, for 26725, for 31-52 Machine.....
36312	2086	Feed Dog, 10 teeth (16 teeth to the inch) with 19118, for 36313 to 36316, for 31-52 Machine.....
36313	2086	Throat Plate, for 17/32 in. to 13/16 in. gauge, for under strip, for 36312, for 31-52 Machine.....
36314	5800	Throat Plate, for 17/32 in. to 13/16 in. gauge, for two under strips, for 36312, for 31-52 Machine.....
36315	5800	Throat Plate, for 17/32 in. to 13/16 in. gauge, with adjustable under strip guide, for 36312, for 31-52 Machine.

No.	Plate	Name
36316	8660	Throat Plate, for 17/32 in. to 13/16 in. gauge, for two under strips with adjustable under strip guide, for 36312, for 31-52 Machine.....
36317	5802	Feed Dog, 10 teeth (16 teeth to the inch) with 19118, for 36318, for 31-52 Machine.....
36318	5802	Throat Plate, for 53/64 in. to 1 1/4 in. gauge, for under strip, for 36317, for 31-52 Machine.....
36321	2662	Feed Dog, 6 teeth (16 teeth to the inch) with 19118, for 35305 and 36322.....
36322	2662	Throat Plate, for 17/32 in. to 13/16 in. gauge, for 35305 and 36321.....
36323	2663	Feed Dog, 6 teeth (16 teeth to the inch) with 19118, for 35305 and 36324.....
36324	2663	Throat Plate, for 27/32 in. to 1 1/4 in. gauge, for 35305 and 36323.....
36490	8679	Edge Guide for 36493.....
36491	8679	Strip Folder (lower) on Slide for 36493.
36492	8679	" " (upper) on Bracket for 36493.....
36493	8679	Strip Folder (lower and upper) complete, with edge guide, for 31-62 Machine, for banding knee pants, Nos. 793B, 1425B, 1443B and 36490 to 36492.....
36494	8654	Feed Dog, 21 teeth (16 teeth to the inch) with 19118, for 36493 and 36496.....
36495	8655	Lifting Presser Foot for 36493.....
36496	8654	Throat Plate, for 17/32 in. to 13/16 in. gauge, for 36493 and 36494.....
36497	8655	Vibrating Presser Foot for 36493.....
36543	8660	Throat Plate, for 5/32 in. to 1/2 in. gauge with adjustable under strip guide, for 26725, for 31-52 Machine.
36606	8655	Feed Dog, 21 teeth (16 teeth to the inch) with 19118, for 36493 and 36607.....
36607	8655	Throat Plate, for 3/8 in. to 1/2 in. gauge, for 36493 and 36606.....
36795	2116	Tape Holder Body for 28994.....
36796	2116	" " Cover for 28994.....
36880	8681	Lap Seam Feller (left hand) on Slide 18114 to fold top only.....
41400	8660	Machine Rest Pin (wood) Attachments and Accessories.....
41828	8647	Bobbin Winder Spindle Collar Pin for 27538.....
41929	8677	Belt Guard for 41931.....
41930	8686	" " Hinge for 41931.....

No.	Plate	Name
41931	----	Belt Guard complete, Nos. 8420, 41929, two 41930 and four wood screws 3/4 in. No. 9.....
43894	----	Presser Foot Plate for 43895.....
43895	8667	Presser Foot (spring hinged) tube complete, for taping Nos. 20048, 26231, 26276 and 43894.....
43928	----	Foot Lifter complete, for 31-62 Machine, Nos. 76D, 766D, 802D, 1521E, 4880, 4885, 5598, 5670, 12415, 12416, 19372, 20340, 21301 and two 178E.....
43931	----	Knee Lifter complete (stand No. 25255) for 31-62 Machine, Nos. 76D, 766D, 802D, 1521E, 5598, 12415, 12416, 19372, 20340, 20465, 21301 and two 178E.....
43944	8649	Tension Releasing Lever.....
*43948	----	Arm with 11104, 15404 and two 15405, for 31-62 Machine.....
43949	5773	Vibrating Presser Bar for 43956.....
43956	----	Lifting Presser Bar Guide Bracket complete, for 31-62 Machine, Nos. 19356, 19357, 24589, 43949 and three 199D....
43964	2082	Throat Plate (flush) for 3/32 in. to 1/8 in. gauge, for 20103.....
43965	2082	Throat Plate, for 3/16 in. to 5/16 in. gauge, for 20086, for lap seam feller.....
43973	----	Presser Foot Plate for 43975.....
43974	----	" " Shank for 43975.....
43975	8667	Presser Foot (spring hinged) complete, for bolting cloth, Nos. 26231, 26276, 43973 and 43974.....
43976	8648	Feed Lifting Rock Shaft Crank Connecting Rod (cast iron) with two 968E.....
44139	8675	Machine Hinge Plate for 44140 and 44180 (Attachments and Accessories).....
44140	----	Machine Hinge complete, Nos. 12361, 44139 and merlized wood screw 1 1/4 in. No. 14 (Attachments and Accessories)....
*44176	----	Driving Attachment Starting Crank Shaft 12477 with 12479, 20371 and two 2022, for 20141.....
44180	----	Machine Hinge complete, Nos. 8055, 12361, 44139 and 51075E (Attachments and Accessories).....
44186	----	Presser Foot Plate for 44187.....
44187	8667	Presser Foot (hinged) complete, for 1/8 in. gauge and below for rounding overgaiters, Nos. 20169, 26276 and 44186.....

NUMERICAL LIST OF PARTS

No.	Plate	Name
44209	----	Tension Screw Stud 916C with 1560C, for 19195.....
44212	8676	Drip Pan with four 1 in. wire nails.....
46681	8683	Driving Attachment Treadle Bracket (right) for 60502.....
50053D	8663	Spool Holder Bracket Thumb Screw for 26763.....
50094D	2059	Guide (left hand) Hinge Screw for 35289.
50094D	2059	" (right hand) Hinge Screw for 35287
50356D	8676	Bobbin Winder Frame Hinge Screw for 27875.....
51075E	8675	Machine Hinge Bolt with 51581E, for 44180 (Attachments and Accessories).
51224D	8645	Arm Side Cover Thumb Screw.....
51224D	8645	Face Plate Thumb Screw.....
51224D	8645	Tape Holder Disc Hub Thumb Screw for 26062.....
51224B	8645	Tape Holder Tension Adjusting Collar Thumb Screw for 26073.....
51581E	----	Machine Hinge Bolt Nut for 51075E (Attachments and Accessories).....
52016	8664	Presser Bar Lifter.....
52045	8645	Arm Oil Tube Packing (wick) for 11119 and 24131.....
56848	----	Bell Crank 5596 with 5599 and 5601, for 5598.....
56864	8682	Chain Hook (large) for 5670.....
56865	8682	" " (small) for 5670.....
60502	----	Driving Attachment Treadle Bracket (right) 46681 with two wood screws 1 in. No. 14, for 126209.....
62527	8650	Presser Foot Hinge Pin for 35560.....
62527	9650	" " (right) Hinge Pin for 35809
62606	----	Shuttle (inside) Bobbin Case for 19312..
62608	----	" (outside) Bobbin Case for 19313.
62624	8672	Face Plate Thread Guard (upper) for 19155.....
80223	8687	Driving Attachment Treadle Pitman Rod Clamp with 361C, for 14233.....
120157	8665	Presser Foot (double tube) for two strips.....
120193	8661	Feed Dog, 12 teeth (16 teeth to the inch) with 19118, for 120195 and 120196...
120194	8661	Presser Foot for 120196.....
120195	8661	Throat Plate, for 1/2 in. to 3/4 in. gauge, for 120193 and 120196.....
120196	8661	Strip Folder on 18114, for 31-52 Machine for hemming the right hand edge and turning over the left hand edge, for army shirts.....

NUMERICAL LIST OF PARTS

No.	Plate	Name
120341	8680	Tweezers (curved) Attachments and Accessories.....
120346	8680	Oiler (copper plated) with 120347 (Attachments and Accessories).....
120347	8680	Oiler Spout, 8 1/2 long, for 120346 (Attachments and Accessories).....
120367	8681	Hemmer on Shank, for handkerchief work..
120452	8681	" " " 1/32 in. to 1/8 in. gauge, for Windsor ties.....
120479	8212	Quilter Guide (left) for 120485.....
120480	8212	" " (right) for 120485.....
120481	8212	" " Bracket for 120482.....
120482	----	" " " 120481 with 120483 and two 209C, for 120485.....
120483	8212	Quilter Guide Disengaging Sleeve, for 120482.....
120484	8212	Quilter Guide Disengaging Sleeve Spring for 120485.....
120485	----	Quilter complete, Nos. 602D, 120479, 120480 120482 and 120484.....
126036	8678	Driving Attachment Treadle for 126209...
126205	8683	" " " Bracket (left) for 126206.....
126206	----	Driving Attachment Treadle Bracket (left) complete, for 126209, Nos. 23258, 126205, 126207, 126208 and two wood screws 1 in. No. 14.....
126207	8683	Driving Attachment Treadle Bracket (left) Hook for 126206.....
126208	8674	Driving Attachment Treadle Bracket (left) Hook Rivet for 126206.....
126209	----	Driving Attachment Treadle complete for 126213, Nos. 60502, 126036 and 126206
126213	----	Driving Attachment Treadle and Pitman complete for 20141, Nos. 14233 and 126209.....
132590	8645	Arm Oil Tube Packing (wick) for 12454...
150203	20335	Thread Unwinder Spool Rest Cushion (felt) for 225258.....
150208	8685	Driving Attachment Treadle Pitman Rod (lower) Spring for 14233.....
200056E	8676	Bobbin Winder Stop Latch Screw for 225382.....
200082D	8676	Bobbin Winder Tension Bracket Screw for 225382.....
200299H	8676	Bobbin Winder Stop Latch Trip Lever Hinge Screw for 225382.....
200380C	8676	Bobbin Winder Pulley Set Screw for 202473.....

NUMERICAL LIST OF PARTS

No.	Plate	Name
200383C	8671	Thread Unwinder Spool Rest Rod Set Screw for 202490.....
201018C	8671	Thread Unwinder Spool Rest Set Screw for 225257.....
201499B	8686	Bobbin Winder Tension Stud for 225461...
201572B	8676	" " " " Thumb Nut for 225462.....
201696J	8671	Thread Unwinder Thread Guide Lock Nut for 225258.....
202277	8676	Bobbin Winder Frame Oil Packing (wick) for 225453.....
202407	8678	Bobbin Winder Tension Spring for 225462.
202473	8686	" " Pulley with 200380C, for 225382.....
202478	8686	Bobbin Winder Stop Latch Trip Lever for 225382.....
202490	20335	Thread Unwinder Spool Stand with 200383C for 225258.....
225257	20335	Thread Unwinder Spool Rest with 201018C, for 225258.....
225258	20335	Thread Unwinder complete, for two spools or two large cones of thread, Nos. 201696J, 202490, 225257, 225324, 225326, 225388, two each 150203, 225391 and three wood screws 7/8 in. No. 12 ...
225322	8671	Thread Unwinder Thread Guide Rod Washer for 225324.....
225324	20335	Thread Unwinder Thread Guide Rod with 208E and 225322, for 225258.....
225326	20335	Thread Unwinder Thread Guide Position Cup for 225258.....
225381	8686	Bobbin Winder Spindle for 225382.....
225382	8678	Bobbin Winder (swinging automatic, right hand) complete, for 19131, for power table, Nos. 200056E, 200082D, 200299H, 202473, 202478, 225381, 225433, 225444, 225453 to 225456, 225458, 225462, 228026, two each 225459 and wood screws 3/4 in. No. 12 R.H.B.....
225388	20335	Thread Unwinder Spool Rest Rod for 225258.....
225390	8670	Thread Cone Holder for inverted cones, for 225258.....
225391	20335	Thread Unwinder Thread Guide for 225258.
225433	8678	Bobbin Winder and Tension Bracket Base for 225382.....
225438	8676	Bobbin Winder Frame Oil Well Cap for 225453.....

NUMERICAL LIST OF PARTS

No.	Plate	Name
225444	8686	Bobbin Winder Stop Latch for 225382.....
225453	8686	" " Frame with 202277, 225438, for 225382.....
225454	8686	Bobbin Winder Frame Hinge Pin for 225382
225455	8676	" " Spring for 225382...
225456	8676	" " " " Plunger for 225382.....
225458	8686	Bobbin Winder Stop Latch Thumb Lever for 225382.....
225459	8676	Bobbin Winder Stop Latch Thumb Lever Hinge Stud for 225382.....
225459	8678	Bobbin Winder Stop Latch Thumb Lever Joint Stud for 225382.....
225461	8686	Bobbin Winder Tension Bracket with 201499B, for 225462.....
225462	----	Bobbin Winder Tension Bracket complete for 225382, Nos. 201572B, 202407, 225461 and two 2102.....
228026	8676	Bobbin Winder Tension Bracket Screw Washer for 225382.....

Genuine Singer Needles should be used in Singer Machines. These Needles and their Containers are marked with the Company's Trade Mark "SIMANCO." 1

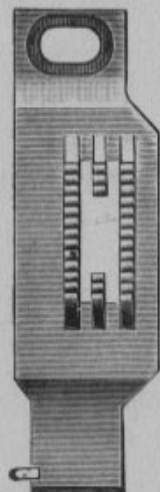
Needles in Containers marked "For Singer Machines" are not Singer made needles. 2

Genuine Singer Needles should be used
in Singer Machines.
These Needles and their Containers
are marked with the
Company's Trade Mark "SIMANCO." 1

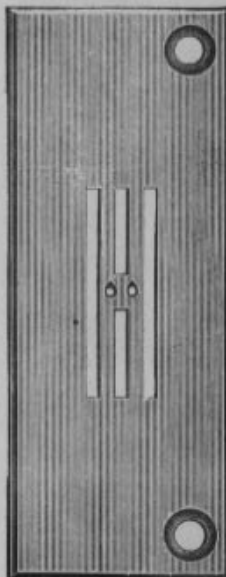
Needles in Containers marked
"For Singer Machines"
are not Singer made needles. 2

PLATE 786—FULL SIZE

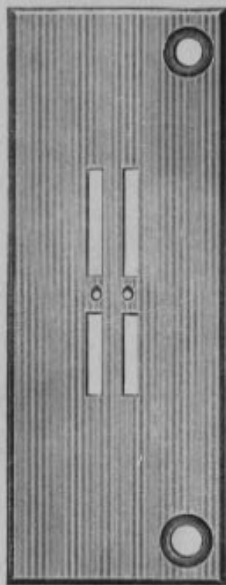
19338



19287



19288



19339

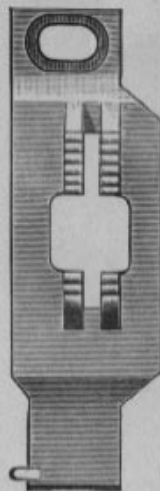
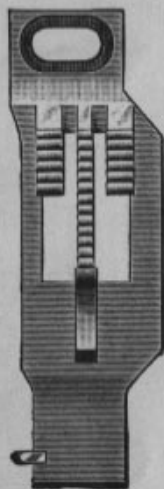
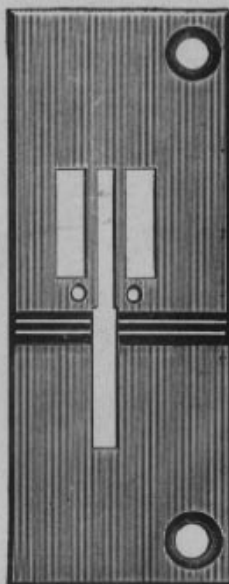


PLATE 788—FULL SIZE

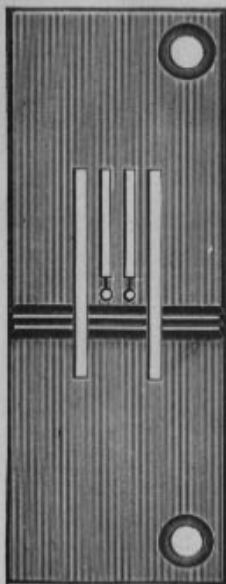
19274



19283



19289



19344

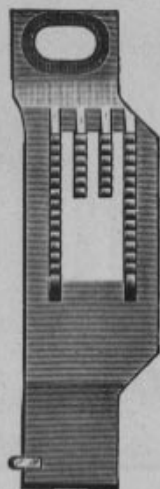
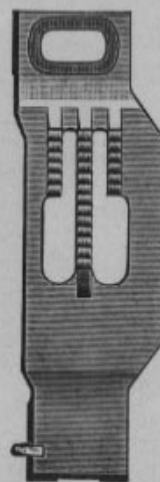
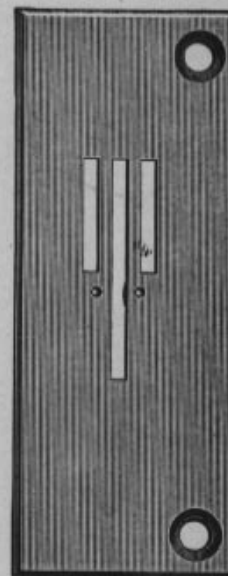


PLATE 789—FULL SIZE

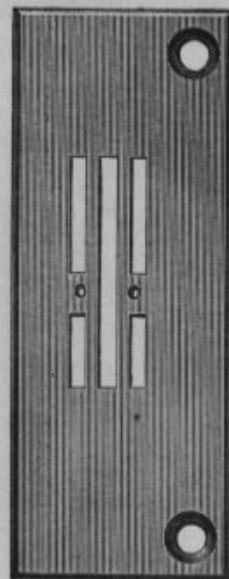
19343



19290



19291



19341

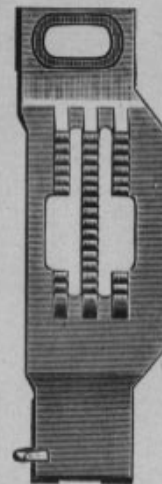


PLATE 797—FULL SIZE

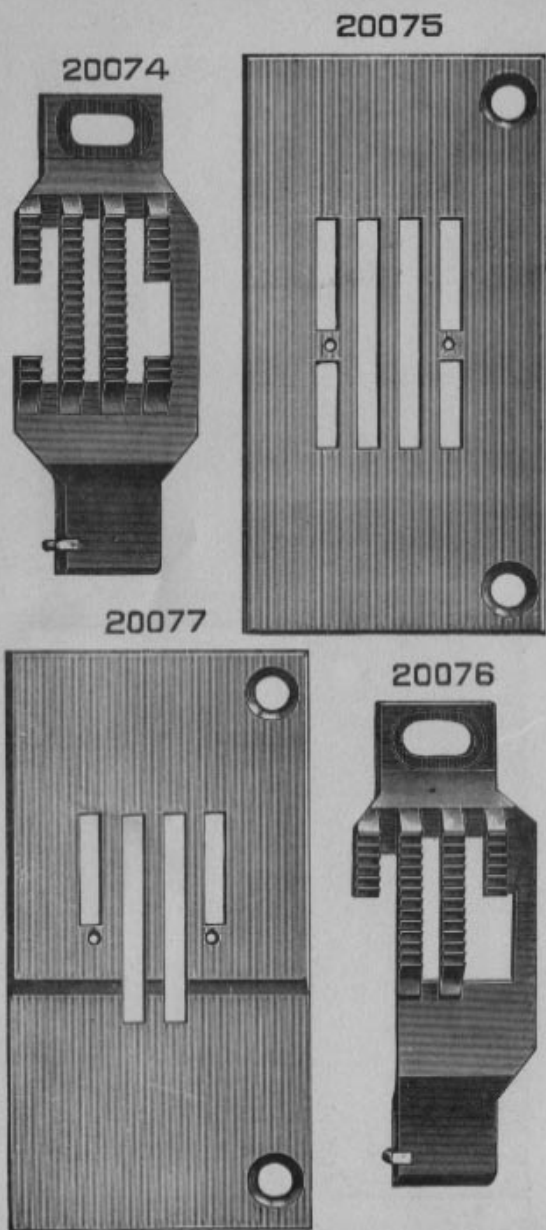


PLATE 799—FULL SIZE

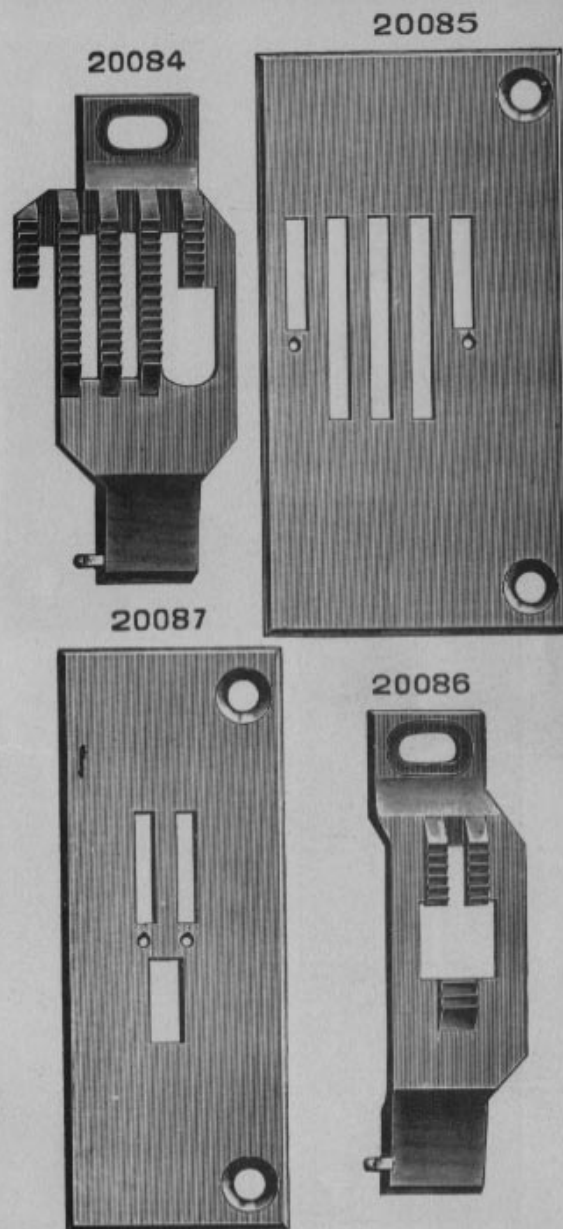


PLATE 800—FULL SIZE

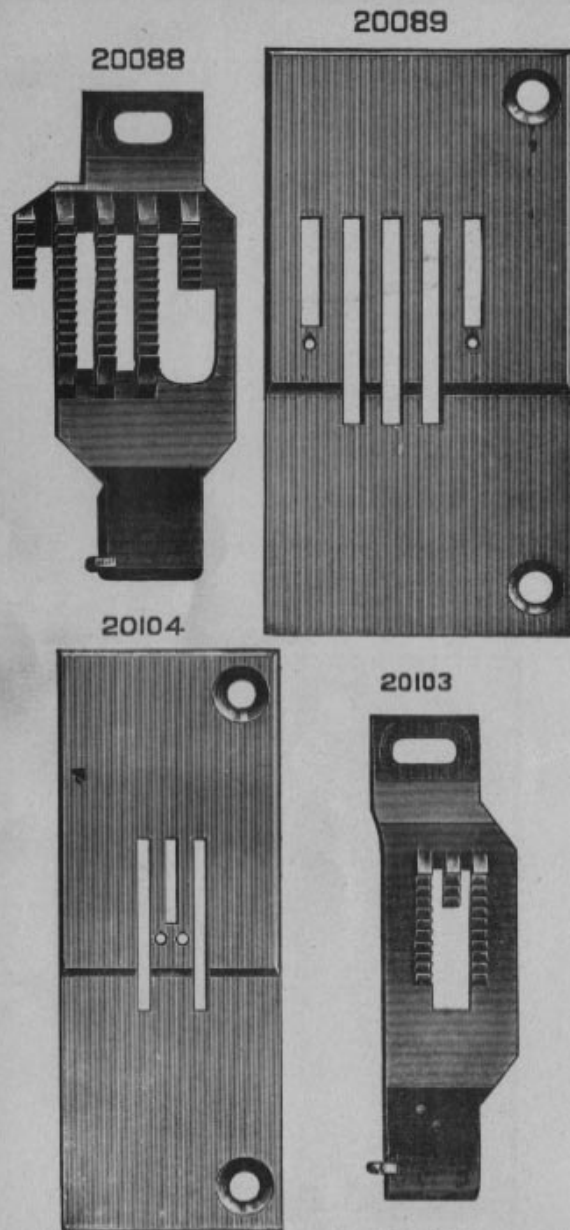


PLATE 819—ONE-FOURTH SIZE

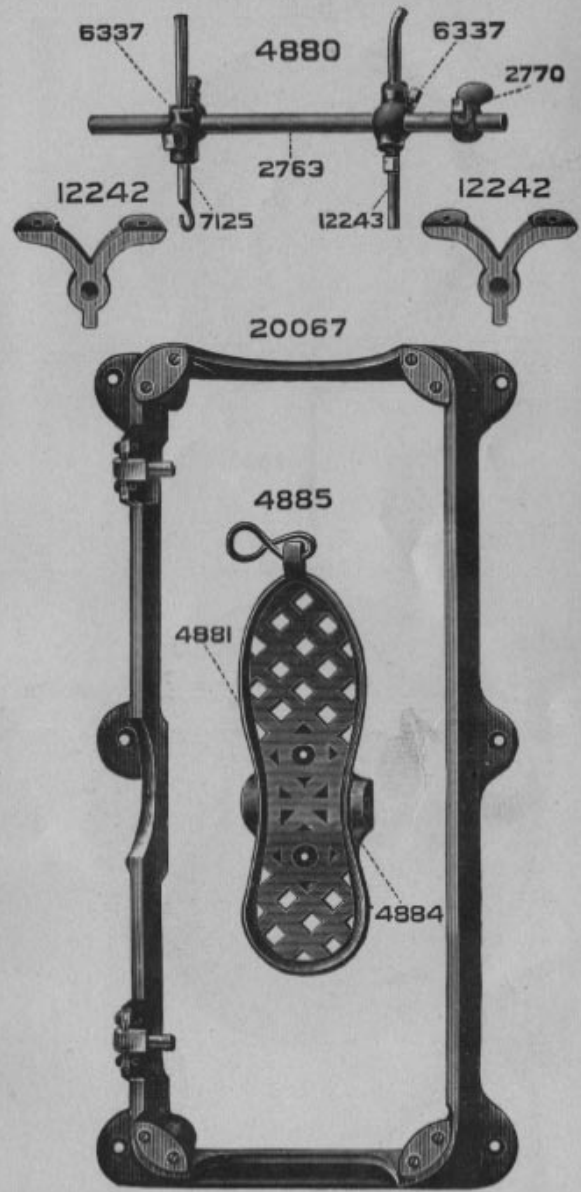
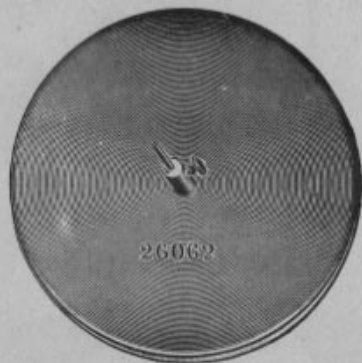


PLATE 989—ONE-FOURTH SIZE

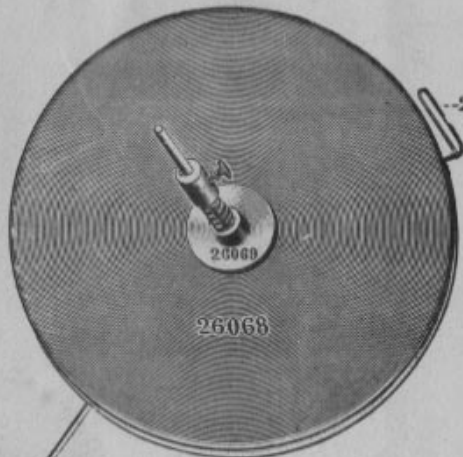
26063



26062

---26061

26074



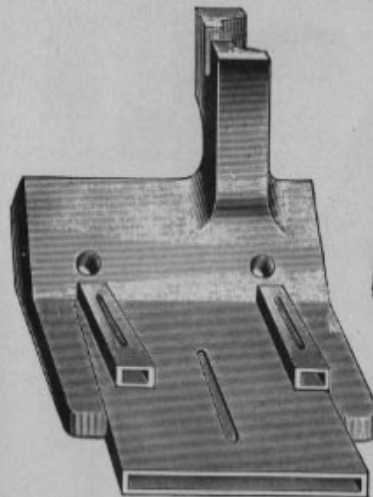
--26072

26068

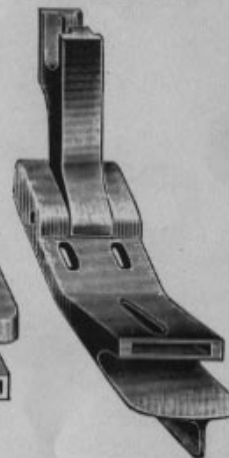
---26066

PLATE 1003—FULL SIZE

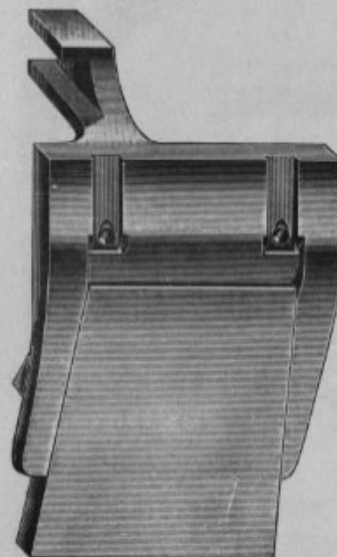
35542



36296



35542



36296

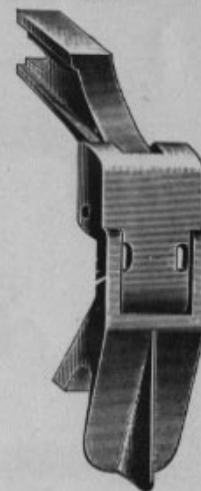


PLATE 1144—FULL SIZE

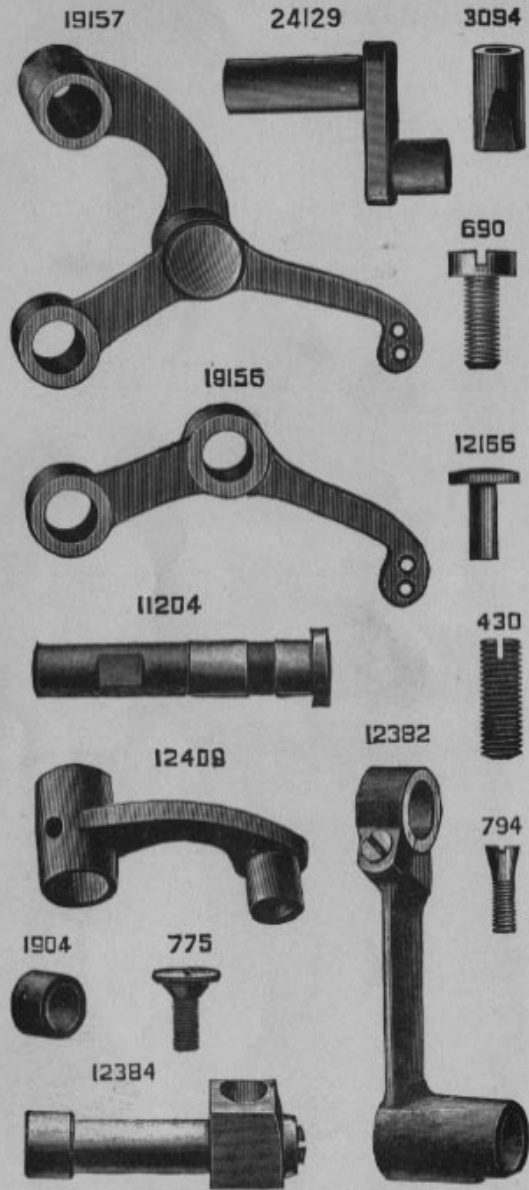
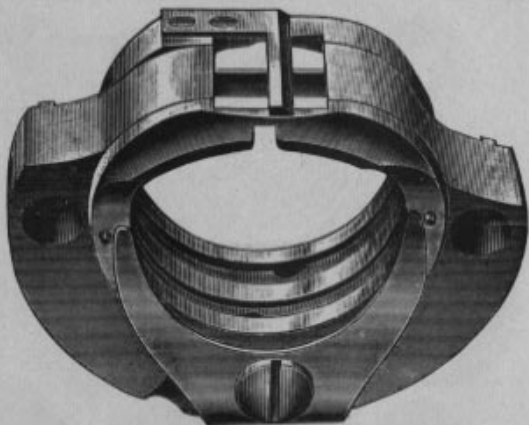


PLATE 1146—FULL SIZE

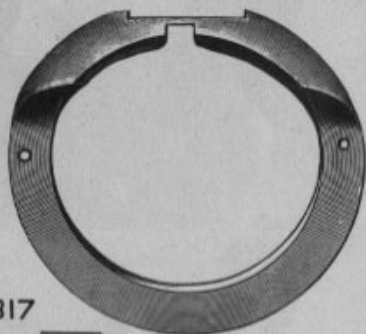


PLATE 1213—FULL SIZE

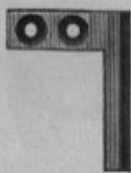
19323



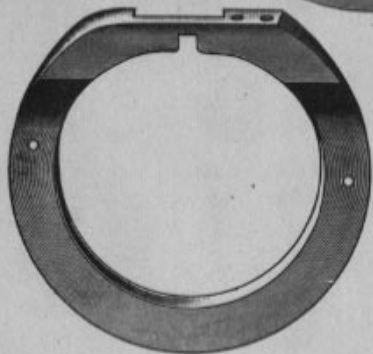
19318



19309



19317



19316

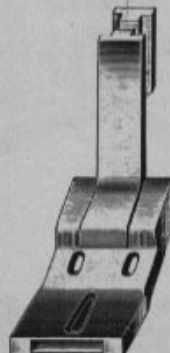


PLATE 1224—FULL SIZE

20050



20049



26408



26410



20052



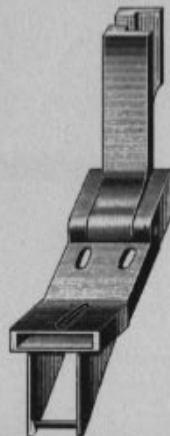
20053



26404



26406

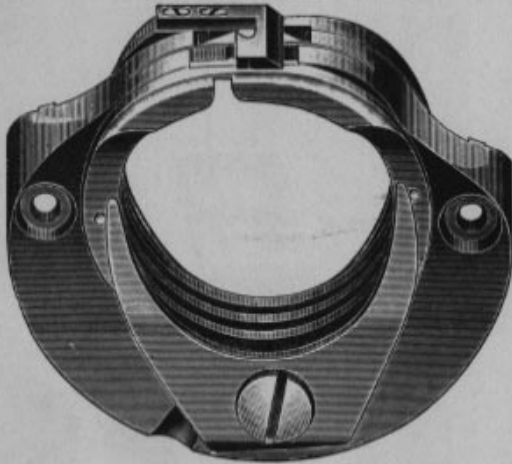


26407



PLATE 1241—FULL SIZE

24493



1053
Y

24492

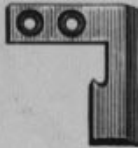


PLATE 1245—FULL SIZE

35560



7308



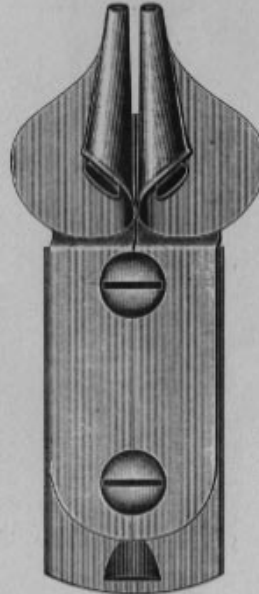
7309



7310



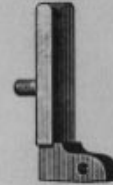
35561



35558



35559



35556



35557



106



220



7311



2532



PLATE 1248—FULL SIZE

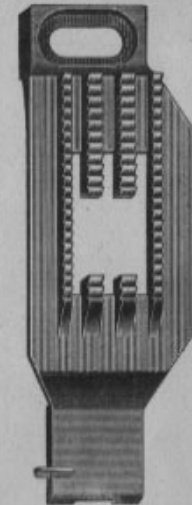
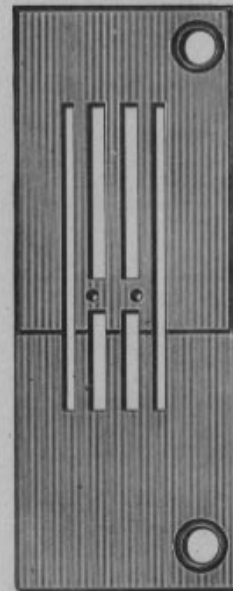
35691



PLATE 1249—FULL SIZE

35695

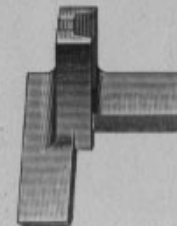
35694



35696

35698

35697



35699

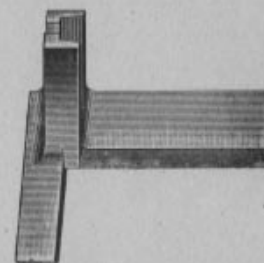
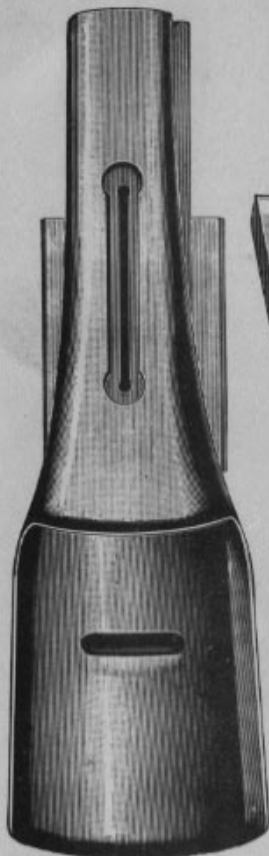
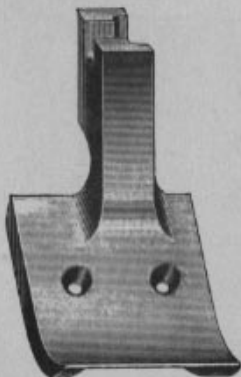


PLATE 1251—FULL SIZE

35702



35703



35703

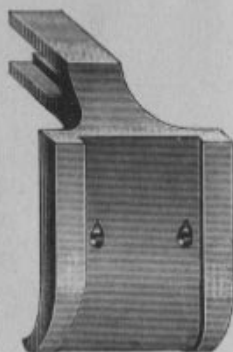
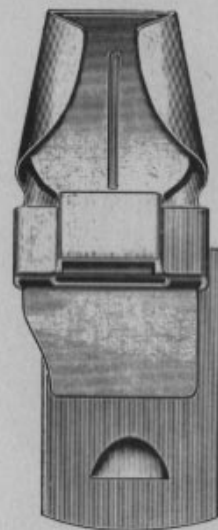
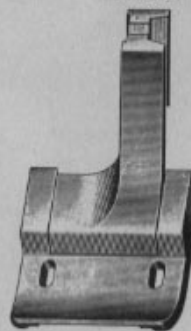


PLATE 1254—FULL SIZE

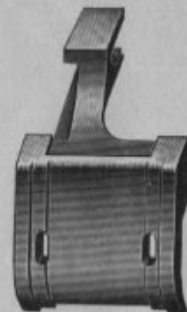
35801



35804



35804



35878

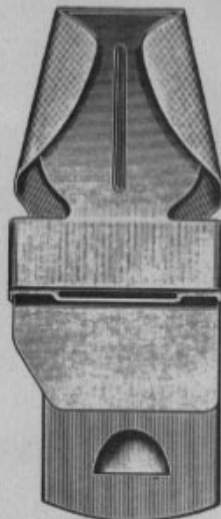
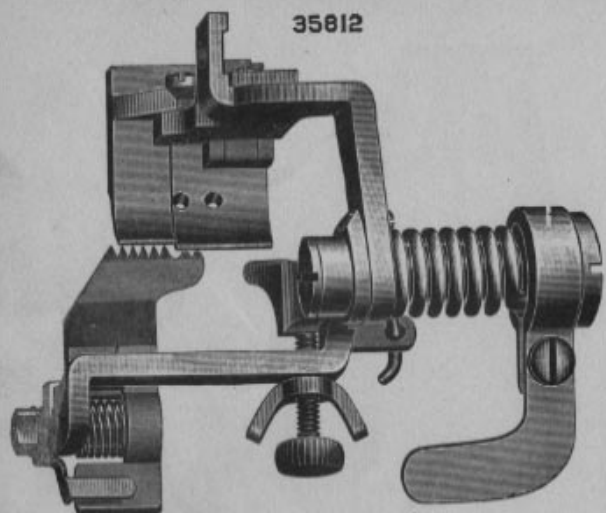


PLATE 1255—FULL SIZE



35809



28597



198



28593

2656



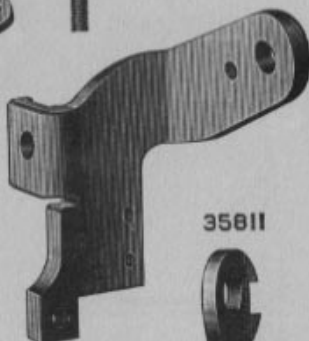
35807



2532



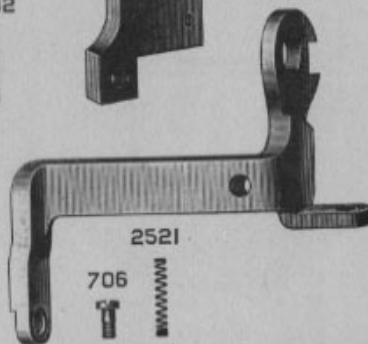
35811



35810



2521



706



PLATE 1256—FULL SIZE

35813

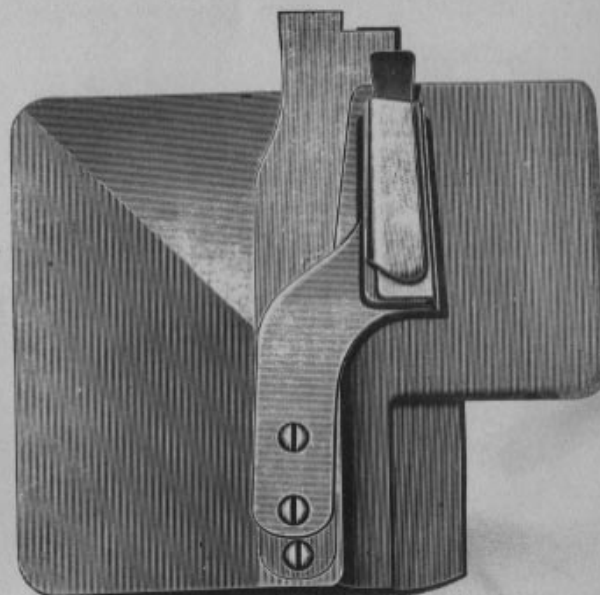
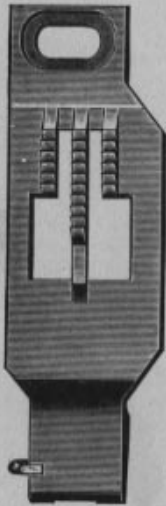


PLATE 1328—FULL SIZE

26725



26726

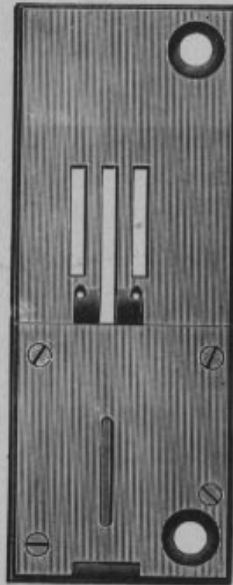
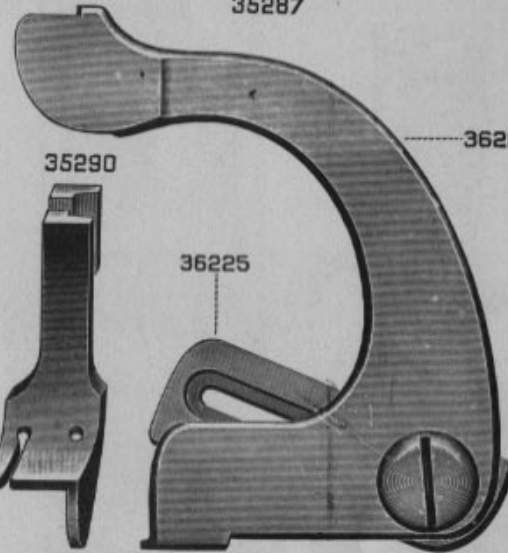


PLATE 2059—FULL SIZE

35287



36224

35290

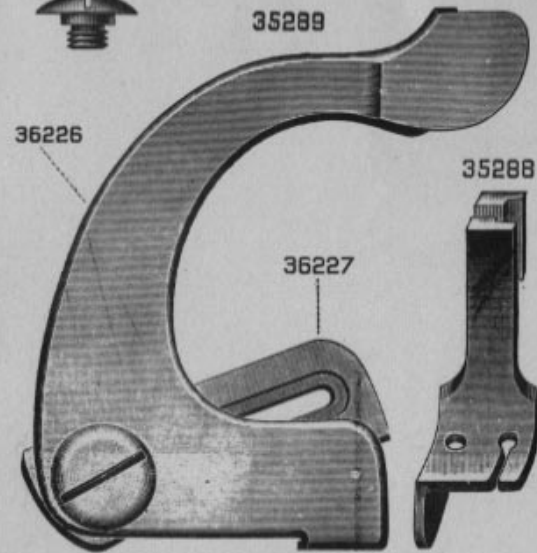


36225



50094

35289



36226

35288

36227



PLATE 2069—FULL SIZE

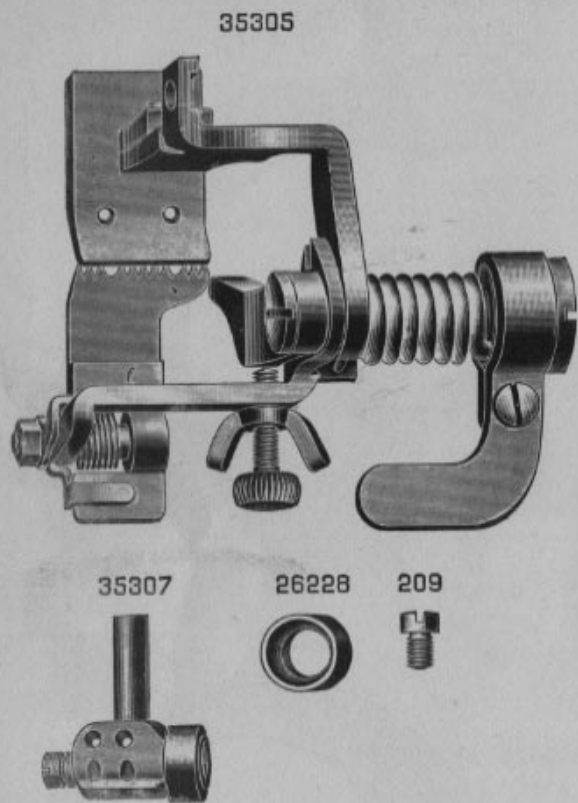


PLATE 2070—FULL SIZE

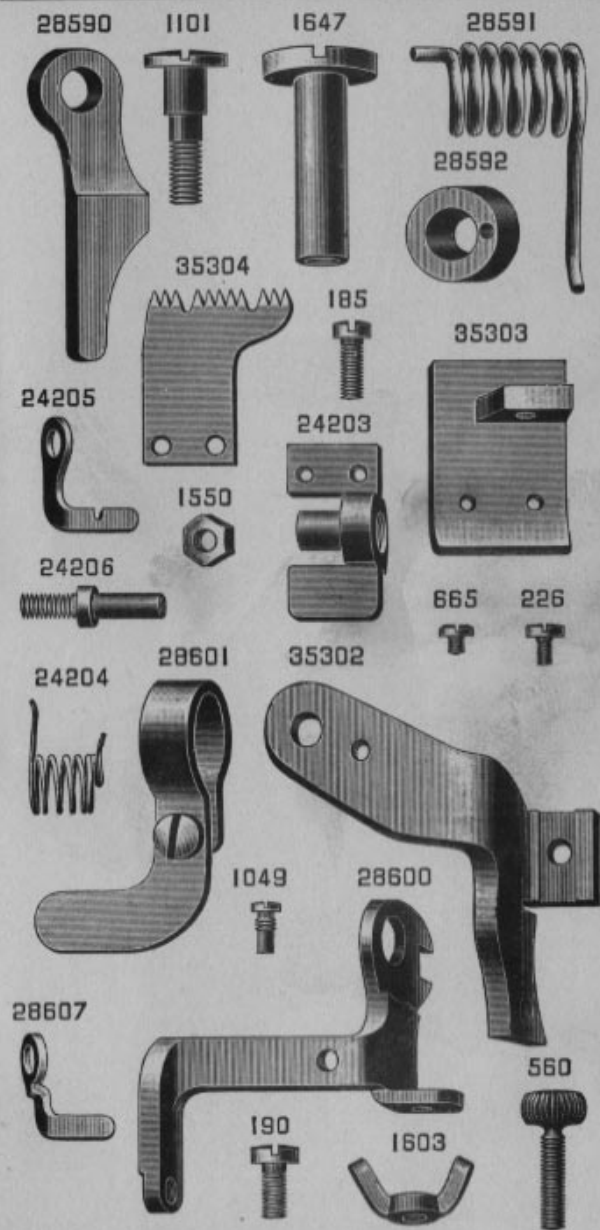


PLATE 2071—FULL SIZE

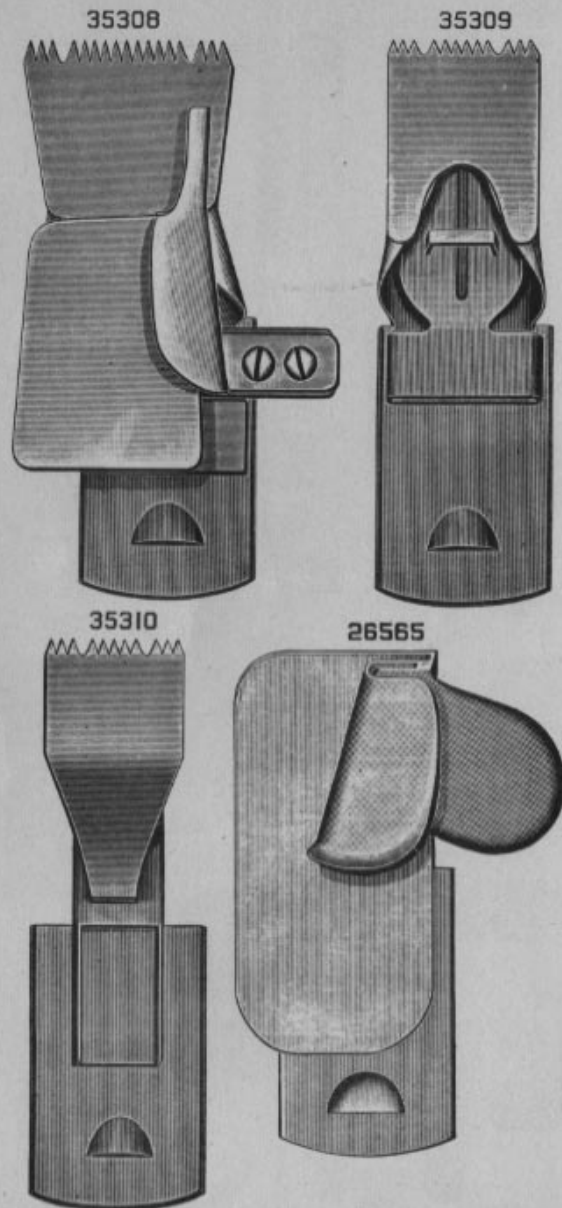


PLATE 2072—FULL SIZE

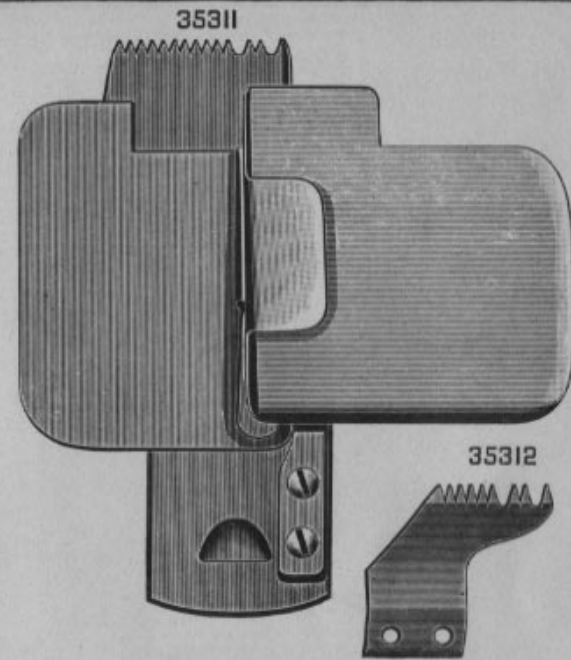
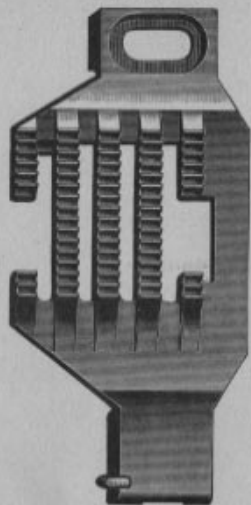


PLATE 2077—FULL SIZE

20279



20280

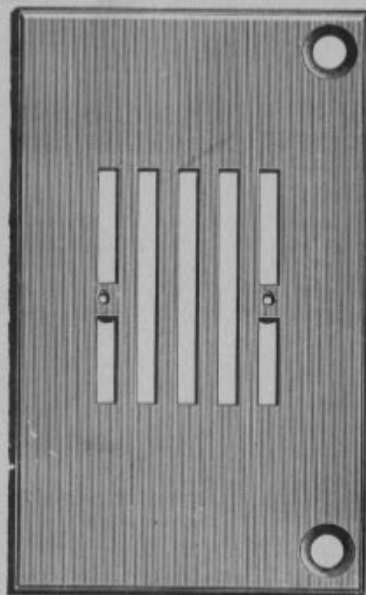
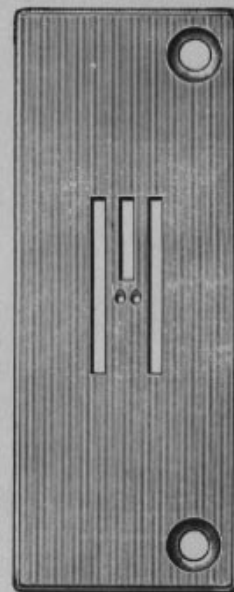


PLATE 2082—FULL SIZE

43964



43965

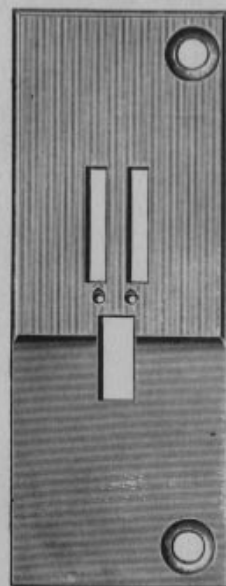
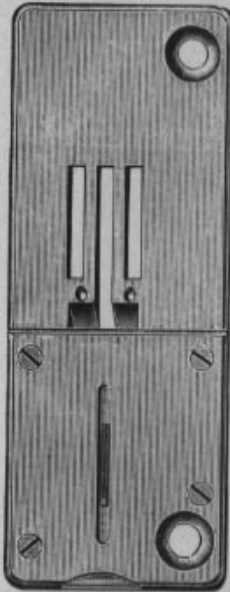


PLATE 2086—FULL SIZE

36310



36311



36313



36312

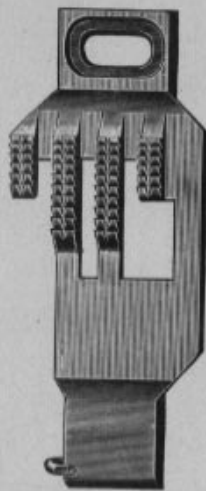
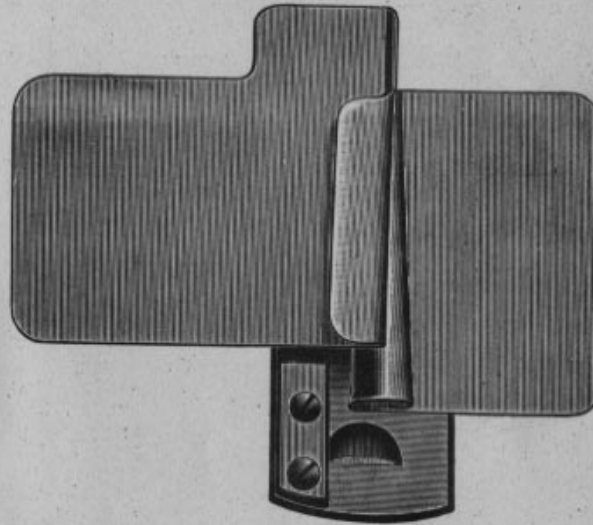


PLATE 2660—FULL SIZE

28934



26965

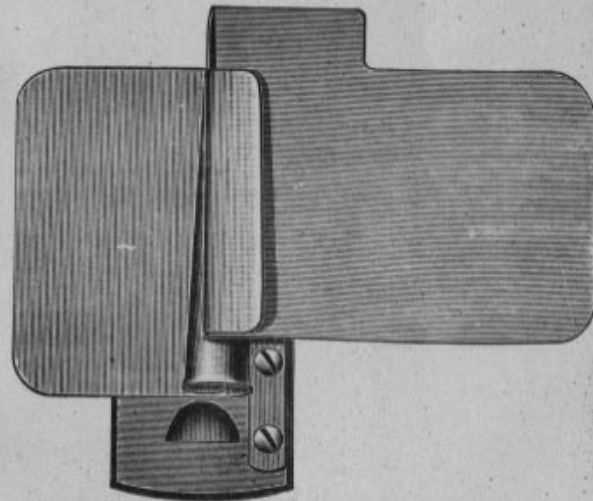


PLATE 2662—FULL SIZE

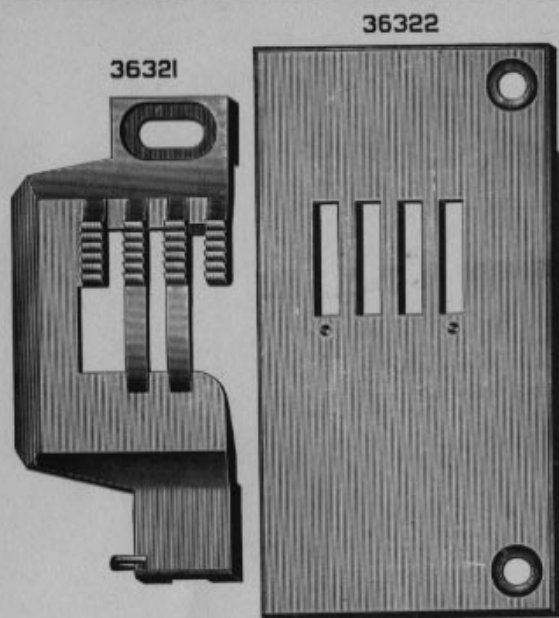


PLATE 2663—FULL SIZE

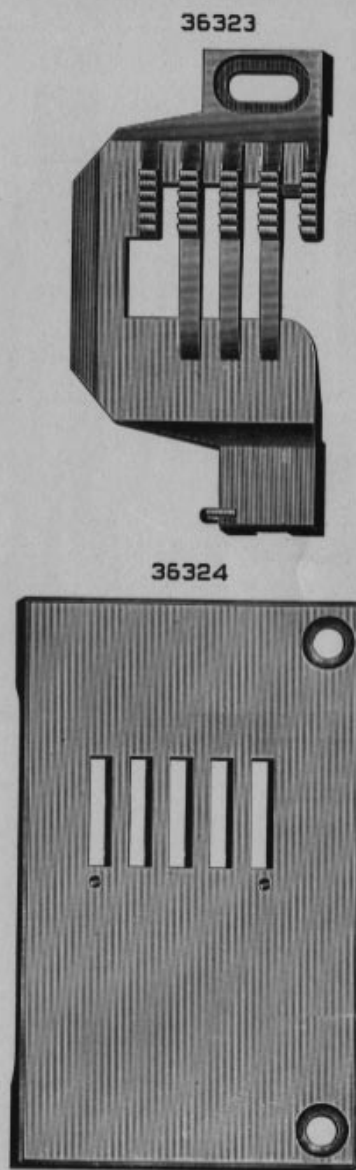


PLATE 2670—FULL SIZE

28995



35071

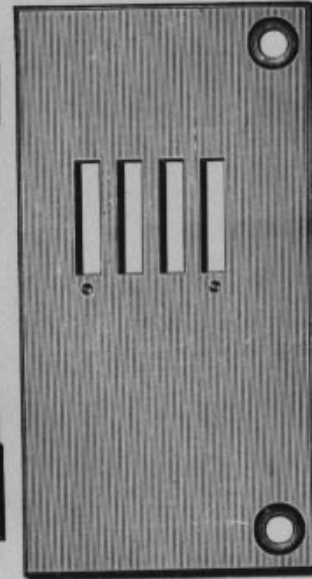


35111



PLATE 2662—FULL SIZE

36322



36321

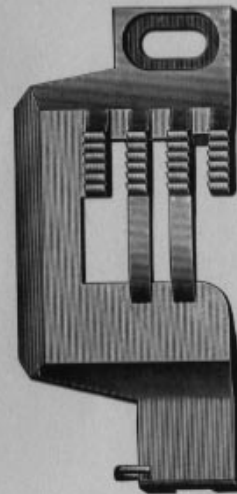
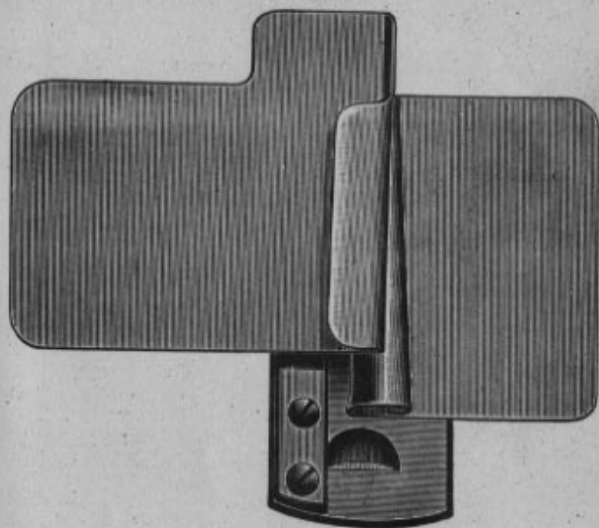


PLATE 2660—FULL SIZE

28934



26965

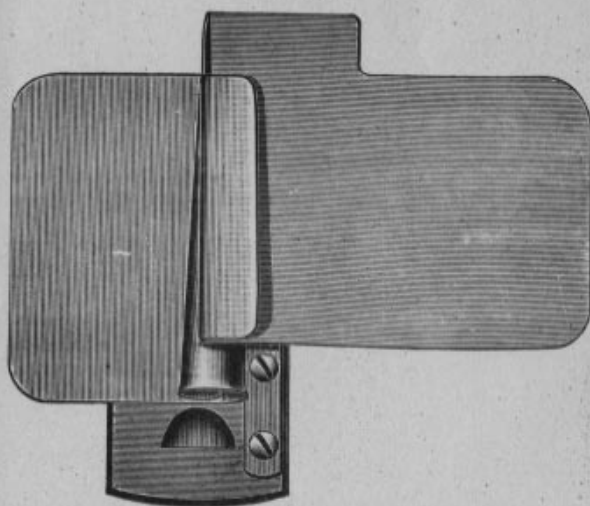
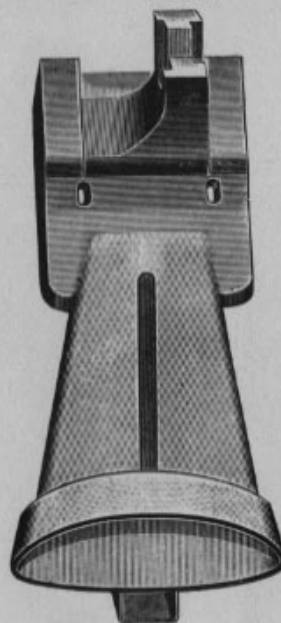


PLATE 2679—FULL SIZE

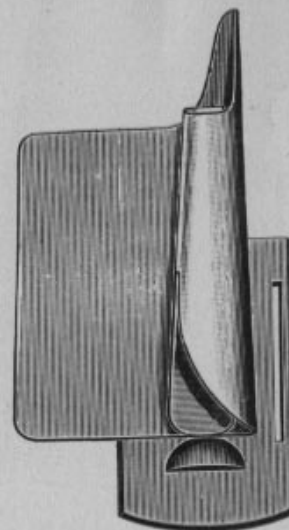
35081



35259



35080

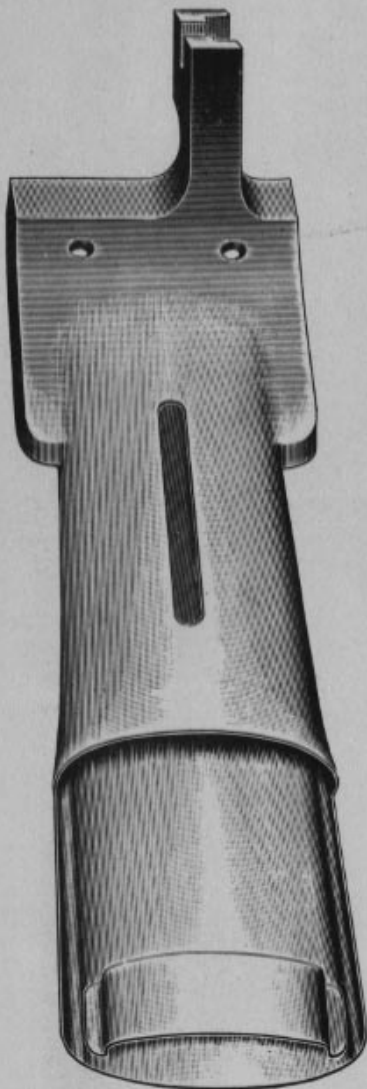


26519

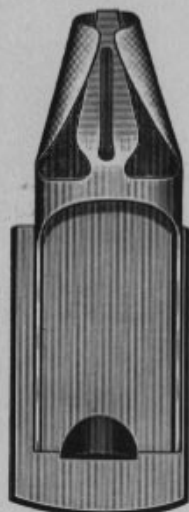


PLATE 2681—FULL SIZE

35083



35102

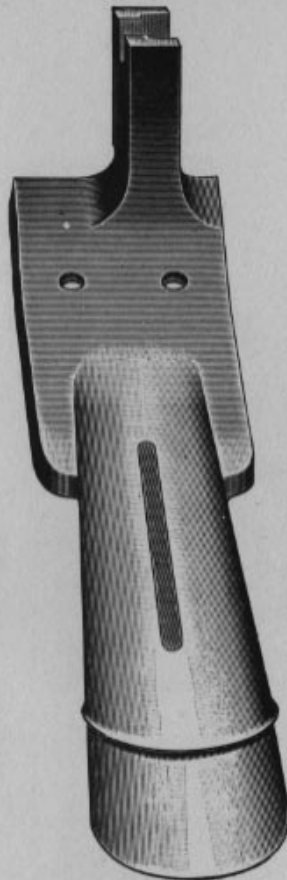


35103



PLATE 2686—FULL SIZE

35133



35133

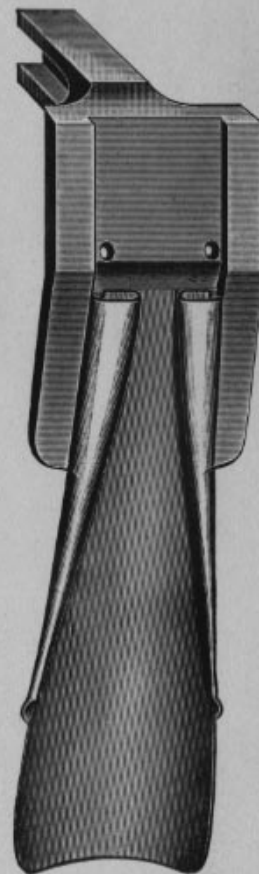
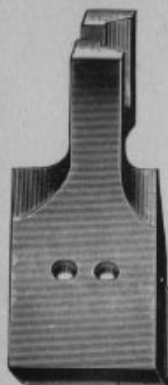


PLATE 5646—FULL SIZE

35194



26887



35194



26887

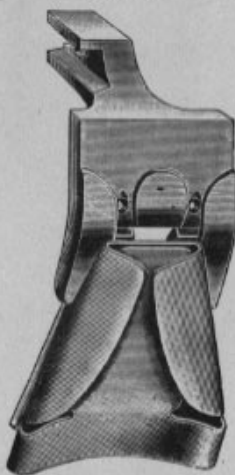


PLATE 5772—FULL SIZE

199



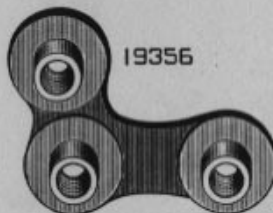
19357



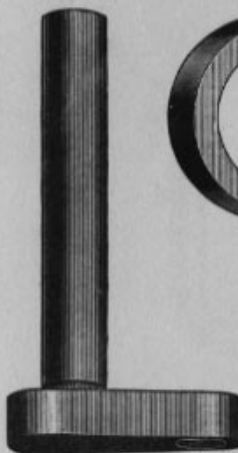
19358



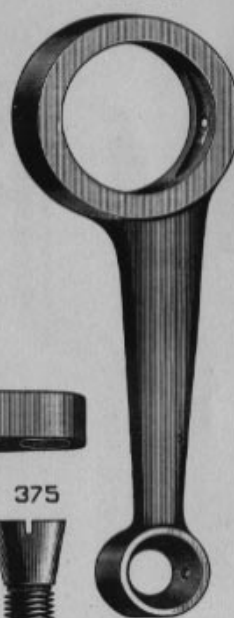
19356



19359



19362



2049



4855



1518



375



PLATE 5773—FULL SIZE

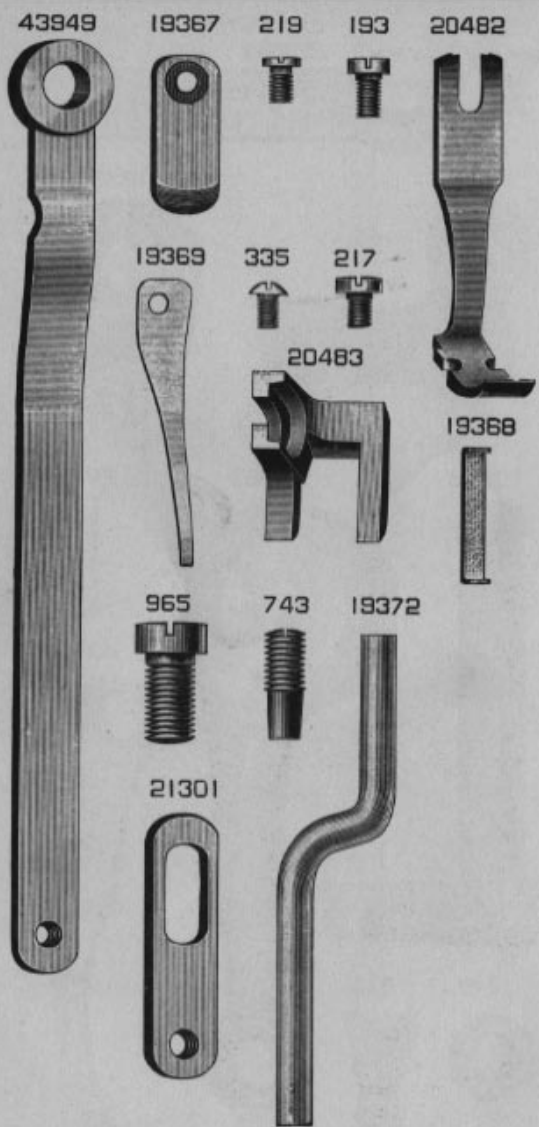


PLATE 5794—FULL SIZE

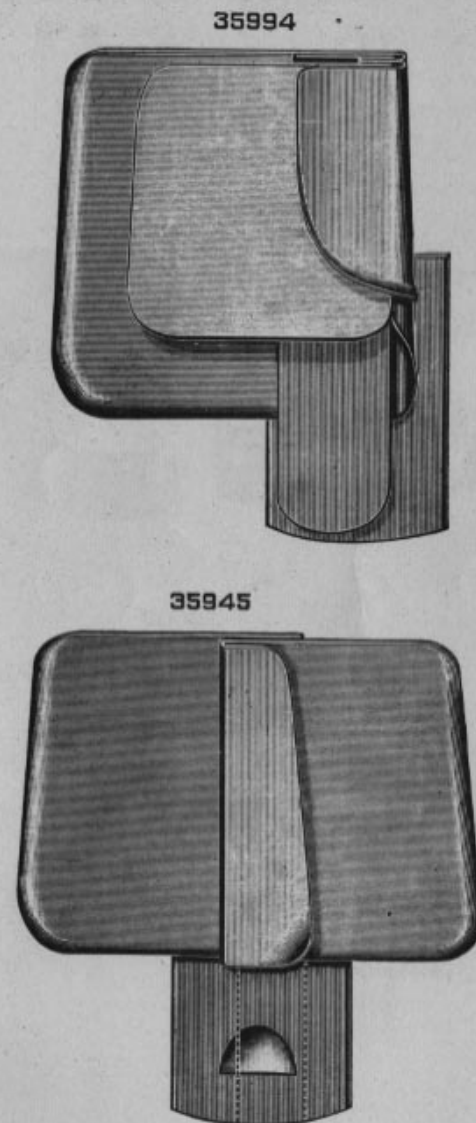
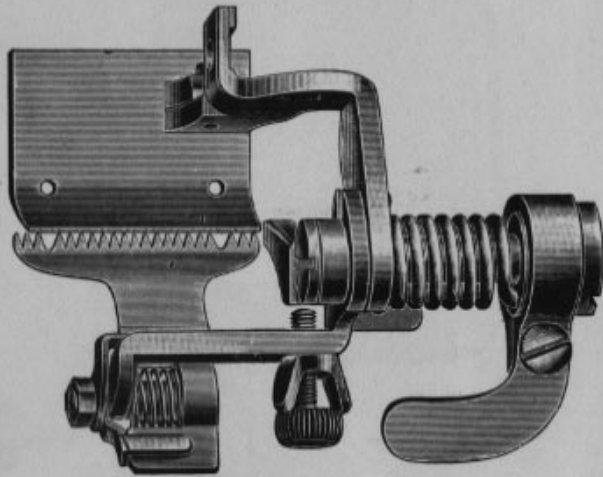
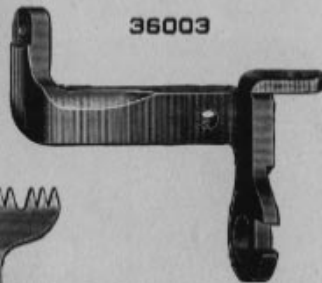


PLATE 5795—FULL SIZE

36004



36003



36002

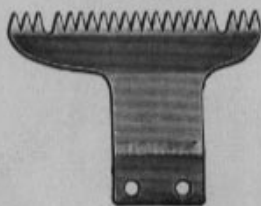
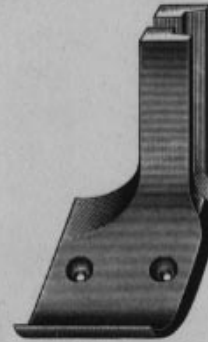


PLATE 5796—FULL SIZE

36078



36078

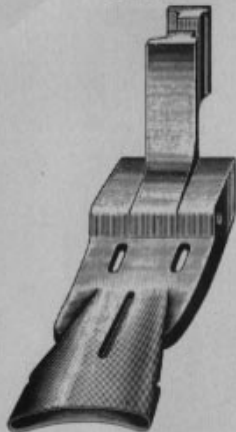


36077

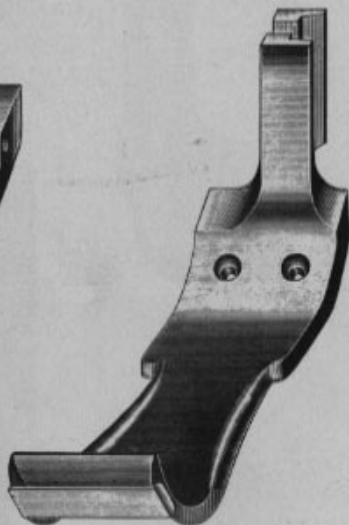


PLATE 5797—FULL SIZE

35887



36089



35887

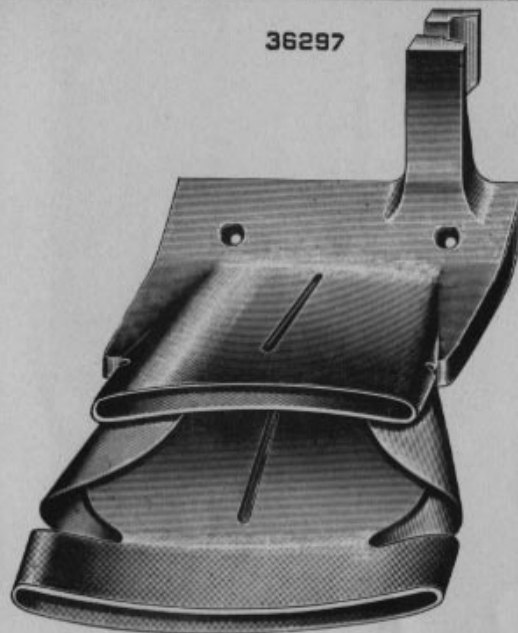


36089



PLATE 5798—FULL SIZE

36297



36297

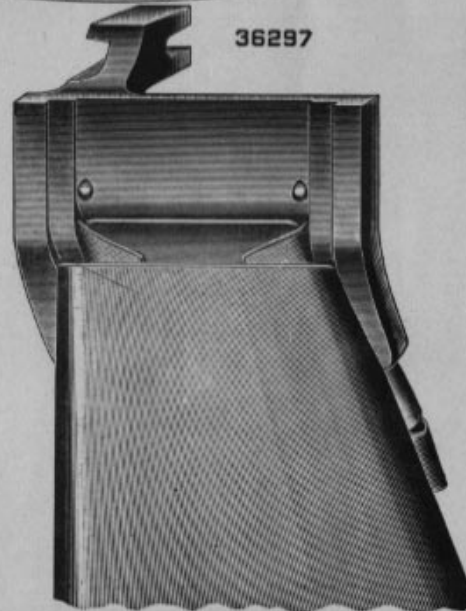
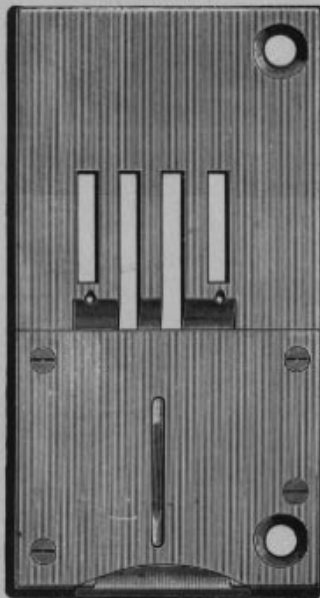


PLATE 5800—FULL SIZE

36314



36315

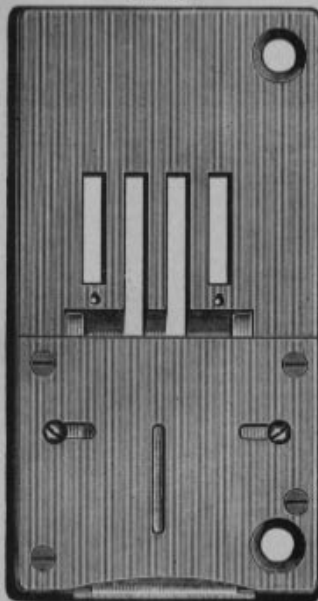
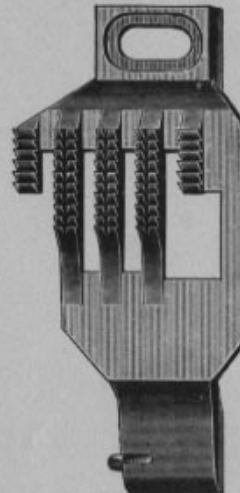


PLATE 5802—FULL SIZE

36317



36318

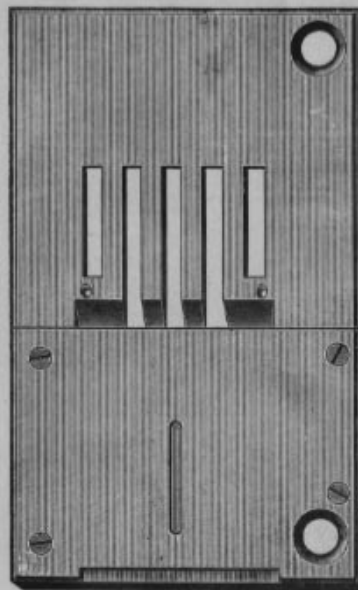


PLATE 8212—FULL SIZE

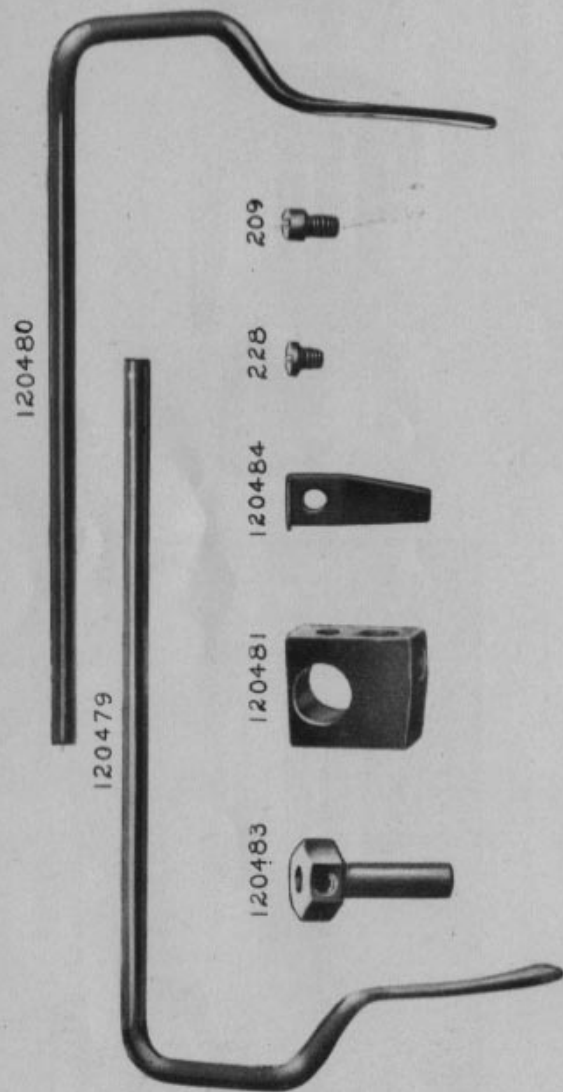


PLATE 8645—FULL SIZE



PLATE 8646-FULL SIZE

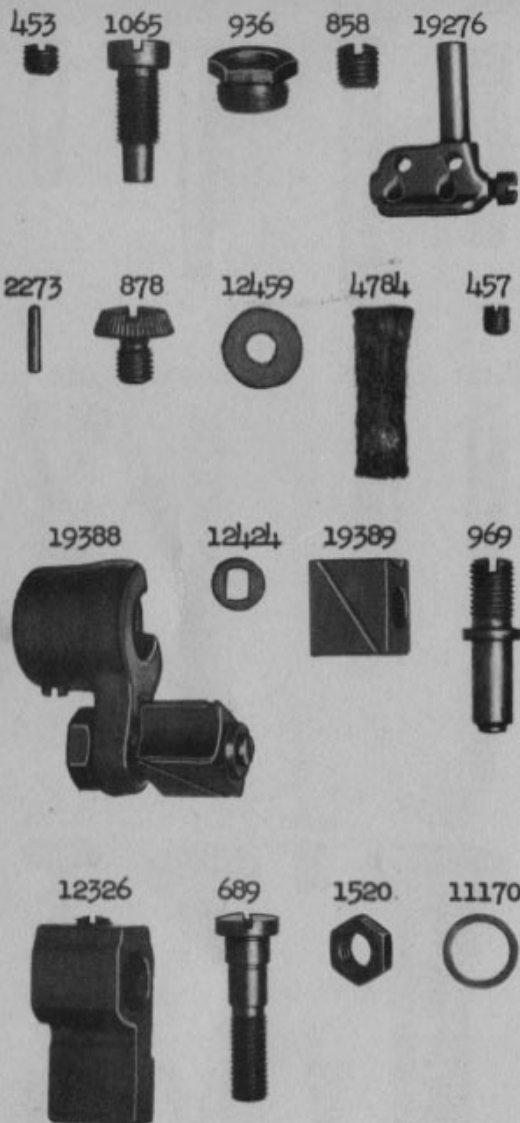


PLATE 8647-FULL SIZE

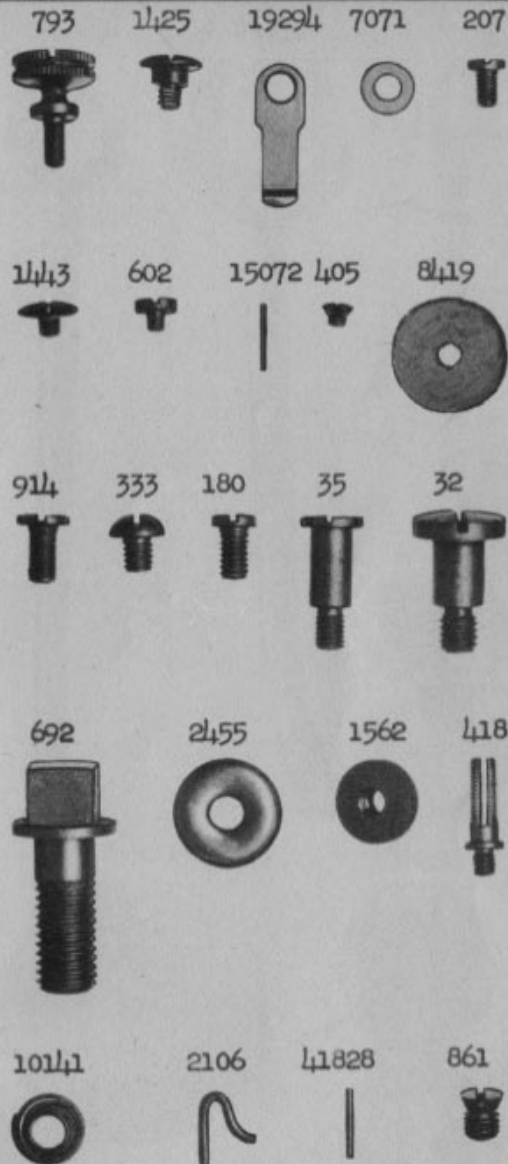
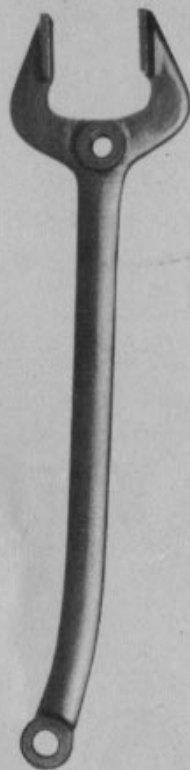


PLATE 8648-ONE-HALF SIZE

20197



12429



43976



15063



2415

12193

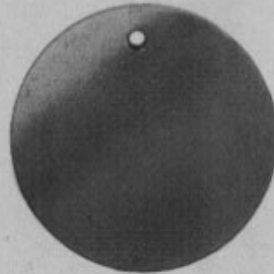


PLATE 8649-ONE-HALF SIZE

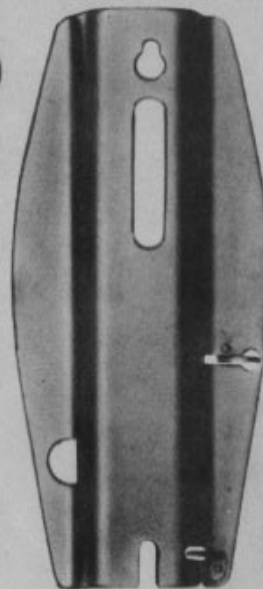
12357



3039



19305



19120



19275



19386



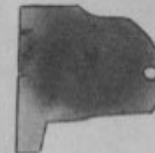
20188



12388



12480



43944



19111

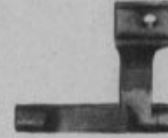


PLATE 8650-FULL SIZE

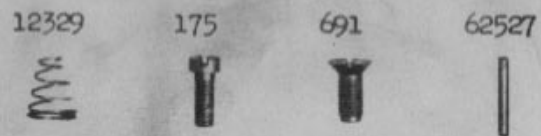
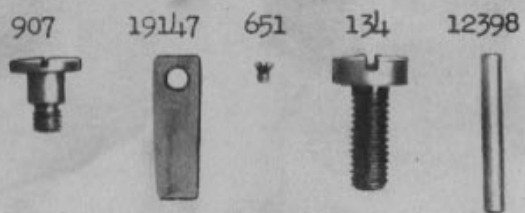
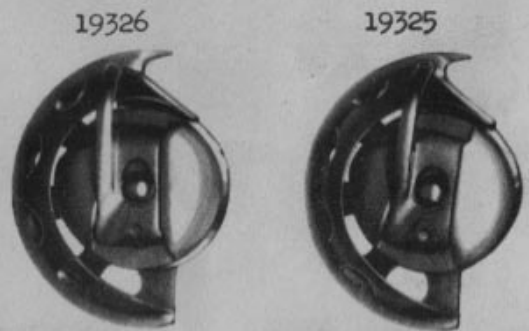
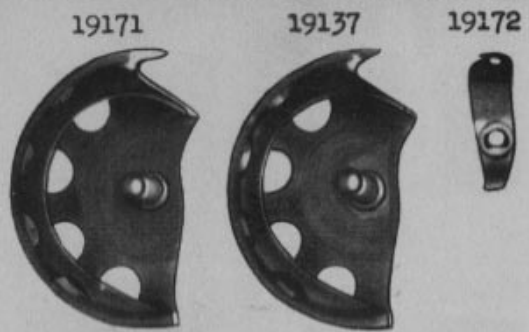


PLATE 8651-FULL SIZE

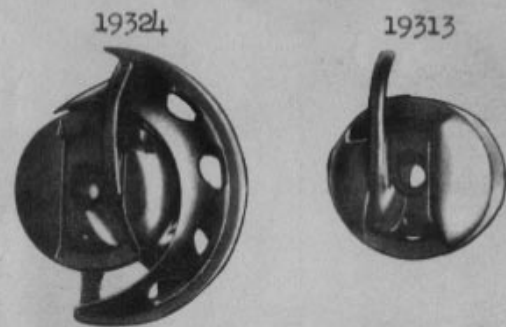
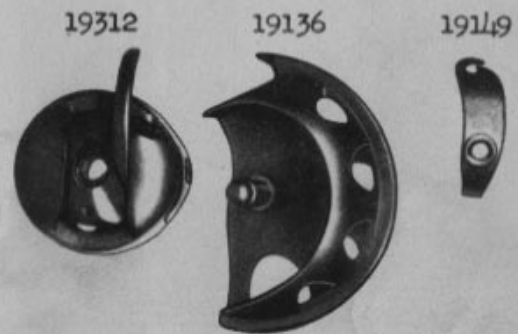
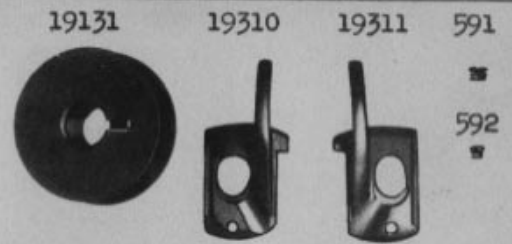
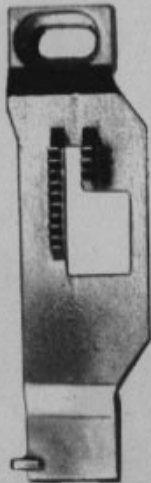


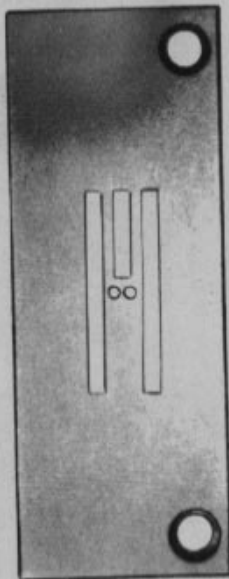
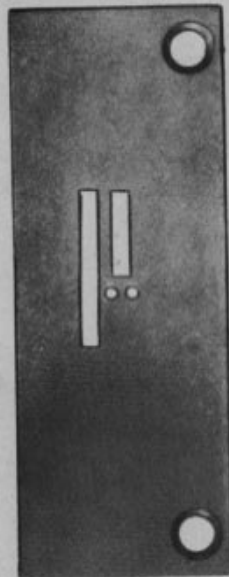
PLATE 8652-FULL SIZE

20375

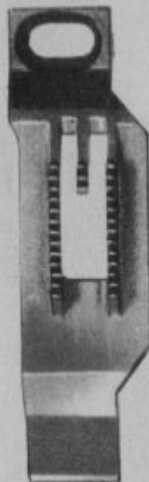
20373



16 Teeth=1 Inch
20384



20383

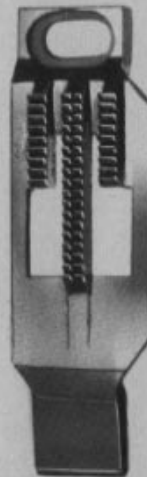


16 Teeth=1 Inch

PLATE 8653-FULL SIZE

20069

20068

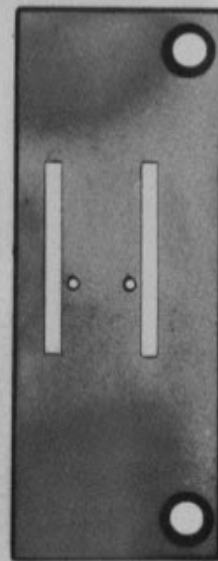


16 Teeth=1 Inch

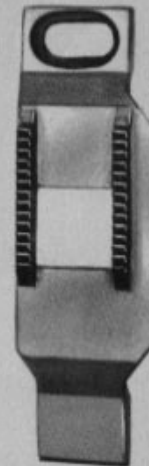
191



20073



20072

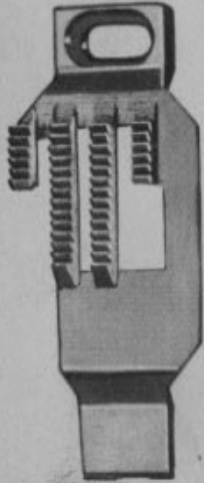


16 Teeth=1 Inch

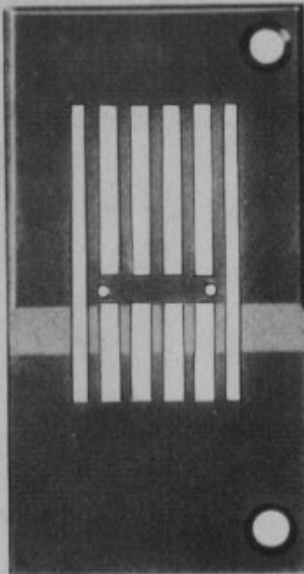
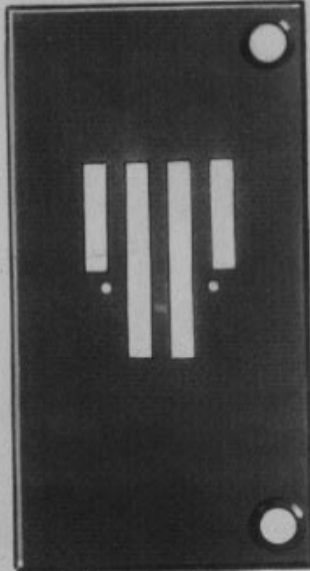
PLATE 8654-FULL SIZE

20079

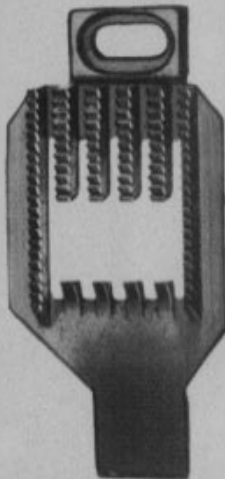
20316



16 Teeth=1 Inch
36496



36494

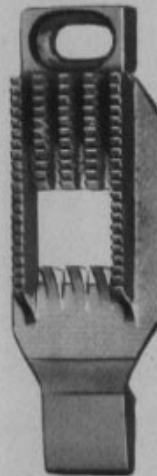


16 Teeth=1 Inch

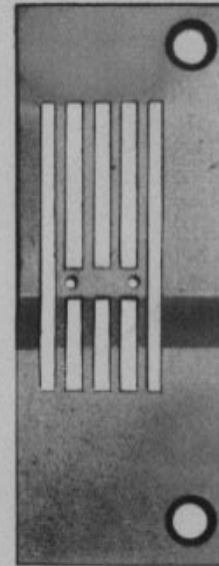
PLATE 8655-FULL SIZE

36607

36606



16 Teeth=1 Inch



36495



36497

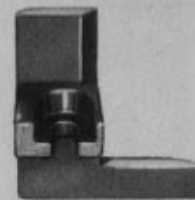
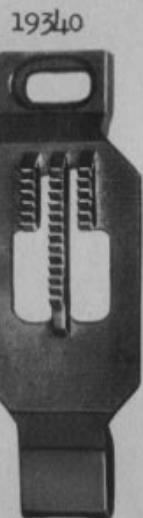
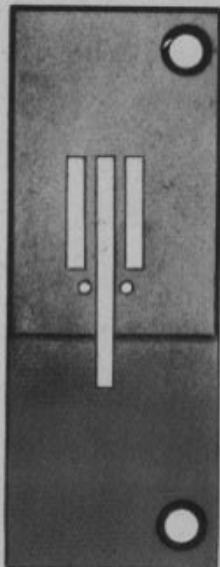


PLATE 8656-FULL SIZE

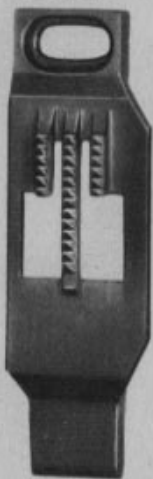
19190



16 Teeth=1 Inch

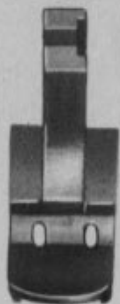


24462



16 Teeth=1 Inch

26383



35196

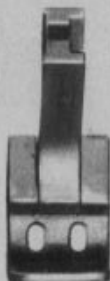
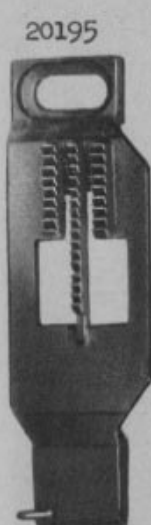


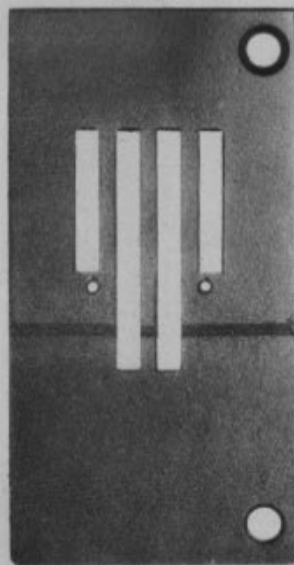
PLATE 8657-FULL SIZE

20196

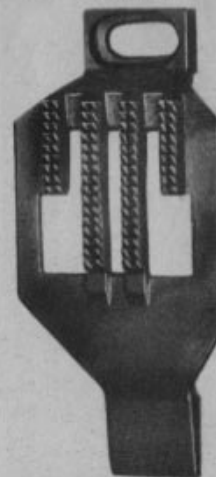


16 Teeth=1 Inch

20388



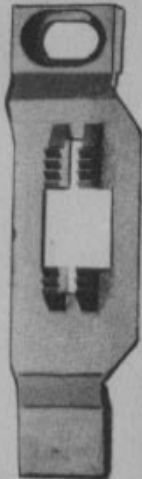
20387



16 Teeth=1 Inch

PLATE 8658-FULL SIZE

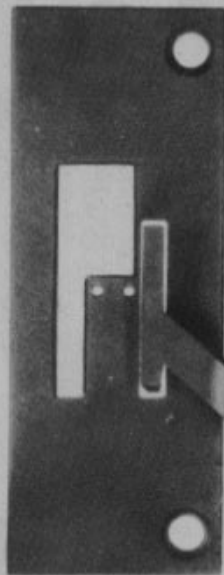
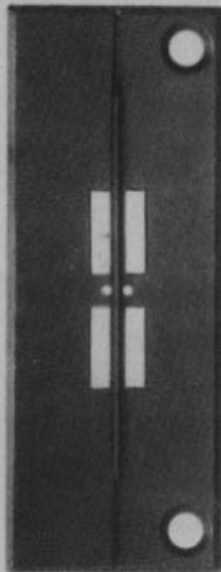
19479



16 Teeth=1 Inch

24450

19481



16 Teeth=1 Inch

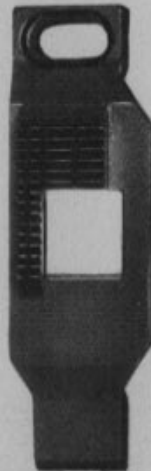
24449



PLATE 8659-FULL SIZE

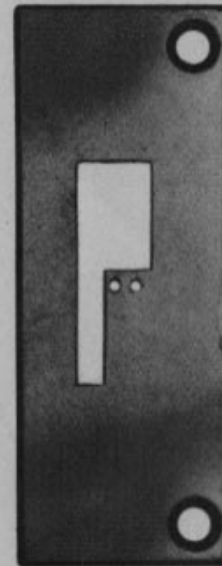
20081

20294



16 Teeth=1 Inch

19484



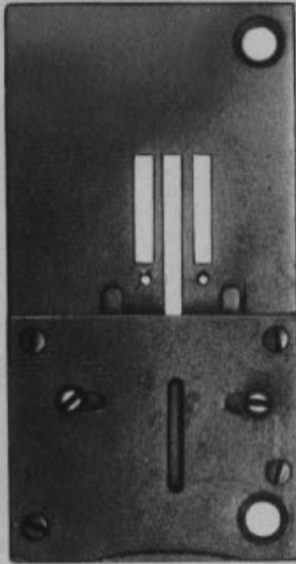
16 Teeth=1 Inch

19482



PLATE 8660-FULL SIZE

36543



36316

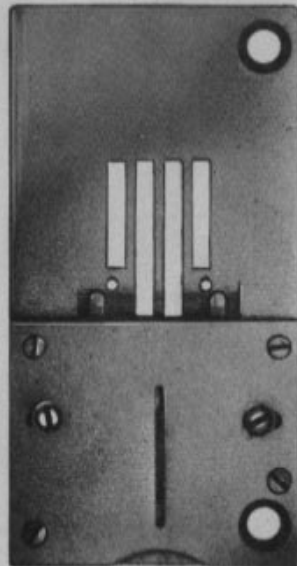
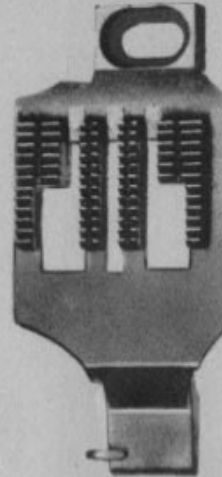


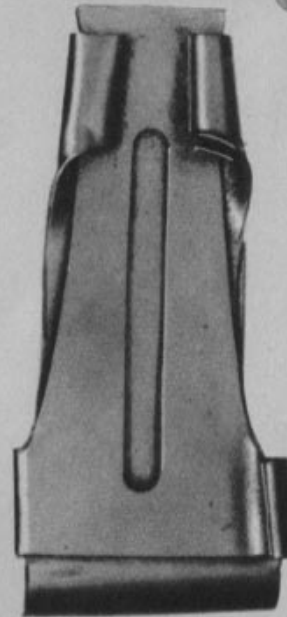
PLATE 8661-FULL SIZE

120193

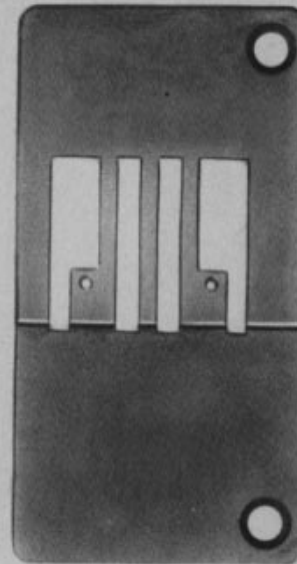


16 Teeth=1 Inch

120196



120195



120194

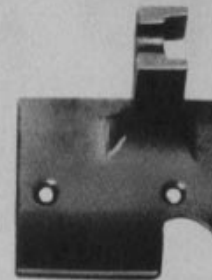
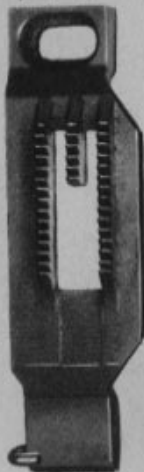


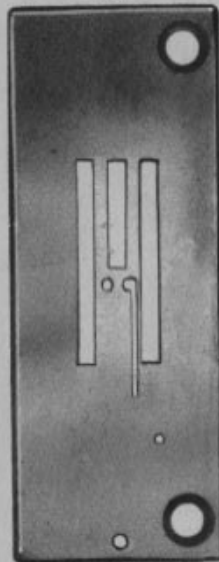
PLATE 8662-FULL SIZE

20317



16 Teeth=1 Inch

20318



26489



26488



26487



6267



25888



102



2653

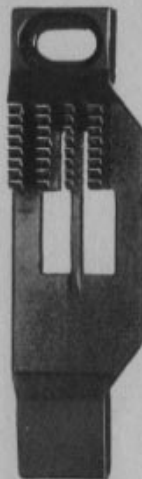


240



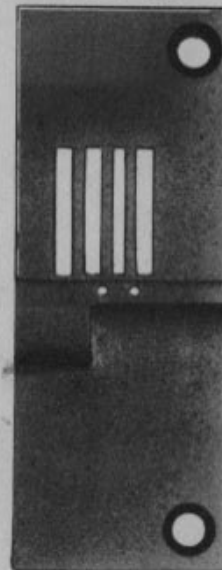
PLATE 8663-FULL SIZE

35814

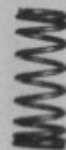


16 Teeth=1 Inch

35815



13211



736



35925



50053



55



26073

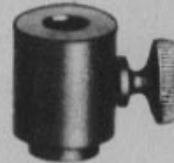
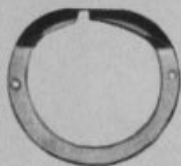


PLATE 8664-ONE-HALF SIZE

19139



19381



2533



29633



24013



12391



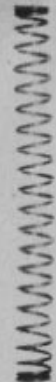
18014



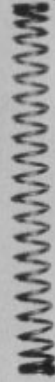
12139



11167



20023



3043



52016



PLATE 8665-FULL SIZE

19128



20374



19480



19483



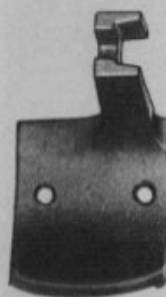
20171



20046



20302



120157

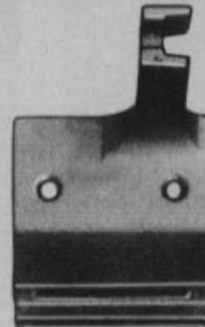
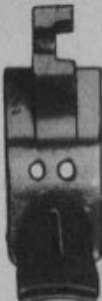


PLATE 8666-FULL SIZE

26411



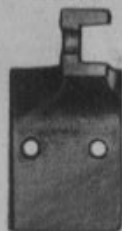
28802



26416



26574



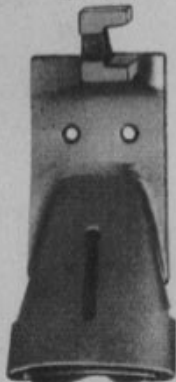
26415



26418



26414



35362

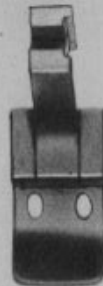


35835



PLATE 8667-FULL SIZE

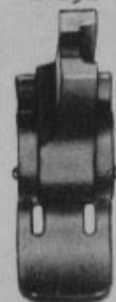
20045



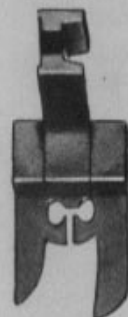
26276



20131



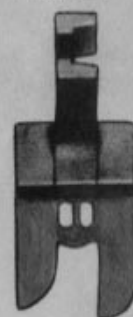
20170



18055



44187



43895



26231



43975



PLATE 8668-FULL SIZE

19216



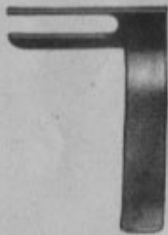
26279



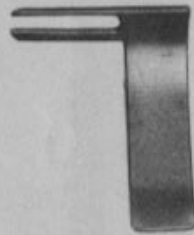
26280



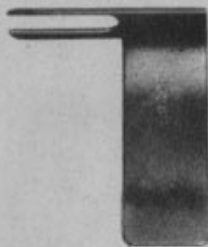
26281



26282



26283



25967



PLATE 8669-ONE-HALF SIZE

19360



19365



24589



24590



27538



26325



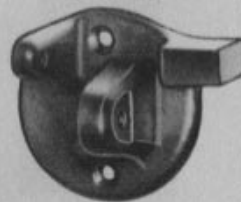
27302



26064



27540



27541

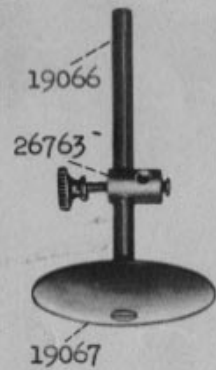


PLATE 8670-ONE-HALF SIZE

20395



26764



27739



225390

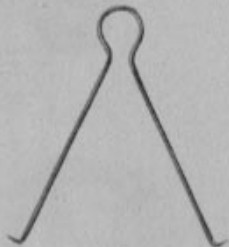
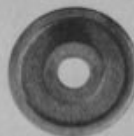


PLATE 8671-FULL SIZE

19159



19161



19160



905



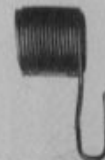
435



7336



19158



766



356



200383



201018



201696



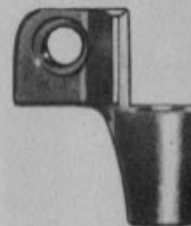
225322



208



12327



12149



12241



PLATE 8672-FULL SIZE

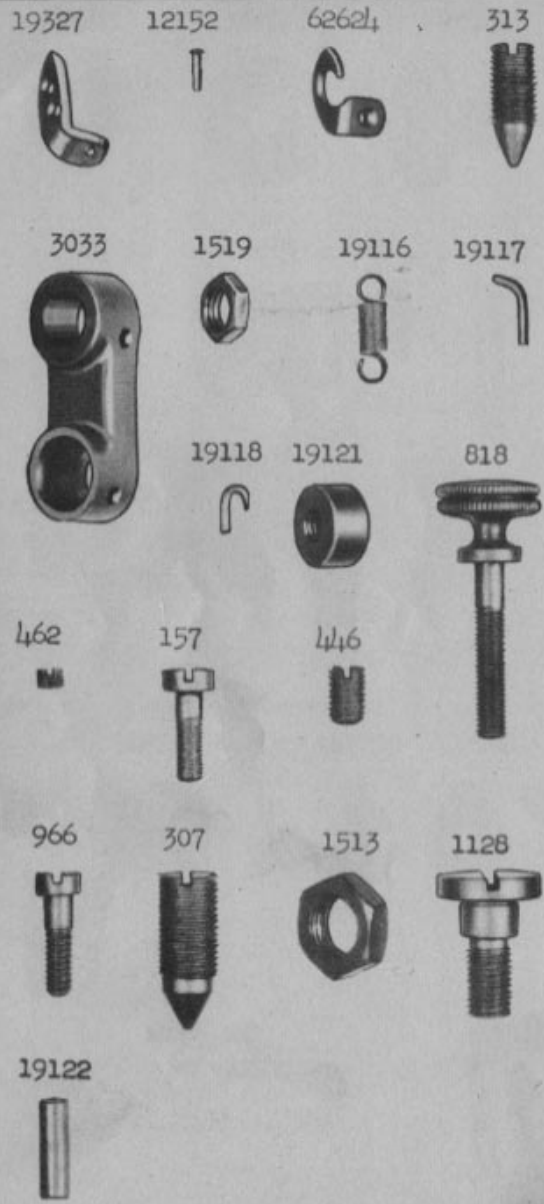


PLATE 8673-ONE-HALF SIZE

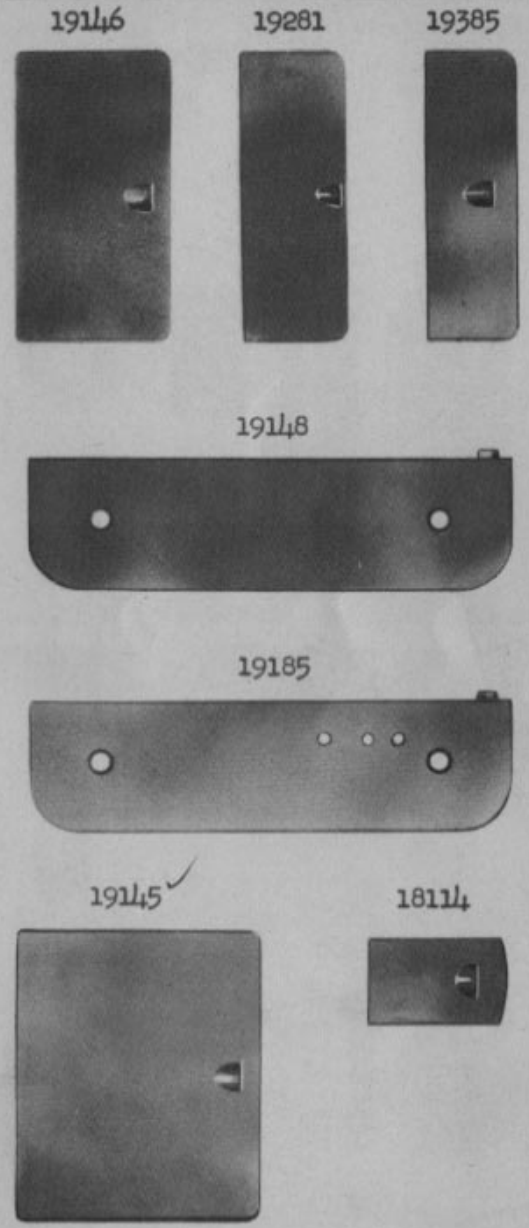


PLATE 8674-FULL SIZE

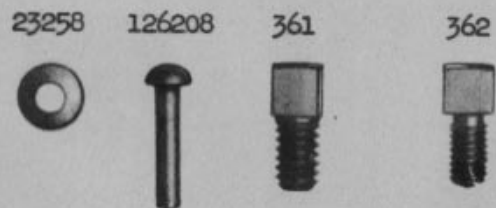
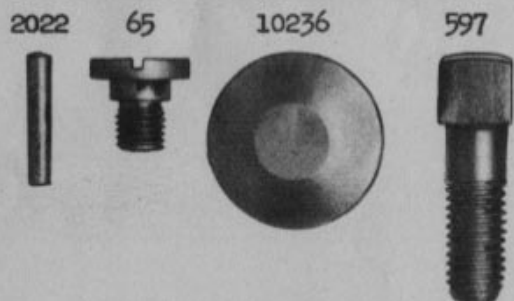
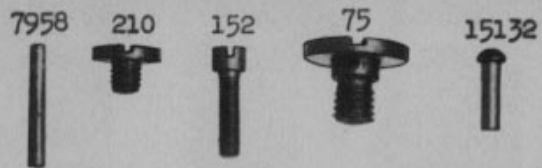


PLATE 8675-FULL SIZE

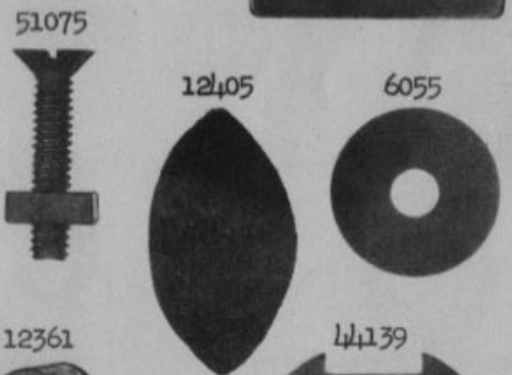
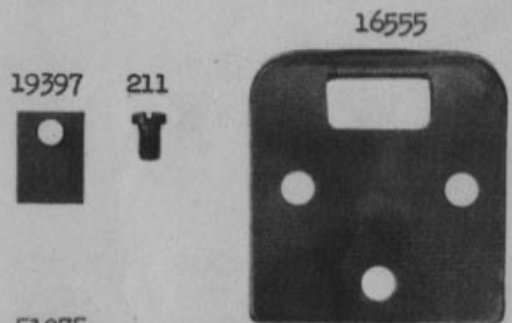
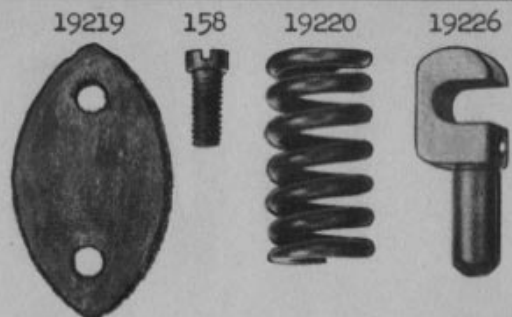


PLATE 8676-FULL SIZE

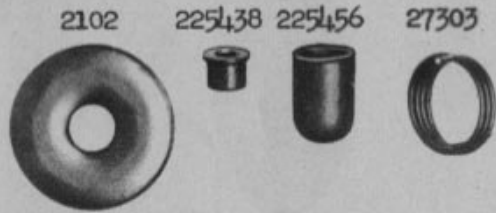
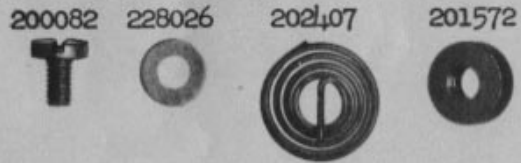
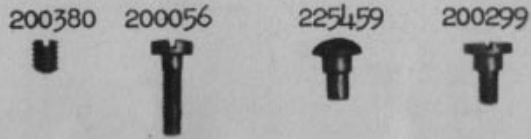
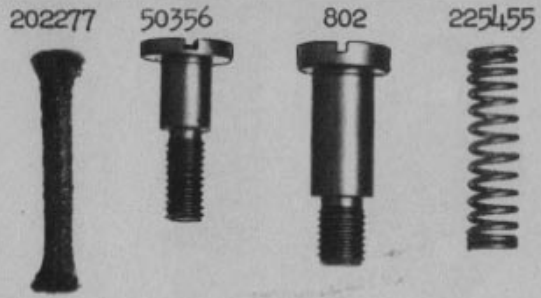


PLATE 8677-ONE-FOURTH SIZE

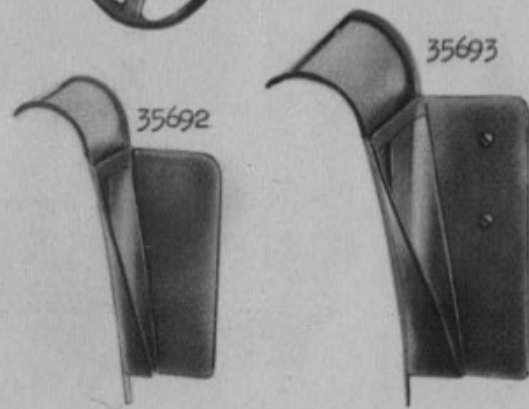
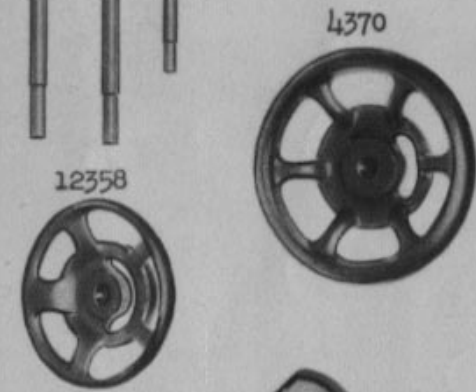
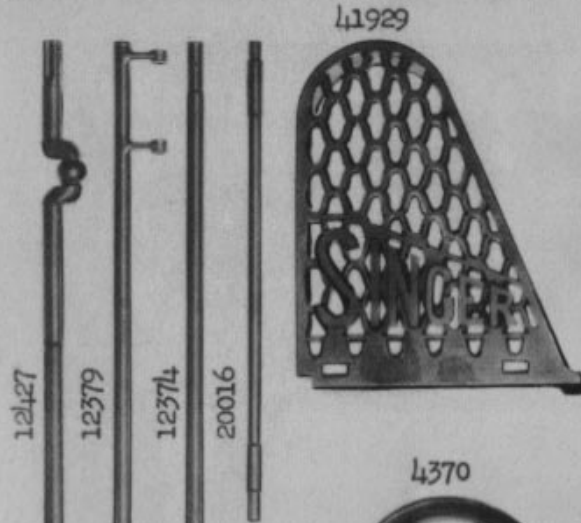


PLATE 8678-ONE-FOURTH SIZE

126036



225382

44212

225433

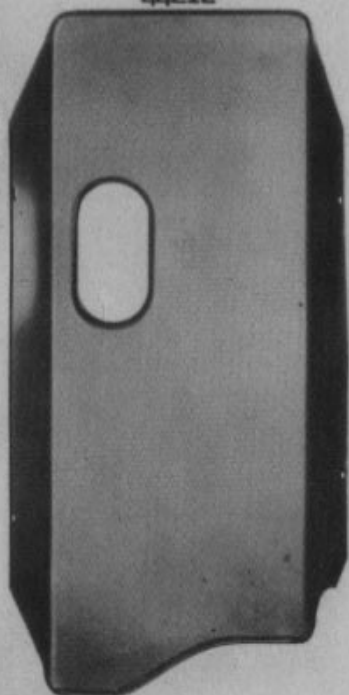


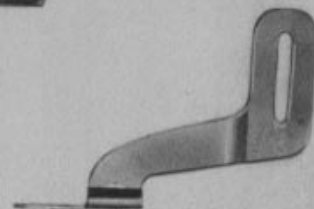
PLATE 8679-ONE-HALF SIZE

35300

26413



19230



35132



35301

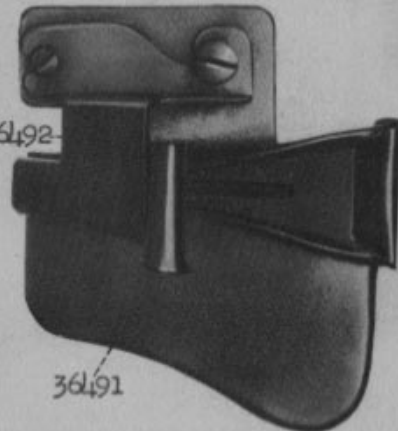


36490

36493



36492



36491

PLATE 8680-ONE-HALF SIZE

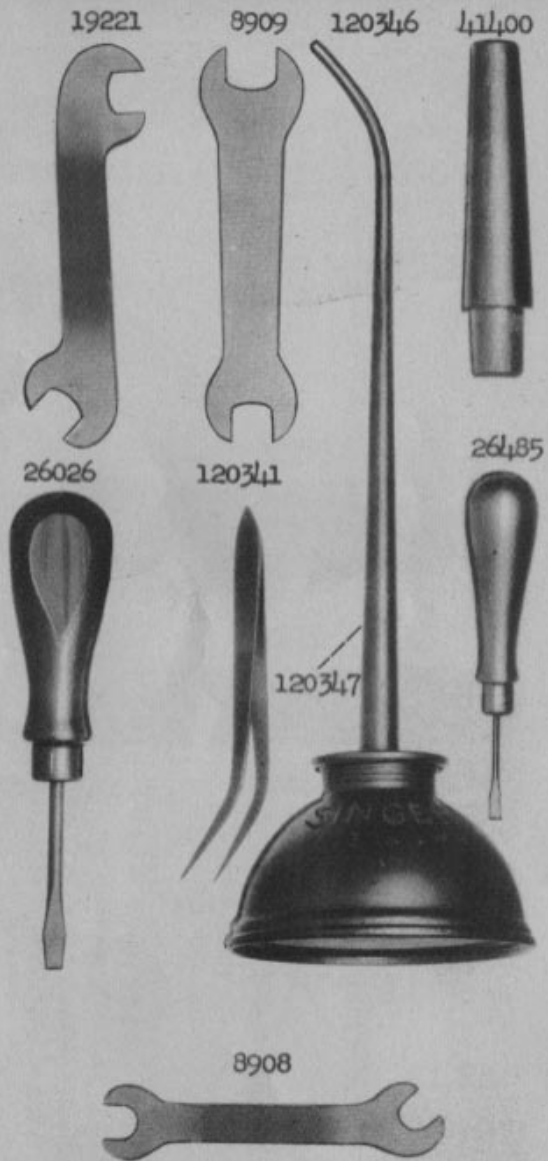


PLATE 8681-ONE-HALF SIZE

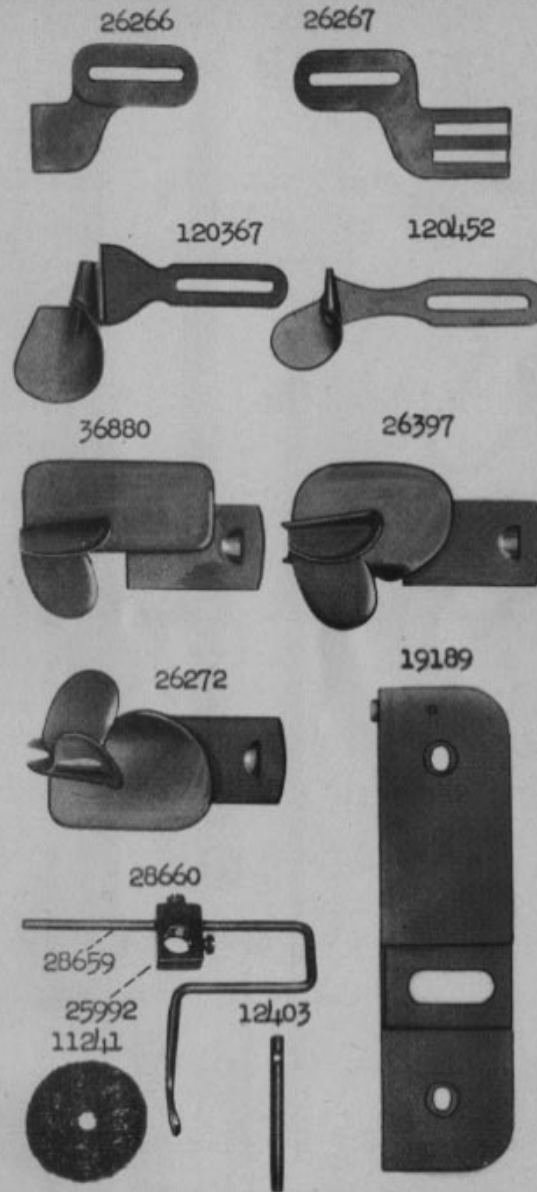


PLATE 8682-ONE-HALF SIZE

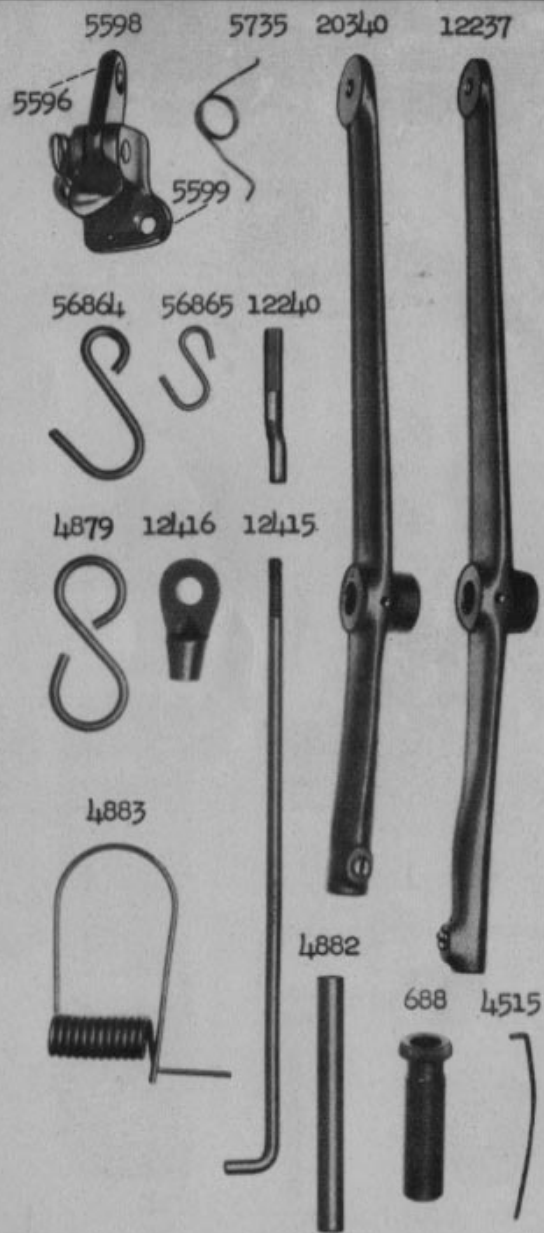


PLATE 8683-ONE-HALF SIZE

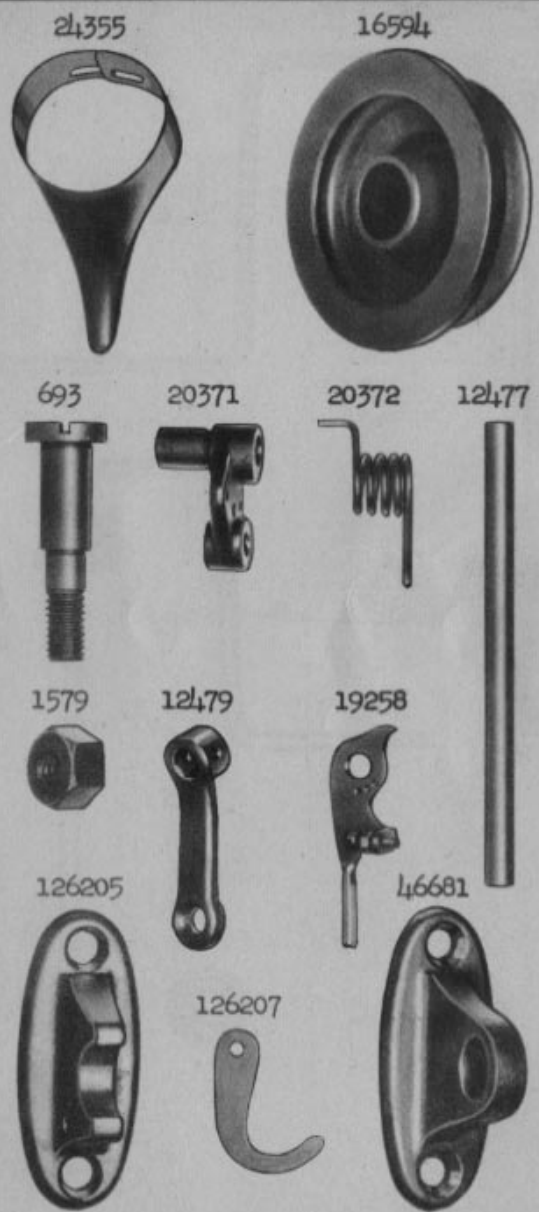


PLATE 8684-ONE-HALF SIZE

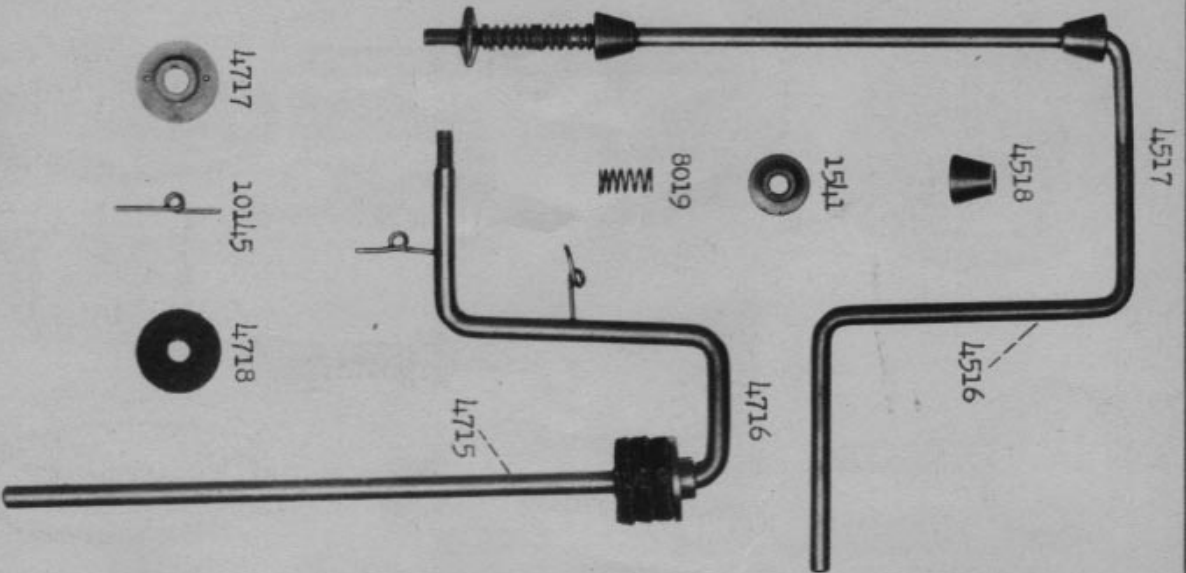


PLATE 8685-ONE-HALF SIZE

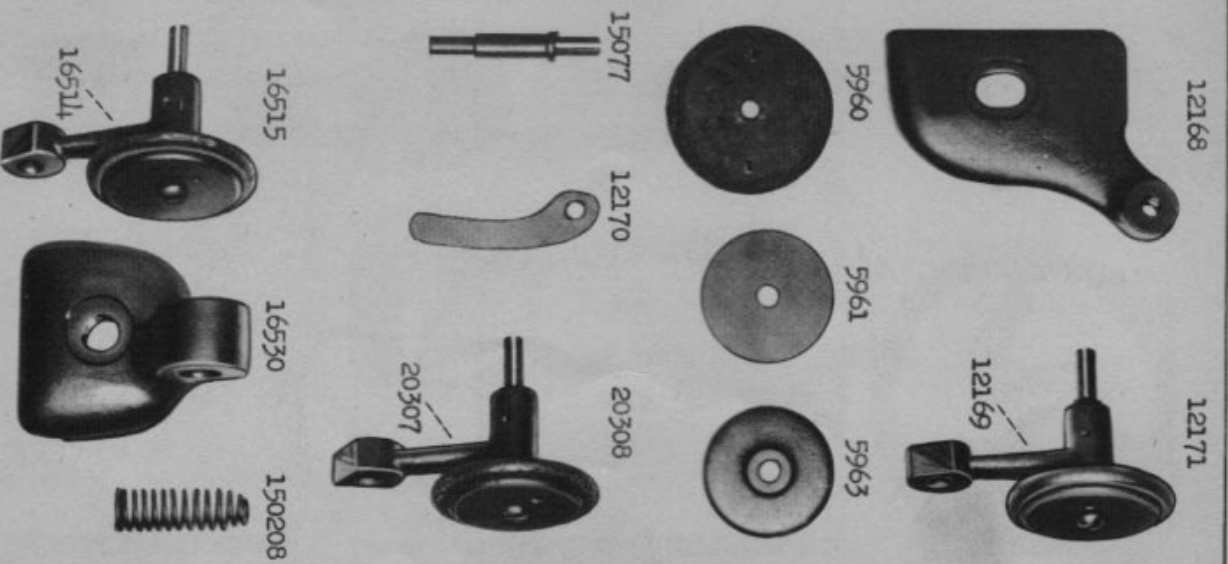


PLATE 8686-ONE-HALF SIZE

202173



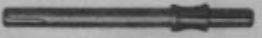
229453



225154



225381



225444



225458



202178



225461



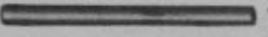
201499

27307



27308

27306



27587



11930



8418



PLATE 8687-ONE-FOURTH SIZE

14233



16518



16992



14081

27637

12475



12458

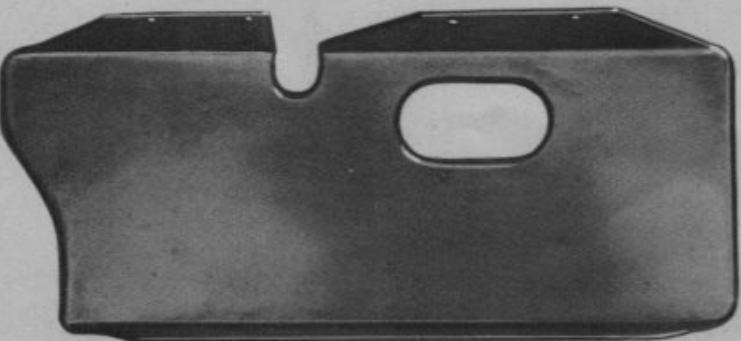


PLATE 8688-ONE-FOURTH SIZE

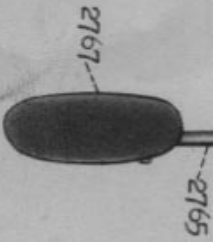
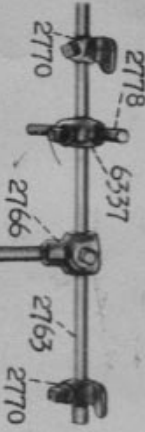


7539



7539

12250



2767



2764



16128

20465

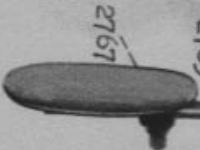
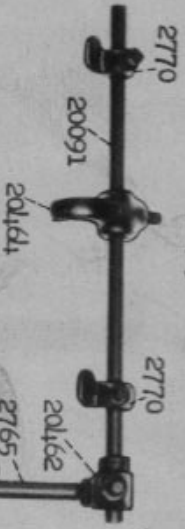
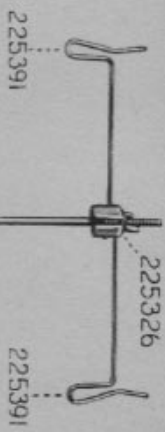


PLATE 20335-ONE-SIXTH SIZE



225258

225391

225326

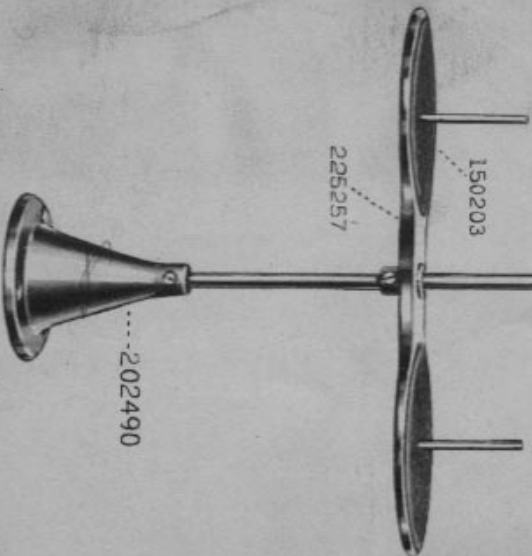
225391

225324

225388

150203

225257



202490