

SINGER
591E200A

MACHINE PARTS CHART
for
SINGER*

591 E200A

NUMERICAL LIST OF PARTS FOR MACHINE 591E200A

PART NO.	DESCRIPTION	PART NO.	DESCRIPTION
691-845	Throat Plate Screw (2)	375578	Top Feed Regulator
2102	Tension Disc (2)	375579	Top Feed Regulator Bracket
11170	Presser Bar Spring Washer	375581	Top Feed Regulator Slide Block
12431-452	Bed Slide	375582	Top Feed Driving Lever Hinge Pin
16380	Oil Removing Light Screen	375583	Top Feed Driving Rod Hinge Pin
32758	Thread Take-up Spring	375584	Top Feed Regulator Bushing
52130	Thread Take-up Lever Thread Eyelet Bushing	375585	Top Feed Regulator Thrust Screw
52454	Thread Retainer	375586	Top Feed Regulator Actuating Plate
55623	Rotating Hook Bobbin	375587	Top Feed Regulator Actuating Plate Set Screw
143042	Rotating Hook Shaft Oil Filter Wick (felt)	375588	Feed Rock Shaft Crank Connection Rod with two 545059
143058	Top Feed Rock Lever Slide Block	375589	Feed Regulator with 504134
143058	Needle Bar Connecting Stud Slide Block	375593	Top Feed Regulator Hole Plug
146610	Presser Bar Lifting Lever Spring	375594	Arm Side Shield
154781	Arm Shaft (horizontal) Thrust Collar Set Screw (2)	375595	Presser Bar Lifter
154781	Presser Bar Lifting Lever Pin Set Screw	375596	Top Feed Regulating Arm Complete, Nos. 375598, 414508 and 375599
154781	Thread Take-up Spring Regulator Set Screw	375598	Top Feed Regulating Arm Pin
154789-451	Bed Slide Spring Screw (2)	375600	Feed Regulator Link
154884	Bed Slide Spring	375601	Feed Regulator Link Hinge Screw
154971	Face Plate Screw (3)	375602	Intermittent Top Feed Actuating Lever Complete
154983	Presser Bar Lifting Lever Connecting Rod Nut (2)	375606	Top Feed Reverse Lever Complete
271055	Top Feed Lifting Driving Rod Needle Bearing	375607	Top Feed Reverse Lever Link
272111	Feed Bar Connecting Link Oil Wick Clamp	375608	Feed Regulating Arm Hinge Screw
374028	Top Feed Regulator Bracket Set Screw	375608	Top Feed Reverse Lever Link Hinge Screw
374100	Needle Bar Crank Position Screw	375609	Top Feed Regulating Arm Screw Stud
375504	Face Plate with 544782, 544875 and 375506	375609	Top Feed Reverse Lever Link Spring Hinge Screw
375506	Face Plate Gasket	375610	Top Feed Regulator Actuating Plate Spring
375507	Arm Side Cover	375611	Top Feed Regulator Actuating Plate Spring Pin
375508	Arm Side Cover Gasket	375612	Feed Reverse Shaft Arm with 544208-002
375510	Arm Top Cover Gasket	375615	Top Feed Regulator Actuating Plate Hinge Screw
375511	Top Feed Lifting Arm Driving Shaft	375616	Feed Regulating Arm Complete
375512	Top Feed Rock Lever Oil Wick	375620	Feed Regulations Stud
375512	Top Feed Rock Arm Driving Shaft Oil Wick	375621	Top Feed Regulating Arm Spring Bracket
375513	Top Feed Rock Arm Driving Shaft O-Ring	375622	Top Feed Regulating Lock Pin
375513	Top Feed Lifting Arm Driving Shaft O-Ring (2)	375623	Intermittent Top Feed Regulating Dial
375514	Top Feed Lifting Arm Driving Shaft Bushing (2)	375624	Intermittent Top Feed Regulating Dial Hinge Screw
375515	Top Feed Rock Arm Driving Shaft Bushing (front)	375627	Feed Reverse Lever with 545046
375516	Top Feed Rock Lever Complete, Nos. 143058, 375519 and 375512	375628	Oil Pipe
375519	Top Feed Rock Lever Slide Block Stop Ring	375631	Intermittent Top Feed Actuating Lever Wire Bracket Complete
375520	Top Feed Rock Fork with 545136-452	375632	Intermittent Top Feed Actuating Lever Wire Sleeve Hinge Screw
375522	Top Feed Lifting Driving Arm with 414508	375633	Intermittent Top Feed Actuating Lever Wire Complete
375524	Top Feed Lifting Driving Arm Hinge Screw	375634	Intermittent Top Feed Actuating Lever Wire Adjusting Screw
375525	Top Feed Lifting Driving Rod with 271055 and 544875	375635	Intermittent Top Feed Actuating Lever Wire Guide Tube
375527	Arm Shaft (horizontal) with Needle Bar Crank and Top Feed Lifting Cam Complete, Nos. 414296, 504095, 504117, 374100 and 375529	375637	Top Feed Dog Set Screw
375529	Top Feed Lifting Cam 375531 with 544104	375638	Intermittent Top Feed Actuating Lever Wire Bracket
375531	Top Feed Lifting Cam Position Pin	375639	Intermittent Top Feed Actuating Lever Wire Bracket Hinge Screw
375532	Top Feed Lifting Lever with 414058	375640	Intermittent Top Feed Actuating Lever Wire Adjusting Sleeve
375535	Top Feed Lifting Lever Roller	375646	Intermittent Top Feed Actuating Lever Wire Guide
375536	Top Feed Rock Arm with 540656	375649	Feed Reverse Lever Spring
375537	Top Feed Rock Arm with 543801-015 and 414508	375650	Feed Reverse Lever Spring Spacer
375538	Top Feed Adjusting Spring	375651	Feed Reverse Lever Spring Washer
375539	Top Feed Adjusting Spring Stud	375652	Feed Reverse Lever Spring Screw
375540	Top Feed Adjusting Spring Nut	375653	Feed Reverse Lever Stop Pin
375541	Top Feed Adjusting Spring Lock Nut	375654	Top Feed Regulating Dial
375542	Top Feed Lifting Crank	375657	Intermittent Top Feed Actuating Lever Wire Clasp
375543	Top Feed Dog Bracket with 544207-001	375659	Intermittent Top Feed Actuating Lever Shaft Bushing
375545	Vibrating Presser Foot Bracket with 375713 and 544208-001	375660	Feed Reverse Lever Shaft
375547	Vibrating Presser Foot Bracket Pin	375661	Feed Regulator Stud
375548	Presser Foot Complete	375662	Feed Reverse Lever Stopper Pin Cover
375552	Top Feed Dog	375663	Top Feed Regulator Stopper Plate
375553	Throat Plate (small needle hole)	375678	Top Feed Regulating Arm Spring
375554	Feed Dog	375681	Presser Foot Shank Pin
375555	Top Feed Rock Arm Link	375682	Presser Foot Shank Spring
375556	Top Feed Rock Arm Link Hinge Stud	375683	Top Feed Lifting Lever Roller Snap Ring
375557	Presser Bar	375684	Feed Rock Shaft Driving Frame Complete, Nos. 375616, 540636, 540639, 540644, 375558, 540649, 540650, 540652, 544156, 548091, two each 540655, 540656, 540657 and 549288
375558	Arm Shaft Bushing (front) 375559 with 540722	375687	Feed Reverse Lever Shaft Complete, Nos. 375660, 540547 and 545825
375559	Arm Shaft Bushing (front)	375689	Oil Pipe 375628 with 545846 and 545847
375560	Feed Cam with two 545313	375690	Intermittent Top Feed Stopper Pin Collar
375562	Top Feed Rock Shaft	375713	Vibrating Presser Foot Bracket Oil Wick
375563	Top Feed Rock Shaft Bushing (front)	408572	Intermittent Top Feed Actuating Lever Wire Support Set Screw Washer
375563	Top Feed Rock Shaft Bushing (center)	410026	Rotating Hook Bobbin Case Latch
375563	Top Feed Rock Shaft Bushing (center)	410027	Rotating Hook Bobbin Case Latch Lever
375563	Top Feed Rock Shaft Bushing (back)	410713	Arm Top Cover Gasket
375566	Top Feed Rock Shaft Collar with two 544204-001		
375567	Oil Wick Holder Complete		
375568	Oil Wick Holder and Pipe		
375571	Needle Bar Thread Guard		
375572	Top Feed Rock Shaft Crank with 414508		
375574	Top Feed Driving Rod with two 545059		
375575	Top Feed Driving Lever with two 504134		

NUMERICAL LIST OF PARTS FOR MACHINE 591E200A

PART NO.	DESCRIPTION	PART NO.	DESCRIPTION
410718	Presser Bar Lifting Lever with 154781	505151	Tension Releasing Lever Hinge Pin
410720	Feed Reverse Lever Hinge Stud Flanged Bushing	505152	Tension Releasing Lever Spring
410746	Feed Rock Shaft Driving Frame Hinge Pin (front)	505317-452	Bed Slide Complete, Nos. 12431-452, 154884 and two 154789-451
411154	Tension Regulating Thumb Nut Washer	505356	Rotating Hook Bobbin Case Latch Spring
414126	Rotating Hook and Rotating Hook Bobbin Case Holder Complete, Nos. 545951 and 414127	505575	Presser Bar Spring
414127	Rotating Hook Bobbin Case Holder	505647	Rotating Hook Shaft Oil Filter Wick Holder
414139	Rotating Hook, Rotating Hook Bobbin Case Holder and Rotating Hook Bobbin Case Complete, Nos. 544745 and 414126	505648	Rotating Hook Shaft Oil Filter Complete
414242	Arm Top Cover with 410713	505649	Presser Bar Bushing (lower)
414273	Tension Releasing Disc	540435	Feed Regulating Dial Lock Pin
414274	Tension Complete, Nos. 32758, 411154, 414273, 540682, 540684, 541182, 545898, 546928 and two 2102	540450	Needle Bar Connecting Stud and Slide Block
414285	Feed Lifting Rock Shaft	540476	Thread Take-up Crank Bearing Plate
414286	Feed Lifting Rock Shaft Complete, Nos. 414285, 502987 and 545810	540524	Needle Bar Bushing (lower)
414287	Feed Rock Shaft Complete, Nos. 414288, 502987 and 545839	540528	Needle Bar Bushing (lower) Felt
414288	Feed Rock Shaft	540533	Thread Take-up Spring Regulator O-ring
414296	Arm Shaft (horizontal)	540534	Thread Take-up Spring Regulator Rubber Cap
414508	Top Feed Lifting Lever Pinch Screw	540536	Feed Bar Carrier
414508	Top Feed Rock Arm Pinch Screw	540537	Feed Bar Carrier 540536 with Three 504013
414508	Top Feed Lifting Driving Arm Pinch Screw	540538	Feed Bar Carrier Oil Wick (felt)
414508	Top Feed Regulating Arm Pinch Screw	540541	Feed Lifting Rock Shaft Oil Wick (outer) (cotton)
502987	Feed Lifting Rock Shaft Oil Plug	540541	Feed Rock Shaft Oil Wick (outer) (cotton)
502987	Feed Rock Shaft Oil Plug	540544	Feed Bar Complete, Nos. 540537, 540538, 545789, 545791, 545808, 545987 and two 504103
504002	Arm Shaft (horizontal) Flanged Bushing (back) Set Screw	540547	Feed Bar Connecting Link Oil Wick (cotton)
504002	Arm Shaft (horizontal) Bushing (center) Set Screw	540549	Thread Guard (side of arm)
504002	Arm Shaft (horizontal) Flanged Bushing (front) Set Screw	540551	Arm Shaft (upright)
504002	Rotating Hook Shaft Bushing (back) Set Screw	540553	Oil Removing Pump (body)
504002	Rotating Hook Shaft Bushing (front) Set Screw	540555	Oil Removing Pump Bracket
504002	Thread Take-up Lever Link Hinge Stud Set Screw	540556	Oil Removing Pump Piston
504007	Feed Lifting Rock Shaft Collar Set Screw (4)	540557	Oil Removing Pump Piston Spring Bracket
504007	Feed Rock Shaft Collar Set Screw (2)	540561	Oil Removing Tube
504010-451	Arm Side Shield Screw	540608	Arm Shaft (horizontal) Thrust Collar with two 154781
504010-451	Oil Removing Pump Piston Spring Bracket Set Screw	540617	Bell Crank Complete
504010-451	Presser Foot Set Screw	540624	Intermittent Top Feed Regulating Dial Lock Pin
504010-451	Slack Thread Regulator Screw	540625	Intermittent Top Feed Regulating Dial Lock Pin Spring
504010-451	Thread Take-up Lever Guard Screw	540633	Feed Reverse Lever Shaft Collar with 504134
504013	Thread Take-up Lever Oil Guard Screw	540631	Feed Reverse Lever Hinge Stud Complete, Nos. 540630, 540547 and 545825
504013	Feed Bar Carrier Clamping Screw (2)	540633	Feed Reverse Lever Hinge Stud Collar with 504134
504013	Feed Bar Hinge Pin Clamping Screw	540636	Feed Reverse Lever Hinge Stud Crank Connecting Link
504025	Bell Crank Bracket Set Screw (2)	540639	Feed Reverse Lever Spring
504029	Feed Rock Shaft Driving Frame Hinge Pin Set Screw (2)	540641	Feed Reverse Lever Spring Retainer
504047	Tension Stud Set Screw	540644	Feed Rock Shaft Crank with 545181 and 549183
504051	Feed Dog Screw (2)	540649	Feed Rock Shaft Crank Connecting Rod Pin
504051	Intermittent Top Feed Actuating Lever Wire Support Set Screw (2)	540650	Feed Rock Shaft Crank Pin
504064	Arm Screw (small)	540652	Feed Rock Shaft Driving Frame with 545264 and two 545072
504066	Arm Shaft (horizontal) Bevel Gear Set Screw (2)	540653	Feed Rock Shaft Driving Frame Hinge Pin (back)
504071	Oil Pump (centrifugal) (body) Screw (2)	540655	Feed Rock Shaft Driving Link (large) (2)
504074	Feed Regulating Dial Cap Screw	540656-001	Feed Rock Shaft Driving Link (small) (2)
504134	Top Feed Driving Lever Hinge Pin Set Screw	540657	Feed Rock Shaft Driving Link (small) Pin (2)
504084	Rotating Hook Bobbin Case Holder Position Bracket Screw	540660	Needle Bar Connecting Link
504086	Rotating Hook Bobbin Case Tension Regulating Screw	540661	Needle Bar Connecting Link 540660 with 540450
504087	Rotating Hook Bobbin Case Tension Spring Screw	504662	Needle Bar Connecting Link Roller Bearing
504094	Feed Rock Shaft Flanged Bushing (front) Set Screw	540662	Thread Take-up Lever Roller Bearing
504094	Thread Retainer Set Screw	540670	Presser Bar Lifting Lever Link
504095	Thread Take-up Crank Set Screw	540673	Tension Releasing Lever (body) 545894 with 545057 and 540674
504099	Arm Top Cover Screw (4)	540674	Tension Releasing Lever Segment
504101	Arm Shaft (upright) Bevel Gear (lower) Set Screw (2)	540676	Thread Take-up Lever with 52130
504101	Arm Shaft (upright) Bevel Gear (upper) Set Screw (2)	540677	Thread Take-up Crank (for 200A)
504101	Rotating Hook Shaft Bevel Gear Set Screw (2)	540678	Thread Take-up Crank 540677 with 504118, 540661 and 540662
504103	Feed Bar Connecting Link Cap Screw (2)	540682	Tension Spring
504112	Needle Set Screw	540684	Tension Releasing Pin
504117	Thread Take-up Crank Clamping Screw	540702	Needle Bar (hollow) with 504112
504118	Needle Bar Connecting Link Cap Screw	540703	Needle Bar Bushing (upper) Felt
504119	Machine Pulley Set Screw (2)	540706	Arm Shaft (horizontal) Flanged Bushing (back)
504129	Needle Bar Bushing (lower) Set Screw	540707	Arm Shaft (horizontal) Flanged Bushing (back) Oil Seal
504129	Needle Bar Bushing (upper) Set Screw	540708	Arm Shaft (horizontal) Flanged Bushing (back) Ring
504129	Presser Bar Bushing (lower) Set Screw	540714	Oil Removing Tube Retaining Spring
504134	Top Feed Driving Lever Hinge Pin Set Screw	540719	Oil Pipe Clamping Sleeve Nut
504134	Top Feed Driving Rod Hinge Pin Set Screw	540722	Arm Shaft (horizontal) Flanged Bushing (front) Oil Drain Tube Tape
504134	Feed Regulator Link Hinge Stud Set Screw	540762	Thread Guide
504134	Feed Reverse Lever Hinge Stud Collar Set Screw	540767	Rotating Hook Bobbin Case Tension Spring
504134	Rotating Hook Shaft Oil Retaining Collar Set Screw (2)	540771	Needle Bar Bushing (lower) Thread Eyelet
504145	Oil Removing Tube Retaining Clamp Screw	541182	Tension Regulating Thumb Nut
505001	Arm Dowel Pin (2)	543327	Intermittent Top Feed Actuating Lever Wire Support
		543367	Thread Take-up Lever Link
		543368	Thread Take-up Lever Link Hinge Stud
		543369	Thread Take-up Lever Link Hinge Stud 543368 with 543370

NUMERICAL LIST OF PARTS FOR MACHINE 591R200A

PART NO.	DESCRIPTION	PART NO.	DESCRIPTION
543370	Thread Take-up Lever Link Hinge Stud Oil Wick (cotton)	545767	Arm Shaft (upright) Bushing (upper)
543371	Oil Removing Tube Retaining Clamp	545775	Bed Hole Plug
543416	Thread Take-up Complete, Nos. 540662, 540676, 540678, 543367 and 543369	545776	Bed Leg (long)
543801-004	Vibrating Presser Foot Bracket Pin Snap Ring (2)	545777	Bed Leg (short) (3)
543801-015	Top Feed Rock Arm Hinge Pin Snap Ring (2)	545788	Feed Bar Connecting Link
543826	Arm Screw (front) Washer (2)	545789	Feed Bar Connecting Link 545788 with 272111 and 540547
544104	Top Feed Lifting Cam Set Screw	545791	Feed Bar Hinge Pin
544156	Feed Regulating Arm Spring Screw	545799	Feed Lifting Rock Shaft Crank (back) Connecting Rod Hinge Stud
544156	Feed Reverse Lever Spring Screw	545806	Feed Lifting Rock Shaft Collar with two 504007 (2)
544204-001	Top Feed Rock Shaft Collar Set Screw (2)	545807	Feed Lifting Rock Shaft Crank (back) with two 549183
544207-001	Top Feed Rock Arm Link Hinge Stud Set Screw	545808	Feed Lifting Rock Shaft Crank (front) with 545043
544208-001	Vibrating Presser Foot Bracket Screw	545810	Feed Lifting Rock Shaft Oil Wick (cotton)
544208-002	Feed Reverse Shaft Arm Set Screw	545812	Feed Lifting Rock Shaft Crank (back) Connecting Rod with two 545059
544244	Rotating Hook Screw (2)	545820	Top Feed Regulating Dial Lock Pin Spring
544246	Rotating Hook Oil Flow Regulating Thumb Screw	545820	Feed Regulating Dial Lock Pin Spring
544290	Top Feed Rock Shaft Crank Pinch Screw	545825	Intermittent Top Feed Actuating Lever Shaft "O" Ring
544290	Top Feed Rock Fork Pinch Screw	545825	Feed Reverse Lever Hinge Stud O-ring
544368	Arm Screw (front) (2)	545825	Top Feed Regulator "O" Ring
544745	Rotating Hook Bobbin Case Complete, Nos. 410026, 410027, 505356 and 544746	545836	Feed Rock Shaft Flanged Bushing (front)
544746	Rotating Hook Bobbin Case with 504086, 504087 and 540767	545837	Feed Rock Shaft Collar with two 504007
544782	Arm Shaft (horizontal) Flanged Bushing (front) Oil Tube Cap Screw	545839	Feed Rock Shaft Oil Wick (cotton)
544782	Arm Shaft (upright) Bevel Gear (upper) Set Screw Hole Plug	545841	Needle Bar Bushing (upper)
544782	Face Plate Plug (small)	545845	Oil Pipe
544782	Arm Hole Plug	545846	Oil Pipe Clamping Sleeve
544873-451	Thread Take-up Lever Guard	545847	Oil Pipe Clamping Sleeve Nut
544875	Top Feed Lifting Oil Plug	545849	Oil Pipe Clamping Sleeve
544875	Top Feed Rock Shaft Hole Plug	545852	Oil Pipe 545845 with 540719 and 545849
544875	Face Plate Plug (large)	545855	Oil Pump (centrifugal) Cover
544881	Needle Bar Connecting Stud with 549380	545856	Oil Pump (centrifugal) Impeller
544886	Thread Take-up Crank Clamping Screw Hole Plug	545857	Oil Pump (centrifugal) Screen Frame
544901	Machine Pulley with two 504119	545858	Oil Pump (centrifugal) Screen Frame
544954	Rotating Hook Shaft Bushing (front)	545872	Presser Bar Lifting Lever Connecting Rod Oil Mist Retaining Disc (felt)
544956	Rotating Hook Shaft Bushing (back)	545873	Presser Bar Lifting Lever Connecting Rod Swivel
544957	Rotating Hook Shaft Bushing (back) Oil Felt	545875	Presser Bar Lifting Lever Pin
544958	Rotating Hook Oil Flow Regulating Thumb Screw Spring	545876	Presser Bar Guide and Pressure Regulating Thumb Screw 549363 with 545403
545033	Arm Screw (back) (2)	545881	Rotating Hook Bobbin Case Holder Position Bracket
545043	Feed Lifting Rock Shaft Crank (front) Clamping Screw	545884	Rotating Hook Shaft
545046	Feed Reverse Lever Pinch Screw	545885	Rotating Hook Shaft 545884 with 505648
545046	Feed Reverse Lever Clamping Screw	545886	Rotating Hook Shaft
545047	Feed Reverse Lever Hinge Stud Cap Screw	545887	Rotating Hook Shaft Bevel Gear (left hand spiral) with two 501101
545049	Oil Pump (centrifugal) Impeller Locking Screw	545890	Rotating Hook Shaft Oil Retaining Collar with two 504134
545050	Oil Pump (centrifugal) Screen Frame Screw (3)	545892	Slack Thread Regulator
545051	Oil Wick Holder Screw	545894	Tension Releasing Lever (body)
545053	Presser Bar Lifter Hinge Screw	545898	Tension Stud
545054	Presser Bar Lifting Lever Hinge Screw	545901	Thread Eyelet (side of arm)
545057	Tension Releasing Lever Screw	545908	Thread Take-up Lever Oil Guard with 545909
545059	Feed Rock Shaft Crank Connecting Rod Set Screw (2)	545909	Oil Wick (2)
545059	Top Feed Driving Rod Cap Screw (2)	545909	Thread Take-up Lever Oil Guard Wick (cotton)
545059	Feed Lifting Rock Shaft Crank (back) Connecting Rod Cap Screw (2)	545909	Oil Wick (cotton) (2)
545059	Feed Rock Shaft Crank Connecting Rod Cap Screw (2)	545949	Feed Lifting Rock Shaft Flanged Bushing (2)
545072	Feed Rock Shaft Driving Link (small) Pin Set Screw (2)	545949	Feed Rock Shaft Flanged Bushing (back)
545099	Presser Bar Guide Bracket Clamping and Tension Releaser Screw	545950	Rotating Hook (body) with two 544244
545181	Feed Rock Shaft Crank Connecting Rod Pin Set Screw	545951	Rotating Hook Complete, Nos. 545950, 545954, 545955, three 549187 and four 549186
545181	Feed Rock Shaft Crank Pin Set Screw	545954	Rotating Hook Section
545183	Feed Reverse Lever Spring Retainer Screw	545955	Rotating Hook Thread Guard
545239	Oil Removing Pump Bracket Set Screw (3)	545983	Presser Bar Guide Bracket with 545099
545246-452	Intermittent Top Feed Actuating Lever Wire Bracket Screw	545987	Feed Bar
545246-452	Arm Side Cover Screw (9)	546698	Top Feed Regulator Stopper Screw Washer (2)
545246-452	Top Feed Regulating Arm Spring Bracket Set Screw (2)	546881	Feed Regulating Dial
545264	Feed Rock Shaft Driving Frame Spring Stud	546882	Feed Regulating Stud Head Plate
545313	Feed and Feed Lifting Eccentric Set Screw (2)	546883	Feed Regulating Stud Head Plate Retainer
545403	Presser Bar Guide and Pressure Regulating Thumb Screw Lock Nut	546927	Thread Take-up Spring Regulator with 504047
545425-452	Top Feed Lifting Driving Arm Hinge Screw Nut	546928	Thread Take-up Spring Regulator 546927 with 540533 and 540534
545425-452	Intermittent Top Feed Actuating Lever Wire Adjusting Sleeve Nut	546933	Needle Bar Bushing (lower) 540524 with 540771
545757	Arm Shaft (horizontal) Bevel Gear with two 504066	547671	Presser Foot Set Screw Washer
545758	Arm Shaft (horizontal) Bushing (center)	547671	Top Feed Set Screw Washer
545761	Arm Shaft (horizontal) Flanged Bushing (front) Oil Tube	548970	Presser Bar Lifting Lever Pin Spring
545764	Arm Shaft (upright) Bevel Gear (lower) Right Hand Spiral with two 504101	549128	Thread Eyelet (side of arm) Screw
545765	Arm Shaft (upright) Bevel Gear (upper) Left Hand Spiral with two 504101	549183	Feed Lifting Rock Shaft Crank (back) Clamping Screw (2)
545766	Arm Shaft (upright) Bushing (lower)	549183	Feed Rock Shaft Crank Clamping Screw
		549186	Rotating Hook Thread Guard Screw (4)
		549187	Rotating Hook Section Screw (3)
		549230	Arm Shaft (horizontal) Screw Plug (back)
		549288	Feed Reverse Lever Hinge Stud Crank Connecting Link Screw (2)

NUMERICAL LIST OF PARTS FOR MACHINE 591E200A

PART NO.	DESCRIPTION	PART NO.	DESCRIPTION
549288	Feed Regulating Arm Hinge Screw		MACHINE BASE AND OIL RESERVOIR
549336	Thread Guard (side of arm) Screw		
549356	Top Feed Regulator Stopper Plate Set Screw	375629	Machine Base and Oil Reservoir Complete, Nos. 544977-003, 544978, 545036, 545754 and four 410705
549363	Presser Bar Guide and Pressure Regulating Thumb Screw	410705	Machine Rest (rubber) and Felt Complete (4)
549380	Needle Bar Connecting Stud Clamping Screw	544977-003	Machine Base and Oil Reservoir
549398	Intermittent Top Feed Actuating Lever Wire Guide Wood Screw (2)	544978	Machine Base and Oil Reservoir Gasket
CAT.1955-01	Needle (135 x 65 #14)	545036	Machine Base and Oil Reservoir Oil Drain Plug Screw
		545854	Machine Base and Oil Reservoir Oil Drain Plug Screw Gasket
 ACCESSORIES AND ATTACHMENTS			
41400	Machine Rest Pin (wood)		KNEE LIFTER PARTS
55623	Rotating Hook Bobbin (3)		
375656	Belt Guard with two 544085 and eight 544217-001	375642	Rock Shaft Crank with 375643 (2)
375664	Gathering Guide with two each 545007 and 548167	375643	Rock Shaft Crank Pintch Screw (2)
375672	Wrench	375644	Rock Shaft
375673	Pedal Complete	375645	Rock Shaft Stop Ring (2)
410154	Oil Can (750cc, filled with Singer Type "C" oil)	375685	Rock Shaft Complete, Nos. 414115, 545918, 375644, 544895 with two each 543823-001, 545921, 375645, 375642 and four 545916
418441-003	Wrench (2.5 hex.)	414115	Rock Shaft Knee Arm Plate
418446	Chain with two 418448	414230	Bell Crank Plunger
418448	Chain Hook	543823-001	Rock Shaft Thrust Washer (2)
504030	Cloth Guide Screw	544895	Rock Shaft Knee Arm
505655-011	Bobbin Winder Complete	545061	Rock Shaft Crank Adjusting Screw (4)
505656-005	Thread Unwinder (for two spools) Complete, with three Wood Screw	545405	Rock Shaft Crank Adjusting Screw Nut (4)
540520	Machine Base and Oil Reservoir Cushion (front) with two Wire Nail (2)	545916	Rock Shaft Crank Adjusting Screw 545061 and Nut 545405 (4)
540521	Machine Base and Oil Reservoir Cushion (back) with two Wire Nail (2)	545918	Rock Shaft Knee Arm Hub
540522	Machine Hinge Connection (2)	545921	Rock Shaft Spring (2)
540523	Machine Hinge Connection Cushion (2)		
541513	Screw Driver (large)		
541514	Screw Driver (small)		
541515	Cloth Guide		
543066	Wrench (2.3 hex.)		
544085	Belt Guard (lower) Wood Screw (2)		
544217-001	Belt Guard Screw (4)		
544217-001	Belt Guard Plate Screw (4)		
545007	Gathering Guide Screw (2)		
545754	Machine Base and Oil Reservoir Oil Drain Plug Screw Gasket		
548167	Gathering Guide Screw Washer (2)		
548701	Screw Driver (long)		
CAT. 1955-01	Needle (135 x 65 #14) (3)		

SINGER*

591 E200A

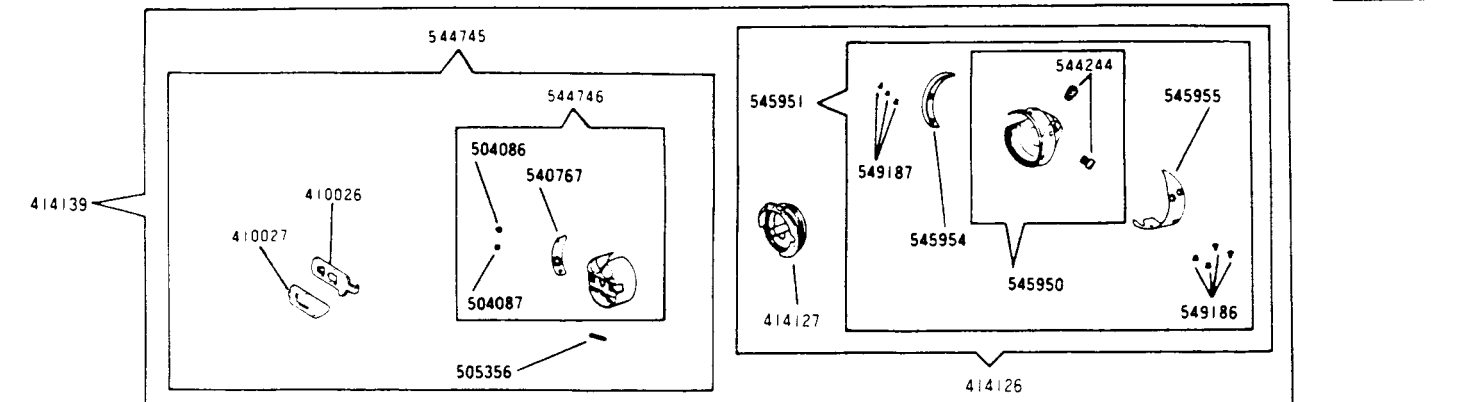
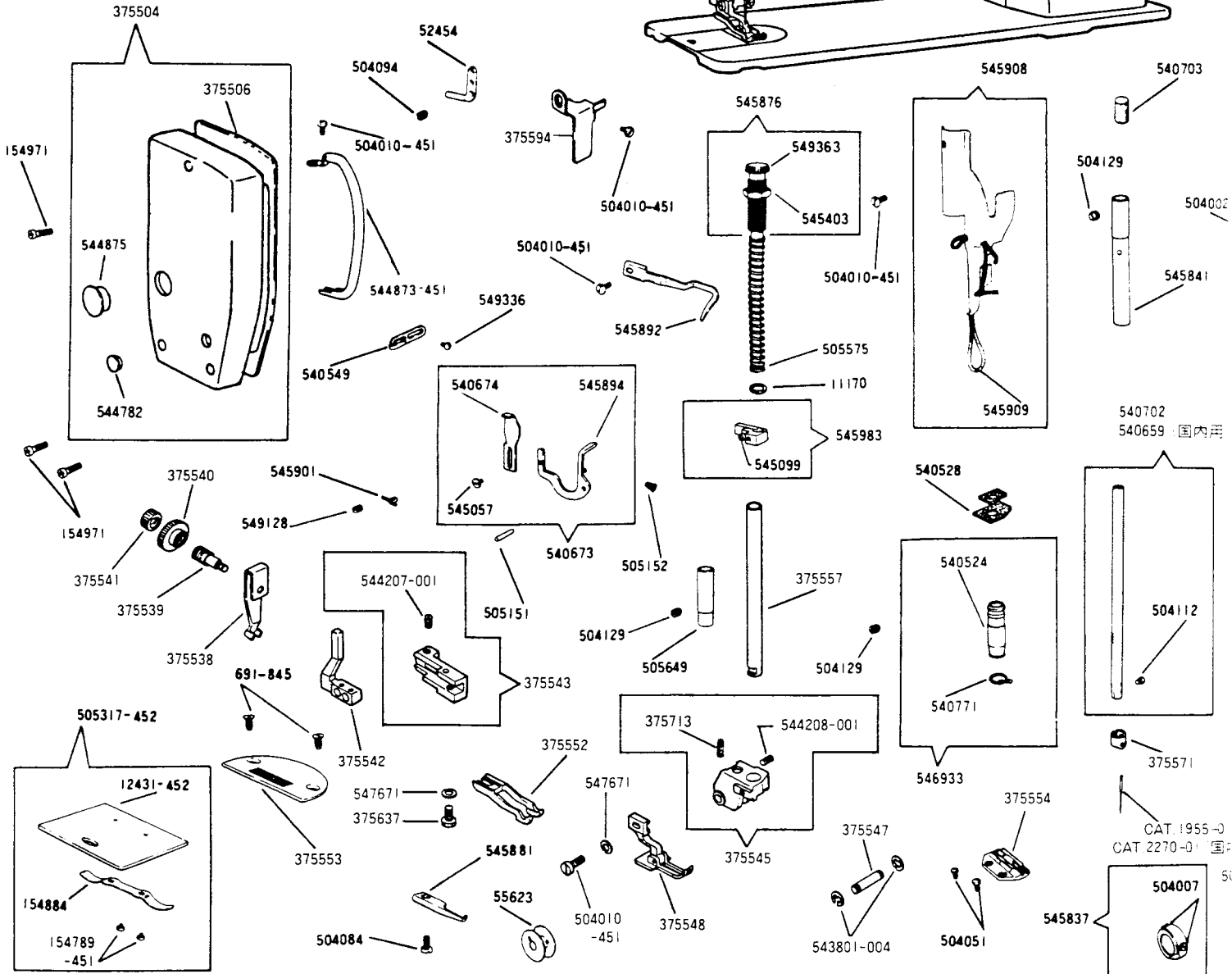
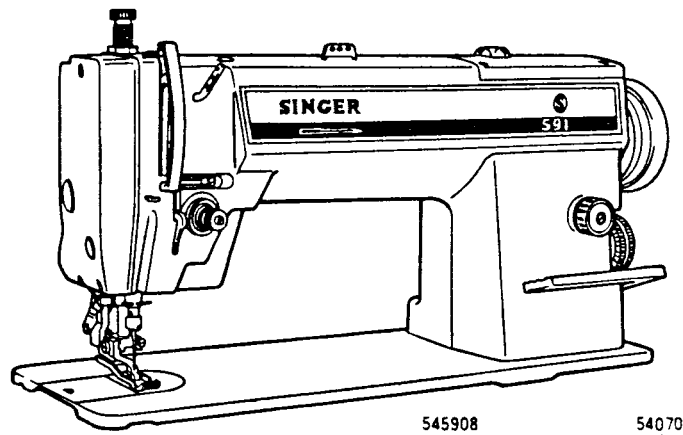

CAT. 1955-D
CAT. 2270-01 国内

50

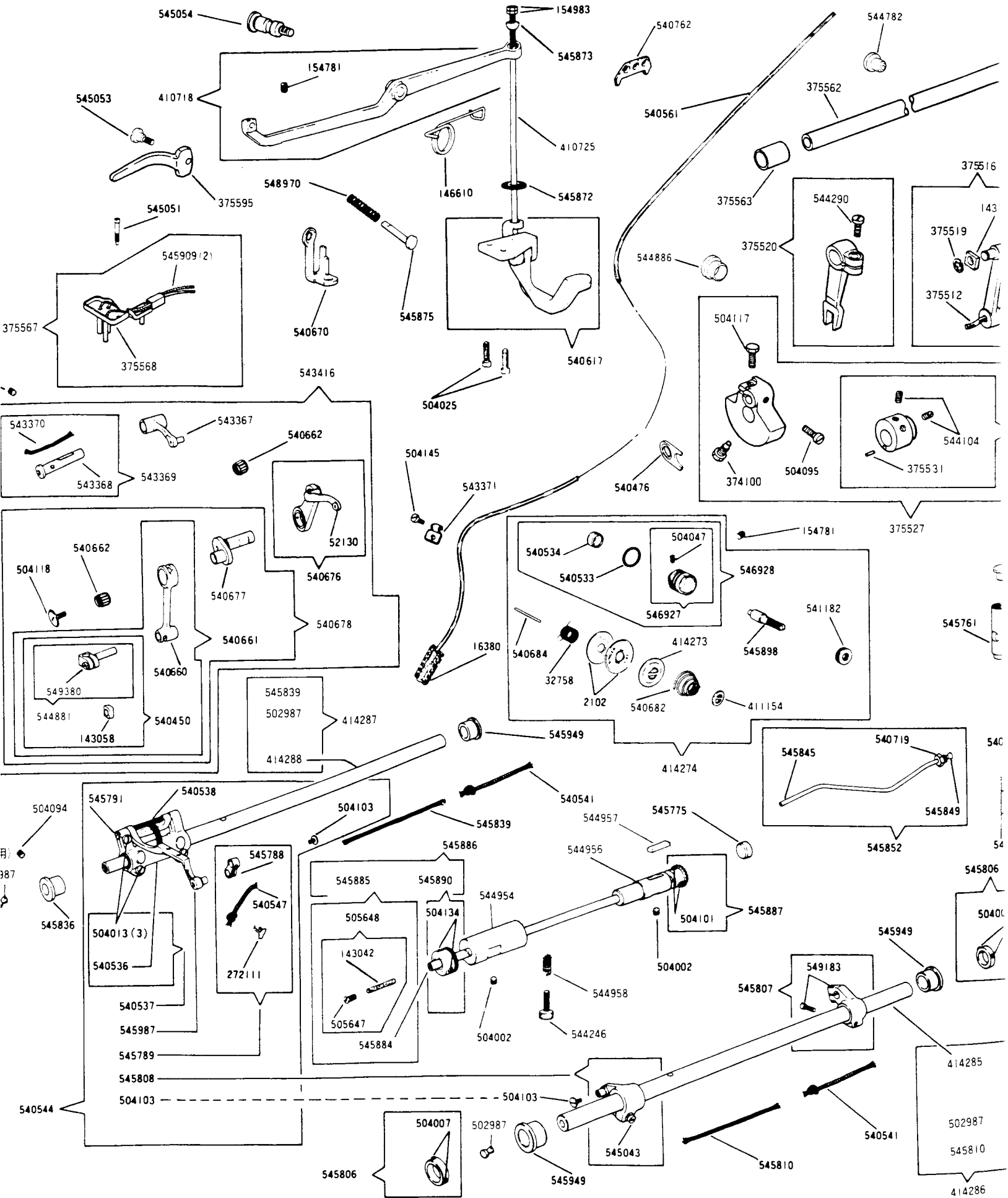

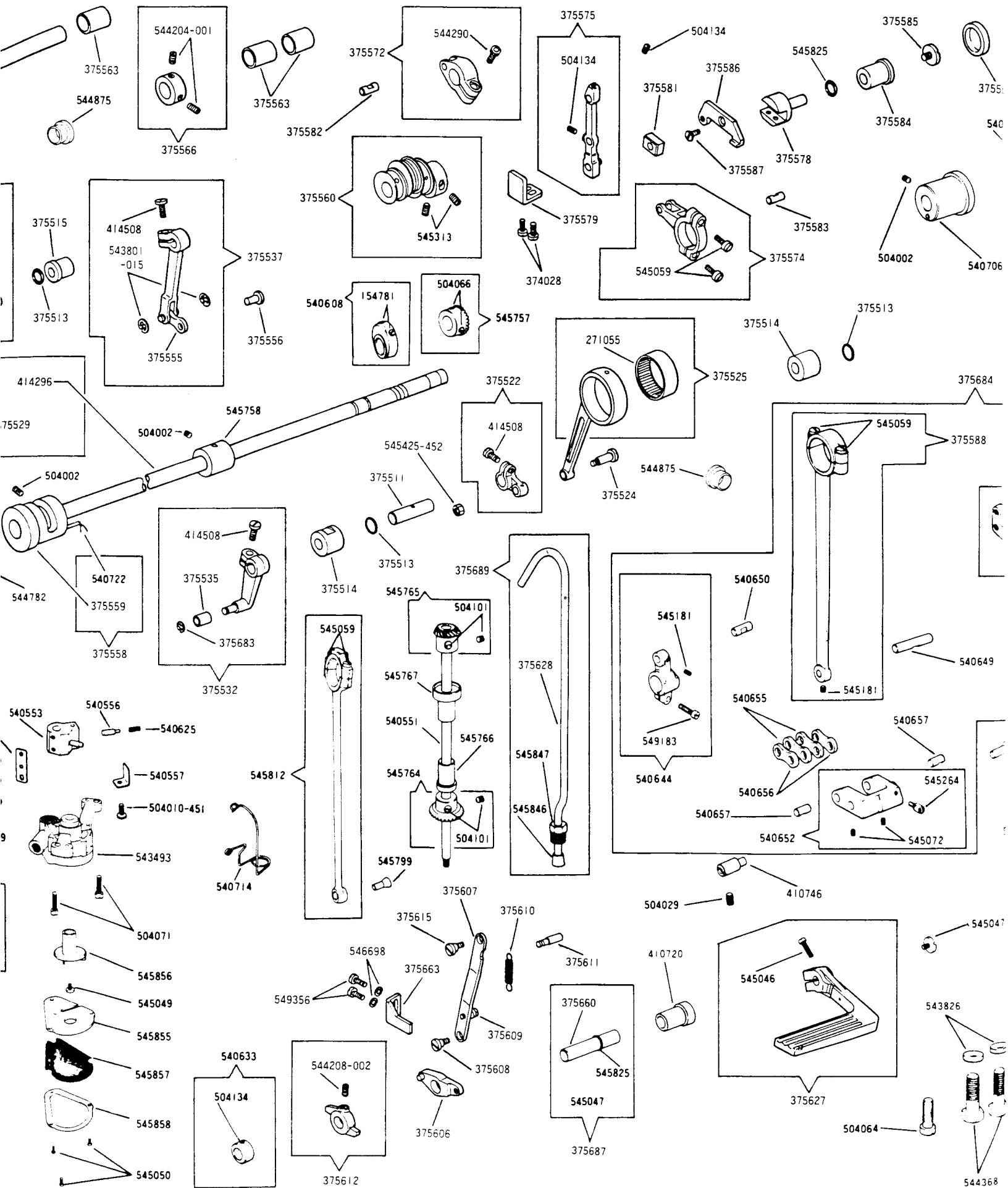

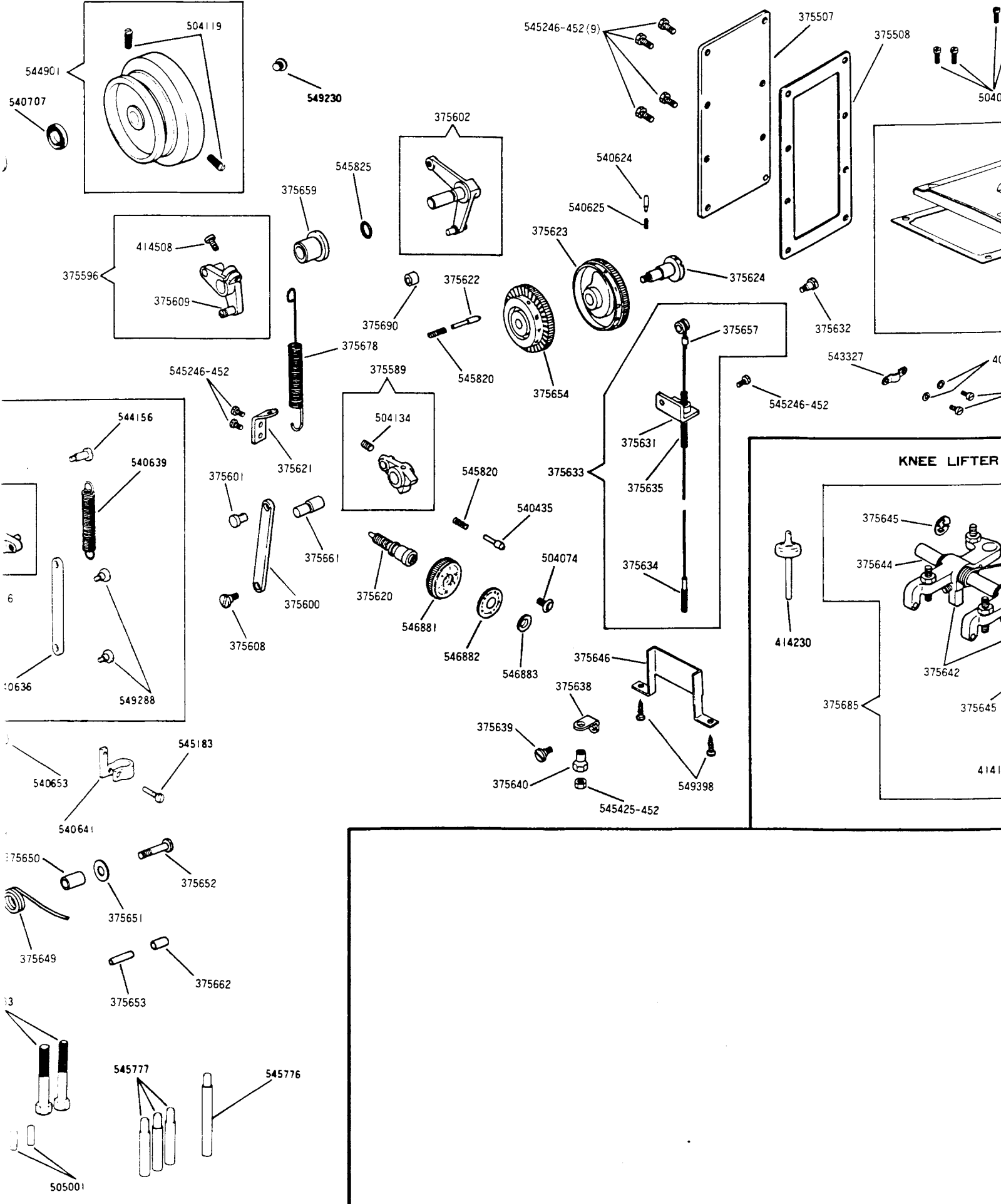

ACCESSORIES AND ATTACHMENTS

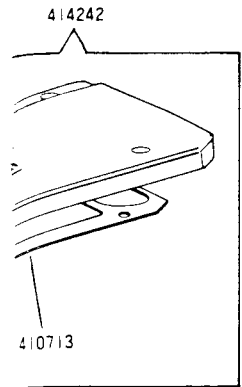

051

RTS

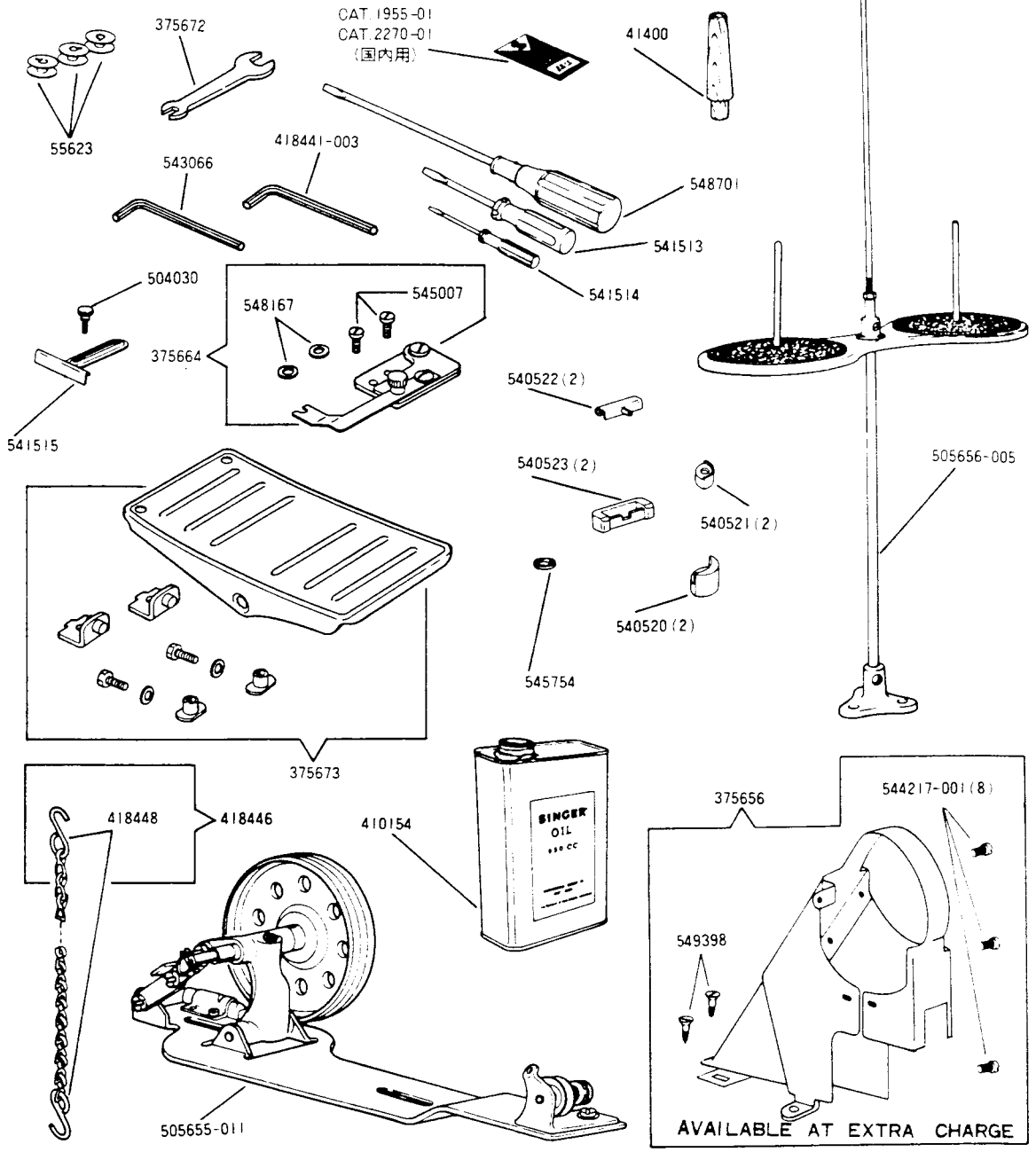
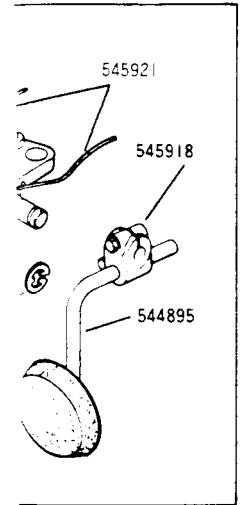

MACHINE BASE AND OIL RESERVOIR

