

Form 8442
March, 1918

PRICE LIST

OF

PARTS



MACHINES

Nos. 6-1 to 6-8

THE SINGER MANUFACTURING COMPANY

COPYRIGHT
U. S. A.,
1916 AND 1918
BY
THE SINGER MANUFACTURING CO.
ALL RIGHTS RESERVED FOR ALL COUNTRIES

INDEX

	PAGE
ACCESSORIES.....	37
BELT SHIFTER.....	35
BOBBIN WINDERS.....	37
DRIVING ATTACHMENT.....	36
FOOT LIFTER PARTS.....	40
IRON WORK FOR 5271.....	41
MACHINE NO. 6-1.....	9
" " 6-2.....	15
" " 6-3.....	15
" " 6-4.....	21
" " 6-5.....	21
" " 6-6.....	28
" " 6-7.....	28
" " 6-8.....	34
NUMERICAL LIST OF PARTS.....	51
OBSOLETE PARTS.....	41
THREAD UNWINDER PARTS.....	38

INSTRUCTIONS FOR ORDERING

In ordering from this list, use ONLY the part NUMBER in the FIRST column.

The number stamped on a Sewing Machine part is in every case the number of the single part only.

Every combination of parts sent out as such has its specific number, which, although not stamped on the parts, must be used when ordering the combination.

Each number always indicates the SAME PART in whatever list it appears, or for whatever machine.

The letters after some of the numbers indicate the style of finish only, as follows:

- A. Hardened, Polished and Plated.
- B. Polished and Plated
- C. Hardened only.
- D. Polished only.
- E. Soft, not Polished.
- F. Hardened and Polished.
- G.
- H. Blued.
- J. Plated only.
- K. Hardened and Plated.
- L. Brass or Gilt.
- M. Oxidized.
- P. Japanned.

These letters MUST BE USED when they appear in the list, and AFTER the number as in the list.

In this series

- 1 to 1500 and 50001 to 51500 are Screw Numbers.
- 1501 to 1800 are Nut Numbers.
- 1801 to 2000 are Roller Numbers.
- 2001 to 50000 and 52001 and upward are numbers of Machine Parts.

The figures in the second column refer only to the plates, illustrating the parts, and are NOT TO BE USED in ordering.

Parts marked with an asterisk (*) are furnished only when repairs are made at factory.

LIST OF PARTS COMPLETE

FOR

MACHINE NO. 6-1

For Cloth or Leather up to 3/4 inch thick. Harness, Flat Belting, etc. Has ratchet wheel feed, roller or flat presser and belt shifter for flat belt.

NO.	PLATE	NAME	EACH
*9206	—	Arm	\$35 00
8702	7250	" Dowel Pin	15
9207	7250	" Oil Tube for oiling 11081	10
50349E	7274	" Screw	15
43263	7270	" Washer	05
9144	7251	" Shaft	8 50
9208	7273	" " Bushing	1 00
434c	7275	" " " Set Screw	04
9105	7252	" Side Cover	25
65D	7275	" " " Hinge Screw	12
8708	7250	" Spool Pin	05
11241	7263	" " " Washer (cloth)	per 100 25
61504	7253	Balance Wheel and Pulley (tight) with two 344c	6 00
344c	7276	Balance Wheel and Pulley (tight) Set Screw	08
*9209	—	Bed	35 00
11054	7251	Crank Connecting Rod with 9141 and two 575E	1 75
*9141	—	Crank Connecting Rod Cap	75
575E	7276	" " " " Screw	05
369c	7276	" " " " Hinge Screw	20
1509E	7275	" " " " " Nut	06
8933	7254	Feed Brake Roll	20
8934	7254	" " " " Spring	05
2269	7250	" " " " Hook	01
8994	7255	" Cam with two 432c	1 00
432c	7275	" " Set Screw	04
8927	7255	" Connecting Link	75
1078c	7276	" " " " Hinge Screw	20
1509E	7275	" " " " " Nut	06

NO.	PLATE	NAME	EACH
8929	7256	Feed Forked Connection	\$2 00
369c	7276	" " " Hinge Screw ..	20
1509E	7275	" " " " " Nut	06
8930	7255	" Regulator	75
17E	7276	" " Hinge Screw	20
50322D	7274	" " Thumb Screw	40
9017	7257	" Rock Shaft	1 75
9210	---	Feed Rock Shaft complete, Nos. 1608E, 2049, 8787, 9010, 9017, 9043, 9211 and 50355E	3 10
9211	7255	Feed Rock Shaft Crank with 50124D	1 00
50124D	7276	" " " " Clamping Screw	12
294c	7276	Feed Rock Shaft Screw Centre	18
1503E	7275	" " " " " Nut..	10
9086	7258	" Wheel	4 00
9212	---	" " 9086 with 9217 and five 145E	10 20
8943	7257	Feed Wheel Frame with 445c and 2269	5 00
445c	7275	" " " Set Screw	03
9213	7257	" " " Shaft	1 50
1015c	7276	" " " " Screw Centre (left)	15
1503E	7275	Feed Wheel Frame Shaft Screw Centre (left) Nut	10
294c	7276	Feed Wheel Frame Shaft Screw Centre (right)	18
1503E	7275	Feed Wheel Frame Shaft Screw Centre (right) Nut	10
429c	7254	Feed Wheel Frame Supporting and Regulating Screw	05
8945	7254	Feed Wheel Friction Block (wood)...	05
8946	7254	" " " " Spring	20
129E	7275	" " " " " Screw	04
8947	7254	" " " " Plate	10
162D	7254	" " " " " Screw ...	04
25881	894	Guide (6 in. face)	40
254D	7274	" Thumb Screw	40
8745	7259	Needle Bar	1 50
9214	7260	" " Bushing	75
448c	7263	" " " Set Screw	03
8746	7259	" " Connecting Link	1 25
370c	7276	" " " " Hinge Screw	18
1509E	7275	Needle Bar Connecting Link Hinge Screw Nut	06

NO.	PLATE	NAME	EACH
16987	7261	Needle Bar Connecting Stud with two 129D	\$2 00
129D	7275	Needle Bar Connecting Stud Clamp- ing Screw	04
16988	7261	Needle Clamp with 149F and 8749 ...	1 25
8749	7260	" " Gib	25
149F	7260	" " Screw	06
16989	7251	Oil Cup	80
11917	7251	" " Cover	25
9084	7260	" " " Hinge Pin	02
2205	7260	" " " Latch Spring	04
207F	7260	" " " " " Screw ...	02
11919	7260	" " Thread Eyelet	05
8953	7260	" or Wax Stripper (felt)	03
11918	7260	" " " " Washer (steel) for 11917	03
8482	7260	Oil or Wax Stripper Washer (steel) for 16989	01
207F	7260	Oil or Wax Stripper Washer Screw	02
16990	7251	Oil Cup complete, Nos. 2205, 8482, 9084, 11917 to 11919, 16989, two 8953 and three 207F	1 25
134D	7275	Oil Cup Screw	05
11081	7262	Oscillating Rock Shaft	8 00
9215	---	Oscillating Rock Shaft complete, Nos. 654c, 9115, 11081, 11165 and two 1503E	9 70
9115	7259	Oscillating Rock Shaft Hinge Pin	1 25
1503E	7275	" " " " " " Nut	10
654c	7276	Oscillating Rock Shaft Hinge Pin Screw Bearing	25
1503E	7275	Oscillating Rock Shaft Hinge Pin Screw Bearing Nut	10
11165	7263	Oscillating Rock Shaft Oil Pad	01
9116	7252	" Shaft	2 00
9152	7263	" " Collar with two 448c ..	30
448c	7263	" " " Set Screw	03
11083	7264	" " Crank with 445c, 1513J and 9120	1 50
9216	7263	Oscillating Shaft Crank Pin	05
445c	7275	" " " Set Screw ..	03
9119	7263	" " " Slide Block..	35
9120	7263	Oscillating Shaft Crank Slide Block complete, Nos. 190D, 1016c, 5968 and 9119	60

NO.	PLATE	NAME	EACH
1535E	7270	Tension Regulating Thumb Nut	\$ 10
8787	7270	" " " " Washer	01
406E	7270	" Screw Stud	25
8788	7270	" Spring	25
8785	—	Tension complete, Nos. 406E, 1535E, 8787, 8788 and two 8786	90
43155	7254	Thread Eyelet (side of arm)	05
43154	7254	" Guard (front of arm)	05
164D	7275	" " " " Screw	04
8796	7257	" Take-up Cam with two 432c	8 00
8714	7250	" " " Pin	15
432c	7275	" " " Set Screw	04
9218	7259	" " Lever with 1513J, 1883 and 9219	2 25
10D	7274	Thread Take-up Lever Hinge Screw ..	25
1883	7275	" " " Roller and Screw Stud	35
1513J	7263	Thread Take-up Lever Roller and Screw Stud Nut	05
9219	7250	Thread Take-up Lever Thread Eyelet Bushing	25
16947	7271	Thread Take-up Spring	10
8077	7261	" " " Hook	01
43157	7271	" " " Lever with 8077	1 75
9046	7271	Thread Take-up Spring Lever Stop Pin	05
11066	7271	Thread Take-up Spring Regulator with 8077 and 9046	1 50
164D	7275	Thread Take-up Spring Regulator Screw	04
9220	7271	Thread Take-up Staple	20
690D	7275	" " " Screw	05
41544	7250	" " " Washer ..	05
9221	7272	Throat Plate with 225F and 9126, for 9086	1 75
9126	7272	Throat Plate Needle Plate	50
225F	7275	" " " Screw	03
381D	7275	" " Screw	06

For Belt Shifter Parts see Page 35.

MACHINE NO. 6-2

Has Singer Driving Attachment, otherwise same as No. 6-1.

NO.	PLATE	NAME	EACH
9196	7251	Arm Shaft, in place of 9144	\$ 8 50
8982	7253	Balance Wheel with two 344c, in place of 61504	4 00
8983	7250	Balance Wheel Pin	10
344c	7276	" " Set Screw	08

For Driving Attachment see Page 36.

MACHINE NO. 6-3

For Cloth or Leather up to $\frac{3}{4}$ inch thick, Harness, Flat Belting, etc. Has drop feed, roller or flat presser and belt shifter for flat belt.

NO.	PLATE	NAME	EACH
*9206	—	Arm	\$35 00
8702	7250	" Dowel Pin	15
9207	7250	" Oil Tube for oiling 9150	10
50349E	7274	" Screw	15
43263	7270	" " Washer	05
9144	7251	" Shaft	8 50
9208	7273	" " Bushing	1 00
434c	7275	" " " Set Screw	04
9105	7252	" Side Cover	25
65D	7275	" " " Hinge Screw	12
8708	7250	" Spool Pin	05
11241	7263	" " " Washer (cloth) per 100	25
61504	7253	Balance Wheel and Pulley (tight) with two 344c	6 00
344c	7276	Balance Wheel and Pulley (tight) Set Screw	08
*9223	—	Bed	35 00
11054	7251	Crank Connecting Rod with 9141 and two 575E	1 75
*9141	—	Crank Connecting Rod Cap	75
575E	7276	" " " " Screw ..	05
369c	7276	" " " Hinge Screw ..	20
1509E	7275	" " " " " Nut	06

PARTS FOR MACHINE NO. 6-3

NO.	PLATE	NAME	EACH
9151	—	Oscillating Rock Shaft complete, Nos. 654c, 9115, 9150, 11165 and two 1503E	\$9 25
9115	7259	Oscillating Rock Shaft Hinge Pin	1 25
1503E	7275	" " " " "	
		Nut	10
654c	7276	Oscillating Rock Shaft Hinge Pin Screw Bearing	25
1503E	7275	Oscillating Rock Shaft Hinge Pin Screw Bearing Nut	10
11165	7263	Oscillating Rock Shaft Oil Pad	01
9116	7252	" Shaft	2 00
9152	7263	" " Collar with two 448c ..	30
448c	7263	" " " Set Screw	03
9153	—	" " Crank	2 00
9154	7255	Oscillating Shaft Crank complete, Nos. 445c, 1513r, 9120 and 9153 ..	2 70
9216	7263	Oscillating Shaft Crank Pin	05
445c	7275	" " " Set Screw ..	03
9119	7263	" " " Slide Block	35
9120	7263	Oscillating Shaft Crank Slide Block complete, Nos. 190D, 1016c, 5968 and 9119	60
190D	7263	Oscillating Shaft Crank Slide Block Cap Screw	03
5968	7263	Oscillating Shaft Crank Slide Block Cap Screw Washer	02
1016c	7263	Oscillating Shaft Crank Slide Block Screw Stud	25
1513J	7263	Oscillating Shaft Crank Slide Block Screw Stud Nut	05
16994	7257	Presser Bar for 16999	1 25
32880	7265	" " " 43233	1 25
9214	7260	" " Bushing	75
448c	7263	" " " Set Screw	03
16995	7266	" " Guide Bracket with 145D and 965D	2 00
145D	7275	Presser Bar Guide Bracket Adjusting Screw	04
965D	7271	Presser Bar Guide Bracket Clamping Screw	04
9110	7267	Presser Bar Guide Bracket Guide	1 00
135D	7275	" " " " " Screw	05
16996	7267	" " Lifter with 8761 and 8763	1 25
8760	7250	" " " Friction Washer..	03
16D	7274	" " " Hinge Screw	20

PARTS FOR MACHINE NO. 6-3

NO.	PLATE	NAME	EACH
8761	7250	Presser Bar Lifter Stop Pin.....	\$ 05
16997	7266	" " Lifting Link	50
166D	7275	" " " " Cap Screw..	07
8763	7250	" " " " Hinge Stud	25
8973	7250	" " " " " "	
		Pin	05
8765	7250	Presser Bar Lifting Link Hinge Stud Washer	04
11031	7252	Presser Bar Spring (flat)	1 50
58252	7267	" " " Bracket	25
1177D	7275	" " " " Screw	04
4389	7250	" " " Guide Pin	02
50323D	7274	" " " Regulating Screw	10
1606E	7275	" " " " " "	
		Lock Nut	05
16999	5998	Presser Foot with two 346D	5 00
346D	6001	" " Clamping Screw	08
1992	6001	Roller, 2½ in. diam., with 370F and 1509E	3 00
8771	6001	Roller Arm	3 00
423F	6001	" " Adjusting Screw	05
1520E	6001	" " " " Nut	03
43232	6001	" " Bracket with two 346D ..	3 50
346D	6001	" " " Clamping Screw ..	08
8773	6001	" " Lock Spring	10
327D	6001	" " " " Screw	05
307F	6001	" " Screw Centre	06
1513J	6001	" " " " Nut	05
43233	6000	Roller Presser complete, 2½ in. roller, Nos. 327D, 423F, 1520E, 1992, 8771, 8773, 43232 and two each 307F and 1513J	10 00
370F	6001	Roller Screw	18
1509E	6001	" " Nut	06
11910	7268	Shuttle Bobbin	25
19977	7268	" Cylinder	1 50
8961	7268	" " Hinge Pin	02
11853	7268	" " Latch	15
12002	7268	" " " Pin	01
19869	7268	" " " Spring	01
19978	7268	" Frame	1 75
773H	7268	" Tension Regulating Screw ..	05
19979	7268	" " Spring	40
19980	7268	Shuttle (cylinder) 3 in. diam., complete, Nos. 773H, 8961, 11853, 11910, 12002, 19869 and 19977 to 19979 ..	4 30

PARTS FOR MACHINE NO. 6-3

NO.	PLATE	NAME	EACH
8965	7259	Shuttle Driver with 445c	\$3 00
9216	7263	" " Pin	05
445c	7275	" " Set Screw	03
11832	7255	" Race Back	1 00
11833	7250	" " Position Pin	01
11834	7255	" " Spring	25
32D	7275	" " " Screw	10
9098	7252	" " Body	2 75
9100	—	Shuttle Race (flexible back) complete, Nos. 32D, 9098, 11832, 11834 and two 11833	4 00
134D	7275	Shuttle Race Screw	05
9099	7252	" " Frame with 11838	2 00
123E	7276	" " Clamping Screw	06
11838	7250	" " Position Pin	03
9122	7269	" " Slide (left)	50
9121	7269	" " " (right)	35
8786	7270	Tension Disc	15
1535E	7270	" Regulating Thumb Nut	10
8787	7270	" " " Washer	01
406E	7270	" Screw Stud	25
8788	7270	" Spring	25
8785	—	Tension complete, Nos. 406E, 1535E, 8787, 8788 and two 8786	90
43155	7254	Thread Eyelet (side of arm)	05
43154	7254	" Guard (front of arm)	05
164D	7275	" " " " " Screw	04
8796	7257	" Take-up Cam with two 432c	8 00
8714	7250	" " " Pin	15
432c	7275	" " " Set Screw	04
9218	7259	" " Lever with 1513J, 1883 and 9219	2 25
10D	7274	Thread Take-up Lever Hinge Screw	25
1883	7275	" " " Roller and Screw Stud	35
1513J	7263	Thread Take-up Lever Roller and Screw Stud Nut	05
9219	7250	Thread Take-up Lever Thread Eyelet Bushing	25
16947	7271	Thread Take-up Spring	10
8077	7261	" " " Hook	01
43157	7271	" " " Lever with 8077	1 75
9046	7271	" " " Stop Pin	05
11066	7271	" " " Regulator with 8077 and 9046	1 50

PARTS FOR MACHINE NO. 6-3

NO.	PLATE	NAME	EACH
164D	7275	Thread Take-up Spring Regulator Screw	\$ 04
9220	7271	Thread Take-up Staple	20
690D	7275	" " " Screw	05
41544	7250	" " " " Washer	05
9230	7277	Throat Plate with 225F and 9231, for 8995	1 75
9231	7277	Throat Plate Needle Plate	50
225F	7275	" " " " Screw	03
381D	7275	" " " Screw	06

For Belt Shifter Parts see Page 35.

MACHINE NO. 6-4

Has Singer Driving Attachment, otherwise same as No. 6-3.

NO.	PLATE	NAME	EACH
9196	7251	Arm Shaft, in place of 9144	\$8 50
8982	7253	Balance Wheel with two 344c, in place of 61504	4 00
8983	7250	Balance Wheel Pin	10
344c	7276	" " Set Screw	08

For Driving Attachment see Page 36.

MACHINE NO. 6-5

For Quilting Sweat Pads up to 1½ in. thick. Has ratchet
wheel feed, vibrating and assisting pressers, foot
lifter and belt shifter for flat belt.

NO.	PLATE	NAME	EACH
*9233	—	Arm	\$35 00
8702	7250	" Dowel Pin	15
9207	7250	" Oil Tube for oiling 11081	10
50349E	7274	" Screw	15
43263	7270	" " Washer	05
9144	7251	" Shaft	8 50
9208	7273	" " Bushing	1 00
434c	7275	" " " Set Screw	04
9105	7252	" Side Cover	25
65D	7275	" " " Hinge Screw	12
8708	7250	" Spool Pin	05

PARTS FOR MACHINE NO. 6-5

NO.	PLATE	NAME	EACH
11241	7263	Arm Spool Pin Washer (cloth)	
	 per 100	\$ 25
61504	7253	Balance Wheel and Pulley (tight) with two 344c	6 00
344c	7276	Balance Wheel and Pulley (tight) Set Screw	08
*9209	—	Bed	35 00
11654	7251	Crank Connecting Rod with 9141 and two 575E	1 75
*9141	—	Crank Connecting Rod Cap	75
575E	7276	" " " " Screw	05
369c	7276	" " " " Hinge Screw	20
1509E	7275	" " " " " Nut	06
8933	7254	Feed Brake Roll	20
8934	7254	" " " " Spring	05
2269	7250	" " " " Hook	01
8994	7255	" Cam with two 432c	1 00
432c	7275	" " Set Screw	04
8927	7255	" Connecting Link	75
1078c	7276	" " " " Hinge Screw for 8930	20
369c	7276	Feed Connecting Link Hinge Screw for 9234	20
1509E	7275	Feed Connecting Link Hinge Screw Nut	06
9234	7257	Feed Forked Connection	2 00
369c	7276	" " " " Hinge Screw	20
1509E	7275	" " " " " Nut	06
8930	7255	" Regulator	75
17E	7276	" " Hinge Screw	20
50322D	7274	" " Thumb Screw	40
9017	7257	" Rock Shaft	1 75
9210	—	Feed Rock Shaft complete, Nos. 1608E, 2049, 8787, 9010, 9017, 9043, 9211 and 50355E	3 10
9211	7255	Feed Rock Shaft Crank with 50124D	1 00
50124D	7276	" " " " Clamping Screw	12
1015c	7276	" " " " Screw Centre (left)	15
1503E	7275	" " " " " " " "	10
294c	7276	Feed Rock Shaft Screw Centre (right)	18
1503E	7275	" " " " " " " "	10
9235	7258	Feed Wheel	4 00
9236	—	" " 9235 with 9014 and five 145E	10 20

PARTS FOR MACHINE NO. 6-5

NO.	PLATE	NAME	EACH
9237	7257	Feed Wheel Frame with 445c and 2269	\$5 00
445c	7275	Feed Wheel Frame Set Screw	03
9213	7257	" " " " Shaft	1 50
1015c	7276	" " " " " Screw Centre (left)	15
1503E	7275	Feed Wheel Frame Shaft Screw Centre (left) Nut	10
294c	7276	Feed Wheel Frame Shaft Screw Centre (right)	18
1503E	7275	Feed Wheel Frame Shaft Screw Centre (right) Nut	10
429c	7254	Feed Wheel Frame Supporting and Regulating Screw	05
8945	7254	Feed Wheel Friction Block (wood)	05
8946	7254	" " " " Spring	20
129E	7275	" " " " " Screw	04
8947	7254	" " " " Plate	10
162D	7254	" " " " " Screw	04
26159	894	Guide (10 in. face)	60
254D	7274	" Thumb Screw	40
9238	7257	Lifting Presser Bar	1 25
9239	7278	" " " " Bushing	75
9240	7278	" " " " Guide Bracket with two 1149c	2 00
1149c	7275	Lifting Presser Bar Guide Bracket Clamping Screw	04
9241	7262	Lifting Presser Bar Spring	30
9242	7278	" " " " " Bracket with two 1149c	2 00
1149c	7275	Lifting Presser Bar Spring Bracket Clamping Screw	04
9243	7278	Lifting Presser Bar Stop Collar with 1149c	50
1149c	7275	Lifting Presser Bar Stop Collar Clamping Screw	04
9244	7278	Lifting Presser Bar Stop Collar Spring	10
9245	7279	" " Foot with two 1149c	2 00
1149c	7275	" " " " Clamping Screw	04
9134	7265	Needle Bar	1 50
9239	7278	" " Bushing	75
9025	7262	" " Connecting Link with 1846	4 00
370c	7276	Needle Bar Connecting Link Hinge Screw	18

NO.	PLATE	NAME	EACH
50355E	7254	Ratchet Pawl Screw Stud	\$ 15
1608E	7254	" " " " Nut	05
8787	7270	" " " " Washer	01
2049	7261	" " " " Pin	01
9043	7254	" " " " Washer	10
9014	7258	" Wheel	6 00
145E	7275	" " Screw	04
11910	7268	Shuttle Bobbin	25
19977	7268	" Cylinder	1 50
8961	7268	" " Hinge Pin	02
11853	7268	" " Latch	15
12002	7268	" " Pin	01
19869	7268	" " Spring	01
19978	7268	" Frame	1 75
773H	7268	" Tension Regulating Screw	05
19979	7268	" " Spring	40
19980	7268	Shuttle (cylinder) 3 in. diam., complete, Nos. 773H, 8961, 11853, 11910, 12002, 19869 and 19977 to 19979	4 00
8965	7259	Shuttle Driver with 445C	3 00
9216	7263	" " Pin	05
445C	7275	" " Set Screw	03
9142	7258	" Race Body with 11838	3 00
123E	7276	" " Clamping Screw	06
11838	7250	" " Position Pin	03
11417	7258	" " Ring	75
164D	7275	" " Screw	04
9143	—	Shuttle Race complete, Nos. 9142, 11417 and two 164D	4 00
64001	7262	Shuttle Race Slide (left)	50
9121	7269	" " (right)	35
8786	7270	Tension Disc	15
1535E	7270	" Regulating Thumb Nut	10
8787	7270	" " " " Washer	01
406E	7270	" Screw Stud	25
8788	7270	" Spring	25
8785	—	Tension complete, Nos. 406E, 1535E, 8787, 8788 and two 8786	90
43155	7254	Thread Eyelet (side of arm)	05
8796	7257	" Take-up Cam with two 432C	8 00
8714	7250	" " Pin	15
432	7275	" " Set Screw	04
64002	7281	" " Lever with 1513J, 1865 and 9219	3 00

NO.	PLATE	NAME	EACH
10D	7274	Thread Take-up Lever Hinge Screw	\$ 25
1865	7261	" " " Roller and Screw Stud	45
1513J	7263	Thread Take-up Lever Roller and Screw Stud Nut	05
9219	7250	Thread Take-up Lever Thread Eyelet Bushing	25
9124	7263	Thread Take-up Spring	15
64003	7278	" " " Regulator	10
164D	7275	" " " " Screw	04
41544	7250	" " " " Washer	05
9132	7278	Thread Take-up Staple	20
690D	7275	" " " Screw	05
41544	7250	" " " " Washer	05
64004	7282	Throat Plate with 225F and 9126, for 9235	1 75
9126	7282	Throat Plate Needle Plate	50
225F	7275	" " " " Screw	03
381D	7275	" " " " Screw	06
64005	7280	Vibrating Presser Bar with 9040 and two 9291	2 00
64006	—	Vibrating Presser Bar complete, Nos. 598D, 8561, 64005 and 64008	3 55
64007	7280	Vibrating Presser Bar Cap and Tension Bracket with 19614 and two each 1547D and 50364C	2 50
134D	7275	Vibrating Presser Bar Cap and Tension Bracket Screw	05
50364C	7278	Vibrating Presser Bar Cap and Tension Bracket Screw Set Screw	06
1547D	7278	Vibrating Presser Bar Cap and Tension Bracket Screw Set Screw Lock Nut	03
8734	7270	Vibrating Presser Bar Spring	08
9040	7280	" " " " Bracket with 19614	50
9291	7250	Vibrating Presser Bar Spring Bracket Rivet	01
19614	7250	Vibrating Presser Bar Spring Hook	05
9013	7286	" " " Washer	03
2049	7261	" " " " Pin	01
64008	7279	" " Foot	1 50
8561	7279	" " " Pin	01
598D	7279	" " " Screw	06

For Belt Shifter Parts see Page 35.

MACHINE NO. 6-6

Has Singer Driving Attachment, otherwise same as No. 6-5.

NO.	PLATE	NAME	EACH
9196	7251	Arm Shaft, in place of 9144	\$8 50
8982	7253	Balance Wheel with two 344c, in place of 61504	4 00
8983	7250	Balance Wheel Pin	10
344c	7276	" " Set Screw	08

For Driving Attachment see Page 36.

MACHINE NO. 6-7

For Quilting Sweat Pads up to 1½ inch thick. Has drop feed, vibrating and assisting pressers, foot lifter and belt shifter for flat belt.

NO.	PLATE	NAME	EACH
*9233	—	Arm	\$35 00
8702	7250	" Dowel Pin	15
9207	7250	" Oil Tube for oiling 9150	10
50349E	7274	" Screw	15
43263	7270	" " Washer	05
9144	7251	" Shaft	8 50
9208	7273	" " Bushing	1 00
434c	7275	" " " Set Screw	04
9105	7252	" Side Cover	25
65D	7275	" " " Hinge Screw	12
8708	7250	" Spool Pin	05
11241	7263	" " " Washer (cloth)	25
		per 100	
61504	7253	Balance Wheel and Pulley (tight)	
		with two 344c	6 00
344c	7276	Balance Wheel and Pulley (tight)	
		Set Screw	08
*9223	—	Bed	35 00
11054	7251	Crank Connecting Rod with 9141 and two 575E	1 75
*9141	—	Crank Connecting Rod Cap	75
575E	7276	" " " " Screw	05
369c	7276	" " " " Hinge Screw	20
1509E	7275	" " " " " "	
		Nut	06
9047	7259	Feed Bar	3 00

PARTS FOR MACHINE NO. 6-7 29

NO.	PLATE	NAME	EACH
304c	7276	Feed Bar Screw Centre	\$ 06
1513J	7263	" " " " Nut	05
8994	7255	" Cam with two 432c	1 00
432c	7275	" " Set Screw	04
8927	7255	" Connecting Link	75
1078c	7276	" " " Hinge Screw	
		for 8930	20
369c	7276	Feed Connecting Link Hinge Screw	
		for 64013	20
1509E	7275	Feed Connecting Link Hinge Screw	
		Nut	06
64012	7283	Feed Dog	1 25
166D	7275	" " Screw	07
64013	7257	" Forked Connection	2 00
369c	7276	" " " Hinge Screw	20
1509E	7275	" " " " " Nut	06
64014	7251	" Lifting Rock Shaft with 134D, 2022 and 19967	1 75
64015	—	Feed Lifting Rock Shaft complete, Nos. 64014 and 64016	4 25
64016	7255	Feed Lifting Rock Shaft Crank with 611D, 1619E and 1926	2 50
611D	7276	Feed Lifting Rock Shaft Crank	
		Clamping Screw	12
1926	7260	Feed Lifting Rock Shaft Crank	
		Roller with 962c	35
962c	7276	Feed Lifting Rock Shaft Crank	
		Roller Screw	15
1619E	7275	Feed Lifting Rock Shaft Crank	
		Roller Screw Nut	05
1015c	7276	Feed Lifting Rock Shaft Screw	
		Centre (left)	15
1503E	7275	Feed Lifting Rock Shaft Screw	
		Centre (left) Nut	10
294c	7276	Feed Lifting Rock Shaft Screw	
		Centre (right)	18
1503E	7275	Feed Lifting Rock Shaft Screw	
		Centre (right) Nut	10
19967	7263	Feed Lifting Rock Shaft Wearing	
		Block	35
2022	7250	Feed Lifting Rock Shaft Wearing	
		Block Position Pin	01
134D	7275	Feed Lifting Rock Shaft Wearing	
		Block Screw	05
8930	7255	Feed Regulator	75
17E	7276	" " Hinge Screw	20

NO.	PLATE	NAME	EACH
50322D	7274	Feed Regulator Thumb Screw.....	\$ 40
9054	7251	" Rock Shaft	3 25
64017	---	Feed Rock Shaft complete, Nos. 9054 and 9211	4 25
9211	7255	Feed Rock Shaft Crank with 50124D	1 00
50124D	7276	" " " " Clamping Screw	12
1015C	7276	Feed Rock Shaft Screw Centre	15
1503E	7275	" " " " " Nut..	10
26159	894	Guide (10 in. face)	60
254D	7274	" Thumb Screw	40
9238	7257	Lifting Presser Bar	1 25
9239	7278	" " " Bushing	75
9240	7278	" " " Guide Bracket with two 1149c	2 00
1149C	7275	Lifting Presser Bar Guide Bracket Clamping Screw	04
9241	7262	Lifting Presser Bar Spring	30
9242	7278	" " " " Bracket with two 1149c	2 00
1149C	7275	Lifting Presser Bar Spring Bracket Clamping Screw	04
9243	7278	Lifting Presser Bar Stop Collar with 1149c	50
1149C	7275	Lifting Presser Bar Stop Collar Clamping Screw	04
9244	7278	Lifting Presser Bar Stop Collar Spring	10
9245	7279	" " Foot with two 1149c ..	2 00
1149C	7275	" " " Clamping Screw	04
9134	7265	Needle Bar	1 50
9239	7278	" " Bushing	75
9025	7262	" " Connecting Link with 1846	4 00
370C	7276	Needle Bar Connecting Link Hinge Screw	18
1509E	7275	Needle Bar Connecting Link Hinge Screw Nut	06
1846	7279	Needle Bar Connecting Link Roller with 9026	30
9026	7279	Needle Bar Connecting Link Roller Pin	10
9246	7278	Needle Bar Connecting Stud with two 1149F	3 00
1149F	7275	Needle Bar Connecting Stud Clamp- ing Screw	04
9060	7260	Needle Clamp with 149F and 8749 ..	90

NO.	PLATE	NAME	EACH
8749	7260	Needle Clamp Gib.....	\$ 25
149F	7260	" " Screw	06
9150	7259	Oscillating Rock Shaft	7 50
9151	---	Oscillating Rock Shaft complete, Nos. 654c, 9115, 9150, 11165 and two 1503E	9 25
9115	7259	Oscillating Rock Shaft Hinge Pin	1 25
1503E	7275	" " " " " Nut	10
654C	7276	Oscillating Rock Shaft Hinge Pin Screw Bearing	25
1503E	7275	Oscillating Rock Shaft Hinge Pin Screw Bearing Nut	10
11165	7263	Oscillating Rock Shaft Oil Pad	01
9116	7252	" Shaft	2 00
9152	7263	" " Collar with two 448c ..	30
448C	7263	" " " Set Screw	03
9153	---	" " Crank	2 00
9154	7255	Oscillating Shaft Crank complete, Nos. 445c, 1513J, 9120 and 9153 ..	2 70
9216	7263	Oscillating Shaft Crank Pin	05
445C	7275	" " " Set Screw ..	03
9119	7263	" " " Slide Block	35
9120	7263	Oscillating Shaft Crank Slide Block complete, Nos. 190D, 1016C, 5968 and 9119	60
190D	7263	Oscillating Shaft Crank Slide Block Cap Screw	03
5968	7263	Oscillating Shaft Crank Slide Block Cap Screw Washer	02
1016C	7263	Oscillating Shaft Crank Slide Block Screw Stud	25
1513J	7263	Oscillating Shaft Crank Slide Block Screw Stud Nut	05
9247	7265	Presser Bar	1 00
9239	7278	" " Bushing	75
9035	7280	" " Guide Bracket with 159D and two 445c	4 00
159D	7279	Presser Bar Guide Bracket Adjusting Screw	03
9248	7280	Presser Bar Guide Bracket Guide	1 00
135D	7275	" " " " " Screw	05
445C	7275	Presser Bar Guide Bracket Set Screw	03
16996	7267	" " Lifter with 8761 and 8763	1 25
8760	7250	" " " Friction Washer..	03

NO.	PLATE	NAME	EACH
16D	7274	Presser Bar Lifter Hinge Screw	\$ 20
8761	7250	" " Stop Pin	05
9030	—	" " Lifting Bell Crank	4 00
9029	7262	Presser Bar Lifting Bell Crank complete, Nos. 129c, 2117, 9030 and 9031	5 00
368C	7279	Presser Bar Lifting Bell Crank Hinge Screw	25
1509E	7275	Presser Bar Lifting Bell Crank Hinge Screw Nut	06
9031	7279	Presser Bar Lifting Bell Crank Toe Piece	1 00
129C	7275	Presser Bar Lifting Bell Crank Toe Piece Screw	04
2117	7250	Presser Bar Lifting Bell Crank Toe Piece Steady Pin	01
9249	7280	Presser Bar Lifting Link	1 00
65D	7275	" " " Cap Screw	12
8763	7250	" " " Hinge Stud	25
8973	7250	" " " " " "	05
8765	7250	Presser Bar Lifting Link Hinge Stud Washer	04
32869	7258	Presser Bar Spring (flat)	1 25
4389	7250	" " Guide Pin	02
32870	7280	" " " " Bracket with 4389	1 00
381D	7275	Presser Bar Spring Guide Pin Bracket Screw	06
567D	7279	Presser Bar Spring Screw Stud	15
340D	7279	Pressure Regulating Screw	06
32871	7280	" " " Bracket	1 00
381D	7275	" " " " " "	06
11910	7268	Shuttle Bobbin	25
19977	7268	" Cylinder	1 50
8961	7268	" " Hinge Pin	02
11853	7268	" " Latch	15
12002	7268	" " " Pin	01
19869	7268	" " " Spring	01
19978	7268	" Frame	1 75
773H	7268	" Tension Regulating Screw	05
19979	7268	" " Spring	40
19980	7268	Shuttle (cylinder) 3 in. diam., complete, Nos. 773H, 8961, 11853, 11910, 12002, 19869 and 19977 to 19979..	4 00

NO.	PLATE	NAME	EACH
8965	7259	Shuttle Driver with 445c	\$3 00
9216	7263	" " Pin	05
445C	7275	" " Set Screw	03
11832	7255	" Race Back	1 00
11833	7250	" " " Position Pin	01
11834	7255	" " " Spring	25
32D	7275	" " " " Screw	10
9098	7252	" " Body	2 75
9100	—	Shuttle Race (flexible back) complete, Nos. 32D, 9098, 11832, 11834 and two 11833	4 00
134D	7275	Shuttle Race Screw	05
9099	7252	" " Frame with 11838	2 00
123E	7276	" " " Clamping Screw	06
11838	7250	" " " Position Pin	03
64001	7262	" " Slide (left)	50
9121	7269	" " " (right)	35
8786	7270	Tension Disc	15
1535E	7270	" Regulating Thumb Nut	10
8787	7270	" " " Washer	01
406E	7270	" Screw Stud	25
8788	7270	" Spring	25
8785	—	Tension complete, Nos. 406E, 1535E, 8787, 8788 and two 8786	90
43155	7254	Thread Eyelet (side of arm)	05
8796	7257	" Take-up Cam with two 432c	8 00
8714	7250	" " " Pin	15
432C	7275	" " " Set Screw	04
64002	7281	" " Lever with 1513A, 1865 and 9219	3 00
10D	7274	Thread Take-up Lever Hinge Screw	25
1865	7261	" " " Roller and Screw Stud	45
1513A	7263	Thread Take-up Lever Roller and Screw Stud Nut	05
9219	7250	Thread Take-up Lever Thread Eyelet Bushing	25
9124	7263	Thread Take-up Spring	15
64003	7278	" " " Regulator	10
164D	7275	" " " " Screw	04
41544	7250	" " " " " Washer	05
9132	7278	Thread Take-up Staple	20
690D	7275	" " " Screw	05
41544	7250	" " " " Washer	05

NO.	PLATE	NAME	EACH
64018	7283	Throat Plate with 225F and 9126, for 64012	\$1 75
9126	7283	Throat Plate Needle Plate	50
225F	7275	" " " " Screw ...	03
381D	7275	" " Screw	06
64005	7280	Vibrating Presser Bar with 9040 and two 9291	2 00
64006	—	Vibrating Presser Bar complete, Nos. 598D, 8561, 64005 and 64008	3 55
64007	7280	Vibrating Presser Bar Cap and Tension Bracket with 19614 and two each 1547D and 50364c	2 50
134D	7275	Vibrating Presser Bar Cap and Tension Bracket Screw	05
50364c	7278	Vibrating Presser Bar Cap and Tension Bracket Screw Set Screw	06
1547D	7278	Vibrating Presser Bar Cap and Tension Bracket Screw Set Screw Lock Nut	03
8734	7270	Vibrating Presser Bar Spring	08
9040	7280	" " " " Bracket with 19614	50
9291	7250	Vibrating Presser Bar Spring Bracket Rivet	01
19614	7250	Vibrating Presser Bar Spring Hook..	05
9013	7286	" " " Washer	03
2049	7261	" " " " Pin	01
64008	7279	" " " Foot	1 50
8561	7279	" " " Pin	01
598D	7279	" " " Screw	06

For Belt Shifter Parts see Page 35.

MACHINE NO. 6-8

Has Singer Driving Attachment, otherwise same as No. 6-7.

NO.	PLATE	NAME	EACH
9196	7251	Arm Shaft, in place of 9144	\$8 50
8982	7253	Balance Wheel with two 344c, in place of 61504	4 00
8983	7250	Balance Wheel Pin	10
344c	7276	" " Set Screw	08

For Driving Attachment see Page 36.

BELT SHIFTER PARTS

NO.	PLATE	NAME	EACH
61504	7253	Balance Wheel and Pulley (tight) with two 344c	\$6 00
344c	7276	Balance Wheel and Pulley (tight) Set Screw	08
6439	—	Chain, length 36 in. to 45 in.	20
Note: When ordering No. 6439 give length required.			
4879	7273	Chain Connecting Link for 4885	03
11446	7250	" Eyelet	04
9137	7273	" Pulley	35
10D	7274	" " Screw	25
8805	7253	Fork	75
432c	7275	" Set Screw	04
8803	7253	Frame with 8804 and two 432c	1 75
8804	7253	" Handle	30
11451	7253	Guide Rod	75
11453	7263	" " Collar with two 448c ..	15
448c	7263	" " " Set Screw	03
3012	7250	" " Pin	01
11454	7273	" " Spring	15
8705	7253	Pulley (loose)	1 50
9104	7273	" " Collar	25
9135	7273	" " Flanged Bushing with two 434c	1 00
434c	7275	Pulley (loose) Flanged Bushing Set Screw	04
9138	7253	Slide Rod	1 50
8873	7250	" " Pin	05
4881	7252	Treadle	30
4882	7273	" Shaft	05
4883	7273	" Spring	10
4884	7252	" Stand	25
4885	7252	Treadle complete, Nos. 4879, 4881 to 4884 and two wood screws 1 in. No. 16	75
9139	—	Belt Shifter complete, Nos. 10D, 3012, 4885, 6439, 8705, 8803, 8805, 8873, 9104, 9135, 9137, 9138, 11446, 11451, 11453, 11454 and 61504	13 50

DRIVING ATTACHMENT

NO.	PLATE	NAME	EACH
8982	7253	Balance Wheel with two 344c	\$4 00
8983	7250	" " Pin	10
	344c 7276	" " Set Screw	08
8984	7273	Brake Block (wood)	05
	9D 7276	" " Screw	20
8985	7253	Friction Pulley with 8986	2 75
8986	7273	" " Centre Bearing	25
8987	7253	" Washer (paper)	10
	401E 7275	" " Screw	02
8988	7253	Lever	1 00
9197	7253	" Bracket	2 00
	497E 7274	" " Bolt with 1522E	05
	1522E 7275	" " " Nut	02
	134D 7275	" Screw	05
8991	7273	" " Washer	06
8992	7273	" Spring	20
9222	7267	" " Hook	15
1520E	7263	" " " Nut	03
6055	7263	" " " Washer	01
9091	7253	Shaft Driving Pulley, 10 in. diam., 1½ in. face, 1⅝ in. bore (sectional) with two 597c	1 40
	597c 7276	Shaft Driving Pulley Clamping Screw	08
27636	7253	Treadle	30
	9082 7250	" Bearing Cotter Pin	01
27637	7251	" Pitman Rod (lower)	05
27638	7260	" " " " Spring	03
27639	7251	" " " (upper)	05
	9079 7251	" " " Clamp with 354c	15
	354c 7275	" " " " Screw	06
27640	7251	Treadle Pitman complete, Nos. 2762, 9079 and 27637 to 27639	35
2878	7253	Treadle Stand	20
2762	7260	" Stop Collar with 362F	10
	362F 7275	" " " Set Screw	05
27642	—	Treadle complete, Nos. 2878, 9082, 27636 and four wood screws 1 in. No. 16	45
27643	—	Treadle and Pitman complete, Nos. 27640 and 27642	80

DRIVING ATTACHMENT

37

NO.	PLATE	NAME	EACH
9198	—	Driving Attachment complete, Nos. 9D, 134D, 1520E, 6055, 8982 to 8985, 8987, 8988, 8991, 8992, 9091, 9197, 9222, 27643, two 497E and four 401E	\$12 50

ACCESSORIES

NO.	PLATE	NAME	EACH
11361	894	Bed Bracket (left) with wood screw 1 in. No. 16	\$ 10
11360	894	Bed Bracket (right) with wood screw 1 in. No. 16	10
	507E 7275	Bed Bracket Bolt with 1515E	02
	1515E 7275	" " " Nut	02
36565	6047	Oiler (copper plated) with 36566	15
36566	6047	" Spout, 9 in. long	08
11831	6047	Screw Driver (large)	20
26026	6047	" " (small)	10
	8908 894	Wrench for 1520 and 1547	08
	8909 894	" " 523, 1513, 1608 and 50323	10
	8910 894	" " 344, 611, 1509 and 1619	25
	8911 7284	" " 1503 and 50124	15
	19079 7278	" " 50364	10
	23535 7284	" " 346	20
	25200 7284	" " 340	10
	43184 7284	" " 1606	50

BOBBIN WINDERS

BOBBIN WINDER

(Swinging automatic, left hand)

NO.	PLATE	NAME	EACH
41894	6781	Base with 449c	\$ 50
	894D 7275	" Screw	05
41895	7270	Bobbin Carrier Key	01
41896	6782	Frame	35
41441	6782	" Hinge Pin	10
	449c 7275	" " " Set Screw	02
	4784 7270	" Oil Pad	01
41897	6782	" Spring	05
43176	6782	Pulley (leather)	75

BOBBIN WINDERS

NO.	PLATE	NAME	EACH
43177	6782	Pulley Flange with two 448c.....	\$ 35
448c	7263	" " Set Screw	03
131D	7275	" Screw	04
43178	6782	" Washer	50
41898	6781	Spindle with 41895	25
41557	6781	Stop Latch	15
41446	6781	" " Hinge Pin	10
2269	7250	" " Pin	01
41899	6782	Tripping Arm with 176D	20
176D	7275	" " Clamping Screw	03
41900	6781	Bobbin Winder, Nos. 2269, 41441, 41446, 41557, 41894, 41896 to 41899, 43176 to 43178, two 4784 and three 131D	3 45
41901	7252	Bracket for 41903	75
41902	7252	" " 41904	75
523D	7276	" Screw	15

THREAD UNWINDER PARTS

27555	7285	Spool Pin	08
27583	7285	" Rest	20
27556	—	" " 27583 with 138B and two 27555	40
138B	7275	Spool Rest Set Screw	05
27557	7285	" Stand with 138B	25
41514	7285	" Weight, 4 in. diam., with 41515	15
41515	7250	" " Centre Pin	05
2102	7270	Tension Disc	05
1560c	7270	" Regulating Thumb Nut	04
637c	7270	" Screw Stud	08
2103	7270	" Spring	03
5769	7270	" Thread Eyelet	03
41452	7285	Thread Guard	40
27560	7285	" " Rod, 26 in. long	30
138B	7275	" " " Set Screw	05
330D	7275	" " " Set Screw	02
41453	—	Thread Guard complete, Nos. 330D, 637c, 1560c, 2103, 5769, 41452 and two 2102	70
41823	7285	Thread Unwinder complete, for two large spools, Nos. 27556, 27557, 27560, 41453, two 41514 and three wood screws 1½ in. No. 12	1 95

THREAD UNWINDER PARTS

NO.	PLATE	NAME	EACH
41903	—	Bobbin Winder (swinging automatic, left hand) complete for 6-1, 6-3, 6-5 and 6-7 Machines, Nos. 523D, 41823, 41900, 41901 and three 894D	\$6 45
41904	—	Bobbin Winder (swinging automatic, left hand) complete for 6-2, 6-4, 6-6 and 6-8 Machines, Nos. 523D, 41823, 41900, 41902 and three 894D	6 45

BOBBIN WINDER (Automatic)

For 11910

(Obsolete)

NO.	PLATE	NAME	EACH
9062	607	Stand with 178F	\$ 25
9063	607	" Shaft	04
9064	6053	" " Collar	03
9065	607	" " Pulley	25
178F	6053	" " Set Screw	03
9066	607	Spindle	10
9067	607	" Frame	15
9068	607	" " Spring	10
7958	6053	" " " Pin	01
2448	607	" Pulley	15
9069	607	Stop Latch	15
9070	607	" " Bracket with 178F	20
178F	6053	" " " Set Screw	03
24D	6053	" " Hinge Screw	08
1541E	6053	Tension Regulating Thumb Nut	05
470E	6053	" Spool Pin with fixed cone..	25
8018	6053	" " " Adjustable Cone ..	05
8019	6053	" " " Spring	02
9071	—	Tension Spool Pin complete, Nos. 470E, 1541E, 8018 and 8019	25
9074	607	Tension Thread Guide Pin	03
9061	607	Bobbin Winder (automatic) com- plete, Nos. 24D, 2448, 7958, 9062 to 9071, 9074 and two wood screws 1 in. No. 7	1 50

BOBBIN WINDER (Hand)
FOR MACHINE BED
(Obsolete)

NO.	PLATE	NAME	EACH
11756	—	Belt with 25028	\$ 05
25028	7270	" Hook	01
11758	6054	Frame	50
11759	6054	Pulley	25
11760	6054	" Driving Wheel	50
8380	6054	" " " Handle (wood)	03
11762	6054	" " " " Stud	10
8382	7270	" " " " Washer	01
11761	—	Pulley Driving Wheel Handle complete, Nos. 8380, 8382 and 11762	10
11763	6054	Pulley Driving Wheel Stud	10
2269	7250	" " " " Pin	01
11764	7270	" " " " Washer	01
11765	6054	Sptndle	40
11754	7252	Bobbin Winder complete, Nos. 2269, 11756, 11758 to 11761 and 11763 to 11765	2 00
135D	7275	Bobbin Winder Screw	05

FOOT LIFTER PARTS

For Machines Nos. 6-5 to 6-8

NO.	PLATE	NAME	EACH
13351	—	Chain, 46 in. to 55 in. long	\$ 30
Note: When ordering No. 13351 give length required.			
4879	7273	Chain Connecting Link for 4885	03
11023	7279	Lifting Collar with 453c	25
2049	"	" Pin	01
453c	7263	" " Set Screw	02
64009	7258	" Lever	2 25
8055	7286	" " Hinge Pin	03
19520	7262	" " Spring	15
32D	7275	" " " Screw	10
4881	7252	Treadle	30
4882	7273	" Shaft	05
4883	7273	" Spring	10
4884	7252	" Stand	25

FOOT LIFTER PARTS

41

NO.	PLATE	NAME	EACH
4885	7252	Treadle complete, Nos. 4879, 4881 to 4884 and two wood screws 1 in. No. 16	\$ 75
64010	—	Foot Lifter complete, Nos. 31D, 2049, 4885, 8055, 11023, 13351, 19520 and 64009	3 55

IRON WORK FOR 5271

For Machine No. 6-4 with S. D. A.

NO.	PLATE	NAME	EACH
27279	—	Brace (table)	\$ 20
27006	7287	" " 27279 with 499E and two each 12620 and wood screws 1½ in. No. 14	30
499E	7288	Brace Bolt with 1522E	05
1522E	7275	" " Nut	02
12620	7288	" " " Washer	02
27032	7287	Leg, 22 in. wide	1 10
494E	7288	" Foot Screw	05
12620	7288	" " " Washer	02
27150	7287	Rail, 30 in., single flat, with two 492E, four each 12620, wood screws 1 in. No. 10 and six wood screws 1½ in. No. 14	55
492E	7288	Rail Bolt with 1522E	06
1522E	7275	" " Nut	02
12620	7288	" " " Washer	02
27244	—	Iron Work complete, Nos. two each 27006, 27032, 27150 and eight each 494E and 12620	4 50

OBSOLETE PARTS

NO.	PLATE	NAME	EACH
8922	7289	Arm Shaft for 6-1, 6-3, 6-5 and 6-7 Machines	\$8 50
9059	7289	Arm Shaft for 6-2, 6-4, 6-6 and 6-8 Machines	8 50
8923	7290	Arm Shaft Bushing	1 00
8709	7287	Balance Wheel and Pulley (tight) with two 344c, for 6-1, 6-3, 6-5 and 6-7 Machines	5 00

OBSOLETE PARTS

NO.	PLATE	NAME	EACH
*8925	—	Bed	\$30 00
8806	7287	Belt Shifter Guide Rod	30
8807	7287	" " Sliding Rod	75
3012	7250	" " " " Pin	01
8809	7291	" " " " Spring	15
8808	7286	" " " " Collar with two 448c	25
448c	7263	Belt Shifter Sliding Rod Spring Col- lar Set Screw	03
8802	—	Belt Shifter complete for 6-1, 6-3, 6-5 and 6-7 Machines, Nos. 8803, 8805 to 8807 and two each 3012 and 8808	5 00
9072	—	Bobbin Winder Tension Spool Cone for 9061, use 8018	05
9073	—	Bobbin Winder Tension Spool Cone Spring for 9061, use 8019	02
8926	7289	Crank Connecting Rod with 9141 and two 129E	1 75
129E	7275	Crank Connecting Rod Cap Screw ...	04
8990	7287	Driving Attachment Lever Bracket	1 00
150D	7286	" " " " " Screw	10
11864	7287	Driving Attachment Shaft Driving Pulley, 10 in. diam., 1½ in. face, 1¾ in. bore (sectional) with two 597c	1 30
9075	7287	Driving Attachment Treadle for 9076	30
2875	7287	" " " " 12186	50
2876	7258	" " " Pitman Rod (lower) for 27515	05
9078	—	Driving Attachment Treadle Pitman Rod for 9077, use 27639	05
27515	7258	Driving Attachment Treadle Pitman complete for 9076 and 27516, Nos. 2876, 9079 and 27639	22
9077	—	Driving Attachment Treadle Pitman complete for 9076, Nos. 9079 and two 27639, use 27515	22
9080	7291	Driving Attachment Treadle Slide with 138E, for 9076	08
138E	7275	Driving Attachment Treadle Slide Screw	05
9081	7287	Driving Attachment Treadle Stand for 9076	15
12186	—	Driving Attachment Treadle complete for 27516, Nos. 2875, 2878, 9082 and four wood screws 1 in. No. 16 ..	70

OBSOLETE PARTS

NO.	PLATE	NAME	EACH
9076	—	Driving Attachment Treadle complete for 8981, Nos. 9075, 9080 to 9082, 27515 and four wood screws 1 in. No. 16, use 27516	\$ 75
27516	—	Driving Attachment Treadle and Pit- man complete for 8981, Nos. 12186 and 27515	65
8981	—	Singer Driving Attachment complete for 6-2, 6-4, 6-6 and 6-8 Machines, Nos. 9D, 150D, 8982 to 8985, 8987, 8988, 8990 to 8992, 11864, 27516, two 497E and four 401E	12 00
254D	7274	Feed Regulator Thumb Screw	40
8944	7257	" Wheel Frame Shaft for 6-1, 6-2, 6-5 and 6-6 Machines	50
257E	7275	Needle Bar Screw Bushing	20
8748	7286	Needle Clamp with 149r, 8749 and 8750	1 00
8750	7286	Needle Clamp Thread Eyelet for 8748	08
8954	7264	Oscillating Rock Shaft with two each 8980 and 8989, for 6-3, 6-4, 6-7 and 6-8 Machines	7 50
8955	7264	Oscillating Rock Shaft with two each 8980 and 8989, for 294, for 6-1, 6-2, 6-5 and 6-6 Machines	5 50
9204	7264	Oscillating Rock Shaft with 9090 and two each 8980 and 8989, for 6-3, 6-4, 6-7 and 6-8 Machines	7 50
9090	7292	Oscillating Rock Shaft Cam for 9204	50
8752	7290	" " " Hinge Pin for 8954	1 25
294c	7276	Oscillating Rock Shaft Screw Centre for 8955	18
1503E	7275	Oscillating Rock Shaft Screw Centre Nut	10
8980	7292	Oscillating Rock Shaft Steel Plate for 8954, 8955 and 9204	15
8989	7292	Oscillating Rock Shaft Steel Plate Rivet for 8954, 8955 and 9204	01
8956	7258	Oscillating Shaft	2 00
8957	7264	" " Crank with 445c and 1803	1 00
1803	7271	Oscillating Shaft Crank Roller and Stud	45
8766	7291	Presser Bar Guide Bracket with 159D	75
8767	7266	" " " " Guide ...	50

NO.	PLATE	NAME	EACH
.166D	7275	Presser Bar Guide Bracket Set Screw	\$ 07
8759	7290	" " Lifter with 8761	1 25
257E	7275	" " Screw Bushing	20
609D	7274	" " Spring Regulating Thumb Screw	45
572E	7261	Pressure Regulating Thumb Screw	50
8959	—	Shuttle Bobbin for 8958, use 11910	25
*8960	3574	" Cylinder for 8958	1 50
11852	833	" " " 11851 and 19871	1 50
8962	3574	" " Latch Spring for 8958	15
11854	3574	" " " " " 11851	03
590E	3574	" " " " " Screw for 8958 and 11851	02
8963	3574	Shuttle Frame for 8958	1 75
19870	3555	" " with 19869, for 19871	1 75
11855	3574	" " for 11851, use 19870	1 75
8964	833	" Tension Spring for 8958, 11851 and 19871	40
8958	—	Shuttle (cylinder) 3 in. diam., complete, Nos. 590E, 773H, 8960 to 8964 and 11910, use 11851	4 00
11851	833	Shuttle (cylinder) 3 in. diam., complete, Nos. 590E, 773H, 8961, 8964, 11852 to 11855, 11910 and 12002, use 19871	4 00
19871	3555	Shuttle (cylinder) 3 in. diam., complete, Nos. 773H, 8961, 8964, 11852, 11853, 11910, 12002 and 19870, use 19980	4 00
8793	7292	Thread Eyelet (front of arm)	05
11425	7292	" " (side of arm)	05
8798	7286	" Take-up Spring	08
9087	7292	" " " "	08
8799	7260	" " " Regulator	15

FOR MACHINES NOS. 6-1 AND 6-2

NO.	PLATE	NAME	EACH
8936	7285	Feed Clutch	\$ 75
8937	7286	" " Pin	02
8938	7266	" Driver	75
8939	7286	" " Guide Bracket	25
158D	7286	" " " " Screw	08
8940	7266	" " Link	75
304C	7276	" " " Screw Centre (left)	06

NO.	PLATE	NAME	EACH
1513J	7263	Feed Driver Link Screw Centre (left) Nut	\$ 05
300C	7261	Feed Driver Link Screw Centre (right)	08
1513J	7263	Feed Driver Link Screw Centre (right) Nut	05
125D	7286	Feed Driver Link Screw Stud	12
8941	7271	" " Spring	10
8942	7286	" " " Hook for 8925	10
76D	7286	" " " Screw for 8938	06
8928	7290	" Eccentric with two 432C	1 00
432C	7275	" " Set Screw	04
8931	7289	" Rock Shaft	1 75
1015C	7276	" " " Screw Centre (left)	15
1503E	7275	" " " " " " Nut	10
294C	7276	Feed Rock Shaft Screw Centre (right)	18
1503E	7275	Feed Rock Shaft Screw Centre (right) Nut	10
9085	7289	Feed Wheel for 8932	4 00
8932	—	Feed Wheel (clutch) complete, Nos. 76D, 8933, 8934, 8936 to 8938, 8941, 8943, 8945, 8946, 9085, two each 129E, 158D, 162D, 8939 and 8947	12 00
8979	7264	Oscillating Shaft Crank with 445C and 1803, for 8969	1 00
8970	7293	Shuttle Bobbin	25
*8971	—	" Body with 742E, 8976 and 9320	4 00
*8972	—	" Cover	2 75
8973	7293	" " Hinge Pin	05
8974	7293	" Delivery Eye Thread Guard	05
8975	7293	" " " " " Rivet	01
8976	7293	Shuttle Main Spring	75
742E	7293	" " " Screw	05
9320	7293	" " " Steady Pin	per 100
459C	7293	Shuttle Tension Regulating Screw	04
8977	7293	" " Spring	20
335D	7293	" " " Screw	02
9200	7293	" " " Steady Pin	01
8969	7293	Shuttle (box) complete, Nos. 335D, 459C, 8970 to 8975, 8977 and 9200	8 00
8978	7266	Shuttle Driver with two 445C, for 8969	1 50
9205	7294	Throat Plate for 9085	1 00

FOR MACHINES NOS. 6-3 AND 6-4

NO.	PLATE	NAME	EACH
8993	7291	Feed Bar	\$2 00
8997	7289	" Lifting Rock Shaft for 8996	2 00
9093	7251	" " " " " 9095	2 00
9095	—	Feed Lifting Rock Shaft complete, Nos. 9093 and 9094	3 00
8996	—	Feed Lifting Rock Shaft complete, Nos. 8997 and 8998, use 9095	3 00
8998	7264	Feed Lifting Rock Shaft Crank with 1828 and two 445c, for 8996	1 00
9094	7264	Feed Lifting Rock Shaft Crank with 1619E, 1925 and two 445c, for 9095	1 00
1828	7271	Feed Lifting Rock Shaft Crank Roller with 372c, for 8998	25
372c	7271	Feed Lifting Rock Shaft Crank Roller Screw for 1828	12
445c	7275	Feed Lifting Rock Shaft Crank Set Screw	03
9000	—	Feed Rock Shaft complete, Nos. 9001 and 9002	2 50
9002	7281	Feed Rock Shaft Crank with two 445c	75
8999	7292	Feed Rock Shaft Crank Pin	05
445c	7275	" " " " Set Screw ..	03
9003	7295	Throat Plate for 8995	1 00

FOR MACHINES NOS. 6-1 TO 6-4

NO.	PLATE	NAME	EACH
*8921	—	Arm	\$30 00
496E	7274	" Screw	15
*8924	—	" Side Plate	1 00
134D	7275	" " " Screw	05
8747	7286	Needle Bar Connecting Stud with 129D and 437c	2 00
437c	7275	Needle Bar Connecting Stud Set Screw	04
8948	7258	Oil Cup	1 05
9083	—	" " Cover, use 11917	25
8950	—	" " Latch Spring, use 2205	04
8951	7271	" " Thread Eyelet	03
8952	—	" or Wax Stripper Washer (steel) for 8948, use 8482	03
8949	7258	Oil Cup complete, Nos. 2205, 8482, 8948, 8951, 8953, 9084, 11917 and two 207F	1 25

NO.	PLATE	NAME	EACH
8758	7265	Presser Bar	\$1 25
8762	7290	" " Lifting Link	50
	65D 7275	" " " " Cap Screw..	12
8792	7267	" " Spring	15
	609D 7274	" " " Regulating Thumb Screw	45
8768	5998	Presser Foot with 362D	1 00
	362D 7275	" " Clamping Screw	05
8772	6037	Roller Arm Bracket with 362D	3 50
	362D 7275	" " " Set Screw	05
8769	6037	Roller Presser complete, 2½ in. roller, Nos. 327D, 423F, 1520E, 1992, 8771 to 8773 and two each 307F and 1513J	10 00
8966	7290	Shuttle Race Ring	80
8967	7290	" " Slide	50
8801	7260	Thread Take-up Staple	20

FOR MACHINES NOS. 6-5 AND 6-6

NO.	PLATE	NAME	EACH
8929	7256	Feed Forked Connection	\$2 00
9016	—	Feed Rock Shaft complete, Nos. 9017 and 9055	2 50
9055	7267	Feed Rock Shaft Crank with two 445c	75
9018	—	" " " " " " " " use 9055	75
8999	7292	Feed Rock Shaft Crank Pin	05
	445c 7275	" " " " Set Screw...	03
9086	7258	" Wheel for 9015	4 00
9015	—	" " 9086 with 9014 and five 145E	10 20
9019	—	Feed (wheel) complete, Nos. 8055, 8933, 8934, 8943, 8945, 8946, 9015, 9213, two each 129E, 162D and 8947	17 60
8943	7257	Feed Wheel Frame with 445c and 2269	5 00
8055	7286	" " " Shaft Pin	03
9008	7266	Ratchet Pawl	2 00
9009	—	" " Spring, use 8734	08
9011	7286	" " Stud	25
9012	7286	" " " Pin	01
9013	7286	" " " Washer	03
64011	7294	Throat Plate for 9086	1 00

FOR MACHINES NOS. 6-7 AND 6-8

NO.	PLATE	NAME	EACH
9048	—	Feed Cam with two 432c, use 8994 ..	\$1 00
9049	7296	" Dog	1 25
9058	7252	" Forked Connection	2 00
9051	7289	" Lifting Rock Shaft for 9050	2 00
9093	7251	" " " " " 9097	2 00
9050	—	Feed Lifting Rock Shaft complete, Nos. 9051 and 9052	3 10
9097	—	Feed Lifting Rock Shaft complete, Nos. 9093 and 9096	3 10
9096	7255	Feed Lifting Rock Shaft Crank with 1619E, 1926 and two 445c, for 9097	1 10
9052	7264	Feed Lifting Rock Shaft Crank with 1866 and two 445c, for 9050	1 10
8999	7292	Feed Lifting Rock Shaft Crank Pin ..	05
1866	7271	" " " " " Roller with 372c, for 9052	35
372c	7271	Feed Lifting Rock Shaft Crank Roller Screw for 1866	12
445c	7275	Feed Lifting Rock Shaft Crank Set Screw for 9052 and 9096	03
9053	—	Feed Rock Shaft complete, Nos. 9054 and 9055	4 00
9055	7267	Feed Rock Shaft Crank with two 445c ..	75
8873	7250	" " " " Pin	05
9056	—	" " " " " use 8873 ..	15
445c	7275	" " " " Set Screw ..	03
9036	7296	Throat Plate for 9049	1 00

FOR MACHINES NOS. 6-5 TO 6-8

NO.	PLATE	NAME	EACH
*9004	—	Arm	\$35 00
496E	7274	" Screw	15
*9005	—	" Side Plate	1 25
134D	7275	" " " Screw	05
*9006	—	Bed	35 00
11027	7289	Foot Lifter Lever	1 50
11028	7266	" " " Bracket	60
2117	7250	" " " " Dowel Pin ..	01
135D	7275	" " " " Screw	05
11029	7292	" " " Hinge Pin	02
9092	—	" " " Spring, use 19520 ..	15
11092	—	Foot Lifter complete, Nos. 32D, 135D, 2049, 2117, 4885, 11023, 11027 to 11029, 13351 and 19520	3 45

NO.	PLATE	NAME	EACH
9020	7265	Lifting Presser Bar	\$1 25
9021	7273	" " " Spring	25
9156	7292	" " " " Bracket with 363c	1 50
9022	—	Lifting Presser Bar Spring Bracket with 362c, use 9156	1 25
362c	7275	Lifting Presser Bar Spring Bracket Set Screw for 9022	05
363c	7286	Lifting Presser Bar Spring Bracket Set Screw for 9156	05
2049	7261	Lifting Presser Bar Spring Stop Pin ..	01
9024	7292	" " Foot with 362D	1 50
362D	7275	" " " Screw	05
8745	7259	Needle Bar	1 50
9057	7260	" " Connecting Stud with two 437c	2 00
437c	7275	Needle Bar Connecting Stud Set Screw	04
9027	7291	Needle Bar Extension Bracket	1 00
3012	7250	" " " " Dowel Pin	01
123E	7276	Needle Bar Extension Bracket Screw ..	06
9028	7265	Presser Bar	1 25
9032	—	" " Lifting Bell Crank Toe Piece Steady Pin for 9029, use 2117 ..	05
9033	7291	Presser Bar Lifting Link	75
9034	7289	" " Spring (flat)	1 00
8968	7267	Thread Take-up Lever with 1513J and 1883	2 00
9037	7291	Vibrating Presser Bar with 9040 and two 9291	2 00
9038	—	Vibrating Presser Bar complete, Nos. 598D, 9037, 9045 and 9046	3 00
9039	7291	Vibrating Presser Bar Guide	1 25
9133	7291	" " " " with 9042 ..	1 25
9042	7254	" " " Spring Hook ..	01
9043	7254	" " " Washer	10
9044	—	" " " " Pin, use 2049	02
9045	7292	Vibrating Presser Foot	1 00
9046	7271	" " " Pin	05

NUMERICAL LIST OF PARTS
FOR
MACHINES Nos. 6-1 to 6-8

NUMERICAL LIST OF PARTS

NO.	PLATE	NAME	EACH
9D	7276	Driving Attachment Brake Block Screw for 8981 and 9198	\$ 20
10D	7274	Belt Shifter Chain Pulley Screw for 9139	25
10D	7274	Thread Take-up Lever Hinge Screw	25
16D	7274	Presser Bar Lifter Hinge Screw ...	20
17E	7276	Feed Regulator Hinge Screw	20
24D	6053	Bobbin Winder Stop Latch Hinge Screw for 9061, obsolete	08
32D	7275	Foot Lifter Lifting Lever Spring Screw for 11092 and 64010	10
32D	7275	Shuttle Race Back Spring Screw for 9100	10
65D	7275	Arm Side Cover Hinge Screw	12
65D	7275	Presser Bar Lifting Link Cap Screw for 6-5 to 6-8 Machines and obso- lete for 6-1 to 6-4 Machines	12
76D	7286	Feed Driver Spring Screw for 8938 for 8932, obsolete	06
123E	7276	Needle Bar Extension Bracket Screw for 6-5 to 6-8 Machines, obsolete	06
123E	7276	Shuttle Race Body Clamping Screw for 6-1, 6-2, 6-5 and 6-6 Machines	06
123E	7276	Shuttle Race Frame Clamping Screw for 6-3, 6-4, 6-7 and 6-8 Machines	06
125D	7286	Feed Driver Link Screw Stud for 6-1 and 6-2 Machines, obsolete	12
129E	7275	Crank Connecting Rod Cap Screw for 8926, obsolete	04
129E	7275	Feed Wheel Friction Block Spring Screw for 6-1, 6-2, 6-5 and 6-6 Ma- chines and for 8932 and 9019	04
129D	7275	Needle Bar Connecting Stud Clamp- ing Screw for 8747 and 16987 ...	04
129C	7275	Presser Bar Lifting Bell Crank Toe Piece Screw for 9029	04
131D	7275	Bobbin Winder Pulley Screw for 41900	04
134D	7275	Arm Side Plate Screw, obsolete ...	05
134D	7275	Driving Attachment Lever Screw for 9198	05

NO.	PLATE	NAME	EACH
134D	7275	Feed Lifting Rock Shaft Wearing Block Screw for 9225 and 64014	\$ 05
134D	7275	Oil Cup Screw for 6-1 to 6-4 Machines	05
134D	7275	Shuttle Race Screw for 6-3, 6-4, 6-7 and 6-8 Machines	05
134D	7275	Vibrating Presser Bar Cap and Tension Bracket Screw for 6-5 to 6-8 Machines	05
135D	7275	Bobbin Winder Screw for 11754, obsolete	05
135D	7275	Foot Lifter Lever Bracket Screw for 11092, obsolete	05
135D	7275	Presser Bar Guide Bracket Guide Screw	05
138B	7275	Bobbin Winder Thread Unwinder Spool Rest Set Screw for 27556..	05
138B	7275	Bobbin Winder Thread Unwinder Thread Guard Rod Set Screw for 27557	05
138E	7275	Driving Attachment Treadle Slide Screw for 9080, obsolete	05
145D	7275	Presser Bar Guide Bracket Adjusting Screw for 16995	04
145E	7275	Ratchet Wheel Screw for 9015, 9212 and 9236	04
149F	7260	Needle Clamp Screw for 8748, 9060 and 16988	06
150D	7286	Driving Attachment Lever Bracket Screw for 8981, obsolete	10
158D	7286	Feed Driver Guide Bracket Screw for 8932, obsolete	03
159D	7279	Presser Bar Guide Bracket Adjusting Screw for 8766 and 9035	03
162D	7254	Feed Wheel Friction Plate Screw for 6-1, 6-2, 6-5 and 6-6 Machines and for 8932 and 9019	04
164D	7275	Shuttle Race Ring Screw for 9143	04
164D	7275	Thread Guard (front of arm) Screw for 6-1 to 6-4 Machines	04
164D	7275	Thread Take-up Spring Regulator Screw	04
166D	7275	Feed Dog Screw for 6-3, 6-4, 6-7 and 6-8 Machines	07
166D	7275	Presser Bar Guide Bracket Set Screw, obsolete	07

NO.	PLATE	NAME	EACH
166D	7275	Presser Bar Lifting Link Cap Screw for 6-1 to 6-4 Machines	\$ 07
176D	7275	Bobbin Winder Tripping Arm Clamping Screw for 41899	03
178F	6053	Bobbin Winder Stand Shaft Set Screw for 9062, obsolete	03
178F	6053	Bobbin Winder Stop Latch Bracket Set Screw for 9070, obsolete	03
190D	7263	Oscillating Shaft Crank Slide Block Cap Screw for 9120	03
207F	7260	Oil Cup Cover Latch Spring Screw for 8949 and 16990	02
207F	7260	Oil or Wax Stripper Washer Screw for 8949 and 16990	02
225F	7275	Throat Plate Needle Plate Screw for 9221, 9230, 64004 and 64018	03
254D	7274	Feed Regulator Thumb Screw, obsolete	40
254D	7274	Guide Thumb Screw	40
257E	7275	Needle Bar Screw Bushing, obsolete	20
257E	7275	Presser Bar Screw Bushing, obsolete	20
294C	7276	Feed Lifting Rock Shaft Screw Centre (right) for 6-3, 6-4, 6-7 and 6-8 Machines	18
294C	7276	Feed Rock Shaft Screw Centre for 6-1 and 6-2 Machines	18
294C	7276	Feed Rock Shaft Screw Centre (right) for 6-3 to 6-6 Machines and obsolete for 6-1 and 6-2 Machines	18
294C	7276	Feed Wheel Frame Shaft Screw Centre (right) for 6-1, 6-2, 6-5 and 6-6 Machines	18
294C	7276	Oscillating Rock Shaft Screw Centre for 8955, obsolete	18
300C	7261	Feed Driver Link Screw Centre (right) for 6-1 and 6-2 Machines, obsolete	08
304C	7276	Feed Bar Screw Centre for 6-3, 6-4, 6-7 and 6-8 Machines	06
304C	7276	Feed Driver Link Screw Centre (left) for 6-1 and 6-2 Machines, obsolete	06
307F	6001	Roller Arm Screw Centre for 8769 and 43233	06
327D	6001	Roller Arm Lock Spring Screw for 8769 and 43233	05

NO.	PLATE	NAME	EACH
330D	7275	Bobbin Winder Thread Unwinder Thread Guard Set Screw for 41453	\$ 02
335D	7293	Shuttle Tension Spring Screw for 8969, obsolete	02
340D	7279	Pressure Regulating Screw for 6-5 to 6-8 Machines	06
344c	7276	Balance Wheel and Pulley (tight) Set Screw for 8709 and 61504	08
344c	7276	Balance Wheel Set Screw for 8982	08
346D	6001	Presser Foot Clamping Screw for 16999	08
346D	6001	Roller Arm Eracket Clamping Screw for 43232	08
354c	7275	Driving Attachment Treadle Pitman Rod Clamp Screw for 9079	06
362F	7275	Driving Attachment Treadle Stop Collar Set Screw for 2762	05
362c	7275	Lifting Presser Bar Spring Bracket Set Screw for 9022, obsolete	05
362D	7275	Lifting Presser Foot Screw for 9024, obsolete	05
362D	7275	Presser Foot Clamping Screw for 8768, obsolete	05
362D	7275	Roller Arm Bracket Set Screw for 8772, obsolete	05
363c	7286	Lifting Presser Bar Spring Bracket Set Screw for 9156, obsolete	05
368c	7279	Presser Bar Lifting Bell Crank Hinge Screw for 6-5 to 6-8 Machines	25
369c	7276	Crank Connecting Rod Hinge Screw	20
369c	7276	Feed Connecting Link Hinge Screw for 9234 for 6-5 and 6-6 Machines and for 64013 for 6-7 and 6-8 Machines	20
369c	7276	Feed Forked Connection Hinge Screw	20
370c	7276	Needle Bar Connecting Link Hinge Screw	18
370F	6001	Roller Screw for 1992	18
372c	7271	Feed Lifting Rock Shaft Crank Roller Screw for 1828 and 1866, obsolete	12
381D	7275	Presser Bar Spring Guide Pin Bracket Screw for 6-5 to 6-8 Machines	06
381D	7275	Pressure Regulating Screw Bracket Screw for 6-5 to 6-8 Machines	06
381D	7275	Throat Plate Screw	06

NO.	PLATE	NAME	EACH
401E	7275	Driving Attachment Friction Washer Screw for 8981 and 9198	\$ 02
406E	7270	Tension Screw Stud for 8785	25
423F	6001	Roller Arm Adjusting Screw for 8769 and 43233	05
429c	7254	Feed Wheel Frame Supporting and Regulating Screw for 6-1, 6-2, 6-5 and 6-6 Machines	05
432c	7275	Belt Shifter Fork Set Screw for 8803	04
432c	7275	Feed Cam Set Screw for 8994 and 9048	04
432c	7275	Feed Eccentric Set Screw for 8928, obsolete	04
432c	7275	Thread Take-up Cam Set Screw for 8796	04
434c	7275	Arm Shaft Bushing Set Screw	04
434c	7275	Belt Shifter Pulley (loose) Flanged Bushings Set Screw for 9135	04
437c	7275	Needle Bar Connecting Stud Set Screw for 8747 and 9057, obsolete	04
445c	7275	Feed Lifting Rock Shaft Crank Set Screw for 8998, 9052, 9094 and 9096, obsolete	03
445c	7275	Feed Rock Shaft Crank Set Screw for 9002, 9018 and 9055, obsolete	03
445c	7275	Feed Wheel Frame Set Screw for 8943 and 9237	03
445c	7275	Oscillating Shaft Crank Set Screw for 8957, 8979, 9154 and 11083	03
445c	7275	Presser Bar Guide Bracket Set Screw for 9035	03
445c	7275	Shuttle Driver Set Screw for 8965 and 8978	03
448c	7263	Belt Shifter Guide Rod Collar Set Screw for 11453	03
448c	7263	Belt Shifter Sliding Rod Spring Collar Set Screw for 8808, obsolete	03
448c	7263	Bobbin Winder Pulley Flange Set Screw for 43177	03
448c	7263	Needle Bar Bushing Set Screw for 6-1 to 6-4 Machines	03
448c	7263	Oscillating Shaft Collar Set Screw for 9152	03
448c	7263	Presser Bar Bushing Set Screw for 6-1 to 6-4 Machines	03

NUMERICAL LIST OF PARTS

NO.	PLATE	NAME	EACH
449C	7275	Bobbin Winder Frame Hinge Pin Set Screw for 41894	\$ 02
453C	7263	Foot Lifter Lifting Collar Set Screw for 11023	02
459C	7293	Shuttle Tension Regulating Screw for 8969, obsolete	04
470E	6053	Bobbin Winder Tension Spool Pin with fixed cone, for 9071, obsolete	25
492E	7288	Rail Bolt with 1522E, for 27150	06
494E	7288	Leg Foot Screw for 27244	05
496E	7274	Arm Screw, obsolete	15
497E	7274	Driving Attachment Lever Bracket Bolt with 1522E, for 8981 and 9198	05
499E	7288	Brace Bolt with 1522E, for 27006 ..	05
507E	7275	Bed Bracket Bolt with 1515E (Accessories)	02
523D	7276	Bobbin Winder Bracket Screw for 41903 and 41904	15
567D	7279	Presser Bar Spring Screw Stud for 6-5 to 6-8 Machines	15
572E	7261	Pressure Regulating Thumb Screw, obsolete	50
575E	7276	Crank Connecting Rod Cap Screw for 11054	05
590E	3574	Shuttle Cylinder Latch Spring Screw for 8958 and 11851, obsolete	02
597C	7276	Driving Attachment Shaft Driving Pulley Clamping Screw for 9091 and 11864	08
598D	7279	Vibrating Presser Foot Screw for 9038 and 64006	06
609D	7274	Presser Bar Spring Regulating Thumb Screw for 6-1 to 6-4 Machines, obsolete	45
611D	7276	Feed Lifting Rock Shaft Crank Clamping Screw for 9227 and 64016	12
637C	7270	Bobbin Winder Thread Unwinder Tension Screw Stud for 41453	08
654C	7276	Oscillating Rock Shaft Hinge Pin Screw Bearing for 9151 and 9215	25
690D	7275	Thread Take-up Staple Screw	05
742E	7293	Shuttle Main Spring Screw for 8971, obsolete	05
773H	7268	Shuttle Tension Regulating Screw for 8958, 11851, 19871 and 19980 ..	05

NUMERICAL LIST OF PARTS

NO.	PLATE	NAME	EACH
894D	7275	Bobbin Winder Base Screw for 41903 and 41904	\$ 05
961C	7261	Feed Lifting Rock Shaft Crank Roller Screw for 1925	12
962C	7276	Feed Lifting Rock Shaft Crank Roller Screw for 1926	15
965D	7271	Presser Bar Guide Bracket Clamping Screw for 16995	04
1015C	7276	Feed Lifting Rock Shaft Screw Centre (left) for 6-3, 6-4, 6-7 and 6-8 Machines	15
1015C	7276	Feed Rock Shaft Screw Centre for 6-7 and 6-8 Machines	15
1015C	7276	Feed Rock Shaft Screw Centre (left) for 6-3 to 6-6 Machines and obso- lete for 6-1 and 6-2 Machines	15
1015C	7276	Feed Wheel Frame Shaft Screw Centre (left) for 6-1, 6-2, 6-5 and 6-6 Machines	15
1016C	7263	Oscillating Shaft Crank Slide Block Screw Stud for 9120	25
1078C	7276	Feed Connecting Link Hinge Screw for 6-1 to 6-4 Machines and for 8930 for 6-5 to 6-8 Machines	20
1149C	7275	Lifting Presser Bar Guide Bracket Clamping Screw for 9240	04
1149C	7275	Lifting Presser Bar Spring Bracket Clamping Screw for 9242	04
1149C	7275	Lifting Presser Bar Stop Collar Clamping Screw for 9243	04
1149C	7275	Lifting Presser Foot Clamping Screw for 9245	04
1149E	7275	Needle Bar Connecting Stud Clamp- ing Screw for 9246	04
1177D	7275	Presser Bar Spring Bracket Screw for 6-1 to 6-4 Machines	04
1503E	7275	Feed Lifting Rock Shaft Screw Centre (left) Nut for 6-3, 6-4, 6-7 and 6-8 Machines	10
1503E	7275	Feed Lifting Rock Shaft Screw Centre (right) Nut for 6-3, 6-4, 6-7 and 6-8 Machines	10
1503E	7275	Feed Rock Shaft Screw Centre Nut for 6-1, 6-2, 6-7 and 6-8 Machines ..	10

NO.	PLATE	NAME	EACH
1503E	7275	Feed Rock Shaft Screw Centre (left) Nut for 6-3 to 6-6 Machines and obsolete for 6-1 and 6-2 Machines	\$ 10
1503E	7275	Feed Rock Shaft Screw Centre (right) Nut for 6-3 to 6-6 Machines and obsolete for 6-1 and 6-2 Machines	10
1503E	7275	Feed Wheel Frame Shaft Screw Centre (left) Nut for 6-1, 6-2, 6-5 and 6-6 Machines	10
1503E	7275	Feed Wheel Frame Shaft Screw Centre (right) Nut for 6-1, 6-2, 6-5 and 6-6 Machines	10
1503E	7275	Oscillating Rock Shaft Hinge Pin Nut for 9151 and 9215	10
1503E	7275	Oscillating Rock Shaft Hinge Pin Screw Bearing Nut for 9151 and 9215	10
1503E	7275	Oscillating Rock Shaft Screw Centre Nut, obsolete	10
1509E	7275	Crank Connecting Rod Hinge Screw Nut	06
1509E	7275	Feed Connecting Link Hinge Screw Nut	06
1509E	7275	Feed Forked Connection Hinge Screw Nut	06
1509E	7275	Needle Bar Connecting Link Hinge Screw Nut	06
1509E	6001	Roller Screw Nut for 1992	06
1509E	7275	Presser Bar Lifting Bell Crank Hinge Screw Nut for 6-5 to 6-8 Machines	06
1513J	7263	Feed Bar Screw Centre Nut for 6-3, 6-4, 6-7 and 6-8 Machines	05
1513J	7263	Feed Driver Link Screw Centre (left) Nut for 6-1 and 6-2 Machines, obsolete	05
1513J	7263	Feed Driver Link Screw Centre (right) Nut for 6-1 and 6-2 Machines, obsolete	05
1513J	7263	Oscillating Shaft Crank Slide Block Screw Stud Nut for 9154 and 11083	05
1513J	6001	Roller Arm Screw Centre Nut for 8769 and 43233	05

NO.	PLATE	NAME	EACH
1513J	7263	Thread Take-up Lever Roller and Screw Stud Nut for 8968, 9218 and 64002	\$ 05
1515E	7275	Bed Bracket Bolt Nut for 507	02
1520E	7263	Driving Attachment Lever Spring Hook Nut for 9198	03
1520E	6001	Roller Arm Adjusting Screw Nut for 8769 and 43233	03
1522E	7275	Brace Bolt Nut for 499	02
1522E	7275	Driving Attachment Lever Bracket Bolt Nut for 497	02
1522E	7275	Rail Bolt Nut for 492	02
1535E	7270	Tension Regulating Thumb Nut for 8785	10
1541E	6053	Bobbin Winder Tension Regulating Thumb Nut for 9071, obsolete ..	05
1547D	7278	Vibrating Presser Bar Cap and Tension Bracket Screw Set Screw Lock Nut for 64007	03
1560C	7270	Bobbin Winder Thread Unwinder Tension Regulating Thumb Nut for 41453	04
1606E	7275	Presser Bar Spring Regulating Screw Lock Nut for 6-1 to 6-4 Machines..	05
1608E	7254	Ratchet Ball Screw Stud Nut for 9210	05
1619E	7275	Feed Lifting Rock Shaft Crank Roller Screw Nut for 9094, 9096, 9227 and 64016	05
1803	7271	Oscillating Shaft Crank Roller and Stud for 8957 and 8979, obsolete	45
1828	7271	Feed Lifting Rock Shaft Crank Roller with 372c, for 8998, obsolete	25
1846	7279	Needle Bar Connecting Link Roller with 9026, for 9025	30
1865	7261	Thread Take-up Lever Roller and Screw Stud for 64002	45
1866	7271	Feed Lifting Rock Shaft Crank Roller with 372c, for 9052, obsolete	35
1883	7275	Thread Take-up Lever Roller and Screw Stud for 8968 and 9218 ..	35
1925	7261	Feed Lifting Rock Shaft Crank Roller with 961c, for 9094 and 9227	25
1926	7260	Feed Lifting Rock Shaft Crank Roller with 962c, for 9096 and 64016	35

NUMERICAL LIST OF PARTS

NO.	PLATE	NAME	EACH
1992	6001	Roller, 2 $\frac{1}{2}$ in. diam., with 370F and 1509E, for 8769 and 43233	\$3 00
2022	7250	Feed Lifting Rock Shaft Wearing Block Position Pin for 9225 and 64014	01
2049	7261	Foot Lifter Lifting Collar Pin for 11092 and 64010	01
2049	7261	Lifting Presser Bar Spring Stop Pin for 6-5 to 6-8 Machines, obsolete..	01
2049	7261	Ratchet Pawl Screw Stud Pin for 9210	01
2049	7261	Vibrating Presser Bar Washer Pin for 6-5 to 6-8 Machines	01
2102	7270	Bobbin Winder Thread Unwinder Tension Disc for 41453	05
2103	7270	Bobbin Winder Thread Unwinder Tension Spring for 41453	03
2117	7250	Foot Lifter Lever Bracket Dowel Pin for 11092, obsolete	01
2117	7250	Presser Bar Lifting Bell Crank Toe Piece Steady Pin for 9029	01
2205	7260	Oil Cup Cover Latch Spring for 8949 and 16990	04
2269	7250	Bobbin Winder Pulley Driving Wheel Stud Pin for 11754, obsolete	01
2269	7250	Bobbin Winder Stop Latch Pin for 41900	01
2269	7250	Feed Brake Roll Spring Hook for 8943 and 9237	01
2448	607	Bobbin Winder Spindle Pulley for 9061, obsolete	15
2762	7260	Driving Attachment Treadle Stop Collar with 362F, for 27640	10
2875	7287	Driving Attachment Treadle for 12186, obsolete	50
2876	7258	Driving Attachment Treadle Pitman Rod (lower) for 27515, obsolete ..	05
2878	7253	Driving Attachment Treadle Stand for 12186 and 27642	20
3012	7250	Belt Shifter Guide Rod Pin for 9139	01
3012	7250	" " Sliding Rod Pin for 8802, obsolete	01
3012	7250	Needle Bar Extension Bracket Dowel Pin for 6-5 to 6-8 Machines, obsolete	01

NUMERICAL LIST OF PARTS

NO.	PLATE	NAME	EACH
4389	7250	Presser Bar Spring Guide Pin for 6-1 to 6-4 Machines and for 32870 for 6-5 to 6-8 Machines	\$ 02
4784	7270	Bobbin Winder Frame Oil Pad for 41900	01
4879	7273	Chain Connecting Link for 4885 Nos. 4881 to 4884 for 4885.	03
4881	7252	Treadle	30
4882	7273	" Shaft	05
4883	7273	" Spring	10
4884	7252	" Stand	25
4885	7252	Treadle complete for 9139, 11092 and 64010, Nos. 4879, 4881 to 4884 and two wood screws 1 in. No. 16	75
5769	7270	Bobbin Winder Thread Unwinder Tension Thread Eyelet for 41453	03
5968	7263	Oscillating Shaft Crank Slide Block Cap Screw Washer for 9120	02
6055	7263	Driving Attachment Lever Spring Hook Nut Washer for 9198	01
6439	—	Belt Shifter Chain, length 36 in. to 45 in., for 9139	20
7958	6053	Bobbin Winder Spindle Frame Spring Pin for 9061, obsolete	01
8018	6053	Bobbin Winder Tension Spool Pin Adjustable Cone for 9071, obsolete	05
8019	6053	Bobbin Winder Tension Spool Pin Spring for 9071, obsolete	02
8055	7286	Feed Wheel Frame Shaft Pin for 9019, obsolete	03
8055	7286	Foot Lifter Lifting Lever Hinge Pin for 64010	03
8077	7261	Thread Take-up Spring Hook for 11066 and 43157	01
8380	6054	Bobbin Winder Pulley Driving Wheel Handle (wood) for 11761, obsolete	03
8382	7270	Bobbin Winder Pulley Driving Wheel Handle Stud Washer for 11761, obsolete	01
8482	7260	Oil or Wax Stripper Washer (steel) for 8948 for 8949 and for 16989 for 16990	01
8561	7279	Vibrating Presser Foot Pin for 64006	01
8702	7250	Arm Dowel Pin	15
8705	7253	Belt Shifter Pulley (loose) for 9139	1 50
8708	7250	Arm Spool Pin	05

NO.	PLATE	NAME	EACH
8709	7287	Balance Wheel and Pulley (tight) with two 344c, for 6-1, 6-3, 6-5 and 6-7 Machines, obsolete	\$5 00
8714	7250	Thread Take-up Cam Pin	15
8734	7270	Vibrating Presser Bar Spring for 6-5 to 6-8 Machines	08
8745	7259	Needle Bar for 6-1 to 6-4 Machines and obsolete for 6-5 and 6-8 Machines	1 50
8746	7259	Needle Bar Connecting Link for 6-1 to 6-4 Machines	1 25
8747	7286	Needle Bar Connecting Stud with 129D and 437c, for 6-1 to 6-4 Machines, obsolete	2 00
8748	7286	Needle Clamp with 149F, 8749 and 8750, obsolete	1 00
8749	7260	Needle Clamp G1b for 8748, 9060 and 16988	25
8750	7286	Needle Clamp Thread Eyelet for 8748, obsolete	08
8752	7290	Oscillating Rock Shaft Hinge Pin for 8954, obsolete	1 25
8758	7265	Presser Bar for 6-1 to 6-4 Machines, obsolete	1 25
8759	7290	Presser Bar Lifter with 8761, obsolete	1 25
8760	7250	" " " Friction Washer ..	03
8761	7250	" " " Stop Pin for 8759 and 16996	05
8762	7290	Presser Bar Lifting Link for 6-1 to 6-4 Machines, obsolete	50
8763	7250	Presser Bar Lifting Link Hinge Stud for 16996	25
8765	7250	Presser Bar Lifting Link Hinge Stud Washer	04
8766	7291	Presser Bar Guide Bracket with 159D, obsolete	75
8767	7266	Presser Bar Guide Bracket Guide, obsolete	50
8768	5998	Presser Foot with 362D, for 6-1 to 6-4 Machines, obsolete	1 00
8769	6037	Roller Presser complete, 2 $\frac{3}{8}$ in. roller, for 6-1 to 6-4 Machines, Nos. 327D, 423F, 1520E, 1992, 8771 to 8773 and two each 307F and 1513J, obsolete ..	10 00
8771	6001	Roller Arm for 8769 and 43233	3 00

NO.	PLATE	NAME	EACH
8772	6037	Roller Arm Bracket with 362D, for 8769, obsolete	\$3 50
8773	6001	Roller Arm Lock Spring for 8769 and 43233	10
8785	—	Tension complete, Nos. 406E, 1535E, 8787, 8788 and two 8786	90
8786	7270	Tension Disc for 8785	15
8787	7270	Ratchet Pawl Screw Stud Nut Washer for 9210	01
8787	7270	Tension Regulating Thumb Nut Washer for 8785	01
8788	7270	Tension Spring for 8785	25
8792	7267	Presser Bar Spring for 6-1 to 6-4 Machines, obsolete	15
8793	7292	Thread Eyelet (front of arm) obsolete ..	05
8796	7257	" Take-up Cam with two 432c ..	8 00
8798	7286	" " Spring, obsolete	08
8799	7260	" " " Regulator, obsolete ..	15
8801	7260	" " Staple for 6-1 to 6-4 Machines, obsolete	20
8802	—	Belt Shifter complete for 6-1, 6-3, 6-5 and 6-7 Machines, Nos. 8803, 8805 to 8807 and two each 3012 and 8808, obsolete	5 00
8803	7253	Belt Shifter Frame with 8804 and two 432c, for 8802 and 9139	1 75
8804	7253	Belt Shifter Frame Handle for 8803 ..	30
8805	7253	" " Fork for 8802 and 9139 ..	75
		Nos. 8806 to 8808 for 8802, obsolete ..	
8806	7287	Belt Shifter Guide Rod	30
8807	7287	" " Sliding Rod	75
8808	7286	" " " " Spring Collar with two 448c	25
8809	7291	Belt Shifter Sliding Rod Spring, obsolete	15
8873	7250	Belt Shifter Slide Rod Pin for 9139 ..	05
8873	7250	Feed Rock Shaft Crank Pin for 6-7 and 6-8 Machines, obsolete	05
8885	7254	Ratchet Pawl Spring for 6-1, 6-2, 6-5 and 6-6 Machines	15
8908	894	Wrench for 1520 and 1547 (Accessories)	08
8909	894	Wrench for 523, 1513, 1608 and 50323 (Accessories)	10
8910	894	Wrench for 344, 611, 1509 and 1619 (Accessories)	25

NUMERICAL LIST OF PARTS

NO.	PLATE	NAME	EACH
8911	7284	Wrench for 1503 and 50124 (Accessories)	\$ 15
*8921	—	Arm for 6-1 to 6-4 Machines, obsolete	30 00
8922	7289	Arm Shaft for 6-1, 6-3, 6-5 and 6-7 Machines, obsolete	8 50
8923	7290	Arm Shaft Bushing, obsolete	1 00
*8924	—	" Side Plate for 6-1 to 6-4 Machines, obsolete	1 00
*8925	—	Bed for 6-1 to 6-8 Machines, obsolete	30 00
8926	7289	Crank Connecting Rod with 9141 and two 129E, obsolete	1 75
8927	7255	Feed Connecting Link	75
8928	7290	" Eccentric with two 432c, for 6-1 and 6-2 Machines, obsolete	1 00
8929	7256	Feed Forked Connection for 6-1 to 6-4 Machines and obsolete for 6-5 and 6-6 Machines	2 00
8930	7255	Feed Regulator	75
8931	7289	" Rock Shaft for 6-1 and 6-2 Machines, obsolete	1 75
8932	—	Feed Wheel (clutch) complete for 6-1 and 6-2 Machines, Nos. 76D, 8933, 8934, 8936 to 8938, 8941, 8943, 8945, 8946, 9085, two each 129E, 158D, 162D, 8939 and 8947, obsolete ...	12 00
8933	7254	Feed Brake Roll for 6-1, 6-2, 6-5 and 6-6 Machines and for 8932 and 9019	20
8934	7254	Feed Brake Roll Spring for 6-1, 6-2, 6-5 and 6-6 Machines and for 8932 and 9019	05
8935	—	No. cancelled, order 2269.	
		Nos. 8936 to 8939 for 8932, obsolete.	
8936	7286	Feed Clutch	75
8937	7286	" " Pin	02
8938	7266	" Driver	75
8939	7286	" " Guide Bracket	25
8940	7266	" " Link for 6-1 and 6-2 Machines, obsolete	75
8941	7271	Feed Driver Spring for 8932, obsolete	10
8942	7286	" " " Hook for 8925 for 6-1 and 6-2 Machines, obsolete ...	10
8943	7257	Feed Wheel Frame with 445c and 2269, for 6-1 and 6-2 Machines and for 8932 and 9019	5 00

NUMERICAL LIST OF PARTS

NO.	PLATE	NAME	EACH
8944	7257	Feed Wheel Frame Shaft for 6-1, 6-2, 6-5 and 6-6 Machines, obsolete..	\$ 50
		Nos. 8945 to 8947 for 6-1, 6-2, 6-5 and 6-6 Machines and for 8932 and 9019.	
8945	7254	Feed Wheel Friction Block (wood)	05
8946	7254	" " " " Spring	20
8947	7254	" " " Plate	10
8948	7258	Oil Cup for 8949, obsolete	1 05
8949	7258	Oil Cup complete for 6-1 to 6-4 Machines, Nos. 2205, 8482, 8948, 8951, 8953, 9084, 11917 and two 207E, obsolete	1 25
8950	—	Oil Cup Cover Latch Spring for 8949, obsolete, use 2205	04
8951	7271	Oil Cup Thread Eyelet for 8949, obsolete	03
8952	—	Oil or Wax Stripper Washer (steel) for 8948, obsolete, use 8482	03
8953	7260	Oil or Wax Stripper (felt) for 8949 and 16990	03
8954	7264	Oscillating Rock Shaft with two each 8980 and 8989, for 6-3, 6-4, 6-7 and 6-8 Machines, obsolete	7 50
8955	7264	Oscillating Rock Shaft with two each 8980 and 8989, for 294 for 6-1, 6-2, 6-5 and 6-6 Machines, obsolete ..	5 50
8956	7258	Oscillating Shaft, obsolete	2 00
8957	7264	" " Crank with 445c and 1803, obsolete	1 00
8958	—	Shuttle (cylinder) 3 in. diam., complete, Nos. 590E, 773H, 8960 to 8964 and 11910, obsolete, use 11851	4 00
8959	—	Shuttle Bobbin for 8958, obsolete, use 11910	25
*8960	3574	Shuttle Cylinder for 8958, obsolete ..	1 50
8961	7268	" " Hinge Pin for 8958, 11851, 19871 and 19980	02
8962	3574	Shuttle Cylinder Latch Spring for 8958, obsolete	15
8963	3574	Shuttle Frame for 8958, obsolete	1 75
8964	833	" Tension Spring for 8958, 11851 and 19871, obsolete	40
8965	7259	Shuttle Driver with 445c	3 00
8966	7290	" Race Ring for 6-1 to 6-4 Machines, obsolete	80

NUMERICAL LIST OF PARTS

NO.	PLATE	NAME	EACH
8967	7290	Shuttle Race SHde for 6-1 to 6-4 Machines, obsolete	\$ 50
8968	7267	Thread Take-up Lever with 1513J and 1883, for 6-5 to 6-8 Machines, obsolete	2 00
8969	7293	Shuttle (box) complete for 6-1 and 6-2 Machines, Nos. 335D, 459C, 8970 to 8975, 8977 and 9200, obsolete	8 00
Nos. 8970 to 8972 for 8969, obsolete.			
8970	7293	Shuttle Bobbin	25
*8971	—	" Body with 742E, 8976 and 9320	4 00
*8972	—	" Cover	2 75
8973	7250	Presser Bar Lifting Link Hinge Stud Pin	05
8973	7293	Shuttle Cover Hinge Pin for 8969, obsolete	05
8974	7293	Shuttle Delivery Eye Thread Guard for 8969, obsolete	05
8975	7293	Shuttle Delivery Eye Thread Guard Rivet for 8969, obsolete	01
8976	7293	Shuttle Main Spring for 8971, obsolete	75
8977	7293	Shuttle Tension Spring for 8969, obsolete	20
8978	7266	Shuttle Driver with two 445c, for 8969, obsolete	1 50
8979	7264	Oscillating Shaft Crank with 445c and 1803, for 8969, obsolete	1 00
8980	7292	Oscillating Rock Shaft Steel Plate for 8954, 8955 and 9204, obsolete	15
8981	—	Singer Driving Attachment complete for 6-2, 6-4, 6-6 and 6-8 Machines, Nos. 9D, 150D, 8982 to 8985, 8987, 8988, 8990 to 8992, 11864, 27516, two 497E and four 401E, obsolete	12 00*
8982	7253	Balance Wheel with two 344c, for 6-2, 6-4, 6-6 and 6-8 Machines	4 00
8983	7250	Balance Wheel Pin for 6-2, 6-4, 6-6 and 6-8 Machines	10
8984	7273	Driving Attachment Brake Block (wood) for 8981 and 9198	05
8985	7253	Driving Attachment Friction Pulley with 8986, for 8981 and 9198	2 75
8986	7273	Driving Attachment Friction Pulley Centre Bearing for 8985	25

NUMERICAL LIST OF PARTS

NO.	PLATE	NAME	EACH
8987	7253	Driving Attachment Friction Washer (paper) for 8981 and 9198	\$ 10
8988	7253	Driving Attachment Lever for 8981 and 9198	1 00
8989	7292	Oscillating Rock Shaft Steel Plate Rivet for 8954, 8955 and 9204, obsolete	01
8990	7287	Driving Attachment Lever Bracket for 8981, obsolete	1 00
8991	7273	Driving Attachment Lever Screw Washer for 8981 and 9198	06
8992	7273	Driving Attachment Lever Spring for 8981 and 9198	20
8993	7291	Feed Bar for 6-3 and 6-4 Machines, obsolete	2 00
8994	7255	Feed Cam with two 432c	1 00
8995	7277	" Dog for 6-3 and 6-4 Machines ..	1 25
8996	—	Feed Lifting Rock Shaft complete for 6-3 and 6-4 Machines, Nos. 8997 and 8998, obsolete, use 9095	3 00
8997	7289	Feed Lifting Rock Shaft for 8996, obsolete	2 00
8998	7264	Feed Lifting Rock Shaft Crank with 1828 and two 445c, for 8996, obsolete	1 00
8999	7292	Feed Lifting Rock Shaft Crank Pin for 6-7 and 6-8 Machines, obsolete	05
8999	7292	Feed Rock Shaft Crank Pin for 6-3 to 6-6 Machines, obsolete	05
9000	—	Feed Rock Shaft complete for 6-3 and 6-4 Machines, Nos. 9001 and 9002, obsolete	2 50
9001	7258	Feed Rock Shaft for 9000 and 9228 ..	1 75
9002	7281	" " " Crank with two 445c, for 9000, obsolete	75
9003	7295	Throat Plate for 8995, obsolete	1 00
Nos. 9004 to 9006 for 6-5 to 6-8 Machines, obsolete.			
*9004	—	Arm	35 00
*9005	—	" Side Plate	1 25
*9006	—	Bed	35 00
9007	—	No. cancelled, order 9213.	
9008	7266	Ratchet Pawl for 6-1 and 6-2 Machines and obsolete for 6-5 and 6-6 Machines	2 00

NUMERICAL LIST OF PARTS

NO.	PLATE	NAME	EACH
9009	—	Ratchet Pawl Spring for 6-5 and 6-6 Machines, obsolete, use 8734	\$ 08
9010	7254	Ratchet Pawl Spring Hook for 9210..	01
9011	7286	" " Stud for 6-5 and 6-6 Ma- chines, obsolete	25
9012	7286	Ratchet Pawl Stud Pin for 6-5 and 6-6 Machines, obsolete	01
9013	7286	Ratchet Pawl Stud Washer for 6-5 and 6-6 Machines, obsolete	03
9013	7286	Vibrating Presser Bar Washer for 6-5 to 6-8 Machines	03
9014	7258	Ratchet Wheel for 9015 and 9236 . . .	6 00
9015	—	Feed Wheel 9086 with 9014 and five 145E, for 9019, obsolete	10 20
9016	—	Feed Rock Shaft complete for 6-5 and 6-6 Machines, Nos. 9017 and 9055, obsolete	2 50
9017	7257	Feed Rock Shaft for 9016 and 9210..	1 75
9018	—	" " " Crank with two 445c, for 6-5 and 6-6 Machines, obsolete, use 9055	75
9019	—	Feed (wheel) complete for 6-5 and 6-6 Machines, Nos. 8055, 8933, 8934, 8943, 8945, 8946, 9015, 9213, two each 129E, 162D and 8947, obsolete	17 60
		Nos. 9020 to 9022 for 6-5 to 6-8 Machines, obsolete.	
9020	7265	Lifting Presser Bar	1 25
9021	7273	" " " Spring	25
9022	—	" " " " Bracket with 362c, use 9156	1 25
9023	—	No. cancelled, order 2049.	
		Nos. 9024 to 9035 for 6-5 to 6-8 Machines.	
9024	7292	Lifting Presser Foot with 362D, obso- lete	1 50
9025	7262	Needle Bar Connecting Link with 1846	4 00
9026	7279	Needle Bar Connecting Link Roller Pin for 1846	10
9027	7291	Needle Bar Extension Bracket, obso- lete	1 00
9028	7265	Presser Bar, obsolete	1 25
9029	7262	Presser Bar Lifting Bell Crank com- plete, Nos. 129c, 2117, 9030 and 9031	5 00

NUMERICAL LIST OF PARTS

NO.	PLATE	NAME	EACH
9030	—	Presser Bar Lifting Bell Crank for 9029	\$4 00
9031	7279	Presser Bar Lifting Bell Crank Toe Piece for 9029	1 00
9032	—	Presser Bar Lifting Bell Crank Toe Piece Steady Pin for 9029, obso- lete, use 2117	05
9033	7291	Presser Bar Lifting Link, obsolete..	75
9034	7289	" " Spring (flat) obsolete..	1 00
9035	7280	" " Guide Bracket with 159D and two 445c	4 00
9036	7296	Throat Plate for 9049, obsolete	1 00
9037	7291	Vibrating Presser Bar with 9040 and two 9291, for 9038, obsolete	2 00
9038	—	Vibrating Presser Bar complete for 6-5 to 6-8 Machines, Nos. 598D, 9037, 9045 and 9046, obsolete	3 00
9039	7291	Vibrating Presser Bar Guide for 6-5 to 6-8 Machines, obsolete	1 25
9040	7280	Vibrating Presser Bar Spring Bracket with 19614, for 9037 and 64005 . . .	50
9041	—	No. cancelled, order 9291.	
9042	7254	Vibrating Presser Bar Spring Hook for 9133, obsolete	01
9043	7254	Ratchet Pawl Screw Stud Pin Washer for 9210	10
9043	7254	Vibrating Presser Bar Washer for 6-5 to 6-8 Machines, obsolete	10
9044	—	Vibrating Presser Bar Washer Pin for 6-5 to 6-8 Machines, obsolete, use 2049	02
9045	7292	Vibrating Presser Foot for 9038, obso- lete	1 00
9046	7271	Thread Take-up Spring Lever Stop Pin for 11066	05
9046	7271	Vibrating Presser Foot Pin for 9038, obsolete	05
		Nos. 9047 to 9054 for 6-7 and 6-8 Machines.	
9047	7259	Feed Bar	3 00
9048	—	" Cam with two 432c, obsolete, use 8994	1 00
9049	7296	Feed Dog, obsolete	1 25
9050	—	Feed Lifting Rock Shaft complete, Nos. 9051 and 9052, obsolete	3 10
9051	7289	Feed Lifting Rock Shaft for 9050, obsolete	2 00

NO.	PLATE	NAME	EACH
9052	7264	Feed Lifting Rock Shaft Crank with 1866 and two 445c, for 9050, obsolete	\$1 10
9053	—	Feed Rock Shaft complete, Nos. 9054 and 9055, obsolete	4 00
9054	7251	Feed Rock Shaft for 9053 and 64017	3 25
9055	7267	" " " Crank with two 445c, for 9016 and 9053, obsolete	75
9056	—	Feed Rock Shaft Crank Pin for 6-7 and 6-8 Machines, obsolete, use 8873	15
9057	7260	Needle Bar Connecting Stud with two 437c, for 6-5 to 6-8 Machines, obsolete	2 00
9058	7252	Feed Forked Connection for 6-7 and 6-8 Machines, obsolete	2 00
9059	7289	Arm Shaft for 6-2, 6-4, 6-6 and 6-8 Machines, obsolete	8 50
9060	7260	Needle Clamp with 149f and 8749, for 6-5 to 6-8 Machines	90
9061	607	Bobbin Winder (automatic) complete for 11910, Nos. 24D, 2448, 7958, 9062 to 9071, 9074 and two wood screws 1 in. No. 7, obsolete	1 50
		Nos. 9062 to 9071 for 9061, obsolete.	
9062	607	Bobbin Winder Stand with 178f	25
9063	607	" " " Shaft	04
9064	6053	" " " " Collar ..	03
9065	607	" " " " Pulley ..	25
9066	607	" " Spindle	10
9067	607	" " " Frame	15
9068	607	" " " Spring ..	10
9069	607	" " Stop Latch	15
9070	607	" " " Bracket with 178f	20
9071	—	Bobbin Winder Tension Spool Pin complete, Nos. 470E, 1541E, 8018 and 8019	25
9072	—	Bobbin Winder Tension Spool Cone for 9061, obsolete, use 8018	05
9073	—	Bobbin Winder Tension Spool Cone Spring for 9061, obsolete, use 8019	02
9074	607	Bobbin Winder Tension Thread Guide Pin for 9061, obsolete	03
9075	7287	Driving Attachment Treadle for 9076, obsolete	30

NO.	PLATE	NAME	EACH
9076	—	Driving Attachment Treadle complete for 8981, Nos. 9075, 9080 to 9082, 27515 and four wood screws 1 in. No. 16, obsolete, use 27516	\$ 75
9077	—	Driving Attachment Treadle Pitman complete for 9076, Nos. 9079 and two 27639, obsolete, use 27515 ..	22
9078	—	Driving Attachment Treadle Pitman Rod for 9077, obsolete, use 27639	05
9079	7251	Driving Attachment Treadle Pitman Rod Clamp with 354c, for 9077, 27515 and 27640	15
9080	7291	Driving Attachment Treadle Slide with 138E, for 9076, obsolete	08
9081	7287	Driving Attachment Treadle Stand for 9076, obsolete	15
9082	7250	Driving Attachment Treadle Bearing Cotter Pin for 9076, 12186 and 27642	01
9083	—	Oil Cup Cover for 8949, obsolete, use 11917	25
9084	7260	Oil Cup Cover Hinge Pin for 8949 and 16990	02
9085	7289	Feed Wheel for 8932, obsolete	4 00
9086	7258	" " " 9015 and 9212	4 00
9087	7292	Thread Take-up Spring, obsolete ...	08
9088	—	No. cancelled.	
9090	7292	Oscillating Rock Shaft Cam for 9204, obsolete	50
9091	7253	Driving Attachment Shaft Driving Pulley, 10 in. diam., 1½ in. face, 1¼ in. bore (sectional) with two 597c, for 9198	1 40
9092	—	Foot Lifter Lever Spring for 11092, obsolete, use 19520	15
9093	7251	Feed Lifting Rock Shaft for 9095 and 9097, obsolete	2 00
9094	7264	Feed Lifting Rock Shaft Crank with 1619E, 1925 and two 445c, for 9095, obsolete	1 00
9095	—	Feed Lifting Rock Shaft complete for 6-3 and 6-4 Machines, Nos. 9093 and 9094, obsolete	3 00
9096	7255	Feed Lifting Rock Shaft Crank with 1619E, 1926 and two 445c, for 9097, obsolete	1 10

NO.	PLATE	NAME	EACH
9097	—	Feed Lifting Rock Shaft complete for 6-7 and 6-8 Machines, Nos. 9093 and 9096, obsolete	\$3 10
9098	7252	Shuttle Race Body for 9100	2 75
9099	7252	" " Frame with 11838, for 6-3, 6-4, 6-7 and 6-8 Machines	2 00
9100	—	Shuttle Race (flexible back) complete for 6-3, 6-4, 6-7 and 6-8 Machines, Nos. 32D, 9098, 11832, 11834 and two 11833	4 00
9104	7273	Belt Shifter Pulley (loose) Collar for 9139	25
9105	7252	Arm Side Cover	25
9110	7267	Presser Bar Guide Bracket Guide for 6-1 to 6-4 Machines	1 00
9115	7259	Oscillating Rock Shaft Hinge Pin for 9151 and 9215	1 25
9116	7252	Oscillating Shaft	2 00
9119	7263	" " Crank Slide Block for 9120	35
9120	7263	Oscillating Shaft Crank Slide Block complete for 9154 and 11083, Nos. 190D, 1016C, 5968 and 9119	60
9121	7269	Shuttle Race Slide (right)	35
9122	7269	" " " (left) for 6-1 to 6-4 Machines	50
9124	7263	Thread Take-up Spring for 6-5 to 6-8 Machines	15
9126	7272	Throat Plate Needle Plate for 9221, 64004 and 64018	50
		Nos. 9132 to 9134 for 6-5 to 6-8 Machines.	
9132	7278	Thread Take-up Staple	20
9133	7291	Vibrating Presser Bar Guide with 9042, obsolete	1 25
9134	7265	Needle Bar	1 50
9135	7273	Belt Shifter Pulley (loose) Flanged Bushing with two 434C, for 9139 ..	1 00
9137	7273	Belt Shifter Chain Pulley for 9139 ..	35
9138	7253	" " Slide Rod for 9139	1 50
9139	—	Belt Shifter complete for 6-1, 6-3, 6-5 and 6-7 Machines, Nos. 10D, 3012, 4885, 6439, 8705, 8803, 8805, 8873, 9104, 9135, 9137, 9138, 11446, 11451, 11453, 11454 and 61504	13 50

NO.	PLATE	NAME	EACH
*9141	—	Crank Connecting Rod Cap for 8926 and 11054	\$ 75
9142	7258	Shuttle Race Body with 11838 for 9143 ..	3 00
9143	—	Shuttle Race complete for 6-1, 6-2, 6-5 and 6-6 Machines, Nos. 9142, 11417 and two 164D	4 00
9144	7251	Arm Shaft for 6-1, 6-3, 6-5 and 6-7 Machines	8 50
9150	7259	Oscillating Rock Shaft for 9151	7 50
9151	—	Oscillating Rock Shaft complete for 6-3, 6-4, 6-7, and 6-8 Machines, Nos. 654C, 9115, 9150, 11165 and two 1503E	9 25
9152	7263	Oscillating Shaft Collar with two 448C ..	30
9153	—	" " Crank for 9154	2 00
9154	7255	Oscillating Shaft Crank complete for 6-3, 6-4, 6-7 and 6-8 Machines, Nos. 445C, 1513J, 9120 and 9153	2 70
9156	7292	Lifting Presser Bar Spring Bracket with 363C, for 6-5 to 6-8 Machines, obsolete	1 50
9196	7251	Arm Shaft for 6-2, 6-4, 6-6 and 6-8 Machines	8 50
9197	7253	Driving Attachment Lever Bracket for 9198	2 00
9198	—	Driving Attachment complete for 6-2, 6-4, 6-6 and 6-8 Machines, Nos. 9D, 134D, 1520E, 6055, 8982 to 8985, 8987, 8988, 8991, 8992, 9091, 9197, 9222, 27643, two 497E and four 401E	12 50
9200	7293	Shuttle Tension Spring Steady Pin for 8969, obsolete	01
9204	7264	Oscillating Rock Shaft with 9090 and two each 8980 and 8989, for 6-3, 6-4, 6-7 and 6-8 Machines, obsolete ..	7 50
9205	7294	Throat Plate for 9085, obsolete	1 00
*9206	—	Arm for 6-1 to 6-4 Machines	35 00
9207	7250	" " Oil Tube for oiling 9150 and 11081	10
9208	7273	Arm Shaft Bushing	1 00
*9209	—	Bed for 6-1, 6-2, 6-5 and 6-6 Machines ..	35 00
9210	—	Feed Rock Shaft complete for 6-1, 6-2, 6-5 and 6-6 Machines, Nos. 1608E, 2049, 8787, 9010, 9017, 9043, 9211 and 50355E	3 10

NUMERICAL LIST OF PARTS

NO.	PLATE	NAME	EACH
9211	7255	Feed Rock Shaft Crank with 50124d, for 9210 and 64017	\$1 00
9212	—	Feed Wheel 9086 with 9217 and five 145E, for 6-1 and 6-2 Machines ..	10 20
9213	7257	Feed Wheel Frame Shaft for 6-1, 6-2, 6-5 and 6-6 Machines and for 9019	1 50
9214	7260	Needle Bar Bushing for 6-1 to 6-4 Machines	75
9214	7260	Presser Bar Bushing for 6-1 to 6-4 Machines	75
9215	—	Oscillating Rock Shaft complete for 6-1, 6-2, 6-5 and 6-6 Machines, Nos. 654c, 9115, 11081, 11165 and two 1503E	9 70
9216	7263	Oscillating Shaft Crank Pin	05
9216	7263	Shuttle Driver Pin	05
9217	7258	Ratchet Wheel for 9212	6 00
9218	7259	Thread Take-up Lever with 1513J, 1883 and 9219, for 6-1 to 6-4 Ma- chines	2 25
9219	7250	Thread Take-up Lever Thread Eyelet Bushing for 9218 and 64002	25
9220	7271	Thread Take-up Staple for 6-1 to 6-4 Machines	20
9221	7272	Throat Plate with 225F and 9126, for 9086 for 6-1 and 6-2 Machines	1 75
9222	7267	Driving Attachment Lever Spring Hook for 9198	15
*9223	—	Bed for 6-3, 6-4, 6-7 and 6-8 Machines	35 00
9224	7262	Feed Bar for 6-3 and 6-4 Machines ..	3 00
9225	7256	" Lifting Rock Shaft with 134D, 2022 and 19967, for 9226	1 75
9226	—	Feed Lifting Rock Shaft complete for 6-3 and 6-4 Machines, Nos. 9225 and 9227	4 25
9227	7264	Feed Lifting Rock Shaft Crank with 611D, 1619E and 1925, for 9226 ..	2 50
9228	—	Feed Rock Shaft complete for 6-3 and 6-4 Machines, Nos. 9001 and 9229	2 75
9229	7281	Feed Rock Shaft Crank with 50124D, for 9228	1 00
9230	7277	Throat Plate with 225F and 9231, for 8995	1 75
9231	7277	Throat Plate Needle Plate for 9230 ..	50
*9233	—	Arm for 6-5 to 6-8 Machines	35 00

NUMERICAL LIST OF PARTS

NO.	PLATE	NAME	EACH
9234	7257	Feed Forked Connection for 6-5 and 6-6 Machines	\$2 00
9235	7258	Feed Wheel for 9236	4 00
9236	—	" " 9235 with 9014 and five 145E, for 6-5 and 6-6 Machines ...	10 20
9237	7257	Feed Wheel Frame with 445c and 2269, for 6-5 and 6-6 Machines	5 00
Nos 9238 to 9249 for 6-5 to 6-8 Machines.			
9238	7257	Lifting Presser Bar	1 25
9239	7278	" " " Bushing	75
9239	7278	Needle Bar Bushing	75
9239	7278	Presser Bar Bushing	75
9240	7278	Lifting Presser Bar Guide Bracket with two 1149c	2 00
9241	7262	Lifting Presser Bar Spring	30
9242	7278	" " " " Bracket with two 1149c	2 00
9243	7278	Lifting Presser Bar Stop Collar with 1149c	50
9244	7278	Lifting Presser Bar Stop Collar Spring	10
9245	7279	" " Foot with two 1149c ..	2 00
9246	7278	Needle Bar Connecting Stud with two 1149c	3 00
9247	7265	Presser Bar	1 00
9248	7280	" " Guide Bracket Guide..	1 00
9249	7280	" " Lifting Link	1 00
9250	7262	Ratchet Pawl for 6-5 and 6-6 Machines	2 00
9291	7250	Vibrating Presser Bar Spring Bracket Rivet for 9037 and 64005	01
9320	7293	Shuttle Main Spring Steady Pin for 8971, obsolete	per 100 10
11023	7279	Foot Lifter Lifting Collar with 453c, for 11092 and 64010	25
Nos. 11027 to 11029 for 11092, obsolete.			
11027	7289	Foot Lifter Lever	1 50
11028	7266	" " " Bracket	60
11029	7292	" " " Hinge Pin	02
11031	7252	Presser Bar Spring (flat) for 6-1 to 6-4 Machines	1 50
11054	7251	Crank Connecting Rod with 9141 and two 575E	1 75
11066	7271	Thread Take-up Spring Regulator with 8077 and 9046, for 6-1 to 6-4 Machines	1 50
11081	7262	Oscillating Rock Shaft for 9215	8 00

NO.	PLATE	NAME	EACH
11083	7264	Oscillating Shaft Crank with 445c, 1513j and 9120, for 6-1, 6-2, 6-5 and 6-6 Machines	\$1 50
11092	—	Foot Lifter complete for 6-5 to 6-8 Machines, Nos. 32b, 135b, 2049, 2117, 4885, 11023, 11027 to 11029, 13351 and 19520, obsolete	3 45
11165	7263	Oscillating Rock Shaft Oil Pad for 9151 and 9215	01
11241	7263	Arm Spool Pin Washer (cloth)	25
		per 100	
11360	894	Bed Bracket (right) with wood screw 1 in. No. 16 (Accessories)	10
11361	894	Bed Bracket (left) with wood screw 1 in. No. 16 (Accessories)	10
11417	7258	Shuttle Race Ring for 9143	75
11425	7292	Thread Eyelet (side of arm) obsolete	05
11446	7250	Belt Shifter Chain Eyelet for 9139	04
11451	7253	" " Guide Rod for 9139	75
11453	7263	" " " " Collar with two 448c. for 9139	15
11454	7273	Belt Shifter Guide Rod Spring for 9139	15
11754	7252	Bobbin Winder (hand. for machine bed) complete, Nos. 2269, 11756, 11758 to 11761 and 11763 to 11765, obsolete	2 00
11756	—	Bobbin Winder Belt with 25028, for 11754, obsolete	05
		Nos. 11758 to 11761 for 11754, obsolete.	
11758	6054	Bobbin Winder Frame	50
11759	6054	" " Pulley	25
11760	6054	" " " Driving Wheel	50
11761	—	Bobbin Winder Pulley Driving Wheel Handle complete, Nos. 8380, 8382 and 11762	10
11762	6054	Bobbin Winder Pulley Driving Wheel Handle Stud for 11761, obsolete	10
		Nos. 11763 to 11765 for 11754, obsolete.	
11763	6054	Bobbin Winder Pulley Driving Wheel Stud	10
11764	7270	Bobbin Winder Pulley Driving Wheel Stud Washer	01
11765	6054	Bobbin Winder Spindle	40

NO.	PLATE	NAME	EACH
11831	6047	Screw Driver, large (Accessories) ..	\$ 20
		Nos. 11832 to 11834 for 9100.	
11832	7255	Shuttle Race Back	1 00
11833	7250	" " " Position Pin	01
11834	7255	" " " Spring	25
11838	7250	" " Body Position Pin for 9142	03
11838	7250	Shuttle Race Frame Position Pin for 9099	03
11851	833	Shuttle (cylinder) 3 in. diam., complete, Nos. 590E, 773D, 8961, 8964, 11852 to 11855, 11910 and 12002, obsolete, use 19871	4 00
11852	833	Shuttle Cylinder for 11851 and 19871, obsolete	1 50
11853	7268	Shuttle Cylinder Latch for 11851, 19871 and 19980	15
11854	3574	Shuttle Cylinder Latch Spring for 11851, obsolete	03
11855	3574	Shuttle Frame for 11851, obsolete, use 19870	1 75
11864	7287	Driving Attachment Shaft Driving Pulley, 10 in. diam., 1 1/4 in. face, 1 3/8 in. bore (sectional) with two 597c, for 8981, obsolete	1 30
11910	7268	Shuttle Bobbin for 8958, 11851, 19871 and 19980	25
11917	7251	Oil Cup Cover for 8949 and 16990	25
11918	7260	" or Wax Stripper Washer (steel) for 11917 for 16990	03
11919	7260	Oil Cup Thread Eyelet for 16990	05
12002	7268	Shuttle Cylinder Latch Pin for 11851, 19871 and 19980	01
12186	—	Driving Attachment Treadle complete for 27516, Nos. 2875, 2878, 9082 and four wood screws 1 in. No. 16, obsolete	70
12620	7288	Brace Bolt Nut Washer for 27006 ...	02
12620	7288	Leg Foot Screw Washer for 27244 ..	02
12620	7288	Rail Bolt Nut Washer for 27150	02
13351	—	Foot Lifter Chain, 46 in. to 55 in. long, for 11092 and 64010	30
16947	7271	Thread Take-up Spring for 6-1 to 6-4 Machines	10
16987	7261	Needle Bar Connecting Stud with two 129n, for 6-1 to 6-4 Machines	2 00

NO.	PLATE	NAME	EACH
16988	7261	Needle Clamp with 149F and 8749, for 6-1 to 6-4 Machines	\$1 25
16989	7251	Oil Cup for 16990	80
16990	7251	Oil Cup complete for 6-1 to 6-4 Machines, Nos. 2205, 8482, 9084, 11917 to 11919, 16989, two 8953 and three 207F	1 25
16994	7257	Presser Bar for 16999 for 6-1 to 6-4 Machines	1 25
16995	7266	Presser Bar Guide Bracket with 145D and 965D, for 6-1 to 6-4 Machines..	2 00
16996	7267	Presser Bar Lifter with 8761 and 8763	1 25
16997	7266	" " Lifting Link for 6-1 to 6-4 Machines	50
16999	5998	Presser Foot with two 346D, for 6-1 to 6-4 Machines	5 00
19079	7278	Wrench for 50364 (Accessories)	10
19520	7262	Foot Lifter Lifting Lever Spring for 11092 and 64010	15
19614	7250	Vibrating Presser Bar Spring Hook for 9040 and 64007	05
19869	7268	Shuttle Cylinder Latch Spring for 19870 and 19980	01
19870	3555	Shuttle Frame with 19869, for 19871, obsolete	1 75
19871	3555	Shuttle (cylinder) 3 in. diam., complete, Nos. 773H, 8961, 8964, 11852, 11853, 11910, 12002 and 19870, obsolete, use 19980	4 00
19967	7263	Feed Lifting Rock Shaft Wearing Block for 9225 and 64014	35
		Nos. 19977 to 19979 for 19980.	
19977	7268	Shuttle Cylinder	1 50
19978	7268	" Frame	1 75
19979	7268	" Tension Spring	40
19980	7268	Shuttle (cylinder) 3 in. diam., complete, Nos. 773H, 8961, 11853, 11910, 12002, 19869 and 19977 to 19979 ..	4 00
23535	7284	Wrench for 346 (Accessories)	20
25028	7270	Bobbin Winder Belt Hook for 11756, obsolete	01
25200	7284	Wrench for 340 (Accessories)	10
25881	894	Guide (6 in. face) for 6-1 to 6-4 Machines	40
26026	6047	Screw Driver, small (Accessories) ..	10

NO.	PLATE	NAME	EACH
26159	894	Guide (10 in. face) for 6-5 to 6-8 Machines	\$ 60
27006	7287	Brace (table) 27279 with 499E and two each 12620 and wood screws 1½ in. No. 14, for 27244	30
27032	7287	Leg, 22 in. wide, for 27244	1 10
27150	7287	Rail, 30 in., single flat, with two 492E, four each 12620, wood screws 1 in. No. 10 and six wood screws 1½ in. No. 14, for 27244	55
27244	---	Iron Work complete for 5271 for 6-4 Machine with S. D. A., Nos. two each 27006, 27032, 27150 and eight each 494E and 12620	4 50
27279	---	Brace (table) for 27006	20
27515	7258	Driving Attachment Treadle Pitman complete for 9076 and 27516, Nos. 2876, 9079 and 27639, obsolete ..	22
27516	---	Driving Attachment Treadle and Pitman complete for 8981, Nos. 12186 and 27515, obsolete	65
27555	7285	Bobbin Winder Thread Unwinder Spool Pin for 27556	08
27556	---	Bobbin Winder Thread Unwinder Spool Rest 27583 with 138B and two 27555, for 41823	40
27557	7285	Bobbin Winder Thread Unwinder Spool Stand with 138B, for 41823..	25
27560	7285	Bobbin Winder Thread Unwinder Thread Guard Rod, 26 in. long, for 41823	30
27583	7285	Bobbin Winder Thread Unwinder Spool Rest for 27556	20
27636	7253	Driving Attachment Treadle for 27642	30
27637	7251	" " " Pitman Rod (lower) for 27640	05
27638	7260	Driving Attachment Treadle Pitman Rod (lower) Spring for 27640	03
27639	7251	Driving Attachment Treadle Pitman Rod (upper) for 9077, 27515 and 27640	05
27640	7251	Driving Attachment Treadle Pitman complete for 27643, Nos. 2762, 9079 and 27637 to 27639	35

NO.	PLATE	NAME	EACH
27642	—	Driving Attachment Treadle complete for 27643, Nos. 2878, 9082, 27636 and four wood screws 1 in. No. 16	\$ 45
27643	—	Driving Attachment Treadle and Pitman complete for 9198, Nos. 27640 and 27642	80
Nos. 32869 to 32871 for 6-5 to 6-8 Machines.			
32869	7258	Presser Bar Spring (flat)	1 25
32870	7280	“ “ Guide Pin Bracket with 4389	1 00
32871	7280	Pressure Regulating Screw Bracket	1 00
32880	7265	Presser Bar for 43233, for 6-1 to 6-4 Machines	1 25
36565	6047	Oiler (copper plated) with 36566 (Accessories)	15
36566	6047	Oiler Spout, 9 in. long, for 36565	08
41441	6782	Bobbin Winder Frame Hinge Pin for 41900	10
41446	6781	Bobbin Winder Stop Latch Hinge Pin for 41900	10
41452	7285	Bobbin Winder Thread Unwinder Thread Guard for 41453	40
41453	—	Bobbin Winder Thread Unwinder Thread Guard complete for 41823, Nos. 330D, 637C, 1560C, 2103, 5769, 41452 and two 2102	70
41514	7285	Bobbin Winder Thread Unwinder Spool Weight, 4 in. diam., with 41515, for 41823	15
41515	7250	Bobbin Winder Thread Unwinder Spool Weight Centre Pin for 41514	05
41544	7250	Thread Take-up Spring Regulator Screw Washer for 6-5 to 6-8 Machines	05
41544	7250	Thread Take-up Staple Screw Washer	05
41557	6781	Bobbin Winder Stop Latch for 41900	15
41823	7285	Bobbin Winder Thread Unwinder complete, for two large spools, for 41903 and 41904, Nos. 27556, 27557, 27560, 41453, two 41514 and three wood screws 1½ in. No. 12	1 95
41894	6781	Bobbin Winder Base with 449C, for 41900	50
41895	7270	Bobbin Winder Bobbin Carrier Key for 41898	01

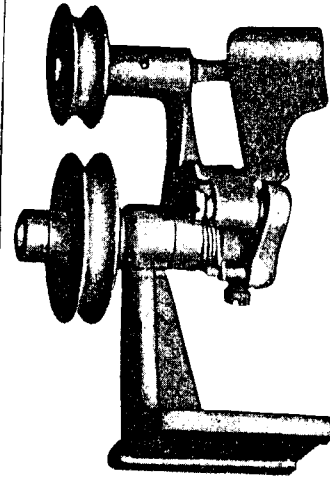
NO.	PLATE	NAME	EACH
Nos. 41896 to 41899 for 41900.			
41896	6782	Bobbin Winder Frame	\$ 35
41897	6782	“ “ Spring	05
41898	6781	“ “ Spindle with 41895	25
41899	6782	“ “ Tripping Arm with 176D	20
41900	6781	“ “ for 41903 and 41904, Nos. 2269, 41441, 41446, 41557, 41894, 41896 to 41899, 43176 to 43178, two 4784 and three 131D	3 45
41901	7252	Bobbin Winder Bracket for 41903	75
41902	7252	“ “ “ 41904	75
41903	—	Bobbin Winder (swinging automatic, left hand) complete for 6-1, 6-3, 6-5 and 6-7 Machines, Nos. 523D, 41823, 41900, 41901 and three 894D	6 45
41904	—	Bobbin Winder (swinging automatic, left hand) complete for 6-2, 6-4, 6-6 and 6-8 Machines, Nos. 523D, 41823, 41900, 41902 and three 894D	6 45
43154	7254	Thread Guard (front of arm) for 6-1 to 6-4 Machines	05
43155	7254	Thread Eyelet (side of arm)	05
43157	7271	“ Take-up Spring Lever with 8077, for 6-1 to 6-4 Machines	1 75
Nos. 43176 to 43178 for 41900.			
43176	6782	Bobbin Winder Pulley (leather)	75
43177	6782	“ “ “ Flange with two 448C	35
43178	6782	Bobbin Winder Pulley Washer	50
43184	7284	Wrench for 1606 (Accessories)	50
43232	6001	Roller Arm Bracket with two 346D, for 43233	3 50
43233	6000	Roller Presser complete, 2½ in. roller, for 6-1 to 6-4 Machines, Nos. 327D, 423F, 1520F, 1992, 8771, 8773, 43232 and two each 307F and 1513J	10 00
43263	7270	Arm Screw Washer	05
50124D	7276	Feed Rock Shaft Crank Clamping Screw for 9211 and 9229	12
50322D	7274	Feed Regulator Thumb Screw	40
50323D	7274	Presser Bar Spring Regulating Screw for 6-1 to 6-4 Machines	10
50349E	7274	Arm Screw	15
50355E	7254	Ratchet Pawl Screw Stud for 9210	15

NO.	PLATE	NAME	EACH
50364c	7278	Vibrating Presser Bar Cap and Tension Bracket Screw Set Screw for 64007	\$ 06
58252	7267	Presser Bar Spring Bracket for 6-1 to 6-4 Machines	25
61504	7253	Balance Wheel and Pulley (tight) with two 344c, for 6-1, 6-3, 6-5 and 6-7 Machines	6 00
Nos. 64001 to 64003 for 6-5 to 6-8 Machines.			
64001	7262	Shuttle Race Slide (left)	50
64002	7281	Thread Take-up Lever with 1513j, 1865 and 9219	3 00
64003	7278	Thread Take-up Spring Regulator ..	10
64004	7282	Throat Plate with 225F and 9126, for 9235	1 75
64005	7280	Vibrating Presser Bar with 9040 and two 9291, for 64006	2 00
64006	—	Vibrating Presser Bar complete for 6-5 to 6-8 Machines, Nos. 598D, 8561, 64005 and 64008	3 55
64007	7280	Vibrating Presser Bar Cap and Tension Bracket with 19614 and two each 1547D and 50364c, for 6-5 to 6-8 Machines	2 50
64008	7279	Vibrating Presser Foot for 64006	1 50
64009	7258	Foot Lifter Lifting Lever for 64010..	2 25
64010	—	Foot Lifter complete for 6-5 to 6-8 Machines, Nos. 32D, 2049, 4885, 8055, 11023, 13351, 19520 and 64009	3 55
64011	7294	Throat Plate for 9086 for 9015, obsolete	1 00
Nos. 64012 to 64018 for 6-7 and 6-8 Machines.			
64012	7283	Feed Dog	1 25
64013	7257	" Forked Connection	2 00
64014	7251	" Lifting Rock Shaft with 134D, 2022 and 19967, for 64015	1 75
64015	—	Feed Lifting Rock Shaft complete, Nos. 64014 and 64016	4 25
64016	7255	Feed Lifting Rock Shaft Crank with 611D, 1619F and 1926, for 64015 ..	2 50
64017	—	Feed Rock Shaft complete, Nos. 9054 and 9211	4 25
64018	7283	Throat Plate with 225F and 9126, for 64012	1 75

ILLUSTRATIONS OF PARTS
FOR
MACHINES Nos. 6-1 to 6-8

PLATE 607.—ONE-HALF SIZE.

9061



9066



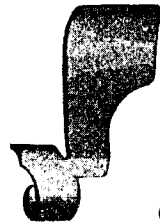
2448

9067

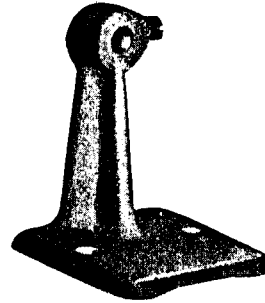


9069

9068



9062



9063



9065

9070



9074



PLATE 833—FULL SIZE

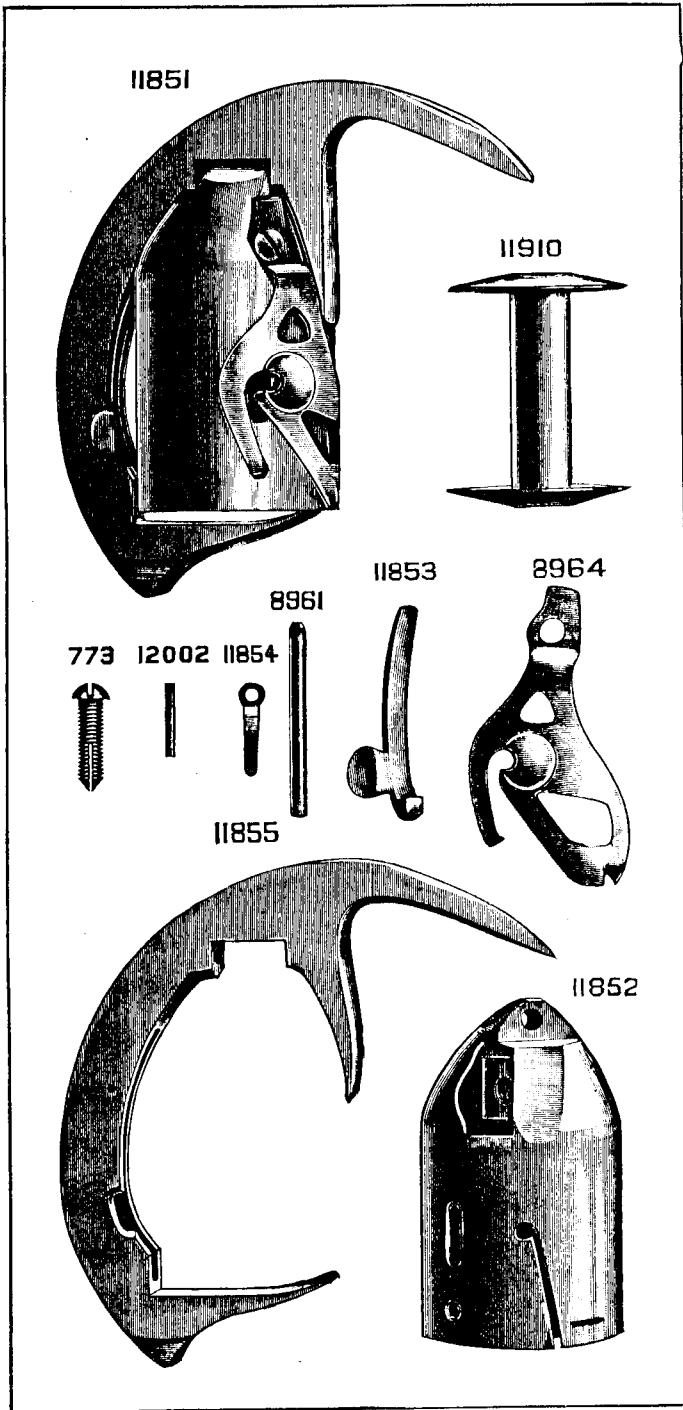


PLATE 894—ONE-HALF SIZE

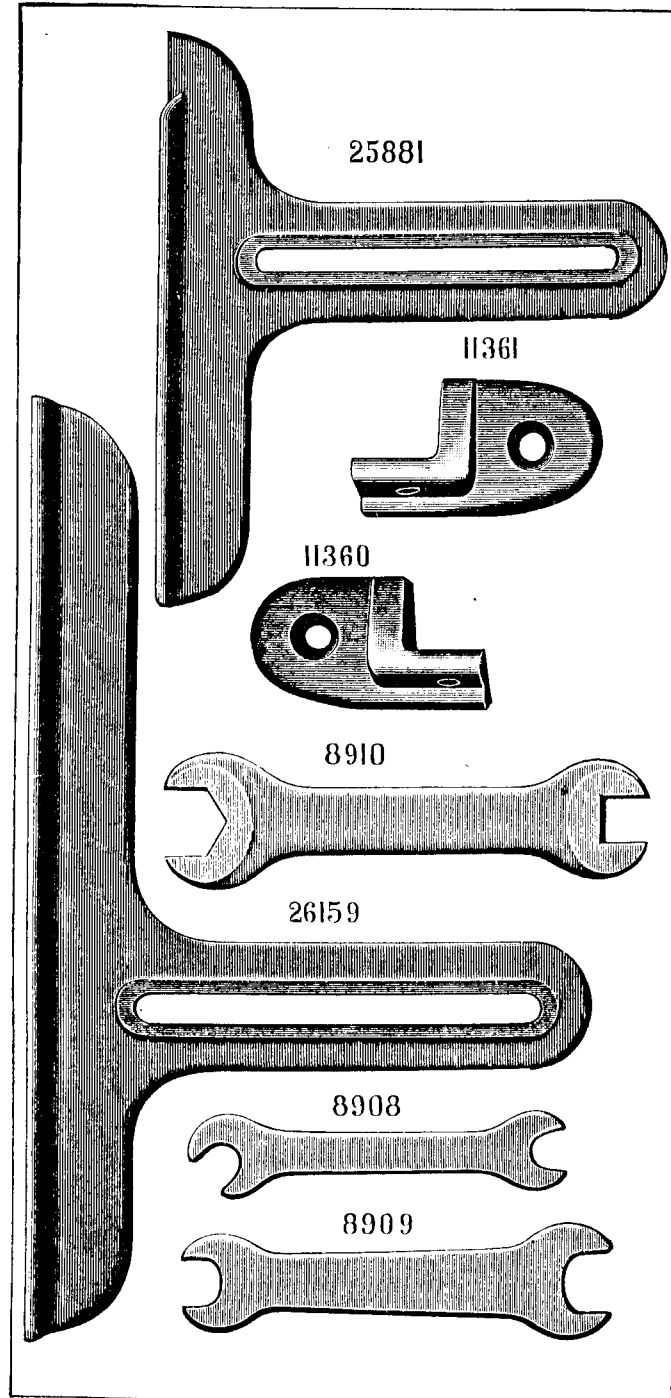
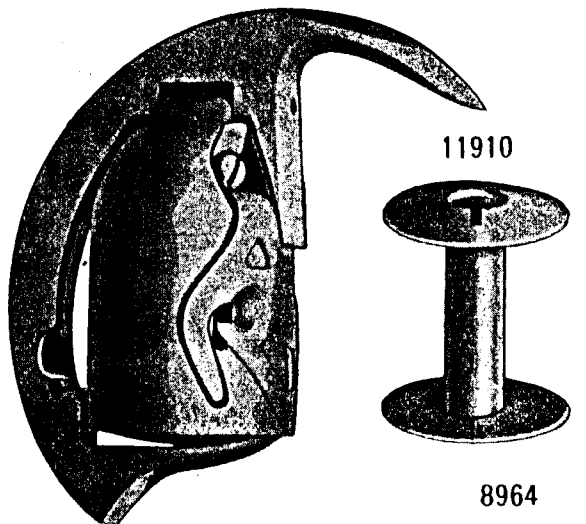
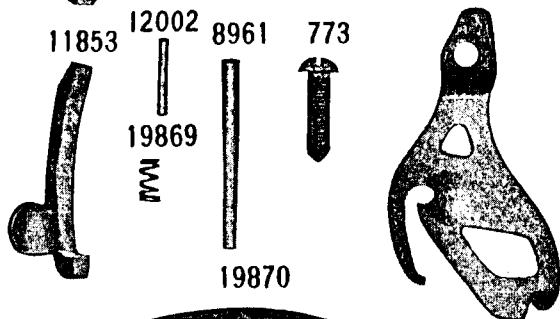


PLATE 3555—FULL SIZE

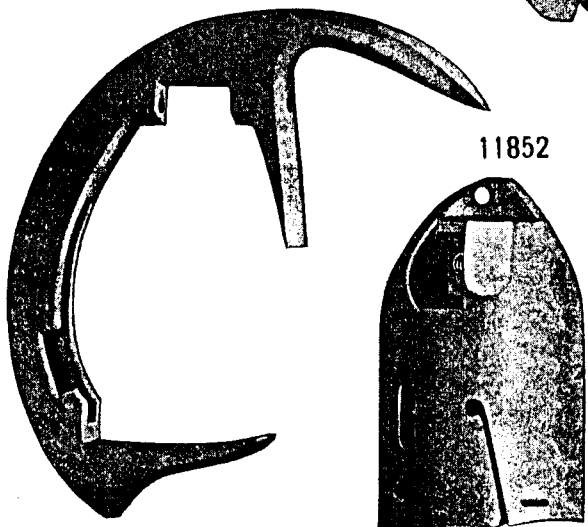
19871



11910



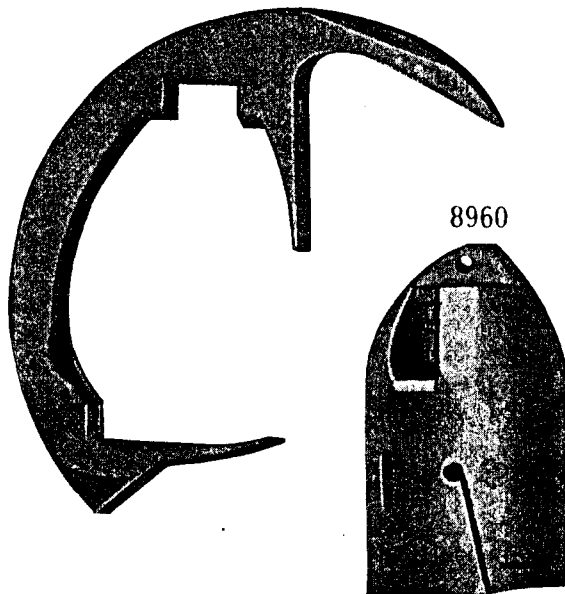
19870



11852

PLATE 3574—FULL SIZE

8963



8960

590 11854 8962

11855

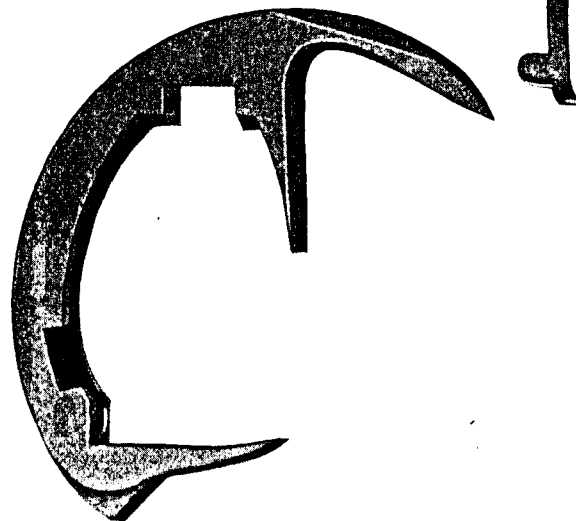
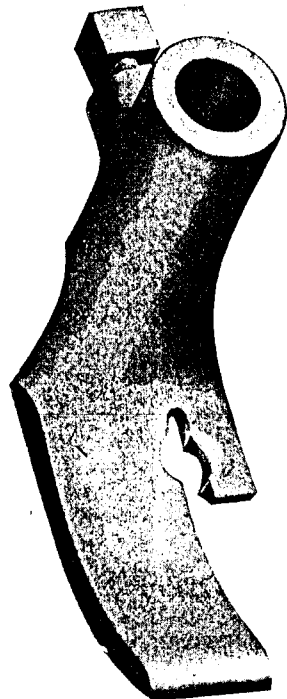


PLATE 5998—FULL SIZE

8768



16999

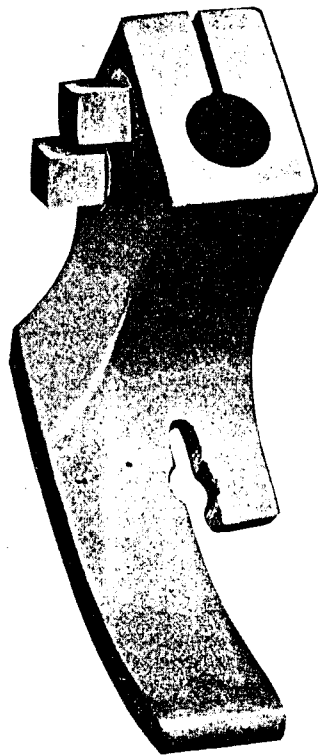


PLATE 6000—FULL SIZE

43233

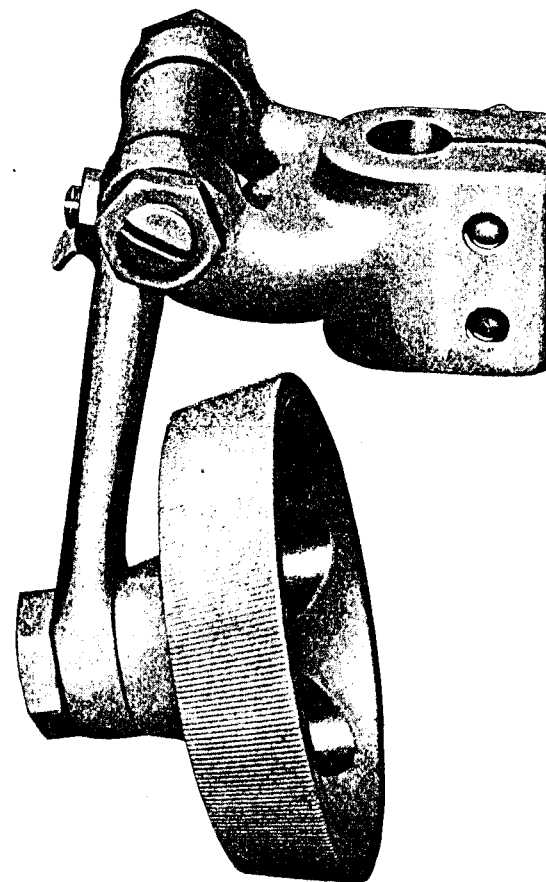


PLATE 6001—FULL SIZE

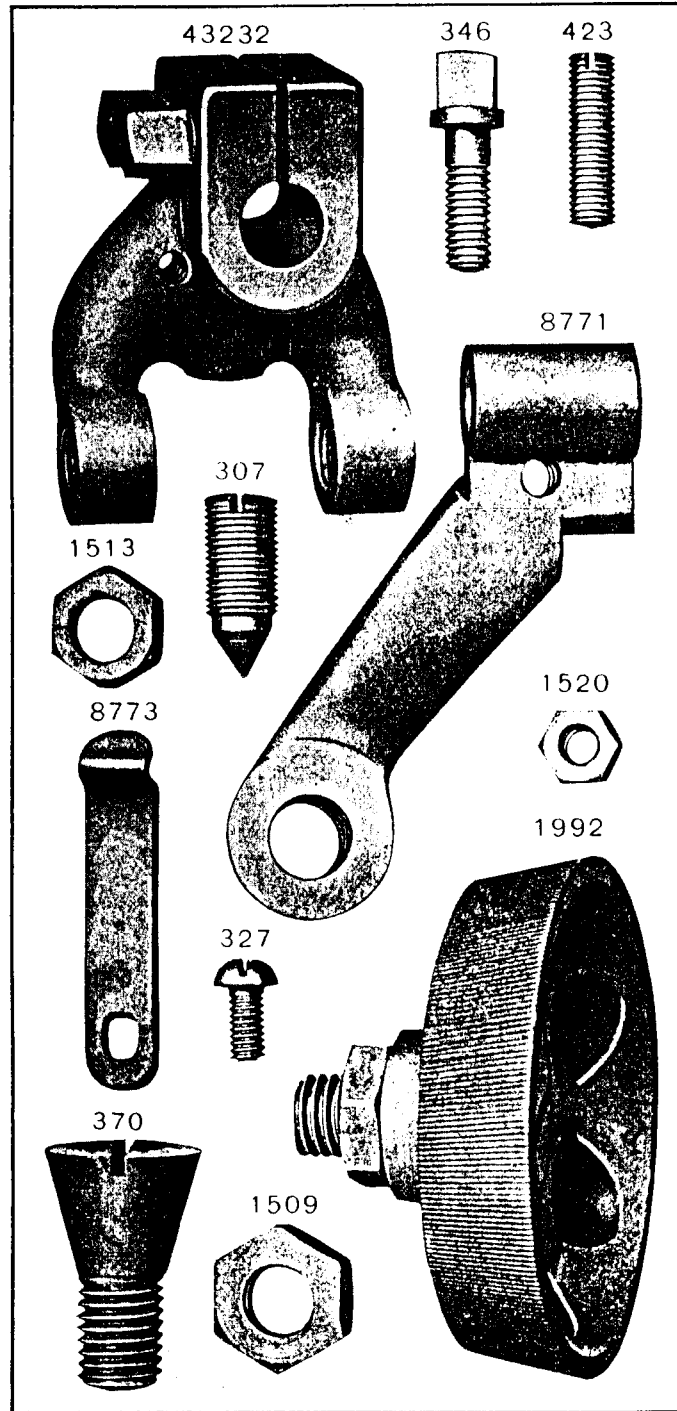


PLATE 6037—FULL SIZE

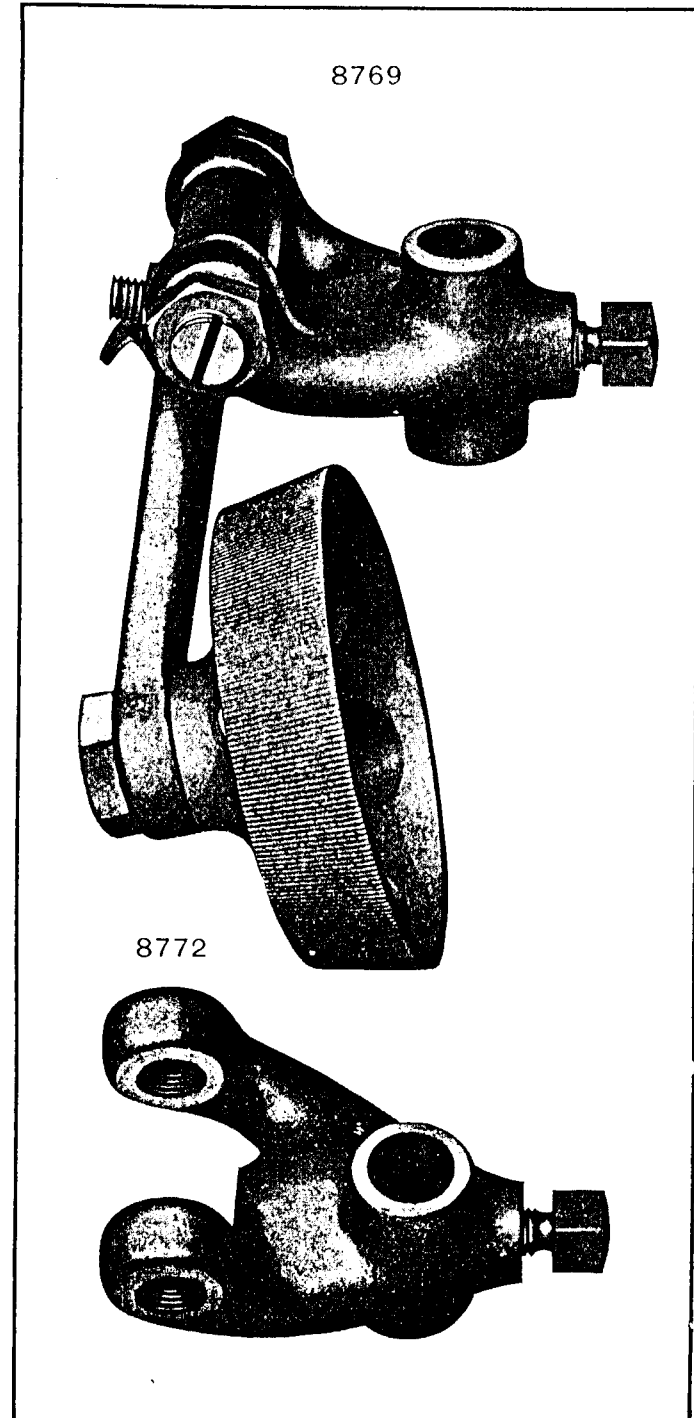


PLATE 6047—ONE-HALF SIZE

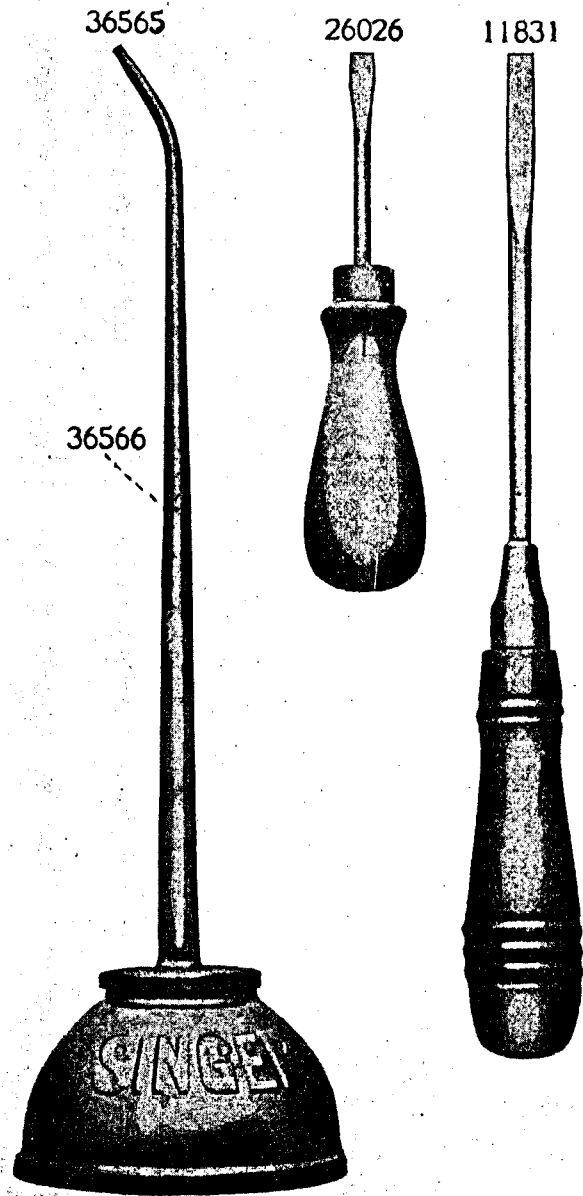


PLATE 6053—FULL SIZE

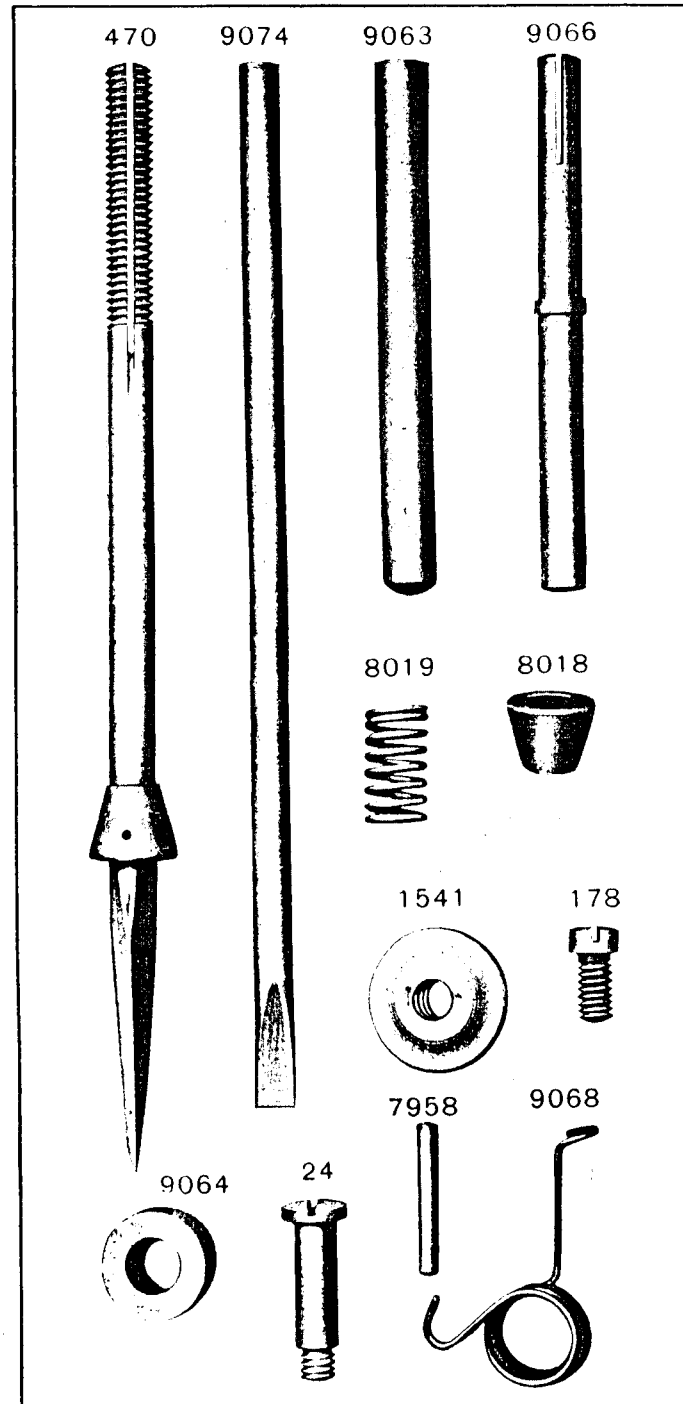


PLATE 6054—ONE-HALF SIZE

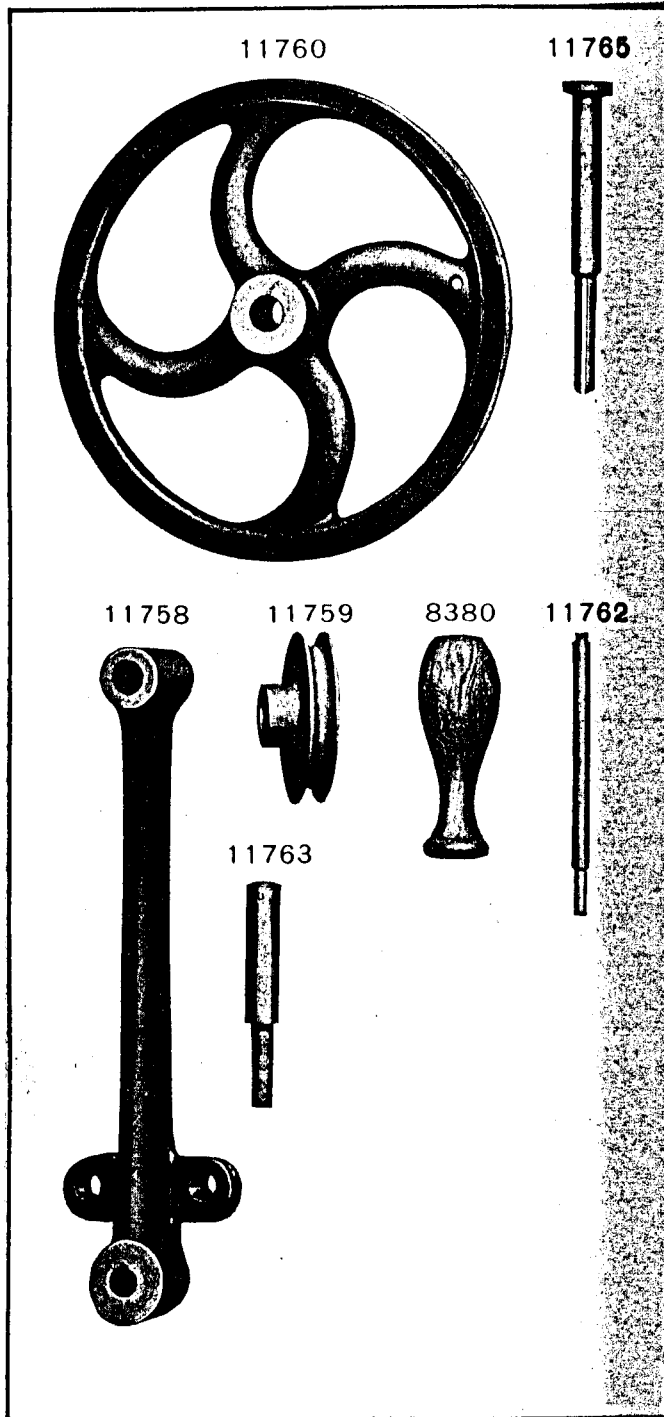


PLATE 6781—ONE-HALF SIZE

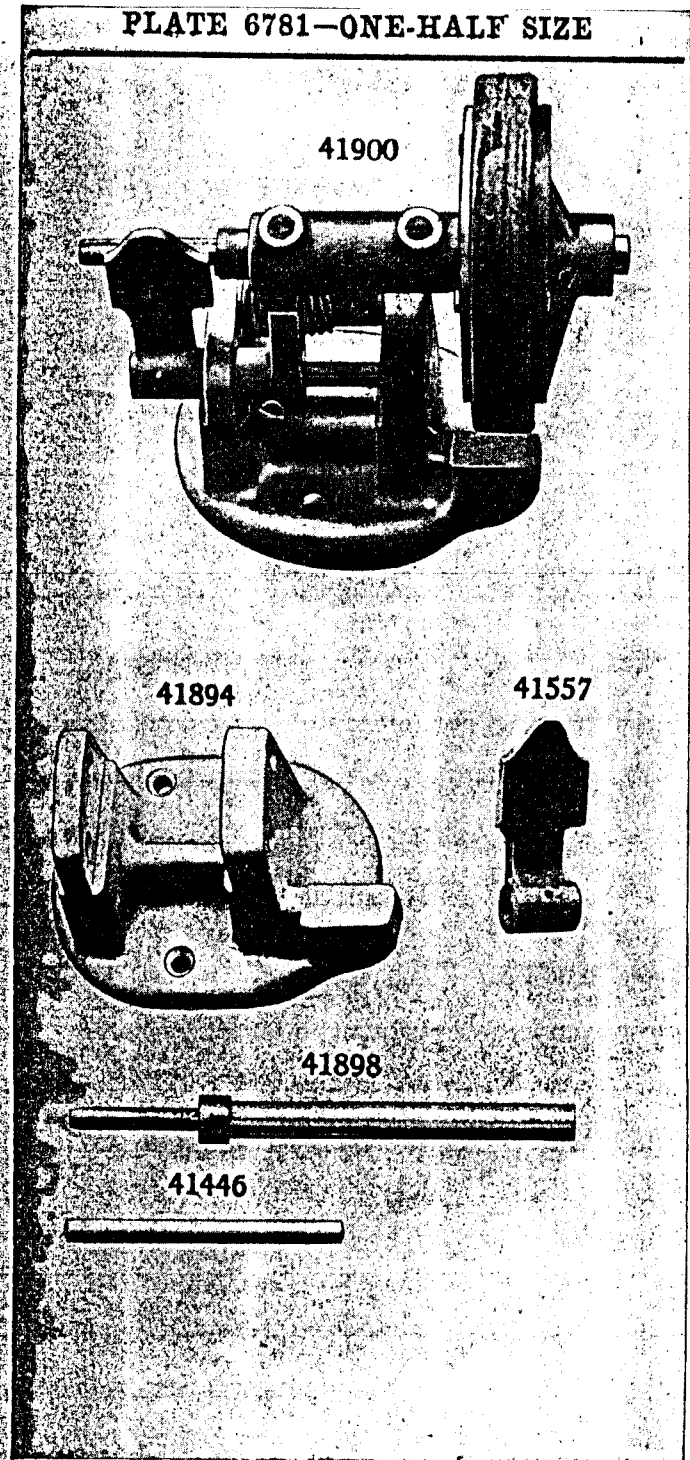
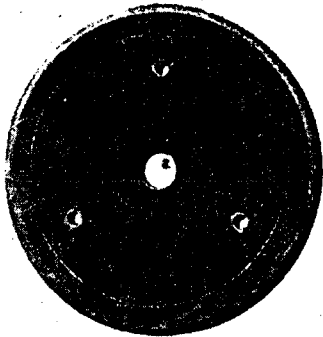
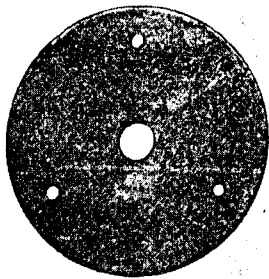


PLATE 6782—ONE-HALF SIZE

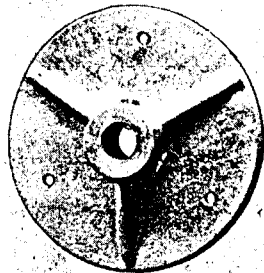
43176



43178



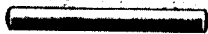
43177



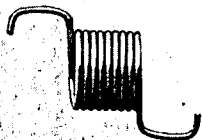
41896



41441



41897



41899



PLATE 7250—FULL SIZE

8708



8983



8714



9207



8873



9082



9219



11838



2022



2117



8702



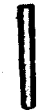
3012



41515



2269



9291



8761



4389



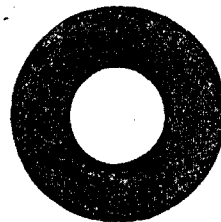
8763



8973



8760



11446



19614



41544



11833



8765



PLATE 7251—ONE-FOURTH SIZE

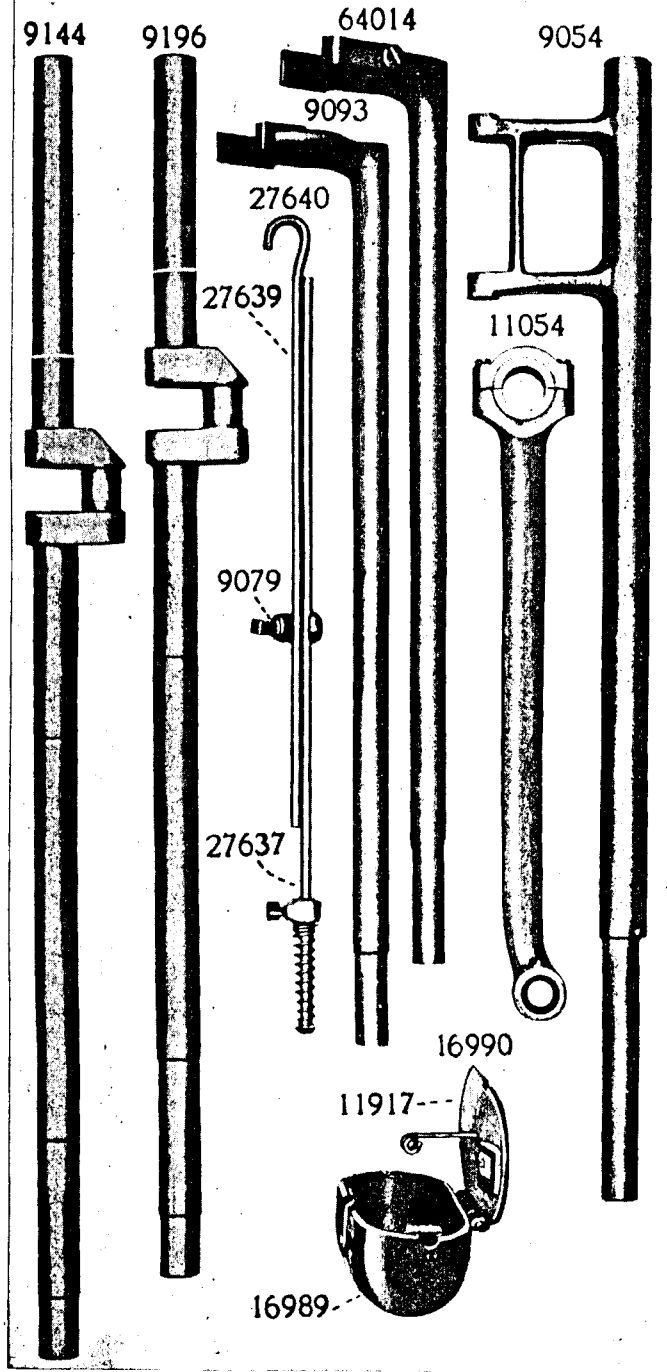


PLATE 7252—ONE-FOURTH SIZE

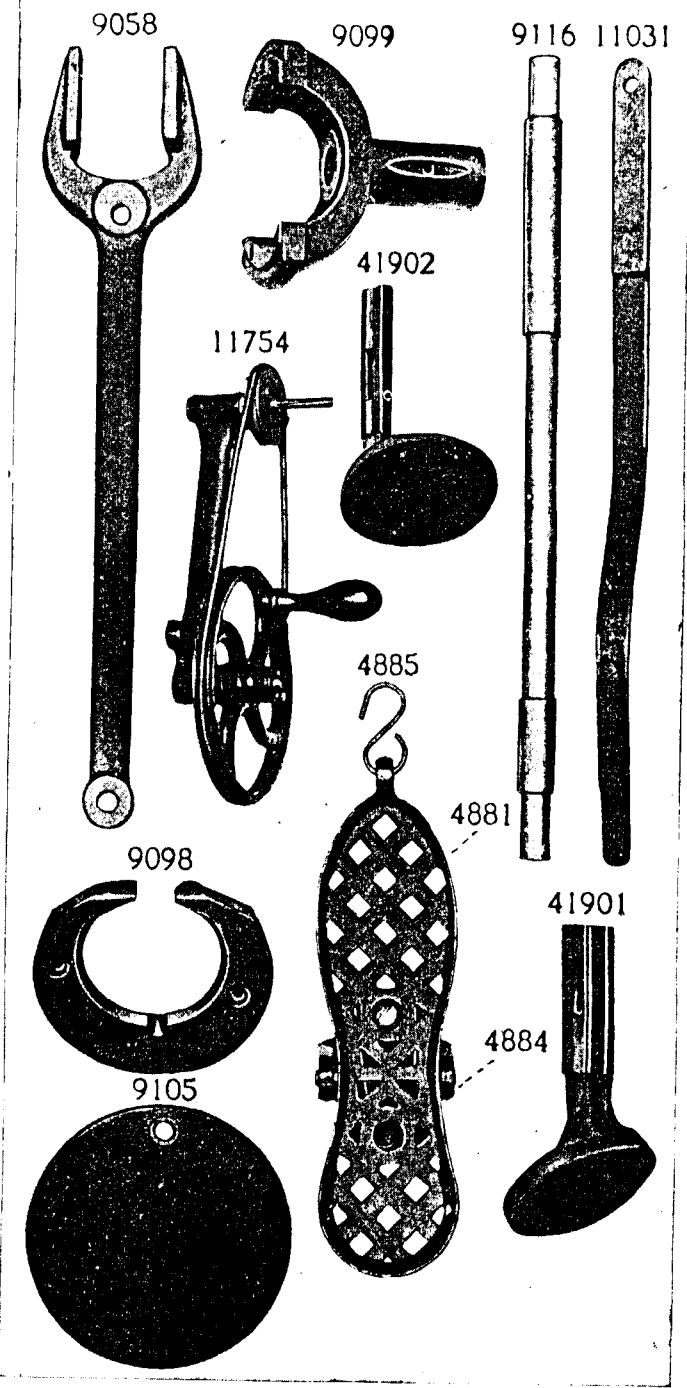


PLATE 7253—ONE-NINTH SIZE

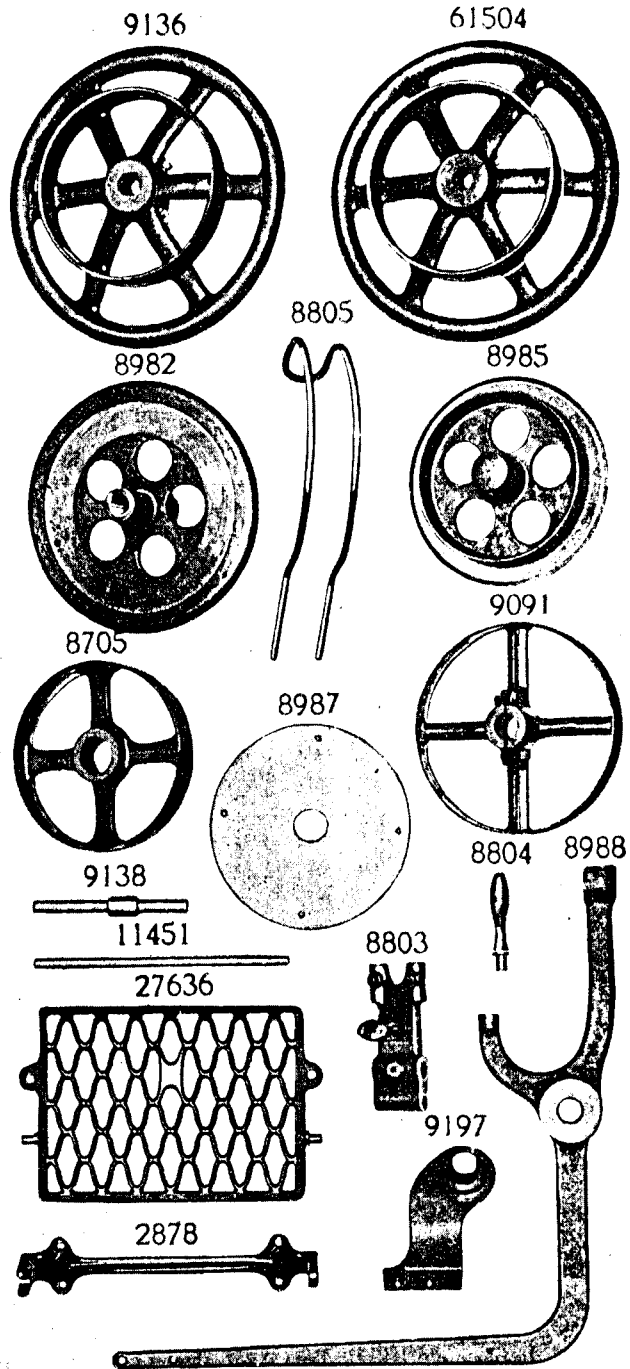


PLATE 7254—FULL SIZE

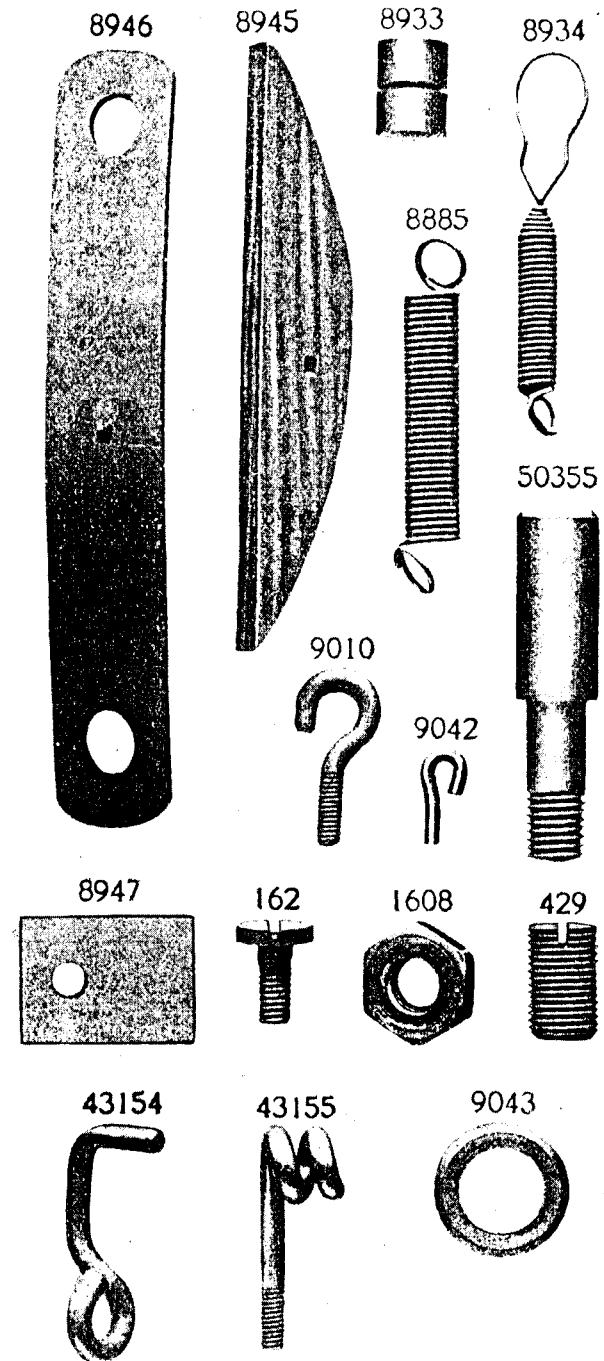
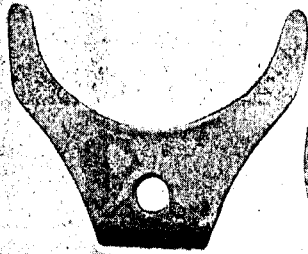
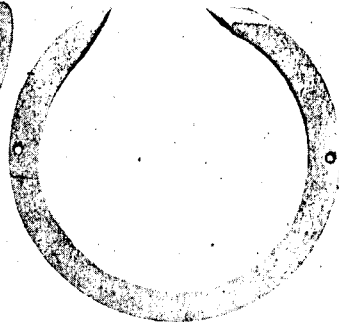


PLATE 7255—ONE-HALF SIZE

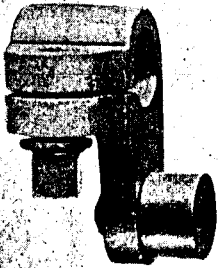
11834



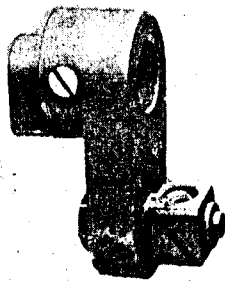
11832



64016



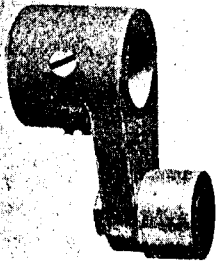
9154



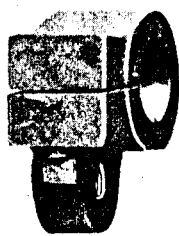
8927



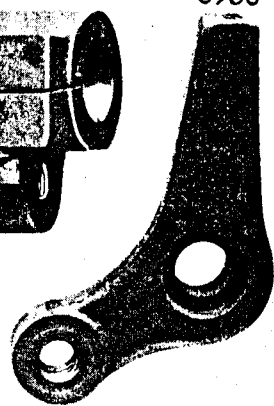
9096



9211



8930



8994

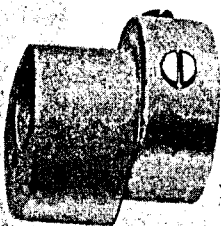
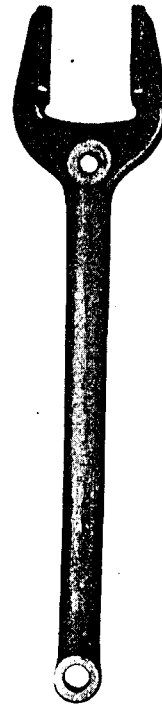


PLATE 7256—ONE-FOURTH SIZE

8929



9225



PLATE 7257—ONE-FOURTH SIZE

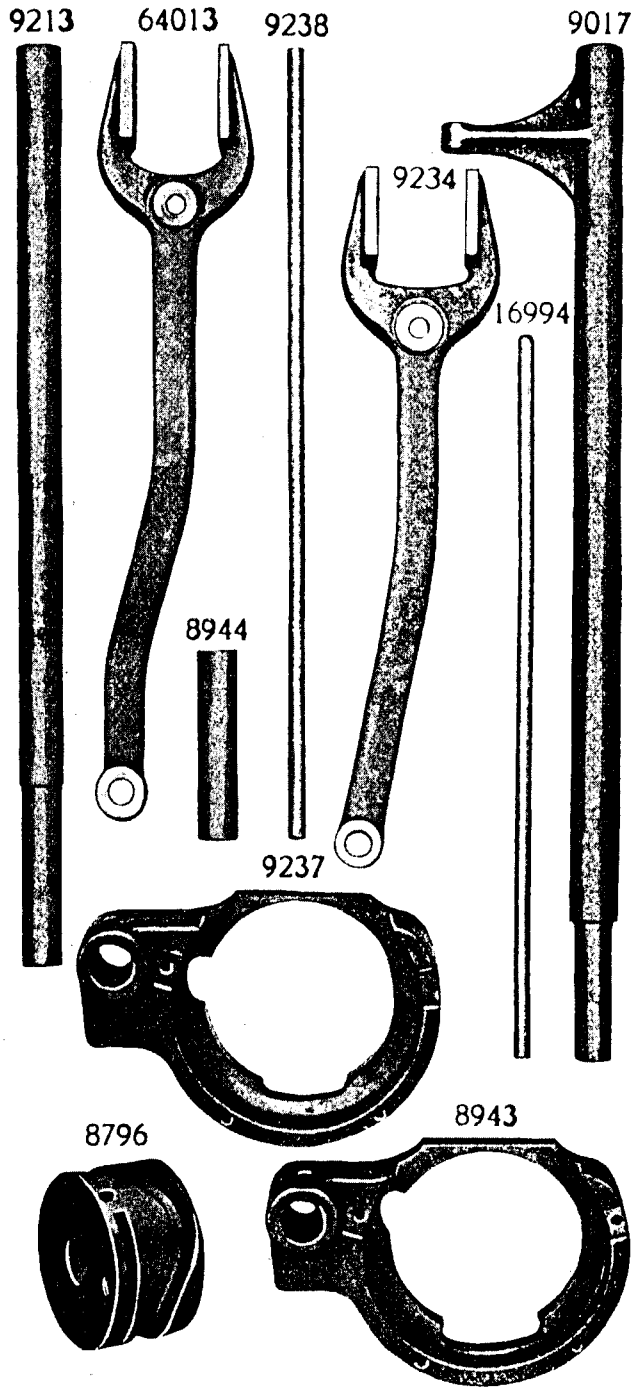


PLATE 7258—ONE-FOURTH SIZE

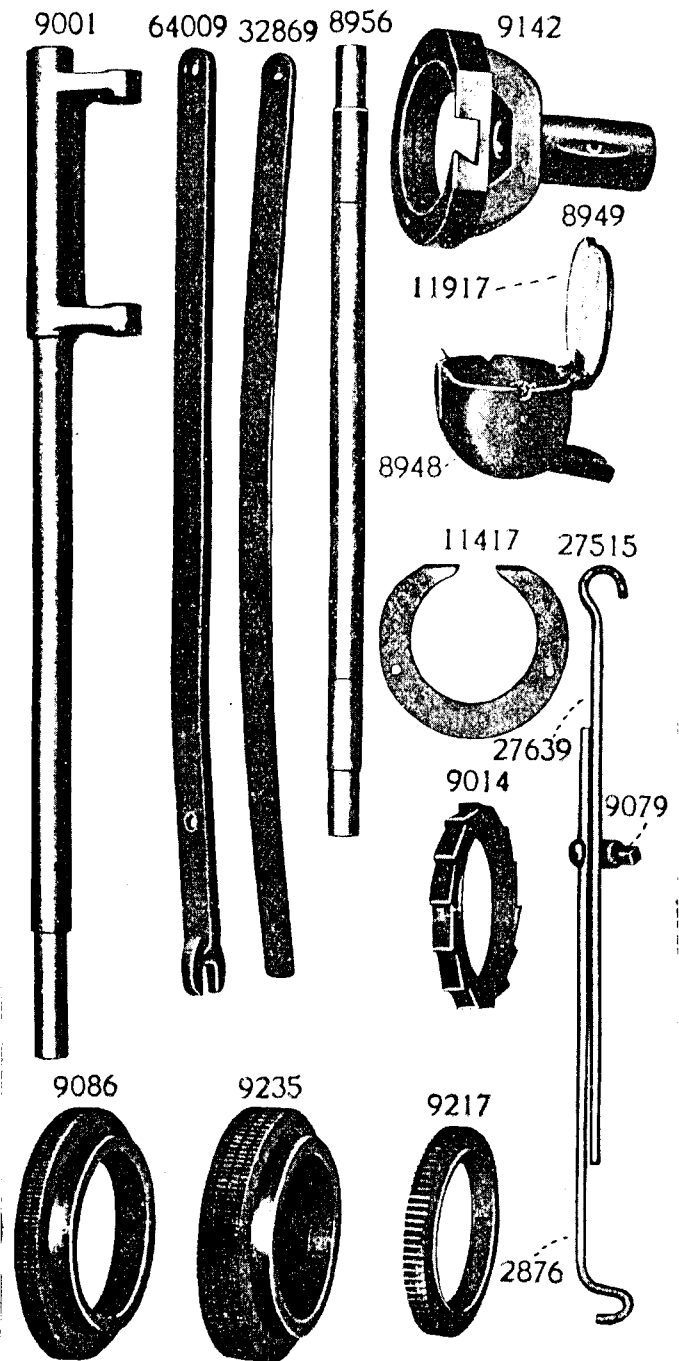


PLATE 7259—ONE-HALF SIZE

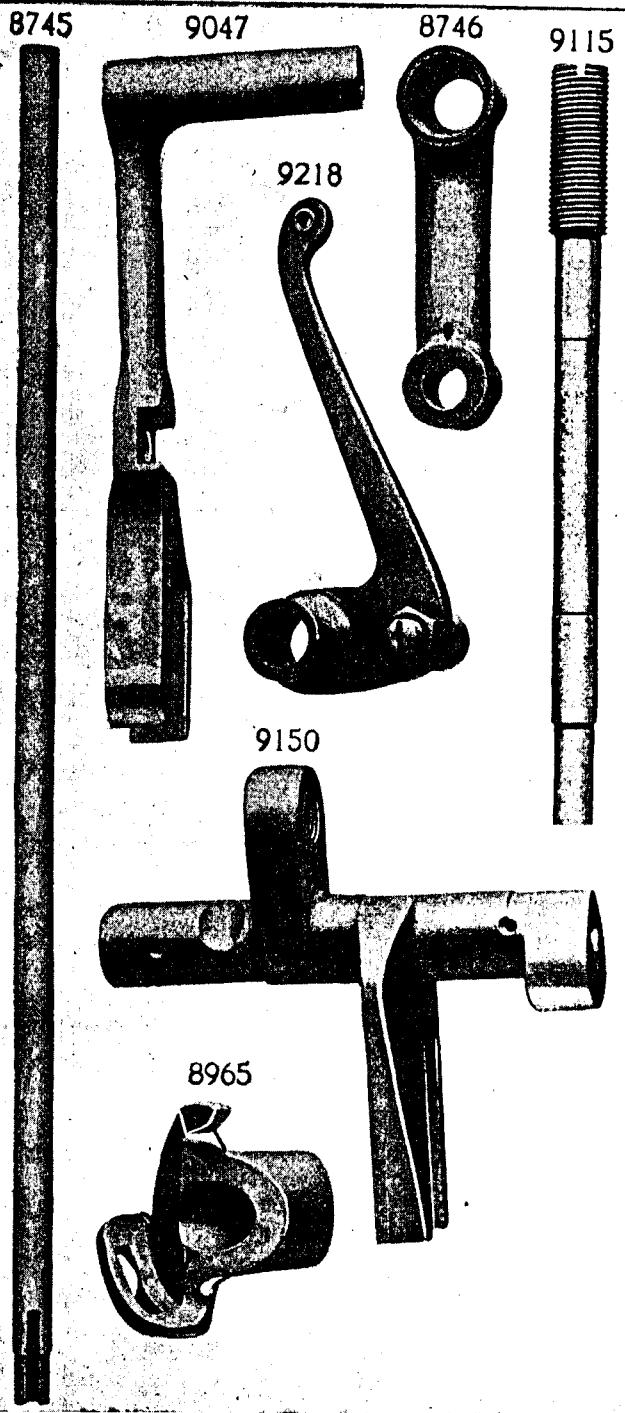


PLATE 7260—FULL SIZE

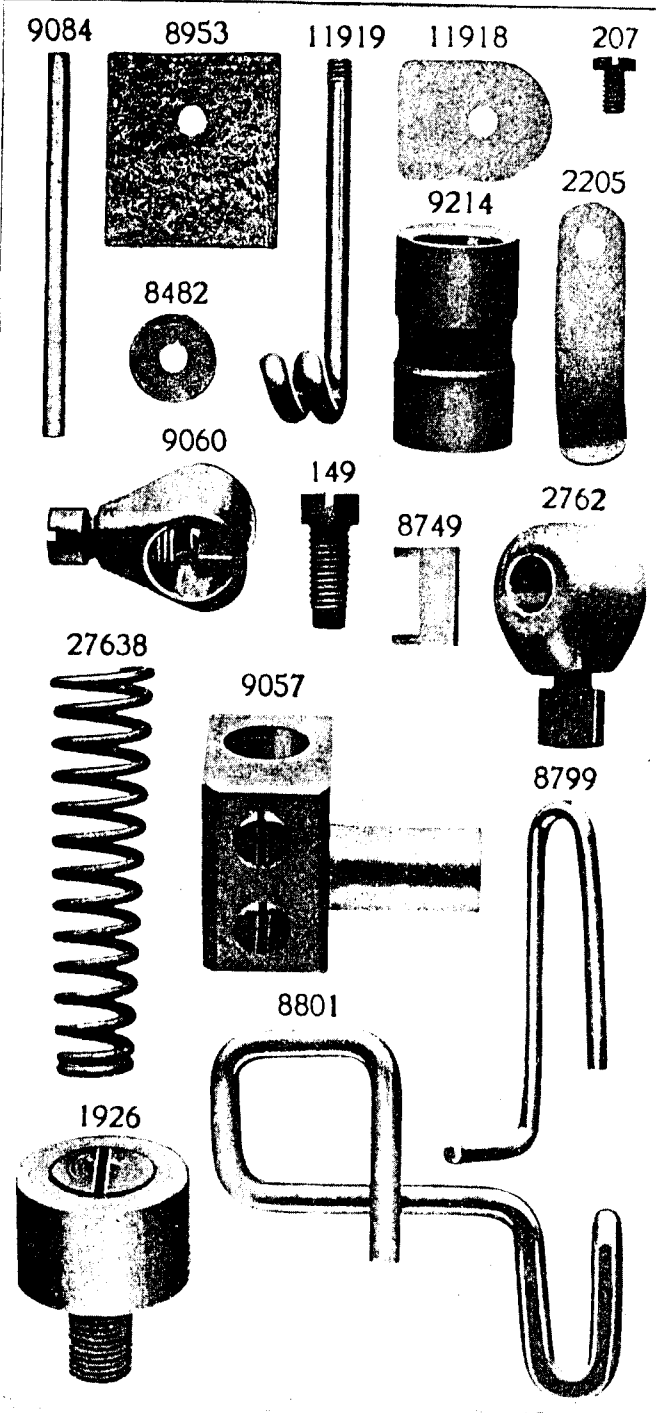


PLATE 7261—FULL SIZE

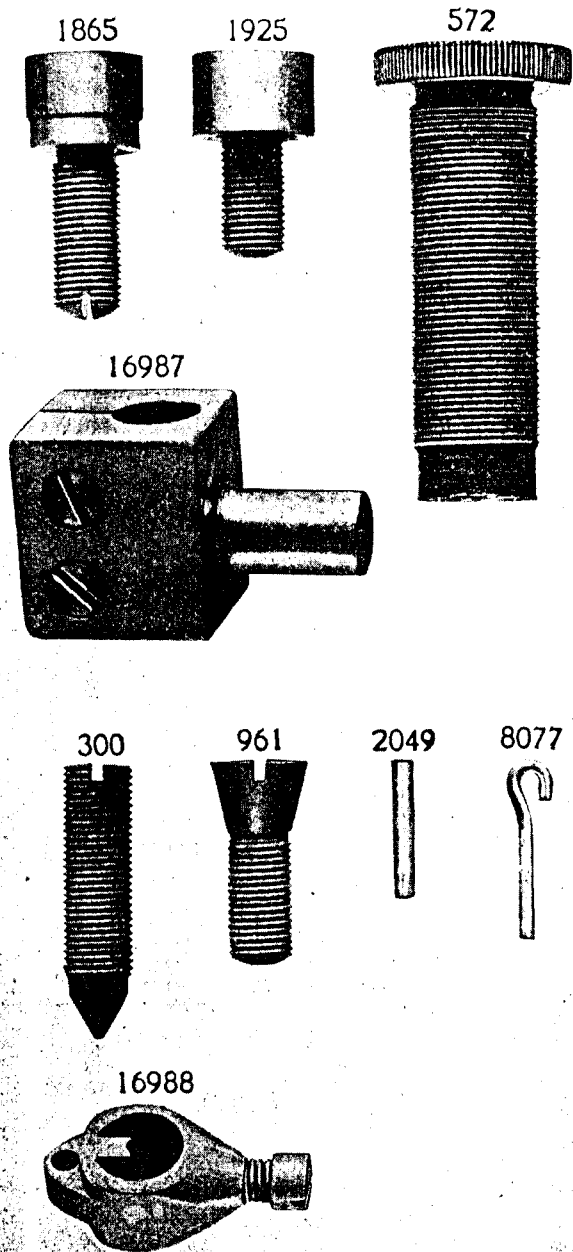


PLATE 7262—ONE-HALF SIZE

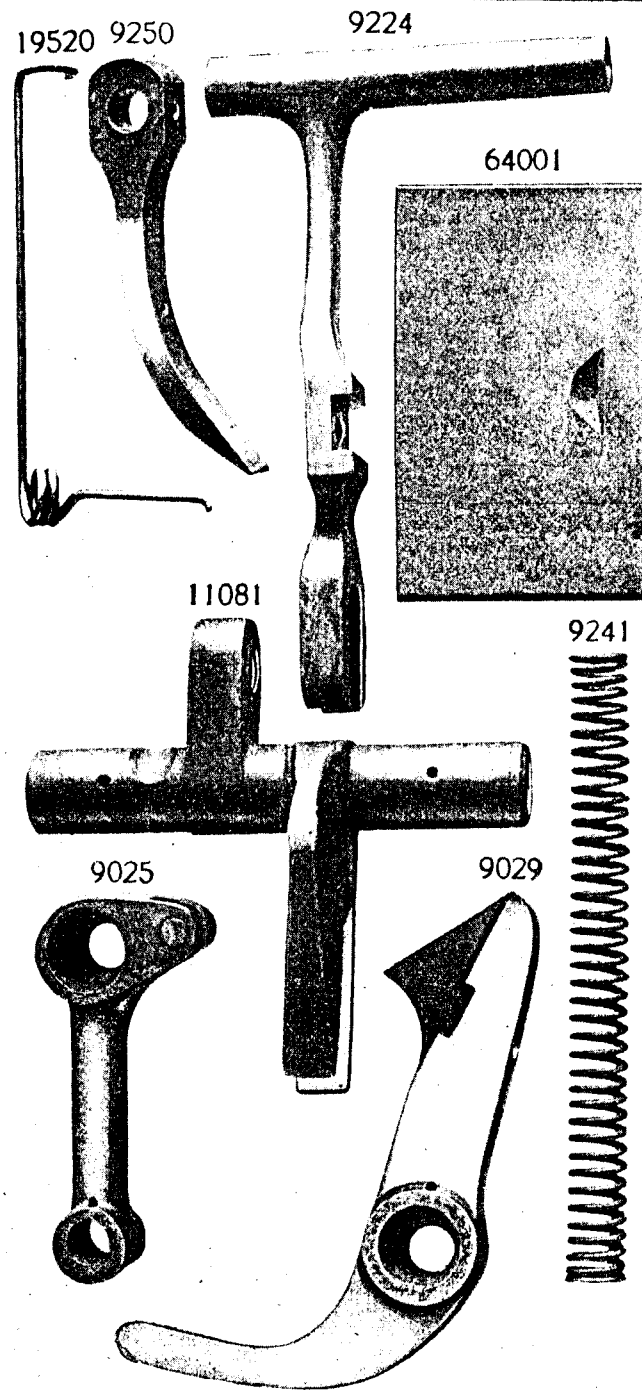


PLATE 7263—FULL SIZE

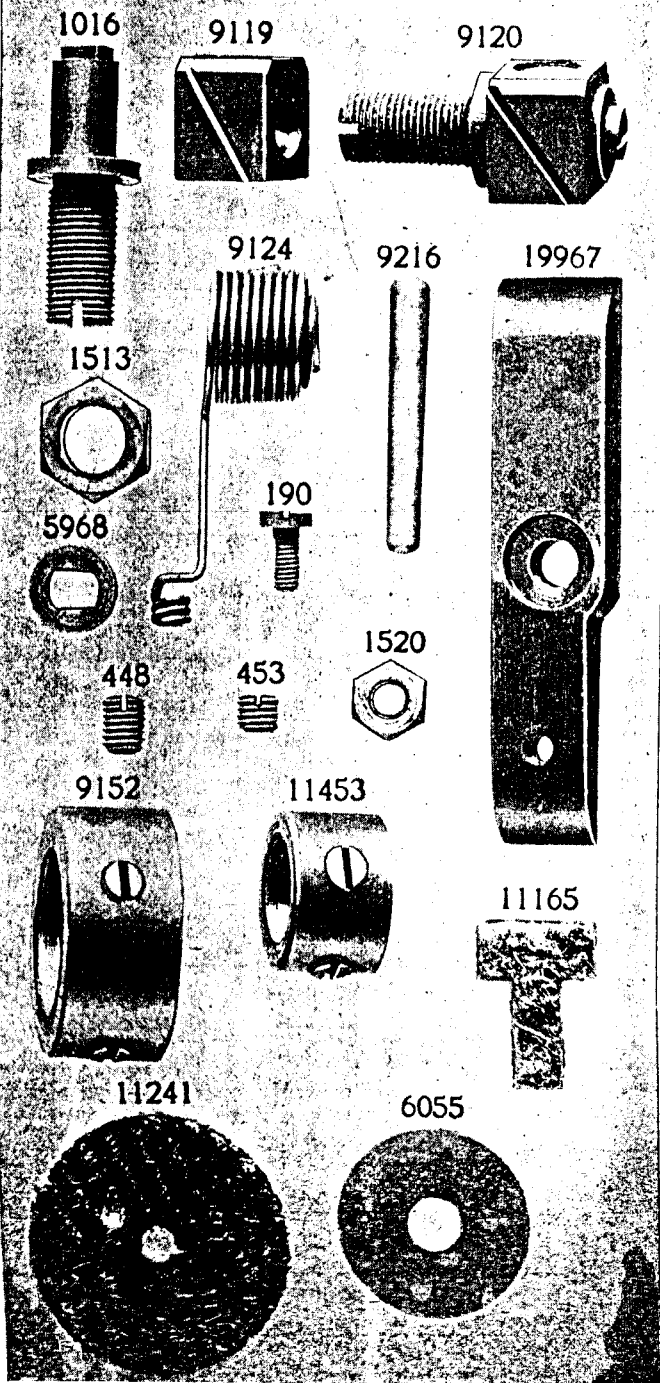


PLATE 7264—ONE-HALF SIZE

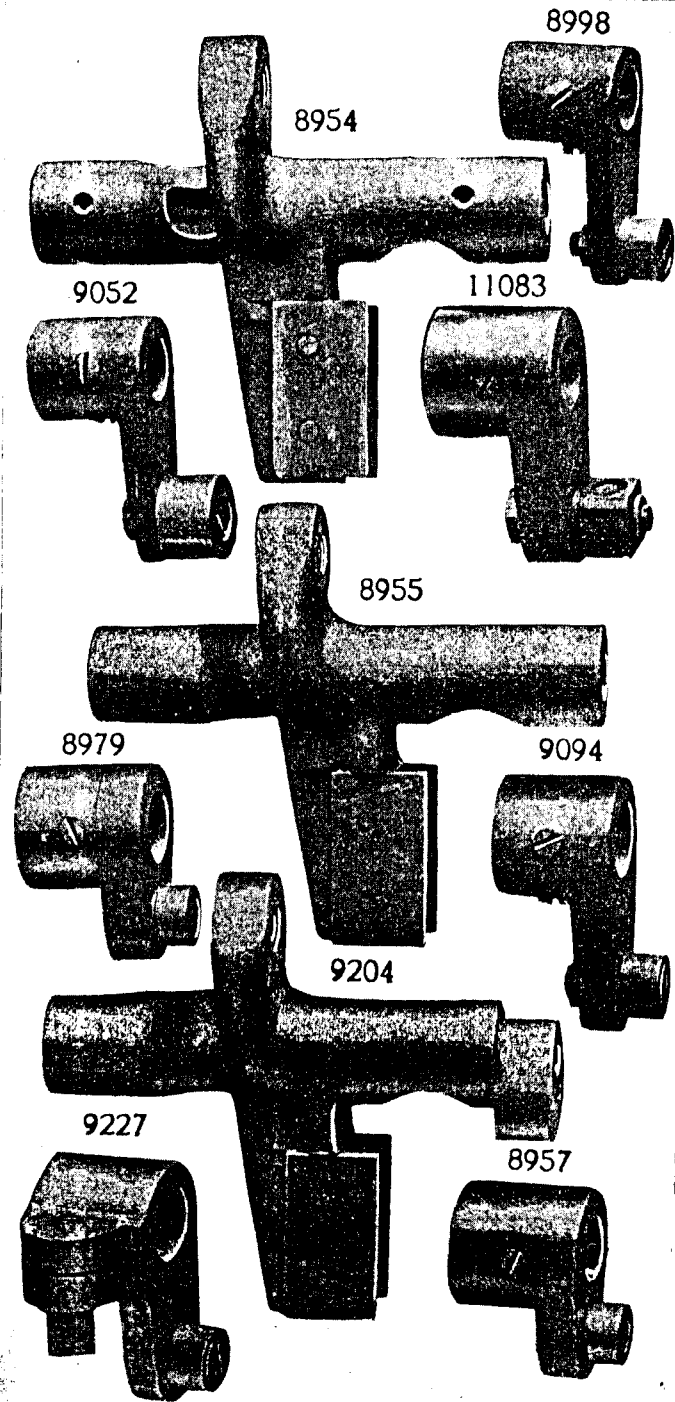


PLATE 7265—ONE-HALF SIZE

9134 8758 32880 9020 9247 9028

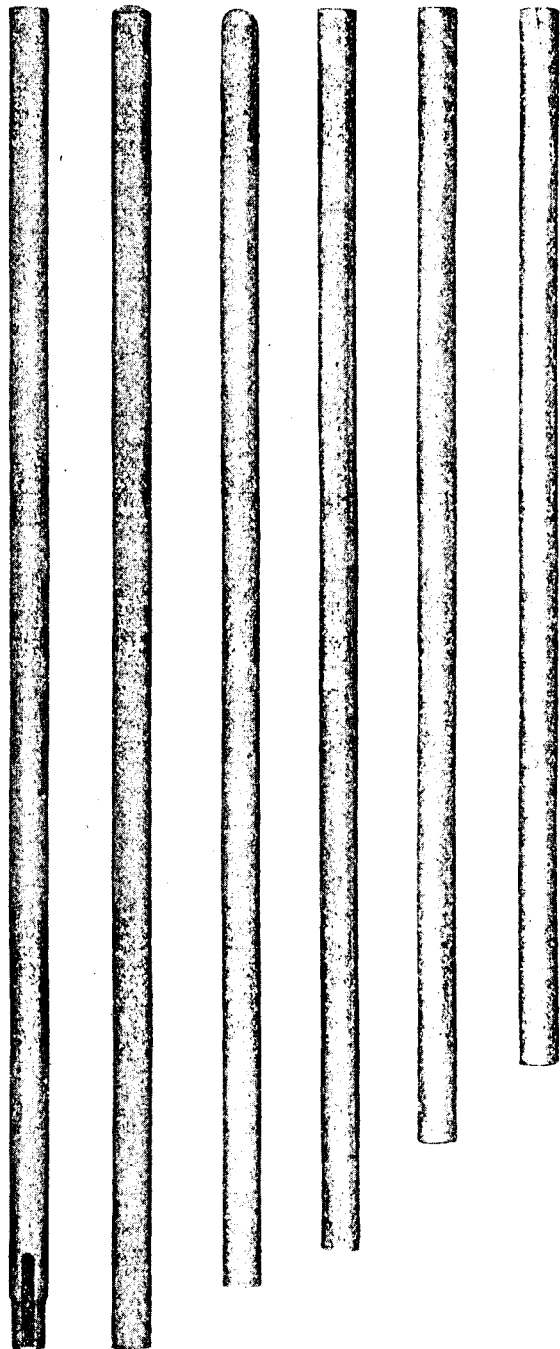


PLATE 7266—ONE-HALF SIZE

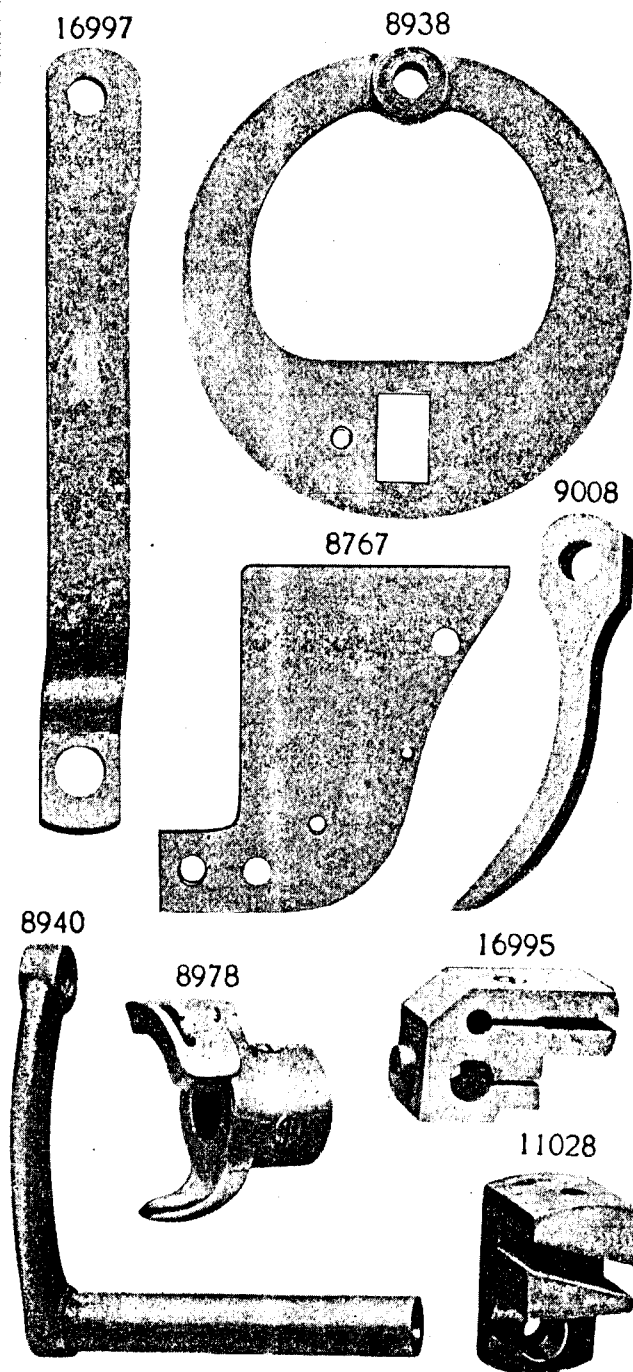
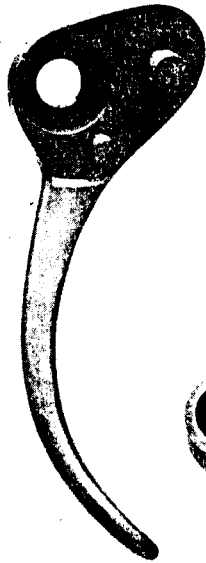


PLATE 7267—ONE-HALF SIZE

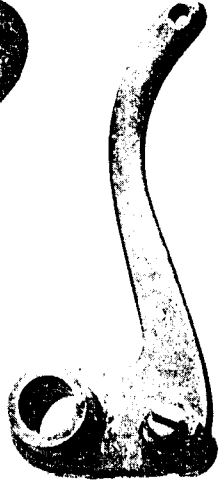
8792



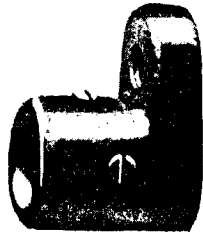
16996



8968



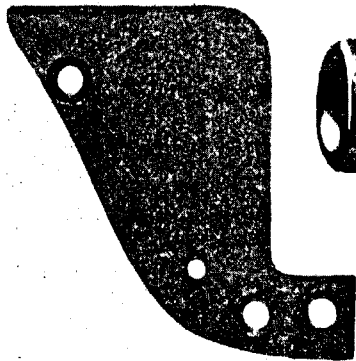
9055



9222



9110

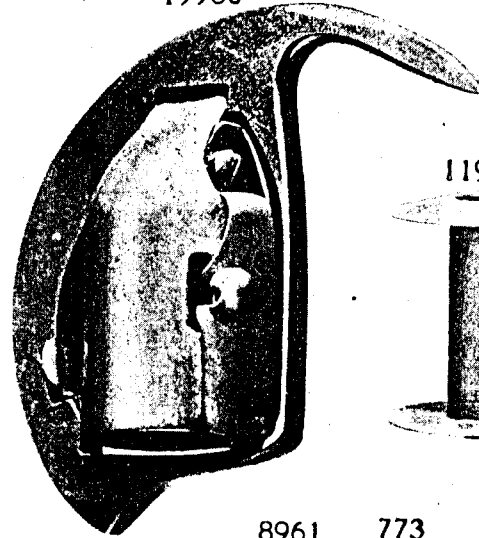


58252

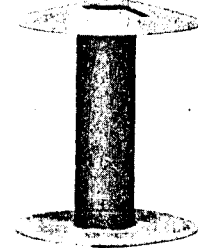


PLATE 7268—FULL SIZE

19980



11910



8961



773



19979



11853



12002



19869



19978



19977

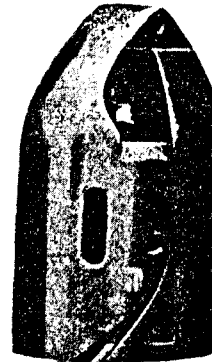


PLATE 7269—ONE-HALF SIZE

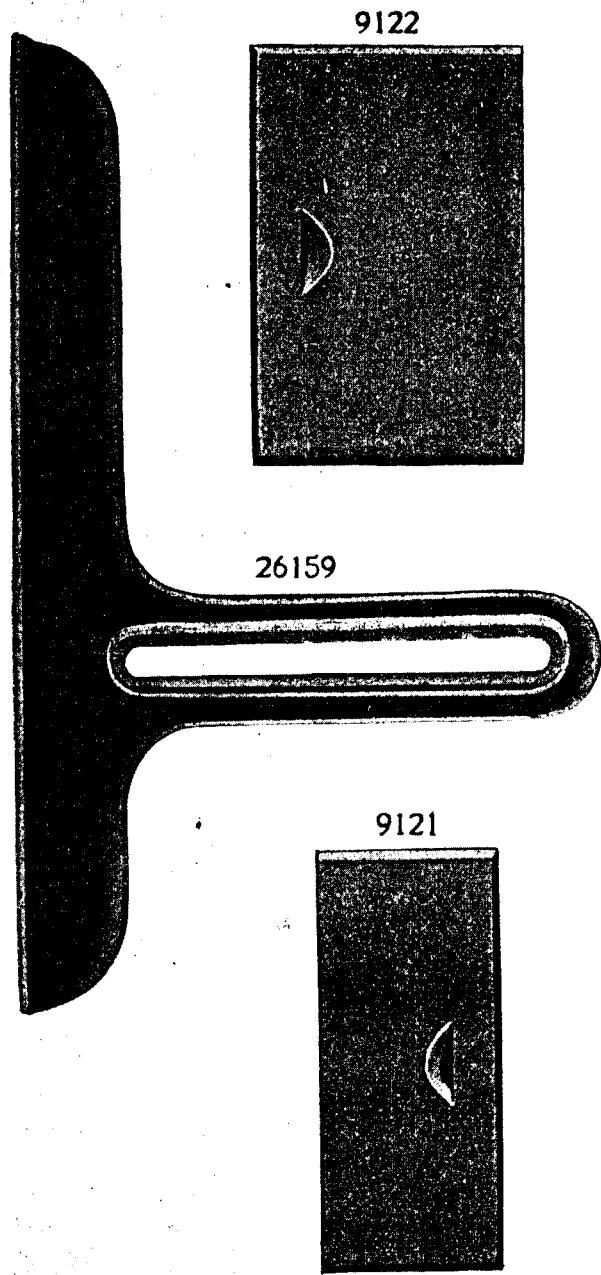


PLATE 7270—FULL SIZE

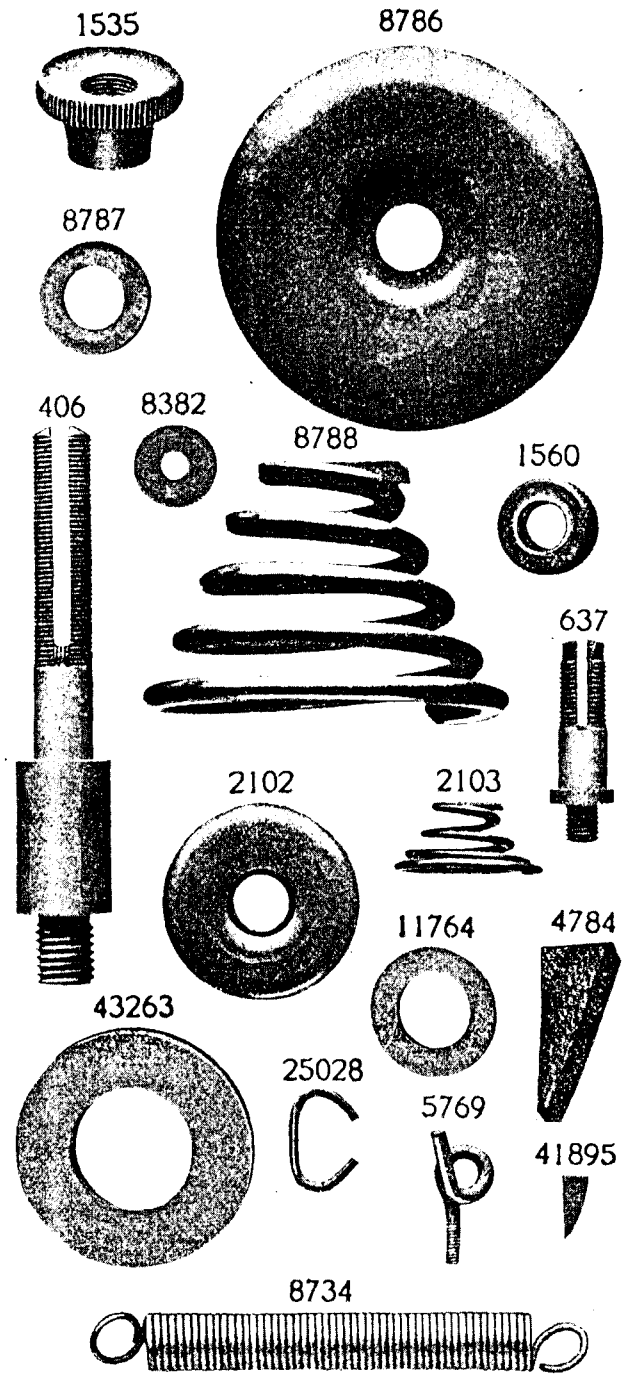


PLATE 7271—FULL SIZE

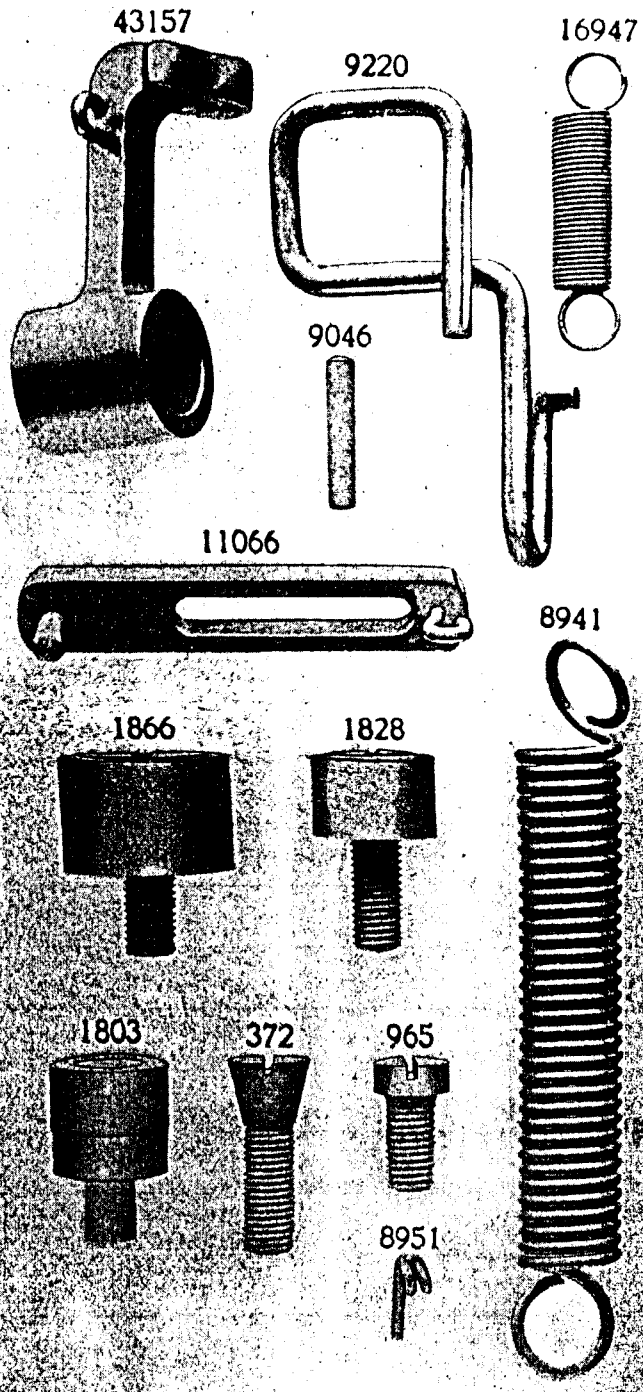


PLATE 7272—FULL SIZE

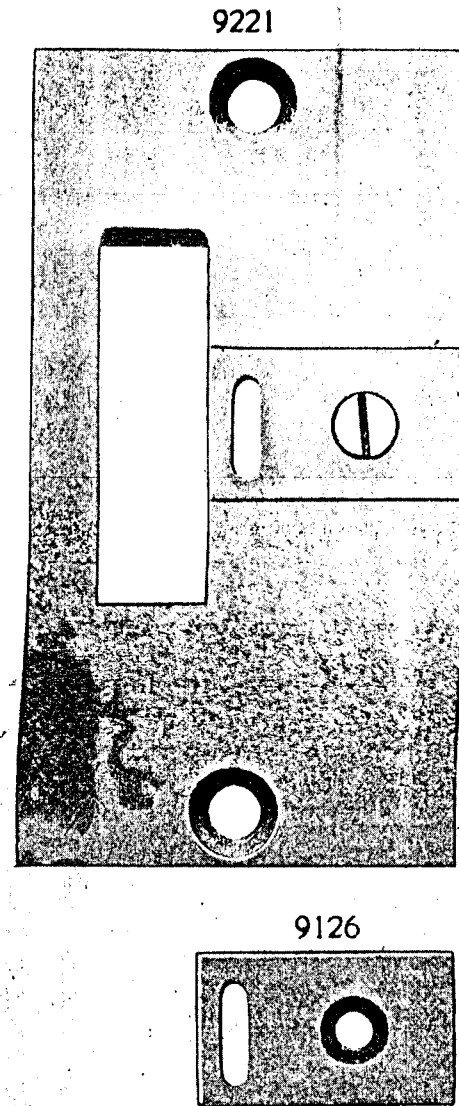


PLATE 7273—ONE-HALF SIZE

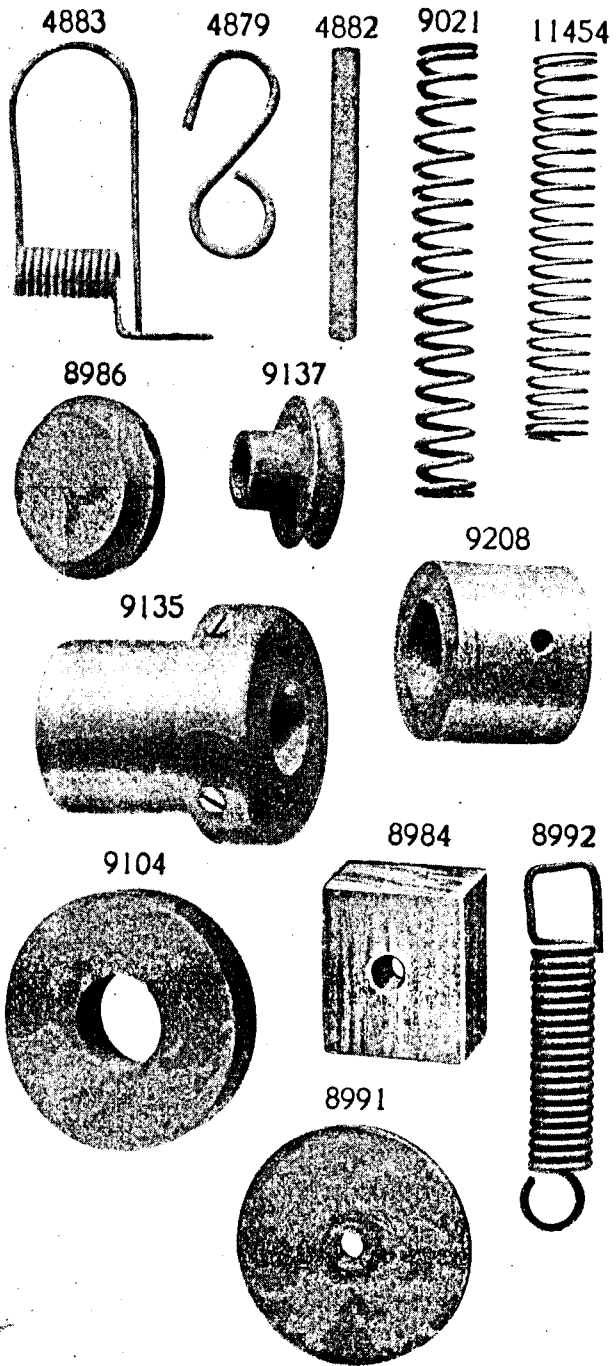


PLATE 7274—FULL SIZE

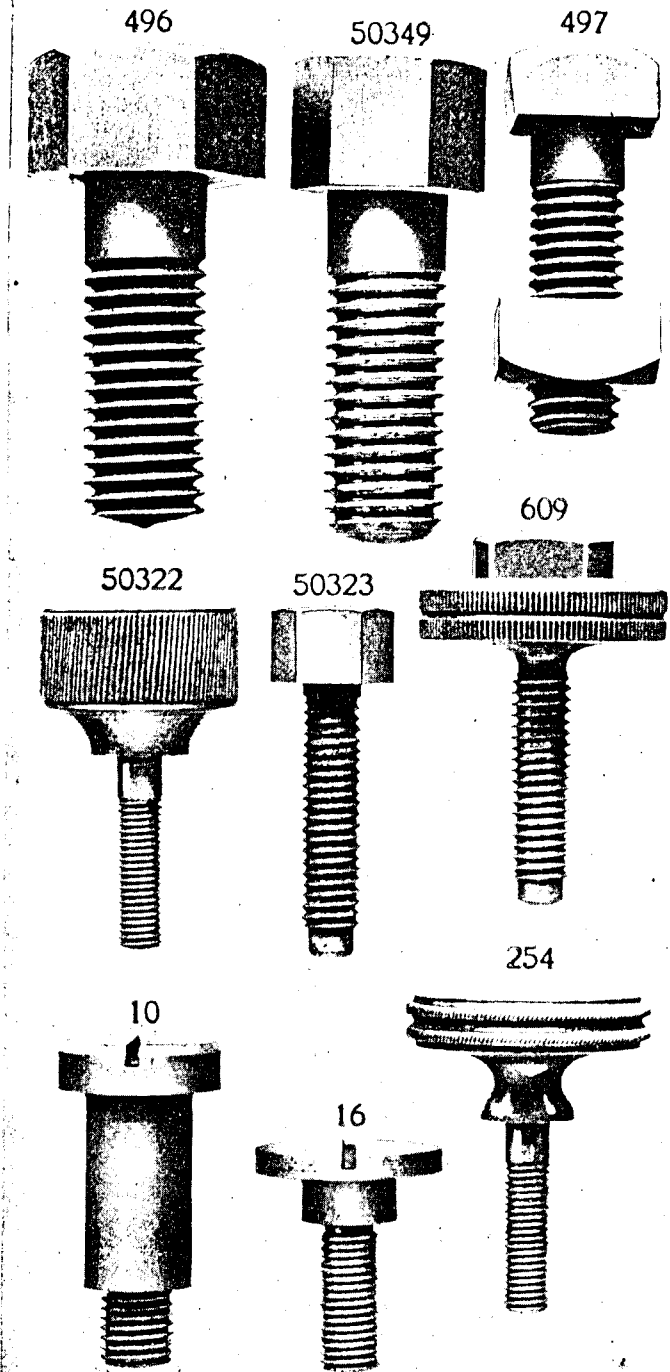


PLATE 7275—FULL SIZE

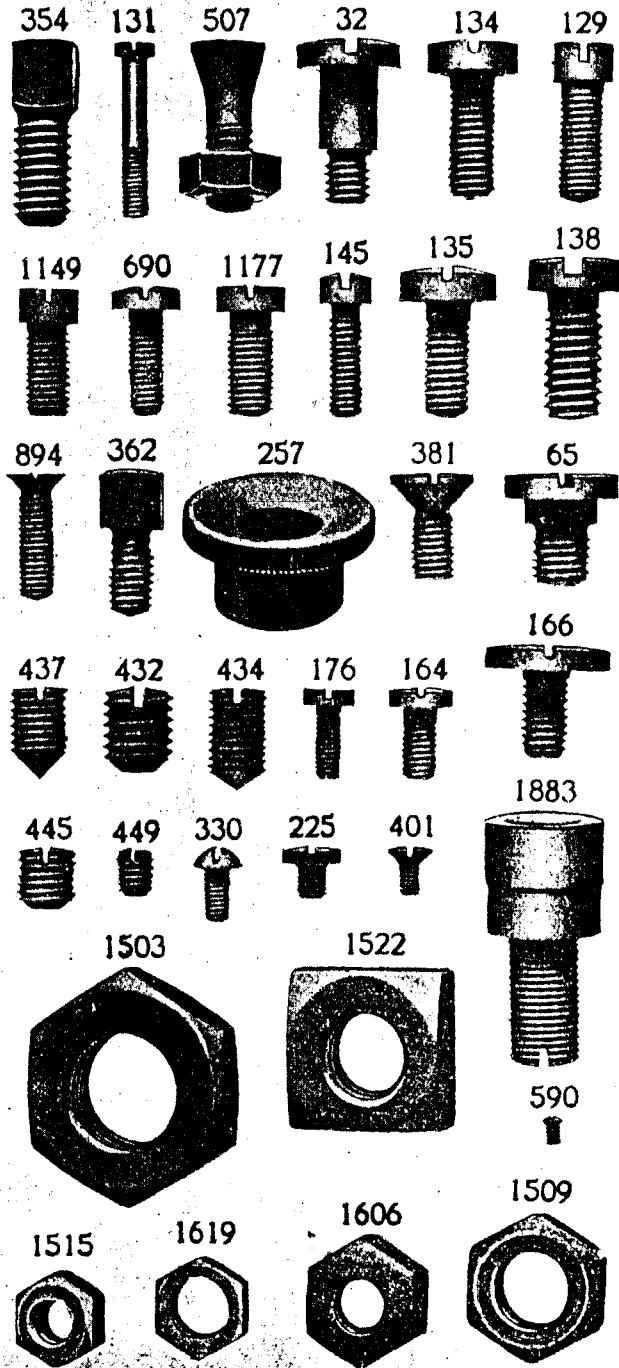


PLATE 7276—FULL SIZE

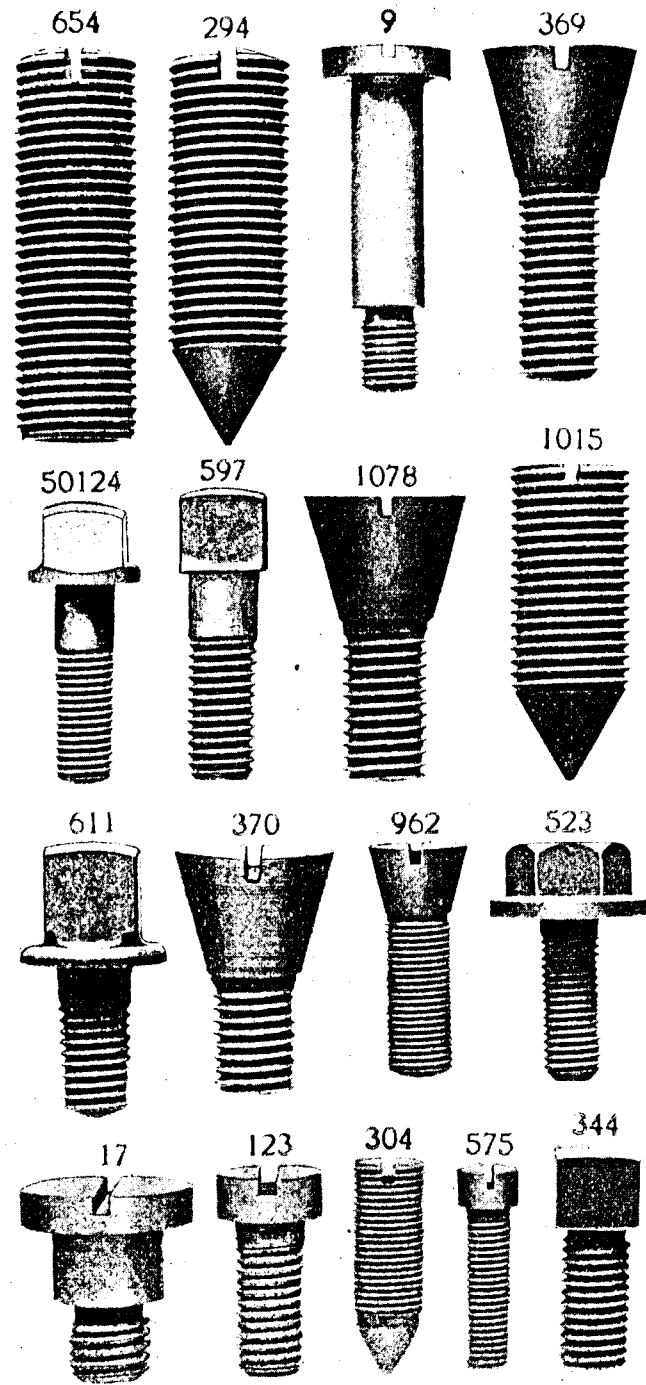
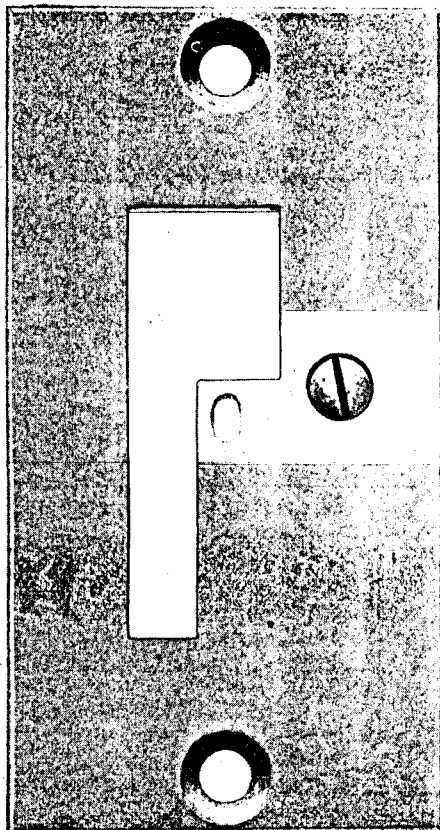
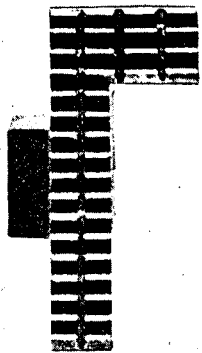


PLATE 7277—FULL SIZE

9230



8995



9231

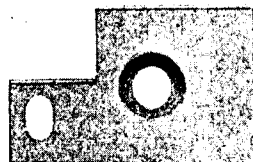
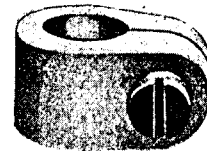


PLATE 7278—FULL SIZE

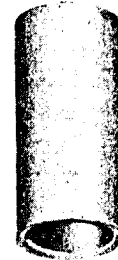
9244



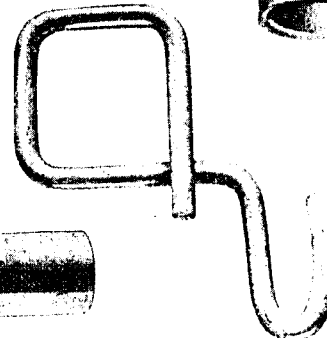
9243



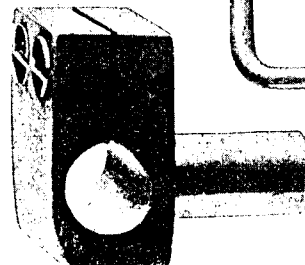
9239



9132



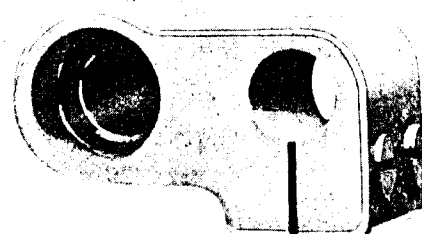
9246



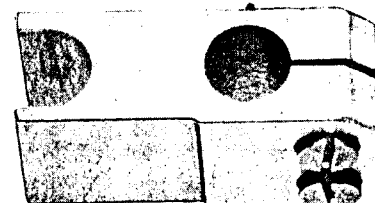
64003



9242



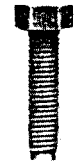
9240



19079



50364



1547



PLATE 7279—FULL SIZE

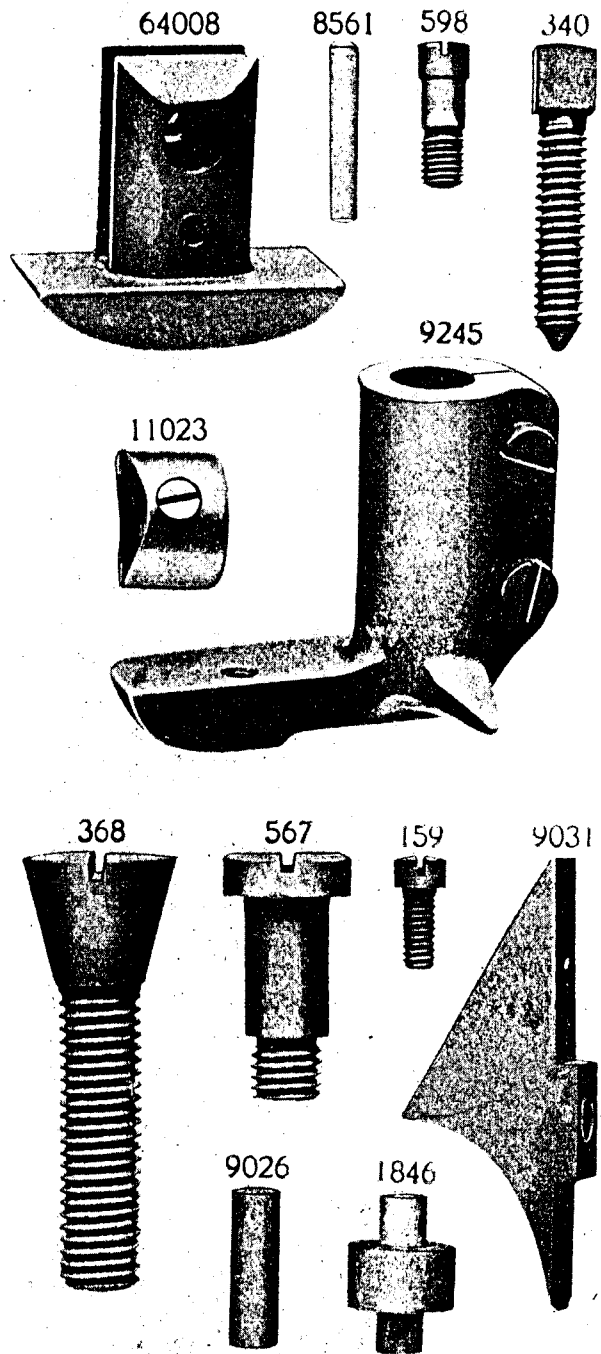


PLATE 7280—ONE-HALF SIZE

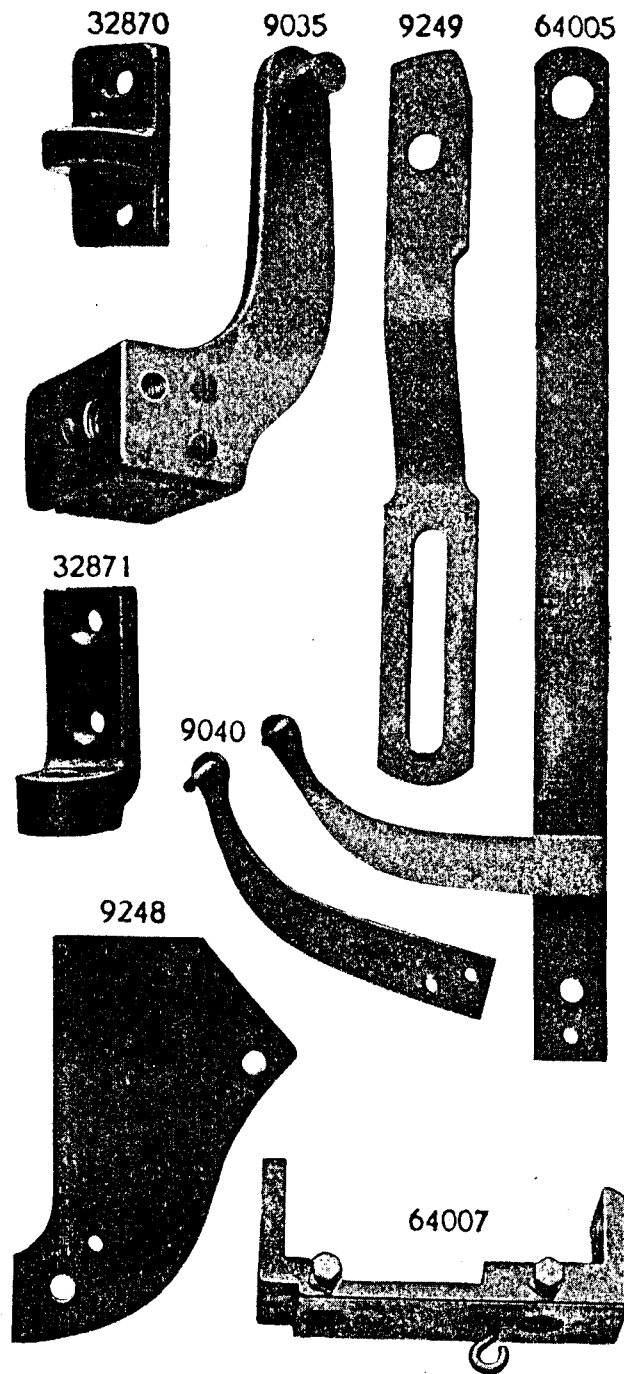
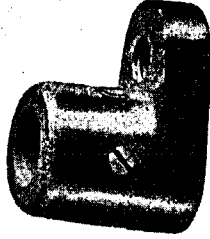
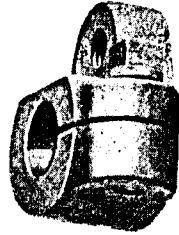


PLATE 7281—ONE-HALF SIZE

9002



9229



64002

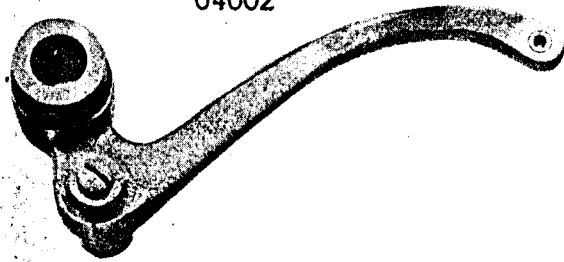
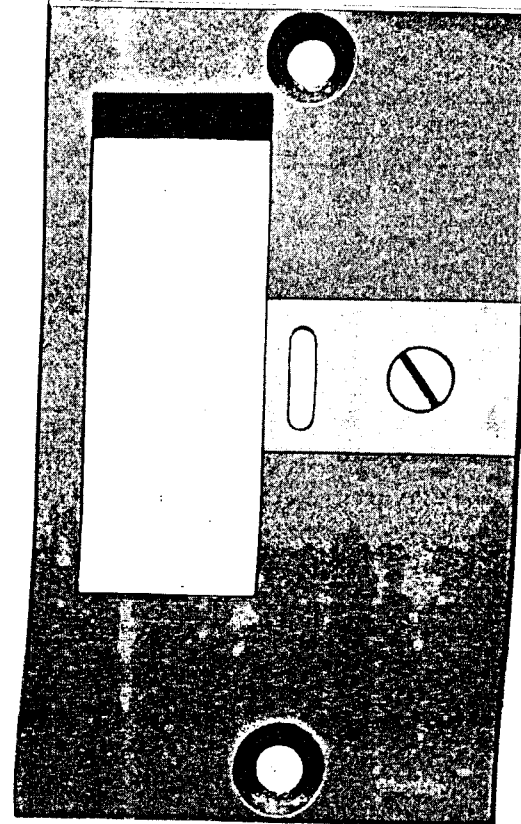


PLATE 7282—FULL SIZE

64004



9126

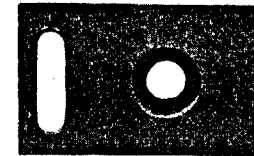
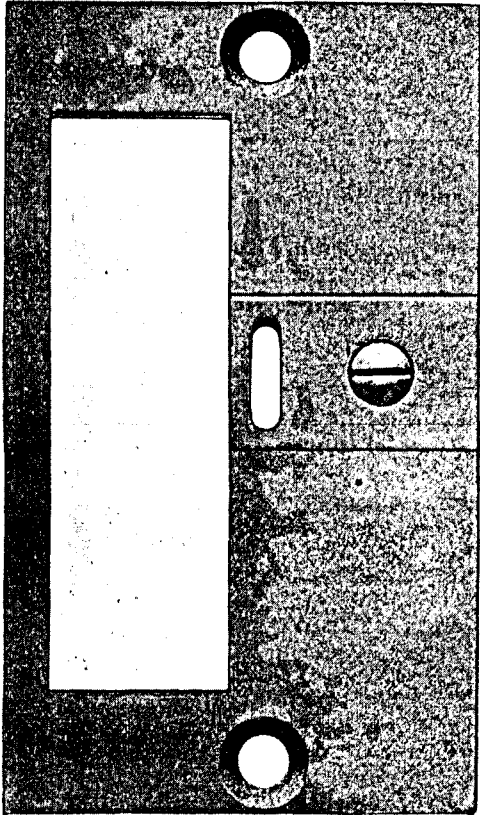
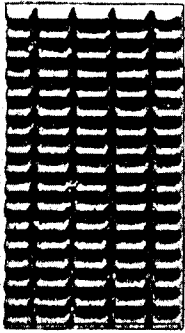


PLATE 7283—FULL SIZE

64018



64012



9126

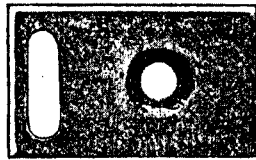
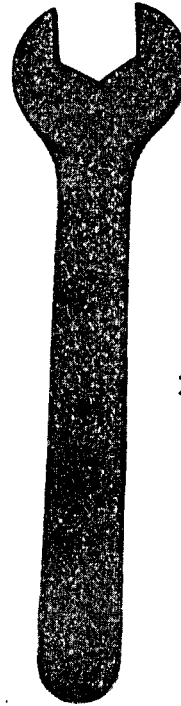


PLATE 7284—ONE-HALF SIZE

9155



8911



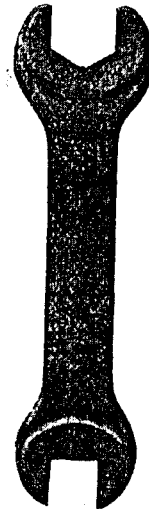
43184



23535



8910



8908



25200



8909



PLATE 7285—ONE-FOURTH SIZE

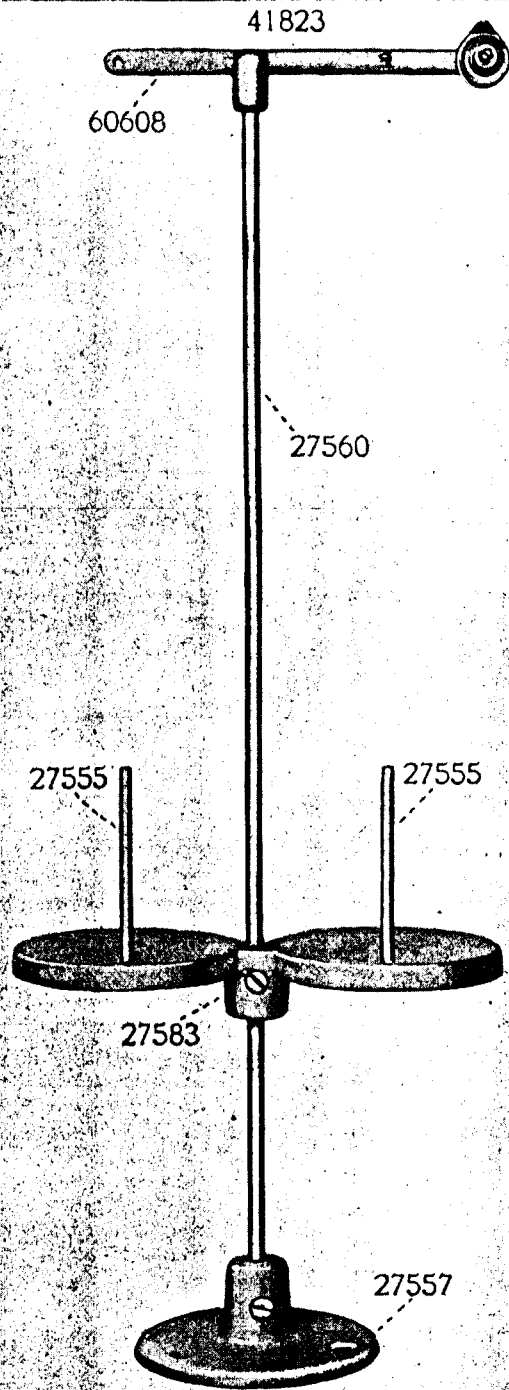


PLATE 7286—FULL SIZE

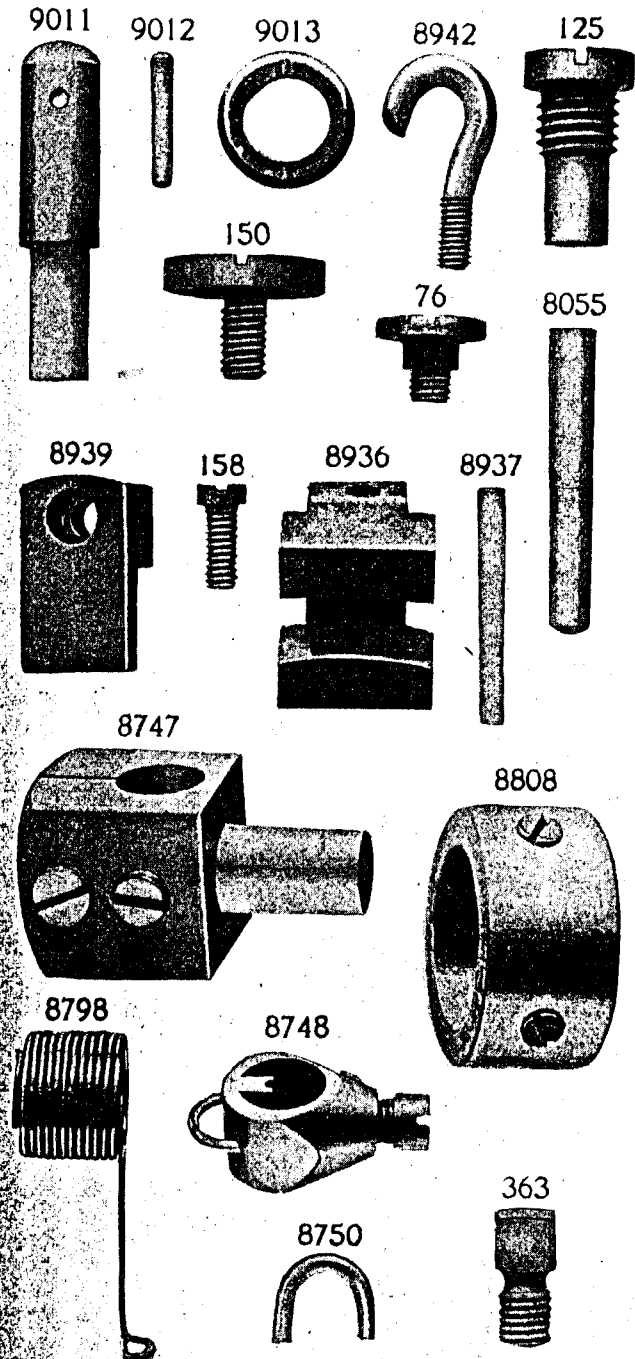


PLATE 7287—ONE-NINTH SIZE

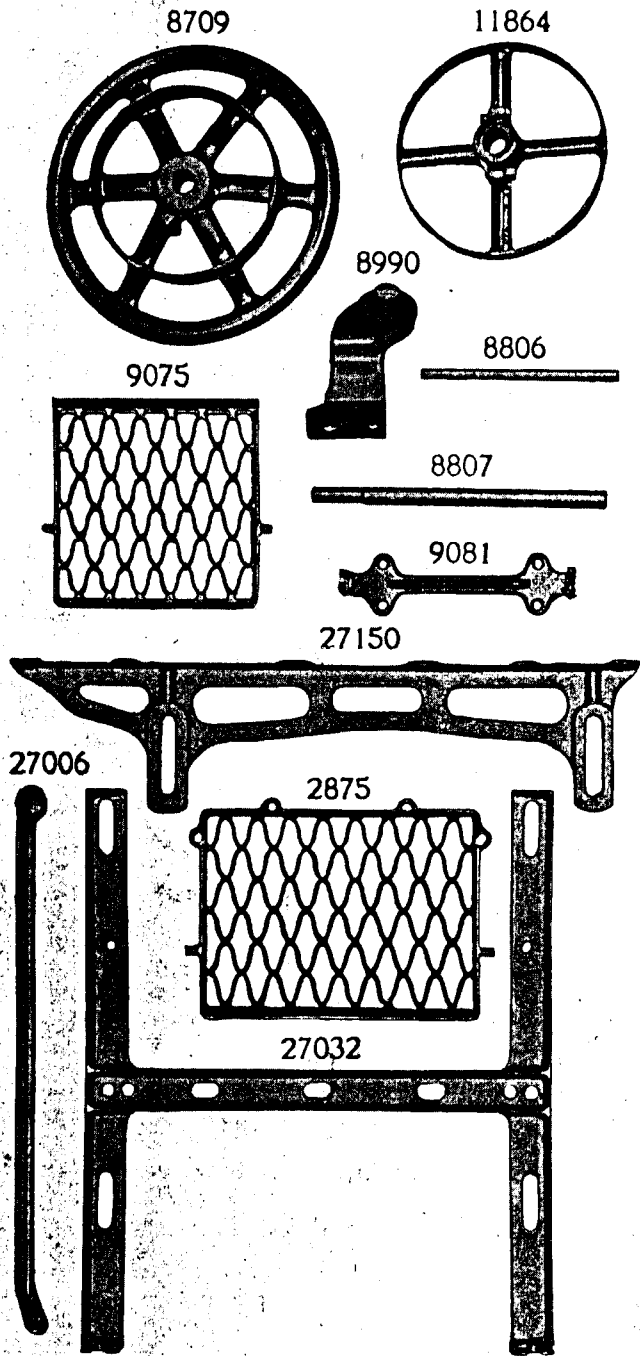


PLATE 7288—FULL SIZE

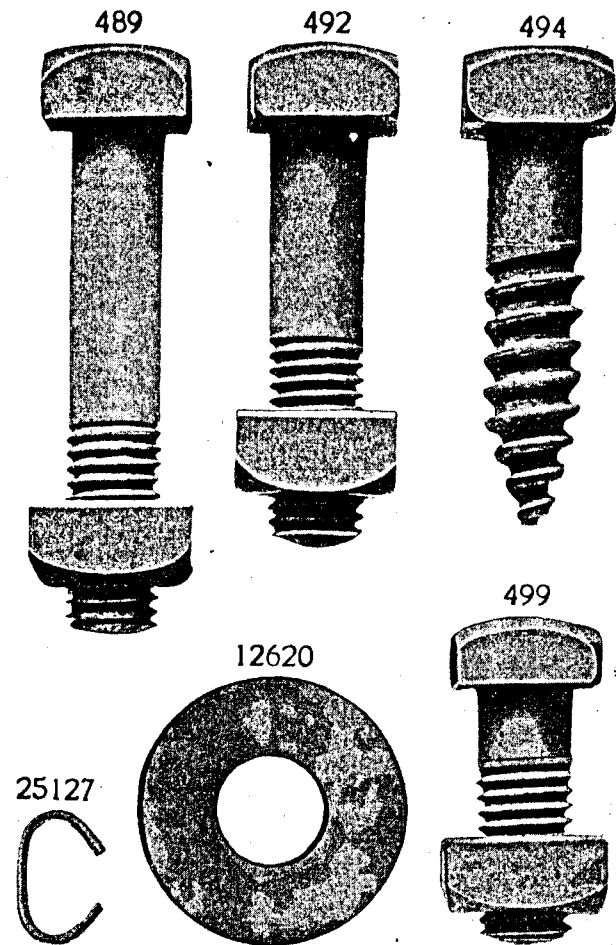


PLATE 7289—ONE-FOURTH SIZE

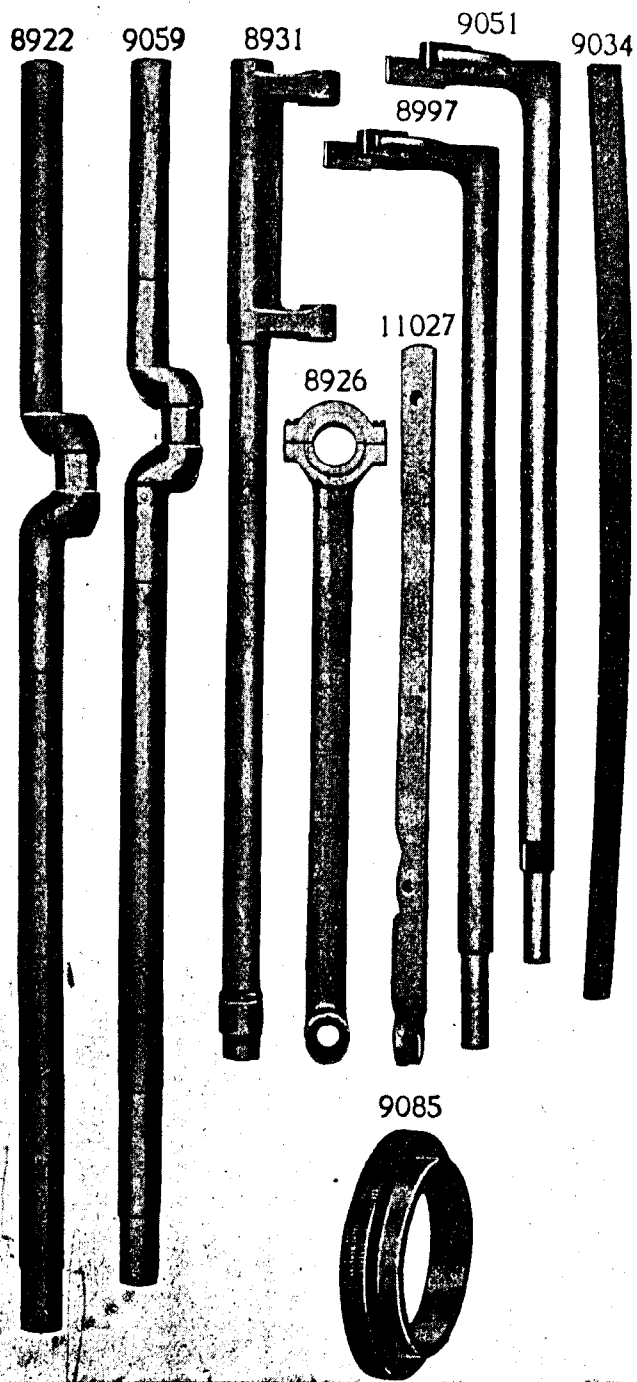


PLATE 7290—ONE-HALF SIZE

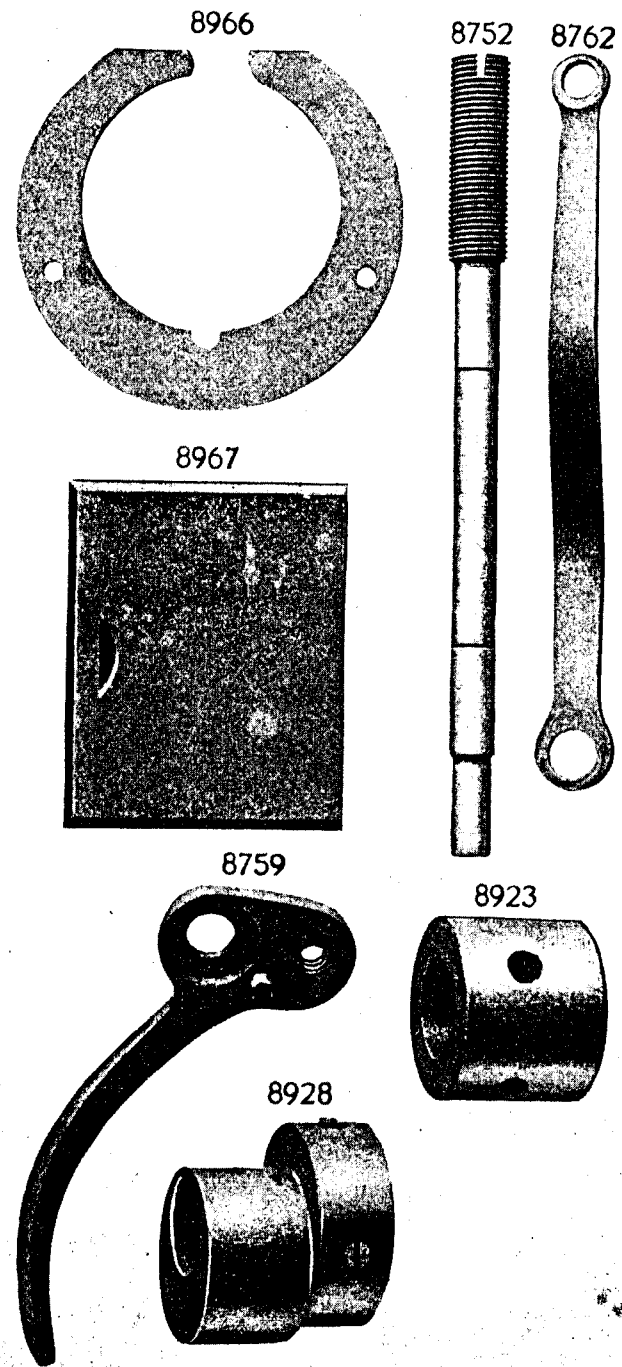


PLATE 7291—ONE-HALF SIZE

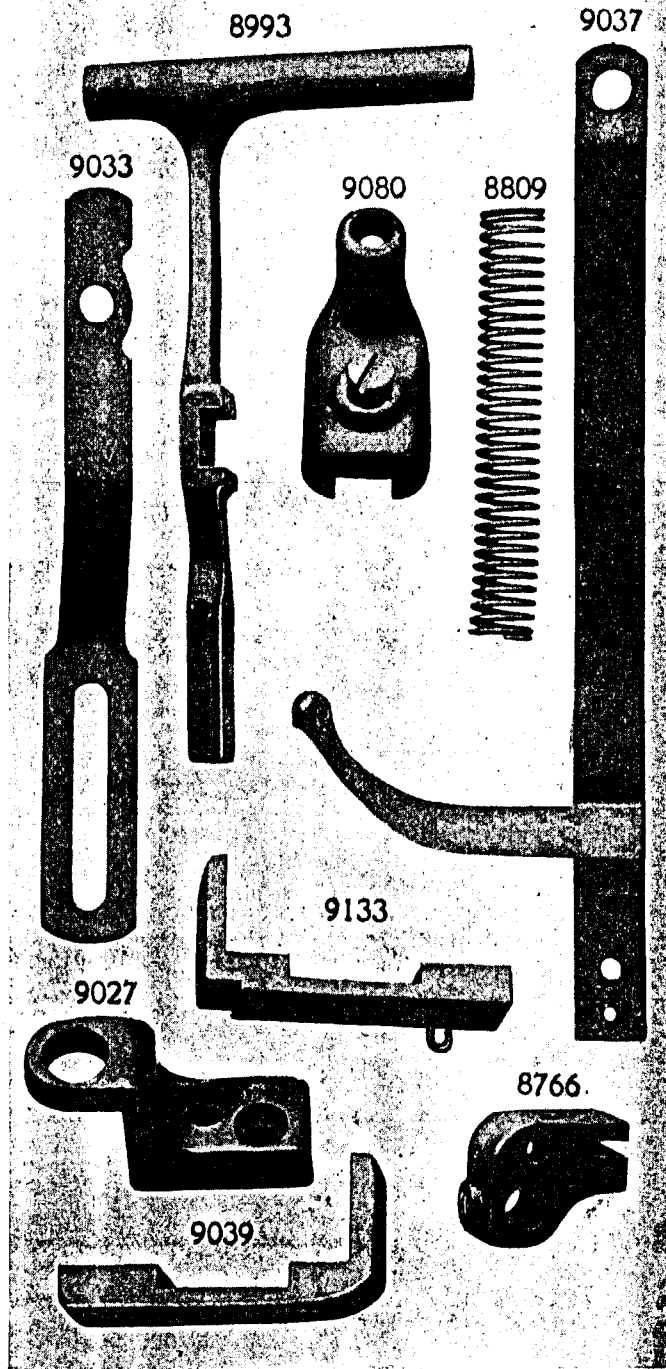


PLATE 7292—FULL SIZE

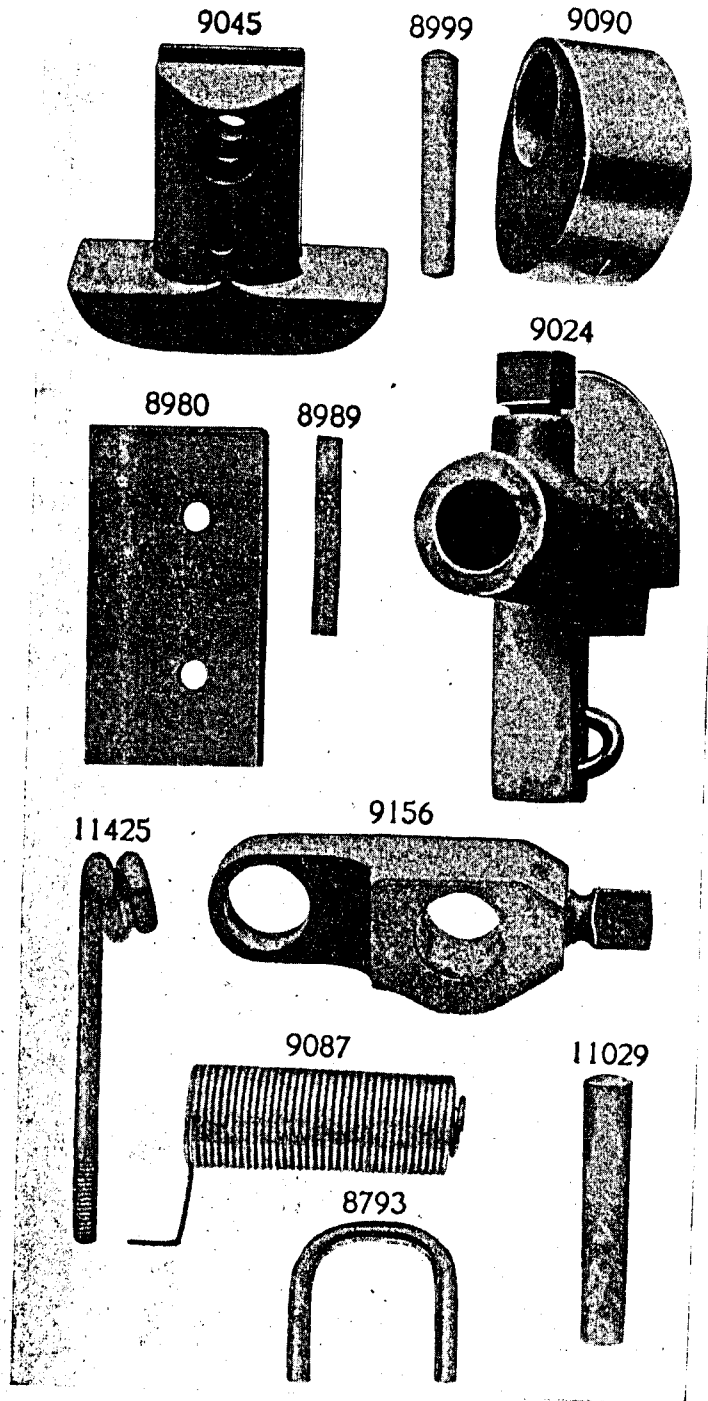
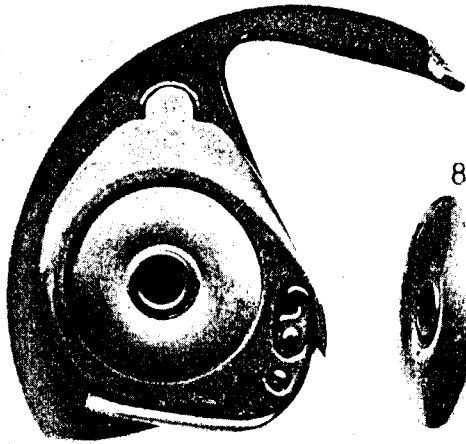


PLATE 7293—FULL SIZE

8969



742



8970



8976



8973



9320



9200



8975



8977



459



335

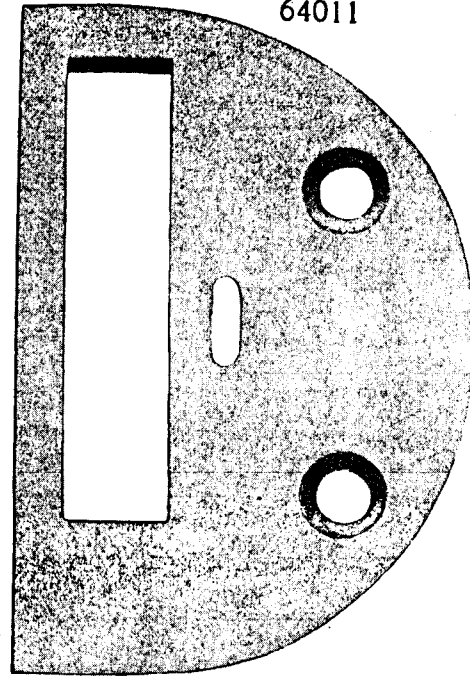


8974



PLATE 7294—FULL SIZE

64011



9205

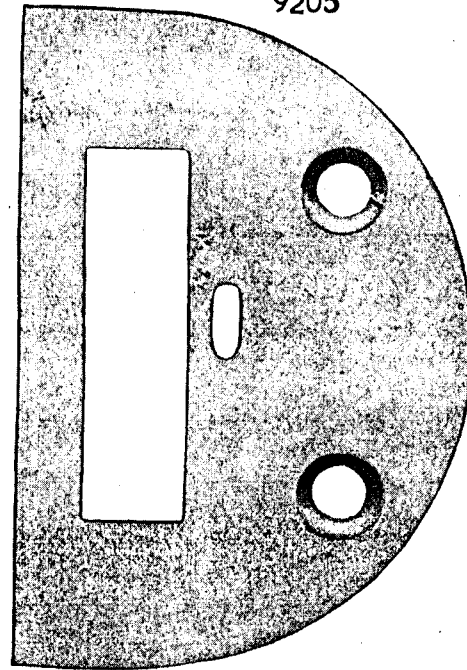


PLATE 7295—FULL SIZE

9003

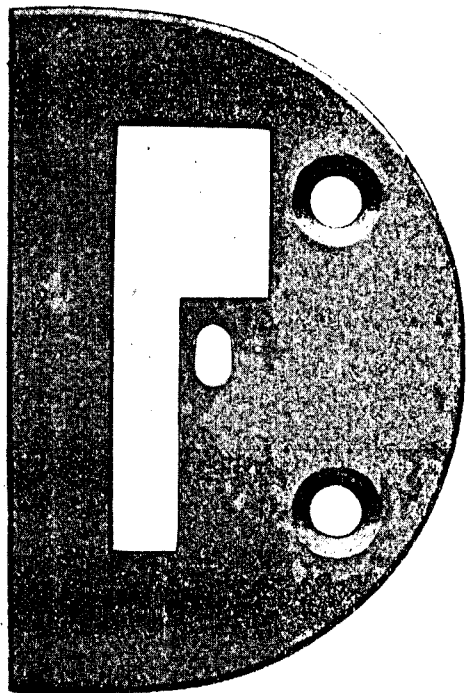
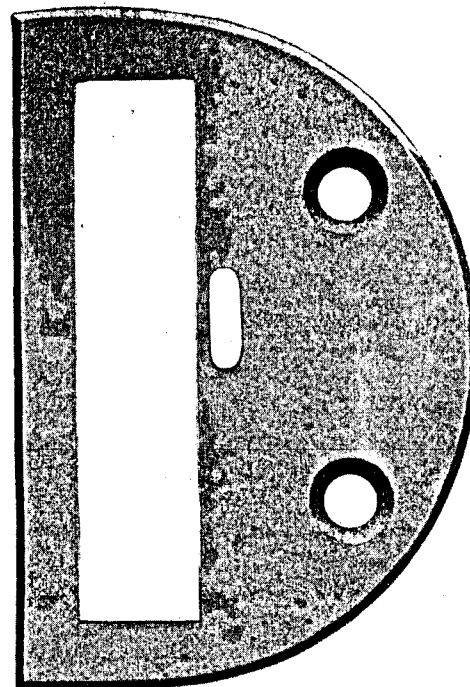


PLATE 7296—FULL SIZE

9036



9049

