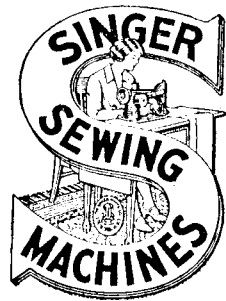


SINGER
61W52,W72,W84,W154

LIST OF PARTS



MACHINES

Nos. 61w52, 61w72, 61w84
and 61w154

THE SINGER MANUFACTURING COMPANY

INDEX

	PAGE
ACCESSORIES	31
BINDERS	43
BOBBIN WINDER	31
CORD COVERING ATTACHMENT	48
CORDERS	46
FEED DOGS	35
FOLDERS	49
HEMMERS	52
KNEE LUTTER PARTS	32, 33
MACHINE No. 61w52	7
" " 61w72	14
" " 61w84	22
" " 61w154	30
NUMERICAL LIST OF PARTS	61
PLATELTER	57
PRESSER FEET	36
RIBBON REELS	60
RUFFLER	59
THROAT PLATES	40
WOOD BASE	60

Instructions for Ordering

In ordering from this list, use **ONLY** the **PART** number in the **FIRST** column.

The number stamped on a Sewing Machine Part is the number of the Single Part only, except when the part includes Set Screws, Clamping Screws, Studs and Rollers Spun on, Small Wires riveted, or Parts soldered together, etc., which it is necessary to furnish in combination.

Every combination of parts sent out has its specific number which, although not stamped on Parts (except in above cases) must be used when ordering the combination.

Each number always indicates the **SAME PART** in whatever list it appears, or for whatever Machine.

The letters after some of the numbers indicate the style of finish only, as follows:

- A. Hardened, Polished and Plated.
- B. Polished and Plated.
- C. Hardened only.
- D. Polished only.
- E. Soft, not polished.
- F. Hardened and Polished.
- H. Blued.

These letters **MUST BE USED** when they appear in the list and **AFTER** the number, as in the list.

In this series

- 200001 to 201500 are Screw Numbers.
- 201501 to 201800 are Nut Numbers.
- 201801 to 202000 are Roller Numbers.
- 202001 and upward are numbers of Machine Parts.

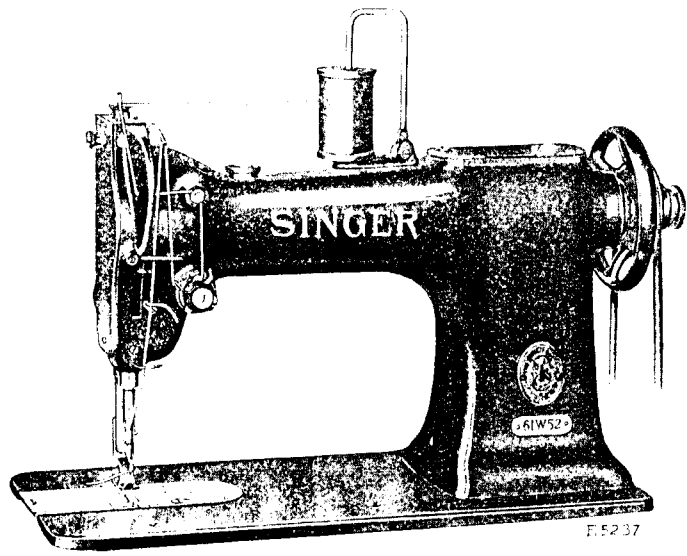
The figures in the second column refer only to the plate in which the illustration of the part is shown and are **NOT TO BE USED** in ordering.

Two or more numbers over a cut indicate that the difference between such parts is not visible in an illustration.

Parts marked with an asterisk (*) are furnished only when repairs are made at the factory.

LIST OF PARTS COMPLETE

FOR



MACHINE No. 61w52

For Shirts, Corsets, Underwear, Shirt Waists, Flannels, Etc.

No.	Plate	Name
*207079		Arm
202247	10667	" Cap
200278H	10244	" " Screw
202248	10244	" " Washer
204235	13375	" Position Pin (2)
200010E	10245	" Screw (3)
202005	10245	" " Washer (3)
202249	13351	" Shaft with 200357E and 203100
202243	13351	" " Bushing (back) with
		202244
207080	13376	Arm Shaft Bushing (front) with
		202244
200502E	10246	Arm Shaft Bushing (front) Oil
		Packing Thumb Screw
202244	-	Arm Shaft Bushing Oil Packing
		(wick)

Parts for Machine No. 61w52

No.	Plate	Name
200338c	10244	Arm Shaft Bushing Set Screw (2)
202530	13351	" " Connection Belt
202252	10244	" " " " Pulley
		with 200327c, 200602e and two 202253
200602e	10244	Arm Shaft Connection Belt Pulley Position Screw
200327c	10244	Arm Shaft Connection Belt Pulley Set Screw
202253	10244	Arm Shaft Connection Belt Pulley Spring Flange
203100	---	Arm Shaft Oil Packing (wick)
200357E	10244	" " " " Stop Screw
202255	13351	Balance Wheel (belt groove 2 1/2 in. diam.) with 200328c and 200335c
200328c	10244	Balance Wheel Position Screw
200335c	10244	" " Set Screw
*207081	---	Bed
207082	13376	" Plate (back)
200577H	10245	" " " Screw (2)
207083	13376	" Slide (front)
202265	11671	Bobbin
*202806	---	" Case
202267	11671	" Latch
*202056	---	" " Pin
202269	11671	" " Plunger
202270	11671	" " Spring
202716	11671	" " Tension Spring
200984c	11671	" " " " Regulating Screw
200594c	11671	Bobbin Case Tension Spring Screw
202533	11671	Bobbin Case complete, Nos. 200594c, 200984c, 202056, 202267, 202269, 202270, 202716 and 202806
200459d	13375	Cloth Guide Thumb Screw
202274	10667	Face Plate
202135	10245	" " Position Pin
200462e	10245	" " Thumb Screw
202275	10667	Feed Bar
200641c	10246	" " Hinge Screw (driving)
201522E	10246	" " " " Nut
202276	10245	" " Slide Block
202298	10245	" " " " Crank with 200038c
203124	---	Feed Bar Slide Block Crank 202298 with 200205E, 201518E and 202276
200038c	10245	Feed Bar Slide Block Crank Pinch Screw

Parts for Machine No. 61w52

No.	Plate	Name
200205E	10245	Feed Bar Slide Block Hinge Screw
201518E	10245	" " " " " " " " Nut
202282	10913	Feed Dog
200106E	10245	" " Screw (2)
202297	10667	" Driving Connection with 200054E and 202277
202298	10245	Feed Driving Connection Crank with 200038c
200038c	10245	Feed Driving Connection Crank Pinch Screw
200545c	10245	Feed Driving Connection Hinge Screw
201518E	10245	Feed Driving Connection Hinge Screw Nut
202277	---	Feed Driving Connection Oil Packing (wick)
200054E	10246	Feed Driving Connection Pinch Screw
202300	10246	Feed Driving Eccentric Regulating Bracket
203131	---	Feed Driving Eccentric Regulating Bracket 202300 with 202252, two each 201014c and 201525E
201014c	10245	Feed Driving Eccentric Regulating Bracket Hinge Screw
201525E	10245	Feed Driving Eccentric Regulating Bracket Hinge Screw Nut
202301	10246	Feed Driving Eccentric Regulating Bracket Plunger
202595	10246	Feed Driving Eccentric Regulating Bracket Plunger Spring
200607c	10246	Feed Driving Eccentric Regulating Bracket Plunger Spring Stop Screw
201014c	10245	Feed Driving Eccentric Regulating Bracket Stop Screw
201525E	10245	Feed Driving Eccentric Regulating Bracket Stop Screw Nut
200429c	10246	Feed Driving Eccentric Regulating Screw
200383c	10246	Feed Driving Eccentric Regulating Screw Check Screw
202303	13377	Feed Driving Rock Shaft
206860	---	" " " " 202303 with 200641c, 201522E and 202275
203121	---	Feed Driving Rock Shaft 206860 with 202282 and two 200106E

No.	Plate	Name
202305	10245	Feed Driving Rock Shaft Center (2)
200043c	10246	" " " " " Set
		Screw (2)
202306	10667	Feed Lifting Connection with
		200054e and 202277
202307	10246	Feed Lifting Connection Eccentric
		with 200382c and 200437c
200437c	10246	Feed Lifting Connection Eccentric
		Position Screw
200382c	10359	Feed Lifting Connection Eccentric
		Set Screw
200545c	10245	Feed Lifting Connection Hinge
		Screw
201518e	10245	Feed Lifting Connection Hinge
		Screw Nut
202277	-----	Feed Lifting Connection Oil Pack-
		ing (wick)
200054e	10246	Feed Lifting Connection Pinch
		Screw
202308	13377	Feed Lifting Rock Shaft
202305	10245	" " " " Center (2)
200043c	10246	" " " " " Set
		Screw (2)
202310	13376	Feed Regulating Spindle with
		202311, 202443 and 202619
*202311	-----	Feed Regulating Spindle Head
202443	10244	" " " " Pin
202619	13375	" " " " Posi-
		tion Pin
*244010	-----	Hook (sewing)
244011	13377	" 244010 with 200145c, 200596e,
		200614c, 202320, 203101, 206775,
		206852 and 244014
244012	-----	Hook and Bobbin Case complete,
		Nos. 202533 and 244011
244013	13375	Hook Counter Balance with 200444c
200444c	13375	" " " " Position Screw
206852	13375	" Gib
200614c	11671	" " Hinge Screw
200596e	11671	" " Screw
203101	-----	" Oil Wick
*202320	-----	" Shaft, 11 1/2 in. long
202321	10245	" " Bushing (back)
200346c	10245	" " " " Set Screw
202322	10245	" " " " (front)
200346c	10245	" " " " Set Screw
202323	10244	" " Connection Belt Pulley
		with 202324 and two 201018c
201018c	13375	Hook Shaft Connection Belt Pulley
		Set Screw

No.	Plate	Name
202324	10244	Hook Shaft Connection Belt Pulley
		Spring Flange
202260	-----	Hook Shaft Oil Packing (wick) (2)
206775	11671	" " Pin
244014	13375	" Washer
200145c	11671	" " Screw
237837	13377	Knee Lifter Connection Lever
244035	-----	" " " " 237837
		with 202447, 244034 and two
		200262n
200262n	10248	Knee Lifter Connection Lever
		Hinge Screw
202417	13376	Knee Lifter Connection Lever Lift-
		ing Rod with 202302
202302	10248	Knee Lifter Connection Lever Lift-
		ing Rod Cotter Pin
244034	13377	Knee Lifter Lifting Lever
200262n	10248	" " " " Hinge
		Screw
202326	10248	Needle Bar with 200141e
202327	10248	" " Bushing
203123	-----	" " " 202327 with 202326
200352c	10248	" " " Set Screw
202331	10248	" " Connecting Link
236073	13375	" " " " Oil
		Guard
200161b	10247	Needle Bar Connecting Link Oil
		Guard Screw
202333	10248	Needle Bar Connecting Link Stud
		with 202254
202254	-----	Needle Bar Connecting Link Stud
		Oil Packing (wick)
200374c	13375	Needle Bar Connecting Link Stud
		Set Screw
*206891	-----	Needle Bar Connecting Stud
202329	10248	" " " " 206891
		with 200086c and 202330
202330	-----	Needle Bar Connecting Stud Oil
		Packing (wick)
200086c	10248	Needle Bar Connecting Stud Pinch
		Screw
202328	13376	Needle Bar Crank with 200335c,
		200428c, 202333 and two 200374c
203117	-----	Needle Bar Crank 202328 with
		202329, 202331 and 202398 to
		202400
203172	10248	Needle Bar Crank Friction Washer
200428c	10248	" " " Position Screw ..
200335c	10244	" " " Set Screw
200141e	10248	" Set Screw

No.	Plate	Name
244033	---	Presser Bar (hollow)
202335	10667	" " 244033 with 200074r...
207072	13375	" " Bushing
200352c	10248	" " " Set Screw
202339	13375	" " Lifter
200653c	13375	" " " Hinge Screw ...
244004	13375	" " Lifting Releasing Lev- er Bracket
200260D	13375	Presser Bar Lifting Releasing Lev- er Bracket Guide Screw
206608	13375	Presser Bar Lifting Releasing Lev- er Bracket Spring
202337	13375	Presser Bar Position Guide
202338	13375	" " " " Lever with 200086r
200086r	10248	Presser Bar Position Guide Lever Pinch Screw
200352c	10248	Presser Bar Position Guide Set Screw
202343	13378	Presser Bar Spring (light)
202346	13378	" " " Stop Rod
200492B	13378	" " Thumb Screw (pres- sure regulating)
200475B	13378	Presser Bar Thumb Screw Thumb Set Screw
202355	13378	Presser Bar Thumb Screw Thumb Set Screw Packing (brass)
202418	10929	Presser Foot
200074r	13378	" " Screw
202068	12153	Spool Holder Base
200575H	13378	" " " Screw
204296	12153	" " Wire
200079H	13378	" " " Hinge Screw ...
204297	12153	Spool Holder complete, Nos. 200079H, 202068 and 204296
202397	13378	Take-up (auxiliary)
200842E	13378	" " Screw
202398	10247	" Lever
202399	10247	" " Driving Stud with 202277
202277	----	Take-up Lever Driving Stud Oil Packing (wick)
202400	10247	Take-up Lever Hinge Stud with 202423
202423	----	Take-up Lever Hinge Stud Oil Packing (wick)
200383c	10246	Take-up Lever Hinge Stud Set Screw

No.	Plate	Name
202401	10247	Take-up Lever Oiling Felt
200132E	10247	" " " " Screw ..
244007	10247	Tension Disc (back)
244008	10247	" " (front)
202404	10247	" Release Plunger
202405	10247	" " Washer
202407	10881	" Spring
200625r	10247	" Stud with 204925
200061c	13378	" Set Screw
204925	13378	" Washer
201572B	10881	" Thumb Nut
202409	10252	Tension complete, Nos. 200625r, 201572B, 202405, 202407, 202410, 244007 and 244008
202410	10252	Thread Controller Spring
202411	10252	" " " Stop
200132E	10247	" " " " Screw ..
202413	10252	" Guide
202414	10252	" "
202415	10252	" "
202417	10252	" "
200582H	10252	" " Screw
200355H	10252	" " Set Screw
200368H	13378	" " " "
202091	10252	" Retainer Sleeve
202092	10252	" " Spring
204058	10252	" " Stud
200368H	13378	" " " Set Screw
204059	----	Thread Retainer complete, Nos. 202091, 202092 and 204058
202818	13354	Throat Plate, 50 needle hole, for needle sizes 14 and 15, with 202534, 202619 and two 200583H...
202534	10390	Throat Plate Bobbin Case Stop
202619	13375	" " " " "
		Position Pin
200583H	13378	Throat Plate Bobbin Case Stop Screw
200577H	10245	Throat Plate Screw (2)

LIST OF PARTS COMPLETE
FOR
MACHINE No. 61w72

For Tuck Marking. Has Tuck Marker Operated
 by the Feed Lifting Rock Shaft

No.	Plate	Name
*207079	—	Arm
202247	10667	" Cap
200278H	10244	" " Screw
202248	10244	" " Washer
204235	13375	" Position Pin
200010E	10245	" Screw
202005	10245	" " Washer
202249	13351	" Shaft with 200357E and 203100
202243	13351	" " Bushing (back) with 202244
200502B	10246	Arm Shaft Bushing Oil Packing Thumb Screw
202244	—	Arm Shaft Bushing Oil Packing (wick)
200338C	10244	Arm Shaft Bushing Set Screw ...
202530	13351	" " Connection Belt
202252	10244	" " " " Pulley with 200327C, 200602E and two 202253
200602E	10244	Arm Shaft Connection Belt Pulley Position Screw
200327C	10244	Arm Shaft Connection Belt Pulley Set Screw
202253	10244	Arm Shaft Connection Belt Pulley Spring Flange
203100	—	Arm Shaft Oil Packing (wick) ...
200357E	10244	" " " " Stop Screw...
202255	13351	Balance Wheel (belt groove 2¼ in. diam.) with 200328C and 200335C
200328C	10244	Balance Wheel Position Screw ...
200335C	10244	" " Set Screw
*207081	—	Bed
207083	13376	" Slide (front)
202265	11671	Bobbin
*202806	—	" Case
202267	11671	" " Latch
*202056	—	" " " Pin
202269	11671	" " " Plunger

No.	Plate	Name
202270	11671	Bobbin Case Latch Spring
202716	11671	" " Tension Spring
200984C	11671	" " " " Regulat- ing Screw
200594C	11671	Bobbin Case Tension Spring Screw
202533	11671	Bobbin Case complete, Nos. 200594C, 200984C, 202056, 202267, 202269, 202270, 202716 and 202806
200459D	13375	Cloth Guide Thumb Screw
202274	10667	Face Plate
202135	10245	" " Position Pin
200462B	10245	" " Thumb Screw
202275	10667	Feed Bar
200641C	10246	" " Hinge Screw (driving)..
201522E	10246	" " " " Nut
202276	10245	" " Slide Block
202298	10245	" " " " Crank with 200038C
203124	—	Feed Bar Slide Block Crank 202298 with 200205E, 201518E and 202276
200038C	10245	Feed Bar Slide Block Crank Pinch Screw
200205E	10245	Feed Bar Slide Block Hinge Screw
201518E	10245	" " " " " " " Nut
202294	10912	Feed Dog
200106E	10245	" " Screw (2)
202297	10667	" Driving Connection with 200054E and 202277
202298	10245	Feed Driving Connection Crank with 200038C
200038C	10245	Feed Driving Connection Crank Pinch Screw
200545C	10245	Feed Driving Connection Hinge Screw
201518E	10245	Feed Driving Connection Hinge Screw Nut
202277	—	Feed Driving Connection Oil Pack- ing (wick)
200054E	10246	Feed Driving Connection Pinch Screw
202300	10246	Feed Driving Eccentric Regulating Bracket
203134	—	Feed Driving Eccentric Regulating Bracket 202300 with 202252, two each 201014C and 201525E
201014C	10245	Feed Driving Eccentric Regulating Bracket Hinge Screw
201525E	10245	Feed Driving Eccentric Regulating Bracket Hinge Screw Nut

No.	Plate	Name
202301	10246	Feed Driving Eccentric Regulating Bracket Plunger
202595	10246	Feed Driving Eccentric Regulating Bracket Plunger Spring
200607c	10246	Feed Driving Eccentric Regulating Bracket Plunger Spring Stop Screw
201014c	10245	Feed Driving Eccentric Regulating Bracket Stop Screw
201525E	10245	Feed Driving Eccentric Regulating Bracket Stop Screw Nut
200429c	10246	Feed Driving Eccentric Regulating Screw
200383c	10246	Feed Driving Eccentric Regulating Screw Check Screw
202303	10365	Feed Driving Rock Shaft
206860	—	" " " " 202303 with 200641c, 201522E and 202275
203121	—	Feed Driving Rock Shaft 206860 with 202282 and two 200106E ..
202305c	10245	Feed Driving Rock Shaft Center (2)
200043c	10246	" " " " " Set Screw (2)
202306	10667	Feed Lifting Connection with 200054E and 202277
202307	10246	Feed Lifting Connection Eccentric with 200382c and 200437c
200437c	10246	Feed Lifting Connection Eccentric Position Screw
200382c	10359	Feed Lifting Connection Eccentric Set Screw
200545c	10245	Feed Lifting Connection Hinge Screw
201518E	10245	Feed Lifting Connection Hinge Screw Nut
202277	—	Feed Lifting Connection Oil Packing (wick)
200054E	10246	Feed Lifting Connection Pinch Screw
202308	13377	Feed Lifting Rock Shaft
202305c	10245	" " " " Center (2)
200043c	10246	" " " " " Set Screw (2)
202310	13376	Feed Regulating Spindle with 202311, 202443 and 202619
*202311	—	Feed Regulating Spindle Head ...
202443	10244	" " " " Pin
202619	13375	" " " " Position Pin

No.	Plate	Name
*244010	—	Hook (sewing)
244011	13377	" 244010 with 200145c, 200596E, 200614c, 202320, 203101, 206775, 206852 and 244014
244012	—	Hook and Bobbin Case complete, Nos. 202533 and 244011
244013	13375	Hook Counter Balance with 200444c
200444c	13375	" " " Position Screw
206852	13375	" Gib
200614c	11671	" " Hinge Screw
200596E	11671	" " Screw
203101	—	" Oil Wick
*202320	—	" Shaft, 11 ¹ / ₂ in. long
202321	10245	" " Bushing (back)
200346c	10245	" " " " Set Screw
202322	10245	" " " (front)
200346c	10245	" " " " Set Screw ..
202323	10244	" " Connection Belt Pulley with 202324 and two 201018c
201018c	13375	Hook Shaft Connection Belt Pulley Set Screw
202324	10244	Hook Shaft Connection Belt Pulley Spring Flange
202260	—	Hook Shaft Oil Packing (wick) (2)
206775	11671	" " Pin
244014	13375	" Washer
200145c	11671	" " Screw
237837	13377	Knee Lifter Connection Lever
244035	—	" " " " " 237837 with 202447, 244034 and two 200262n
200262n	10248	Knee Lifter Connection Lever Hinge Screw
202447	13376	Knee Lifter Connection Lever Lifting Rod with 202302
202302	10248	Knee Lifter Connection Lever Lifting Rod Cotter Pin
244034	13377	Knee Lifter Lifting Lever
200262n	10248	" " " " Hinge Screw
202326	10248	Needle Bar with 200141E
202327	10248	" " Bushing
203123	—	" " " 202327 with 202326
200352c	10248	Needle Bar Bushing Set Screw ...
202331	10248	" " Connecting Link
236073	13375	" " " " Oil Guard

No.	Plate	Name
209161b	10247	Needle Bar Connecting Link Oil Guard Screw
202333	10248	Needle Bar Connecting Link Stud with 202254
202254	---	Needle Bar Connecting Link Stud Oil Packing (wick)
200374c	13375	Needle Bar Connecting Link Stud Set Screw
*206891	---	Needle Bar Connecting Stud
202329	10248	" " " " 206891 with 200086c and 202330
202330	---	Needle Bar Connecting Stud Oil Packing (wick)
200086c	10248	Needle Bar Connecting Stud Pinch Screw
202328	13376	Needle Bar Crank with 200335c, 200428c, 202333 and two 200374c
203117	---	Needle Bar Crank 202328 with 202329, 202331 and 202398 to 202400
203172	10248	Needle Bar Crank Friction Washer
200428c	10248	" " " Position Screw
200335c	10244	" " " Set Screw
200141F	10248	" Set Screw
244033	---	Presser Bar (hollow)
202335	10667	" " 244033 with 200074F
207072	13375	" " Bushing
200352c	10248	" " " Set Screw
202339	13375	" " Lifter
200653c	13375	" " " Hinge Screw
244004	13375	" " Lifting Releasing Lever Bracket
200260b	13375	Presser Bar Lifting Releasing Lever Bracket Guide Screw
206608	13375	Presser Bar Lifting Releasing Lever Bracket Spring
202337	13375	Presser Bar Position Guide
202338	13375	" " " " Lever with 200086F
200086F	10248	Presser Bar Position Guide Lever Pinch Screw
200352c	10248	Presser Bar Position Guide Set Screw
202343	13378	Presser Bar Spring (high)
202346	13378	" " " Stop Rod
200492B	13378	" " Thumb Screw (pressure regulating)
200475B	13378	Presser Bar Thumb Screw Thumb Set Screw

No.	Plate	Name
202355	13378	Presser Bar Thumb Screw Thumb Set Screw Packing (brass)
203177	13380	Presser Foot
200074F	13378	" " Screw
202068	12153	Spool Holder Base
200575H	13378	" " " Screw
204296	12153	" " Wire
200079H	13378	" " " Hinge Screw
204297	12153	Spool Holder complete, Nos. 200079H, 202068 and 204296
202397	13378	Take-up (auxiliary)
200842E	13378	" " Screw
202398	10247	" Lever
202399	10247	" " Driving Stud with 202277
202277	---	Take-up Lever Driving Stud Oil Packing (wick)
202400	10247	Take-up Lever Hinge Stud with 202423
202423	---	Take-up Lever Hinge Stud Oil Packing (wick)
200383c	10246	Take-up Lever Hinge Stud Set Screw
202401	10247	Take-up Lever Oiling Felt
200432E	10247	" " " " Screw
244007	10247	Tension Disc (back)
244008	10247	" " (front)
202404	10247	" Release Plunger
202405	10247	" " Washer
202407	10881	" Spring
200625F	10247	" Stud with 204925
200061c	13378	" " Set Screw
204925	13378	" " Washer
201572b	10881	" Thumb Nut
202409	10252	Tension complete, Nos. 200625F, 201572b, 202405, 202407, 202410, 244007 and 244008
202410	10252	Thread Controller Spring
202411	10252	" " " Stop
200432E	10247	" " " " Screw
202413	10252	" Guide
202414	10252	" "
202415	10252	" "
202417	10252	" "
200582H	10252	" " Screw
200355H	10252	" Set Screw
200368H	13378	" " " "
202091	10252	" Retainer Sleeve
202092	10252	" " Spring

No.	Plate	Name
204058	10252	Thread Retainer Stud
200368H	13378	" " " Set Screw ..
204059	---	Thread Retainer complete, Nos. 202091, 202092 and 204058
202830	13380	Throat Plate, 53 needle hole, for needle sizes 12 and 13, with 202534, 202619 and two 200583H ..
202534	10390	Throat Plate Bobbin Case Stop ..
202619	13375	" " " " " Po- sition Pin
200583H	13378	Throat Plate Bobbin Case Stop Screw
200577H	10245	Throat Plate Screw (2)
225935	10381	Tuck Marker
244027	13379	" " Guide
244028	---	" " " 244027 with 200179H and 244029
200469B	13378	Tuck Marker Guide Thumb Screw
244029	13379	" " " Tuck Smooth- ing Spring
200179H	10361	Tuck Marker Guide Tuck Smooth- ing Spring Screw
200125F	10381	Tuck Marker Set Screw
225936	13379	" " Shaft with 200125F ...
225937	13379	" " " Bracket with two 200579E
244030	13379	Tuck Marker Shaft Bracket Base Plate
200567H	---	Tuck Marker Shaft Bracket Base Plate Screw (2)
200579E	10359	Tuck Marker Shaft Bracket Screw
225945	---	" " " Driving Crank with 201813
225896	----	Tuck Marker Shaft Driving Crank Cap
200047C	10381	Tuck Marker Shaft Driving Crank Pinch Screw
201829	10381	Tuck Marker Shaft Driving Crank Roller
201813	13378	Tuck Marker Shaft Driving Crank Roller 201829 with 200274E
200274E	10381	Tuck Marker Shaft Driving Crank Roller Screw Stud
225939	13379	Tuck Marker Shaft Driving Crank complete, Nos. 200047C, 225896 and 225945
225941	13379	Tuck Marker Shaft Rock Lever
225997	---	" " " " " " 225941 with 225942

No.	Plate	Name
200852B	10381	Tuck Marker Shaft Rock Lever Pinch Screw
225942	10381	Tuck Marker Shaft Rock Lever Pinch Screw Handle with 200852B
225943	10381	Tuck Marker Shaft Stop Collar with 200481B
200481B	10381	Tuck Marker Shaft Stop Collar Thumb Screw
225931	10381	Tuck Marker Tuck Creaser
*225932	---	" " " " " Plate
225707	13379	" " " " " " 225932 with 202115, 225931, 225933, 225934, two each 200142E and 200172H
202115	13379	Tuck Marker Tuck Creaser Plate Spring
200142E	10346	Tuck Marker Tuck Creaser Plate Spring Screw
225933	10381	Tuck Marker Tuck Creaser Slide
225934	10381	" " " " " " Spring
200172H	10381	Tuck Marker Tuck Creaser Slide Spring Screw
244031	---	Tuck Marker with 200469B, 225707, 225935 to 225937, 225939, 225997, 244028, 244030 and two 225943 ...
244032	----	Tuck Marker complete, Nos. 202294, 202830, 203177, 203187, 206992 and 244031

LIST OF PARTS COMPLETE
FOR
MACHINE No. 61w84

HAS MECHANICAL OPENER

For Shirts, Corsets, Underwear, Shirt Waists,
 Flannels, Etc

No.	Plate	Name
*207079	----	Arm
202247	10667	" Cap
200278H	10244	" " Screw
202248	10244	" " " Washer
204235	13375	" Position Pin (2)
200010E	10245	" Screw (3)
202005	10245	" " Washer (3)
202249	13351	" Shaft with 200357E and 203100
202243	13351	" " Bushing (back) with 202244
207080	13376	Arm Shaft Bushing (front) with 202244
200502B	10246	Arm Shaft Bushing (front) Oil Packing Thumb Screw
202244	----	Arm Shaft Bushing Oil Packing (wick)
200335c	10244	Arm Shaft Bushing Set Screw (2)
202530	13351	" " Connection Belt
202252	10244	" " " " Pulley with 200327c, 200602e and two 202253
200602E	10244	Arm Shaft Connection Belt Pulley Position Screw
200327c	10244	Arm Shaft Connection Belt Pulley Set Screw
202253	10244	Arm Shaft Connection Belt Pulley Spring Flange
203100	----	Arm Shaft Oil Packing (wick)
200357E	10244	" " " " Stop Screw
202255	13351	Balance Wheel (belt groove 2½ in. diam.) with 200328c and 200335c
200328c	10244	Balance Wheel Position Screw
200335c	10244	" " " " Set Screw

No.	Plate	Name
*207081		Bed
207082	13376	" Plate (back)
200577H	10245	" " " Screw (2)
207083	13376	" Slide (front)
202265	11671	Bobbin
207057	13363	" Case Base
206733	13378	" " Cap with 200592c, 201016F and 206738
206734	13363	Bobbin Case Cap complete, Nos. 200964E, 206733, 206736 and 210736
206735	13363	Bobbin Case Latch
206736		" " " 206735 with 206731 and 206737
206731	13363	Bobbin Case Latch Fulcrum Pin
206737	13363	" " " Lever
210736	13363	" " " Spring
200964E	13363	" " " Stop Screw
206738	13363	" " " Tension Spring
201016F	13363	" " " " Regulat- ing Screw
200592c	13378	Bobbin Case Tension Spring Screw
207058	13363	Bobbin Case complete, Nos. 206734 and 207057
202500	13378	Bobbin Case Lever
202501	13378	" " " Bushing
200333c	13378	" " " " Set Screw
244018	13378	" " " Driving Eccen- tric with 200380c and 200444c
244019		Bobbin Case Lever Driving Eccen- tric 244018 with 200583H and 206761
206728	13363	Bobbin Case Lever Driving Eccen- tric Connection with 244009
244020		Bobbin Case Lever Driving Eccen- tric Connection 206728 with 201194c, 201524c, 206758 and 244019
206730	13363	Bobbin Case Lever Driving Eccen- tric Connection Lever with 200086c
201194c	13363	Bobbin Case Lever Driving Eccen- tric Connection Lever Hinge Screw Stud
201524c	13378	Bobbin Case Lever Driving Eccen- tric Connection Lever Hinge Screw Stud Nut
206758	---	Bobbin Case Lever Driving Eccen- tric Connection Lever Oil Wick..

No.	Plate	Name
200086c	10248	Bobbin Case Lever Driving Eccentric Connection Lever Pinch Screw
244009	—	Bobbin Case Lever Driving Eccentric Connection Oil Packing (wick)
200380c	13378	Bobbin Case Lever Driving Eccentric Set Screw
200444c	13375	Bobbin Case Lever Driving Eccentric Spot Screw
206761	13363	Bobbin Case Lever Driving Eccentric Washer
200583H	13378	Bobbin Case Lever Driving Eccentric Washer Screw
244021	—	Bobbin Case Outfit complete, Nos. 200333c, 202500, 202501, 206730, 207058 and 244020
200459D	13375	Cloth Guide Thumb Screw
202274	10667	Face Plate
202135	10245	" " Position Pin
200462B	10245	" " Thumb Screw
202275	10667	Feed Bar
200641c	10246	" " Hinge Screw (driving) ..
201522E	10240	" " " " Nut
202276	10245	" " Slide Block
202298	10245	" " " " Crank with 200038c
203124	—	Feed Bar Slide Block Crank 202298 with 200205E, 201518E and 202276
200038c	10245	Feed Bar Slide Block Crank Pinch Screw
200205E	10245	Feed Bar Slide Block Hinge Screw
201518E	10245	" " " " " " " " Nut
202282	10913	Feed Dog
200106E	10245	" " Screw (2)
202297	10667	" Driving Connection with 200054E and 202277
202298	10245	Feed Driving Connection Crank with 200038c
200038c	10245	Feed Driving Connection Crank Pinch Screw
200545c	10245	Feed Driving Connection Hinge Screw
201518E	10245	Feed Driving Connection Hinge Screw Nut
202277	—	Feed Driving Connection Oil Packing (wick)
200054E	10246	Feed Driving Connection Pinch Screw

No.	Plate	Name
202300	10246	Feed Driving Eccentric Regulating Bracket
203134	—	Feed Driving Eccentric Regulating Bracket 202300 with 202252, two each 201014c and 201525E
201014c	10245	Feed Driving Eccentric Regulating Bracket Hinge Screw
201525E	10245	Feed Driving Eccentric Regulating Bracket Hinge Screw Nut
202301	10246	Feed Driving Eccentric Regulating Bracket Plunger
202595	10246	Feed Driving Eccentric Regulating Bracket Plunger Spring
200607c	10246	Feed Driving Eccentric Regulating Bracket Plunger Spring Stop Screw
201014c	10245	Feed Driving Eccentric Regulating Bracket Stop Screw
201525E	10245	Feed Driving Eccentric Regulating Bracket Stop Screw Nut
200429c	10246	Feed Driving Eccentric Regulating Screw
200383c	10246	Feed Driving Eccentric Regulating Screw Check Screw
202303	13377	Feed Driving Rock Shaft
206860	—	" " " " " " 202303 with 200641c, 201522E and 202275
203121	—	Feed Driving Rock Shaft 206860 with 202282 and two 200106c
202305	10245	Feed Driving Rock Shaft Center (2)
200043c	10246	" " " " " " Set Screw (2)
202306	10667	Feed Lifting Connection with 200054E and 202277
202307	10246	Feed Lifting Connection Eccentric with 200382c and 200437c
200437c	10246	Feed Lifting Connection Eccentric Position Screw
200382c	10359	Feed Lifting Connection Eccentric Set Screw
200545c	10245	Feed Lifting Connection Hinge Screw
201518E	10245	Feed Lifting Connection Hinge Screw Nut
202277	—	Feed Lifting Connection Oil Packing (wick)
200054E	10246	Feed Lifting Connection Pinch Screw

No.	Plate	Name
202308	13377	Feed Lifting Rock Shaft
202305	10245	" " " " Center (2)
200043c	10246	" " " " Set Screw (2)
202310	13376	Feed Regulating Spindle with 202311, 202443 and 202619
*202311	----	Feed Regulating Spindle Head ...
202443	10244	" " " " Pin
202619	13375	" " " " Position Pin
*244010	----	Hook (sewing)
244011	13377	" 244010 with 200145c, 200596c, 200614c, 202320, 203101, 206775, 206852 and 244014
244022	----	Hook and Bobbin Case complete, Nos. 207058 and 244011
206852	13375	Hook Gib
200614c	11671	" " Hinge Screw
200596c	11671	" " Screw
203101	----	" Oil Wick
*202320	----	" Shaft, 11 $\frac{1}{2}$ in. long
202321	10245	" " Bushing (back)
200346c	10245	" " " " Set Screw
202322	10245	" " " (front)
200346c	10245	" " " " Set Screw
202323	10244	" " Connection Belt Pulley with 202324 and two 201018c ...
201018c	13375	Hook Shaft Connection Belt Pulley Set Screw
202324	10244	Hook Shaft Connection Belt Pulley Spring Flange
202260	----	Hook Shaft Oil Packing (wick) (2)
206775	11671	" " Pin
244014	13375	" Washer
200145c	11671	" " Screw
237837	13377	Knee Lifter Connection Lever
244035	----	" " " " 237837 with 202447, 244034 and two 200262n
200262n	10248	Knee Lifter Connection Lever Hinge Screw
202447	13376	Knee Lifter Connection Lever Lifting Rod with 202302
202302	10248	Knee Lifter Connection Lever Lifting Rod Cotter Pin
244034	13377	Knee Lifter Lifting Lever
200262n	10248	" " " " Hinge Screw

No.	Plate	Name
202326	10248	Needle Bar with 200141c
202327	10248	" " Bushing
203123	----	" " " " 202327 with 202326
200352c	10248	Needle Bar Bushing Set Screw ...
202331	10248	" " Connecting Link
236073	13375	" " " " Oil Guard
200161b	10247	Needle Bar Connecting Link Oil Guard Screw
202333	10248	Needle Bar Connecting Link Stud with 202254
202254	----	Needle Bar Connecting Link Stud Oil Packing (wick)
200374c	13375	Needle Bar Connecting Link Stud Set Screw
*206891	----	Needle Bar Connecting Stud
202329	10248	" " " " 206891 with 200086c and 202330
202330	----	Needle Bar Connecting Stud Oil Packing (wick)
200086c	10248	Needle Bar Connecting Stud Pinch Screw
202328	13376	Needle Bar Crank with 200335c, 200428c, 202333 and two 200374c
203117	----	Needle Bar Crank 202328 with 202329, 202331 and 202398 to 202400
203172	10248	Needle Bar Crank Friction Washer
200428c	10248	" " " Position Screw ..
200335c	10244	" " " Set Screw
200141c	10248	" Set Screw
244033	----	Presser Bar (hollow)
202335	10667	" " 244033 with 200074c ..
207072	13375	" " Bushing
200352c	10248	" " " Set Screw
202339	13375	" " Lifter
200653c	13375	" " " Hinge Screw
244004	13375	" " Lifting Releasing Lever Bracket
200260b	13375	Presser Bar Lifting Releasing Lever Bracket Guide Screw
206608	13375	Presser Bar Lifting Releasing Lever Bracket Spring
202337	13375	Presser Bar Position Guide
202338	13375	" " " " Lever with 200086c
200086c	10248	Presser Bar Position Guide Lever Pinch Screw

No.	Plate	Name
200352C	10248	Presser Bar Position Guide Set Screw
202343	13378	Presser Bar Spring (light)
202346	13378	" " " Stop Rod
200492B	13378	" " Thumb Screw (pres- sure regulating)
200475B	13378	Presser Bar Thumb Screw Thumb Set Screw
202355	13378	Presser Bar Thumb Screw Thumb Set Screw Packing (brass)
202418	10929	Presser Foot
200074F	13378	" " Screw
202068	12153	Spool Holder Base
200575H	13378	" " " Screw
204296	12153	" " Wire
200079H	13378	" " " Hinge Screw
204297	12153	Spool Holder complete, Nos. 200079H, 202068 and 204296
202397	13378	Take-up (auxiliary)
200842E	13378	" " Screw
202398	10247	" Lever
202399	10247	" " Driving Stud with 202277
202277	---	Take-up Lever Driving Stud Oil Packing (wick)
202400	10247	Take-up Lever Hinge Stud with 202423
202423	---	Take-up Lever Hinge Stud Oil Packing (wick)
200383C	10246	Take-up Lever Hinge Stud Set Screw
202401	10247	Take-up Lever Oiling Felt
200132E	10247	" " " " Screw ..
244007	10247	Tension Disc (back)
244008	10247	" " (front)
202404	10247	" Release Plunger
202405	10247	" " Washer
202407	10881	" Spring
200625F	10247	" Stud with 204925
200061C	13378	" " Set Screw
204925	13378	" " Washer
201572B	10881	" Thumb Nut
202409	10252	Tension complete, Nos. 200625F, 201572B, 202405, 202407, 202410, 244007 and 244008
202410	10252	Thread Controller Spring
202411	10252	" " " Stop
200132E	10247	" " " " Screw

No.	Plate	Name
202413	10252	Thread Guide
202414	10252	" " "
202415	10252	" " "
202417	10252	" " "
200582H	10252	" " Screw
200355H	10252	" " Set Screw
200368H	13378	" " " "
202091	10252	" Retainer Sleeve
202092	10252	" " Spring
204058	10252	" " Stud
200368H	13378	" " " Set Screw
204059	-	Thread Retainer complete, Nos. 202091, 202092 and 204058
202818	13354	Throat Plate, 50 needle hole, for needle sizes 14 and 15, with 202534, 202619 and two 200583H ..
202534	10390	Throat Plate Bobbin Case Stop ...
202619	13375	" " " " " Po- sition Pin
200583H	13378	Throat Plate Bobbin Case Stop Screw
200577H	10245	Throat Plate Screw (2)

MACHINE No. 61w154

For Shirts, Corsets, Underwear, Shirt Waists,
Flannels, Etc

Same as Machine No. 61w84 with the following
exceptions:

No.	Plate	Name
*207084	---	Arm, in place of 207079
202250	13365	" Shaft with 200357e and 203100, in place of 202249
*207085	---	Bed, in place of 207081
207086	13376	" Slide (front), in place of 207083
202304	13365	Feed Driving Rock Shaft, in place of 202303
203122	---	Feed Driving Rock Shaft 202304 with 200641c, 201522e and 202275, in place of 206860
202654	13365	Feed Lifting Rock Shaft, in place of 202308
244023	13377	Hook 244010 with 200145c, 200596e, 200614c, 202319, 203101, 206775, 206852 and 244014, in place of 244011
244024	---	Hook and Bobbin Case complete, Nos. 207058 and 244023, in place of 244022
*202319	---	Hook Shaft, 13 $\frac{3}{4}$ in. long, in place of 203320
244037	---	Knee Lifter Connection Lever 237837 with 202447, 244036 and two 200262n, in place of 244035
244036	13377	Knee Lifter Lifting Lever, in place of 244034

ACCESSORIES

FOR MACHINES NOS. 61w52 and 61w84

No.	Plate	Name
200157b	13380	Attachment Screw
202265	11671	Bobbin (5)
*225482	---	" Case Screw Driver Blade ...
*225483	---	" " " " Handle ..
225497	12153	Bobbin Case Screw Driver com- plete, Nos. 225482 and 225483 ...
231337	13380	Cloth Guide
12361	13380	Machine Hinge Connection (2) ...
135 x 1	---	Needles, three each, sizes 12 and 14
228212	---	Drip Pan (short) with four 1 in. wire nails
41400	12153	Machine Rest Pin
120342	12153	Oiler with 120343
120343	12153	" Spout, 3 $\frac{1}{2}$ in. long
*225484	---	Screw Driver Blade
*225485	---	" " Handle
225498	12153	Screw Driver complete (7 $\frac{1}{2}$ in. long), Nos. 225484 and 225485 ...
225554	12153	Wrench (steel)

BOBBIN WINDER

Swing Automatic, Right Hand

225453	10884	Frame with 202277 and 225438 ...
225454	10884	" Hinge Pin
202277	---	" Oil Packing (wick)
225438	10884	" " Well Cap
225455	10884	" Spring
225456	10884	" " Flunger
202473	10885	Pulley with 200380c
200380c	13378	" Set Screw
225381	10884	Spindle
225444	10884	Stop Latch
200056e	10884	" " Screw
225458	10884	" " Thumb Lever
225459	10884	" " " " Hinge Stud
225459	10884	" " " " Joint Stud
202478	10884	" " Trip Lever
200299n	10884	" " " " Hinge Screw

No.	Plate	Name
225461	10881	Tension Bracket with 201499B
200082D	10881	" " Screw
228026	10884	" " Washer
2102	10881	" Disc
202407	10881	" Spring
201499B	10881	" Stud
201572B	10881	" " Thumb Nut
225462	10881	Bobbin Winder Tension Bracket complete, Nos. 201572B, 202407, 225461 and two 2102
225433	10885	Bobbin Winder and Tension Bracket Base
225382	10885	Universal Bobbin Winder complete, Nos. 200056E, 200082D, 200299B, 202473, 202478, 225381, 225433, 225444, 225453 to 225456, 225458, 225462, 228026, two each 225459 and wood screws $\frac{3}{4}$ in., No. 12, R.H.B.

KNEE LIFTER PARTS

2763	14171	Rock Shaft
7539	14171	" " Hanger (back) with two wood screws 1 in., No. 10
20093	14171	Rock Shaft Hanger (front) with two wood screws 1 in., No. 10
2765	14171	Rock Shaft Knee Arm
2768	—	" " " " 2765 with 2766 and 2767
2766	14171	Rock Shaft Knee Arm Hub with 356c
356c	14171	Rock Shaft Knee Arm Hub Set Screw
2767	14171	Rock Shaft Knee Plate with 356c
356c	14171	" " " " Set Screw
228238	14171	" " Lifting Lever with 356c
228239	—	" " " " 228238 with 8073, 204225, 228240 and 228241
228240	14171	Rock Shaft Lifting Lever Rod (3 in. long)
200529c	14171	Rock Shaft Lifting Lever Rod Set Screw
228241	14171	Rock Shaft Lifting Lever Rod Swivel with 200529c
204225	14171	Rock Shaft Lifting Lever Rod Swivel Spring

No.	Plate	Name
8073	14171	Rock Shaft Lifting Lever Rod Swivel Spring Plunger
356c	14171	Rock Shaft Lifting Lever Set Screw
2770	14171	" " Stop Dog with 356c
356c	14171	" " " " Set Screw
228242	14171	Knee Lifter Rock Shaft complete, Nos. 2763, 2768, 7539, 20093, 228239 and two 2770
(Other Knee Lifter Parts are listed with parts of machine head)		

FOR MACHINE No. 61w72

Same as for No. 61w52 with the following exceptions:

203187	13380	Presser Foot
206992	13380	" "

FOR MACHINE No. 61w154

Same as for No. 61w52 with the following exceptions:

228213	—	Drip Pan (long) with four 1 in. wire nails, in place of 228212
--------	---	--

KNEE LIFTER PARTS

2763	14171	Rock Shaft
7539	14171	" " Hanger (back) with two wood screws 1 in., No. 10
20093	14171	Rock Shaft Hanger (front) with two wood screws 1 in., No. 10
228562	14407	Rock Shaft Knee Arm
228563	—	Rock Shaft Knee Arm complete, Nos. 1507B, 2766, 2767 and 228562
2766	14171	Rock Shaft Knee Arm Hub with 356c
356c	14171	Rock Shaft Knee Arm Hub Set Screw
1507B	13380	Rock Shaft Knee Arm Lock Nut
2767	14171	" " " Plate with 356c
228255	14407	" " " " Counter Balance Spring
356c	14171	Rock Shaft Knee Plate Set Screw
228238	14171	" " Lifting Lever with 356c
228239	—	" " " " 228238 with 8073, 204225, 228240 and 228241

No.	Plate	Name
228240	14171	Rock Shaft Lifting Lever Rod (3 in. long)
200529c	14171	Rock Shaft Lifting Lever Rod Set Screw
228241	14171	Rock Shaft Lifting Lever Rod Swivel with 200529c
204225	14171	Rock Shaft Lifting Lever Rod Swivel Spring
8073	14171	Rock Shaft Lifting Lever Rod Swivel Spring Plunger
356c	14171	Rock Shaft Lifting Lever Set Screw
2770	14171	" " Stop Dog with 356c ...
356c	14171	" " " " Set Screw ...
228243	14407	Knee Lifter Rock Shaft complete, Nos. 2763, 7539, 20093, 228239, 228255, 228563, Form A 1079 and two 2770

(Other Knee Lifter Parts are listed with parts of machine head)

FEED DOGS

No.	Plate	Name
202278	10913	Feed Dog, for binding, for 202811 and 225996
202281	10913	Feed Dog, for 202815
202282	10913	" " " general muslin work, for 202818, 202951, 203073, 203113 and 203121
202283	10913	Feed Dog, for handkerchief hemming knit goods and shoe lining
202284	10913	Feed Dog, for binding dress shields, for 202812
202287	10913	Feed Dog, for muslin work and gathering, for 202822
202289	10913	Feed Dog, for 202817
202290	10912	" " " special work, for 202824
202293	10912	Feed Dog, 21 teeth (22 teeth to the inch), for tucking, for 202827 and 244041
202294	10912	Feed Dog, for tucking, for 202828, 202830 and 244032
202295	10912	Feed Dog, for tucking, for 202829..
202296	10912	" " " " " 202831..
202970	10912	" " " general muslin work, for 202969
203071	10912	Feed Dog, for 203056 and 206975 ..
203072	10912	" " " 203053
203083	10912	" " " 203063
203136	13354	" " " 202816
203173	13354	" " " 226000
203417	13354	" " " 203111
207051	10915	" " " handkerchief hemming, knit goods and shoe lining, for 202819
207052	10915	Feed Dog, for handkerchief hemming, knit goods and shoe lining, for 202819
207053	10915	Feed Dog, for shirt, collar and cuff work, for 202817
207054	10915	Feed Dog, for shirt, collar and cuff work, for 202817
207055	10915	Feed Dog, for general muslin work, for 202818, 202951, 203073 and 203113

No.	Plate	Name
207056	10915	Feed Dog, for general muslin work, for 202818, 202951, 203073 and 203113
207075	13380	Feed Dog, for leather work, for 207076
225977	10310	Feed Dog, for 225622
230625	13354	" " " 230749, 230751 and 230833

PRESSER FEET

26608	13355	Presser Foot (glass)
202354	10926	" " for $\frac{1}{32}$, $\frac{1}{16}$ and $\frac{1}{8}$ in. stitching margins, for collar and cuff work
202356	10263	Presser Foot, for binding
202361	10926	" " " "
202368	10259	" " (deep grooved) (grooved to left of needle hole), from 4 to 16 cords to the in., as ordered, for top cording
202369	10259	Presser Foot (deep grooved) (grooved to left of needle hole), from 4 to 16 cords to the in., as ordered, for top cording
202370	10259	Presser Foot (deep grooved) (grooved to right of needle hole), from 4 to 16 cords to the in., as ordered, for top cording
202373	13355	Presser Foot, for gathering
202375	10926	" " " mattress binding
202376	10926	" " " " " "
202390	10263	" " " front steel stitching in corset work
202418	10929	Presser Foot
202529	10926	" " (split), for gathering
203177	13380	" "
203179	10926	" " for $\frac{1}{16}$ in. stitching margin, for collar and cuff work
203187	13380	Presser Foot, for tuck marking or creasing

No.	Plate	Name
203198	13355	Presser Foot, for laying tucks
203199	13355	" " " narrow tucks
206528	10925	" " " stitching margins $\frac{1}{32}$, $\frac{1}{16}$ and $\frac{1}{8}$ inch
206785	10929	Presser Foot
206786	10929	" " (split)
206787	13355	" " for stitching margins from $\frac{1}{32}$ to $\frac{1}{4}$ in., in steps of $\frac{1}{32}$ inch
206788	10929	Presser Foot
206791	10925	" " for use with English Binder
206792	10925	Presser Foot, for stitching margins from $\frac{1}{16}$ to $\frac{1}{4}$ in., in steps of $\frac{1}{16}$ inch
206794	10929	Presser Foot, for tailoring work
206841	13355	" " " binding
206992	13380	" " " tuck marking or creasing
225508	10923	Presser Foot, for gathering
225621	10310	" "
225690	10923	" " from 4 to 16 cords to the in., as ordered, for top and bottom cording
225702	13356	Presser Foot, for Welts
225723	10926	" "
225792	10350	" "
225798	10353	" "
225862	13356	" " for stitching margins from $\frac{1}{16}$ to $\frac{1}{4}$ in., in steps of $\frac{1}{16}$ in., for collar and cuff work
225949	13356	Presser Foot, for Welts
226029	10923	" " " darning
229597	10925	" " stitching margins from $\frac{1}{4}$ to $\frac{1}{8}$ in., in steps of $\frac{1}{8}$ in., for open bosom shirts
229856	10929	Presser Foot
229857	10929	" "
229858	10929	" "
229880	13356	" " for binding suspenders
230745	14650	" " " cord covering
206842	13356	" " Cleft Holder
206998	13356	Presser Foot Holder with 2005430, for Presser Bar 202335 as a substitute for Compound Presser Bar 202514

No.	Plate	Name
200543u	13356	Presser Foot Screw
202366	10926	" " for stitching margins from $\frac{1}{8}$ to $\frac{1}{4}$ in., in steps of $\frac{1}{16}$ in., with 200175u and 202810
206790	10927	Presser Foot, for stitching margins from $\frac{1}{8}$ to $\frac{1}{4}$ in., in steps of $\frac{1}{16}$ in., with 200904e and 202809
229871	10925	Presser Foot (right hand spring guide), stitching margins from $\frac{1}{8}$ to $\frac{1}{4}$ in., in steps of $\frac{1}{16}$ in., with 200175u and 202807. Order margin required
202809	10927	Presser Foot Adjustable Spring Guide
200904e	13356	Presser Foot Adjustable Spring Guide Screw
202807	10925	Presser Foot Spring Guide
202810	10926	" " " "
200175u	10360	" " " " Screw
203037	-----	" " Plate with 231235 to 231237 and six 200175u
202572	13356	Presser Foot Hinge Pin
231235	-----	" " Strip Guide with 200488c
231236	-----	Presser Foot Strip Guide Bar
231237	-----	" " " " " " Plate
200175u	10360	" " " " " " Screw
200488c	13380	Presser Foot Strip Guide Thumb Screw
231238	13355	Presser Foot (hinged) (adjustable) complete, for strips $\frac{1}{8}$ to $\frac{1}{4}$ in., Nos. 202572, 202924 and 203037, for stitching shoe facings
202090	13356	Presser Foot Hinge Pin
203009	-----	" " Plate, for 229864
203010	-----	" " " " 229863
203011	-----	" " " " 229867
203012	-----	" " " " 229868
203024	-----	" " " " 229865
203034	-----	" " " " 202372
203035	-----	" " " " 202371
203322	-----	" " " " 203323
229055	-----	" " " " 202351
202924	-----	" " Shank
202351	10927	Presser Foot (hinged) complete, 46 needle hole, Nos. 202090, 202924 and 229055, for knif goods

No.	Plate	Name
202371	13356	Presser Foot (hinged) complete, Nos. 202090, 202924 and 203035, for umbrella hemming
202372	13352	Presser Foot (hinged) complete, Nos. 202090, 202924 and 203034, for handkerchief hemming
202323	13356	Presser Foot (hinged) complete, 50 needle hole, Nos. 202090, 202924 and 203322
229863	10927	Presser Foot (hinged) complete, Nos. 202090, 202924 and 203010, for overalls and tailoring
229864	10927	Presser Foot (hinged) complete, Nos. 202090, 202924 and 203009
229865	10927	Presser Foot (hinged) complete, Nos. 202090, 202924 and 203024, for tailoring
229867	10927	Presser Foot (hinged) complete, Nos. 202090, 202924 and 203011, for overalls
229868	10927	Presser Foot (hinged) complete, Nos. 202090, 202924 and 203012

THROAT PLATES

No.	Plate	Name
202811	13354	Throat Plate, 50 needle hole, for needle sizes 14 and 15, with 202534, 244026 and two 200582u, for binding corsets and similar work, for 202278
202812	10390	Throat Plate, 46 needle hole, for needle sizes 16 and 18, with 202534, 202619 and two 200583u, for 202284, 226197, 226215 and 226239
202815	10391	Throat Plate, 53 needle hole, for needle sizes 12 and 13, with 202534, 202619 and two 200583u, for tucking work, for 202281
202816	10391	Throat Plate, 50 needle hole, for needle sizes 14 and 15, with 202534, 202619 and two 200582u, for top cording, for 203136
202817	10391	Throat Plate, 60 needle hole, for needle sizes 8 and 9, with 202534, 202619 and two 200583u, for fine shirt work, for 202289, 207053 and 207054
202818	13354	Throat Plate, 50 needle hole, for needle sizes 14 and 15, with 202534, 202619 and two 200583u, for 202282, 207055 and 207056 ..
202819	10391	Throat Plate, 50 needle hole, for needle sizes 14 and 15, with 202534, 202619 and two 200583u, for 202283, 207051 and 207052 ..
202822	10391	Throat Plate, 50 needle hole, for needle sizes 14 and 15, with 202534, 202619 and two 200583u, for muslin work and gathering, for 202287
202824	10390	Throat Plate, 50 needle hole, for needle sizes 14 and 15, with 202534, 202619 and two 200583u, for special work, for 202290
202827	10390	Throat Plate, 53 needle hole, for needle sizes 12 and 13, with 202534, 202619 and two 200583u, for 202293 and 244041

No.	Plate	Name
202828	13354	Throat Plate, 53 needle hole, for needle sizes 12 and 13, with 202534, 202619 and two 200583u, for tucking with Tuck Folder, for 202294
202829	10390	Throat Plate, 53 needle hole, for needle sizes 12 and 13, with 202534, 202619 and two 200583u, for special tucking, for 202295 ..
202830	13380	Throat Plate, 53 needle hole, for needle sizes 12 and 13, with 202534, 202619 and 200583u, for 202294 and 244032
202831	10391	Throat Plate, 50 needle hole, for needle sizes 14 and 15, with 202534, 202619 and two 200583u, for 202296
202951	13357	Throat Plate, 56 needle hole, for needle sizes 10 and 11, with 202534, 202619 and two 200583u, for 202282, 207055 and 207056 ..
202969	10917	Throat Plate, 50 needle hole, for needle sizes 14 and 15, with 202534, 202619 and two 200583u, for fine shirt work, for 202970 ..
203053	10917	Throat Plate, 53 needle hole, for needle sizes 12 and 13, with 202534, 202619 and two 200583u, for 203072
203056	10917	Throat Plate, 50 needle hole, for needle sizes 14 and 15, with 202534, 202619 and two 200583u, for tucking, for 203071
203063	10917	Throat Plate, 50 needle hole, for needle sizes 14 and 15, with 202534, 202619 and two 200582u, for special work, for 203083
203073	10917	Throat Plate, 46 needle hole, for needle sizes 16 and 18, with 202534, 202619 and two 200583u, for 202282, 207055 and 207056 ..
203111	13357	Throat Plate, 50 needle hole, for needle sizes 14 and 15, with 202534, 202619 and two 200583u, for regular cloth work, for 203417
203113	13357	Throat Plate, 40 needle hole, for needle sizes 20 and 22, with 202534, 202619 and two 200583u, for general muslin work, for 202282, 207055 and 207056

No.	Plate	Name
206975	13357	Throat Plate, 50 needle hole, for needle sizes 14 and 15, with 202534, 202619 and two 200583u, for 203071
207076	13380	Throat Plate, 50 needle hole, for needle sizes 14 and 15, with 202534, 202619 and two 200583u, for 207975
225622	10310	Throat Plate, 53 needle hole, for needle sizes 12 and 13, with 202534, 202619 and two 200582u, for 225977
226000	13357	Throat Plate, 53 needle hole, for needle sizes 12 and 13, with 202534, 202619 and two 200583u, for top and bottom cording, for 203173
230749	14650	Throat Plate, 50 needle hole, for needle sizes 14 and 15, with 201566u, 202534 and two 200583u, for 230625 and 230751
230833	13357	Throat Plate, 50 needle hole, for needle sizes 14 and 15, with 201566u, 202534 and two 200583u. Used with Cord Covering Attachment, for 230625
201566u	13357	Cord and Strip Folder Thumb Nut, for 230749 and 230833
200582u	10252	Throat Plate Bobbin Case Stop Screw
244026	13380	Throat Plate Bobbin Case Stop Position Pin

BINDERS

No.	Plate	Name
225646	10316	Binder on Shank, for tapes from $\frac{1}{2}$ to 1 in. in steps of $\frac{1}{16}$ inch
		Note: State width required, send samples of material to be bound and sufficient tape to test Binder.
225659	10316	Bias Binder on Shank, for binding from $\frac{1}{2}$ to 1 in., in steps of $\frac{1}{16}$ inch
		Note: State width required, send samples of material to be bound and sufficient binding to test Binder.

BINDER

For Tapes or Folded Strips Without Seams

225624	11598	Binder on Shank, for tapes $\frac{3}{8}$, $\frac{1}{2}$, $\frac{5}{8}$, $\frac{3}{4}$, $\frac{7}{8}$, $\frac{15}{16}$, $\frac{1}{2}$, $\frac{3}{4}$ and 1 inch
		Note: State width required, send samples of material to be bound and sufficient tape to test Binder.

BOSTON BINDER

For Shoes and Slippers

225630	10312	Binder on Shank, for tapes from $\frac{1}{2}$ to 1 in. in steps of $\frac{1}{16}$ inch
		Note: State width required, send samples of material to be bound and sufficient tape to test Binder.
225631	10312	Binder on Shank with Shank extending beyond Binder, for tapes of the following widths: $\frac{3}{8}$, $\frac{1}{2}$, $\frac{5}{8}$, $\frac{3}{4}$, $\frac{7}{8}$, $\frac{15}{16}$, $\frac{1}{2}$, $\frac{3}{4}$ and 1 inch
202283	10913	Feed Dog
202356	10263	Presser Foot
202819	10391	Throat Plate, 50 needle hole, for needle sizes 14 and 15, with 202534, 202619 and two 200583u..

BINDER

For Suspender Tabs

No.	Plate	Name
225633	10312	Binder on Shank, in sizes $\frac{1}{2}$ and $\frac{3}{8}$ inch
207075	13380	Feed Dog
229880	13356	Presser Foot
207076	13380	Throat Plate, 50 needle hole, for needle sizes 14 and 15, with 202534, 202619 and two 200583u..

BINDER (BIAS)

225634	10312	Binder on Shank, for $\frac{1}{2}$, $\frac{3}{8}$ and $\frac{5}{8}$ inch
--------	-------	---

BINDER (ADJUSTABLE)

For Hats

225610	10309	Bed
225612	10309	Folder with 225610
225613	10309	" Slide with 200768e
200768e	10309	" " Adjusting Screw
225614	10309	" " " Thumb Nut Guide
226077	---	" " " " " "
		225614 with 226112
200164b	10309	Folder Slide Adjusting Thumb Nut Guide Screw
226112	10309	Folder Slide Adjusting Thumb Nut Sleeve with 225998
225998	10309	Folder Slide Adjusting Thumb Nut Sleeve Screw Center
225615	10309	Folder Slide Cap
200164b	10309	" " " Screw
225616	10309	Guide (front)
200893b	11598	" " Thumb Screw
225618	10309	" (back, lower)
225619	10309	" (back, upper)
200893b	11598	" (back) Thumb Screw
225620	10309	Pressure Spring
200176b	11598	" " Screw

No.	Plate	Name
225623	10310	Binder complete, Nos. 200176b, 225612, 225613, 225615, 225616, 225618 to 225620, 226077, two each 200164b and 200893b

225977 10310 Feed Dog

225621 10310 Presser Foot

225622 10310 Throat Plate, 53 needle hole, for needle sizes 12 and 13, with 202534, 202619 and two 200582u..

Note: Nos. 225621, 225622 and 225977 should be used with but not included in No. 225623.

CORDERS

WHEN ORDERING SEND SAMPLES OF CORD

CORDER

For Top Cording

For 8, 9, 10, 12, 14 or 16 cords to the inch, as ordered

No.	Plate	Name
225684	10322	Arm with 200340c, 201533e and three 225686
200340c	11598	Arm Adjusting Screw
201533e	11598	" " " Nut
225685	10322	" Bracket with 200851B
225687	10322	" " Hinge Pin
200851B	10322	" " Locking Thumb Screw.
200035E	11598	" " Screw
225689	10322	" " Clamp Washer ...
225686	10322	" Cord Guide
225688	11599	Arm and Bracket complete, Nos. 225684, 225685, 225687, 225689 and two 200035E
203136	13354	Feed Dog
202368	10259	Presser Foot (deep grooved) (grooved to left of needle hole)
202816	10391	Throat Plate, 50 needle hole, for needle sizes 14 and 15, with 202534, 202619 and two 200582H..

CORDER

For Top and Bottom Cording

For 8, 9, 10, 12, 14 or 16 cords to the inch, as ordered

225688	11599	Arm and Bracket complete, Nos. 225684, 225685, 225687, 225689 and two 200035E
203173	13354	Feed Dog
225690	10923	Presser Foot
226000	13357	Throat Plate, 53 needle hole, for needle sizes 12 and 13, with 202534, 202619 and two 200583H..

BOW CORDER

For Sunbonnets, etc.

No.	Plate	Name
225693	10325	Presser Foot and Bracket
Note: When ordering 225693 send sample cord.		
225695	---	Presser Foot Bracket Bow, 8 in. long, with 225698 and 231149 ...
225698	10325	Presser Foot Bracket Bow Cord Tube (order size wanted)
231149	---	Presser Foot Bracket Bow Cord Tube (short)
200185D	10325	Presser Foot Bracket Bow Screw
206482	13356	" " " " " Washer
225699	10325	Corder, 8 in. bow, complete, Nos. 225693, 225695, two each 200185D and 206482

BOW CORDER

For Infants' Caps, Etc.

225696	10325	Presser Foot Bracket Bow, 6 in. long, with 225698 and 231149 ...
225930	10325	Corder, 6 in. bow, complete, Nos. 225693, 225696, two each 200185D and 206482

BOW CORDER

For Extra Fine Work

225697	---	Presser Foot Bracket Bow, 4 in. long, with 225698 and 231149 ...
225940	10325	Corder, 4 in. bow, complete, Nos. 225693, 225697, two each 200185D and 206482

Note: When ordering 225699, 225630 or 225940 send sample of cord on material to be used.

CORD COVERING ATTACHMENT

No.	Plate	Name
230744	14650	Cord Guide and Strip Folder
200137D	10359	" " " " " Screw
201566B	13357	" " " " " Thumb Nut
230625	13354	Feed Dog
230745	14650	Presser Foot
35983	11598	Strip Wire
230746	14650	Tape Tension Frame with six 229000
229000	13380	" " Pin
230749	14650	Throat Plate, 50 needle hole, for needle sizes 14 and 15, with 201566B, 202534 and two 200583H
230751	---	Cord Covering Attachment com- plete, Nos. 35983, 200137D, 230625, 230744 to 230746 and 230749

FOLDERS

For Open Shirt Fronts

No.	Plate	Name
226165	10923	Presser Folder, for folding a $\frac{3}{16}$ in. fold from the left, which is to be stitched near the edge

FOLDERS (DOUBLE)

For Shirt Work

225729	11598	Folder, turns the upper edge under and the under edge over, for M, H, XXH or XXXH material
225962	10511	Folder on Shank, folds the top goods under and the under goods over and guides a piece of goods between them from the left

Note: Send sample of goods to be folded.

BENCH TUCK FOLDER

230930	13376	Bed Plate (back)
202293	10912	Feed Dog, 21 teeth (22 teeth to the inch)
203198	13355	Presser Foot, for laying tucks
203199	13355	" " " " narrow tucks
203200	13355	" " " " tucks toward the needle
36387	5884	Space Guide
35510	5884	" " Base with 35512, 35514 and two 1426E
402D	5885	Space Guide Base Screw
35511	5885	" " Indicator
35512	5885	" " Pin
35513	5885	" " Stop (left)
35514	5885	" " " " Guide Pin..
1426E	5885	" " " " Screw Stud
1657D	5885	" " " " Thumb Nut
17718	5885	" " " " " "
		Washer
35515	5885	Space Guide Stop (right)
1426E	5885	" " " " Screw Stud
1657D	5885	" " " " Thumb Nut
17718	5885	" " " " " "
		Washer

No.	Plate	Name
287D	5885	Space Guide Thumb Screw
36388	---	Space Guide complete, Nos. 287D, 35510, 35511, 35513, 35515, 36387, two each 1657D and 17718
202827	10390	Throat Plate, 53 needle hole, for needle sizes 12 and 13, with 202534, 202619 and two 200583H..
35517	5883	Tuck Guide Arm
1177D	5885	" " " Screw
35518	5883	" " " Base
50134E	5885	" " " Screw Stud
36389	5883	" " " Bracket
307C	5885	" " " Screw Center ...
1513J	5885	" " " " " Nut
36390	5885	" " " Spring
36391	5884	" " " " Plate
9D	5885	" " " " Screw
423C	5885	" " " Stop Screw
1520E	5885	" " " " " Nut ..
36392	5883	" " " Frame
36393	5885	" " " Spring
1510E	5885	" " " " Nut
35524	5885	" " " " Washer ...
803C	5885	" " " Stop Screw
1520E	5885	" " " " " Nut ..
35511	5885	" " " Indicator
35525	5883	" " " Plate
1115F	5885	" " " Screw
36394	---	Tuck Guide complete, Nos. 9D, 423C, 803C, 1510E, 35511, 35517, 35518, 35524, 35525, 36389 to 36393, 50134E, two each 307C, 1115E, 1177D, 1513J, 1520E and three wood screws 1½ in., No. 10
244041	---	Adjustable Bench Tuck Folder com- plete, Nos. 36388, 36394, 202293, 202827, 203198 to 203200, 230930 and two 402D

TUCK FOLDER

225923	10321	Folder
200090C	11598	" Adjusting Screw
225924	10321	" Arm
200836E	11598	" Screw Stud
200318H	11598	" " " Adjusting Screw
206840	11598	" " " " " "
		Spring Washer

No.	Plate	Name
201564B	11598	Folder Screw Stud Thumb Nut
202600	11598	" " " " "
		Washer
203198	13355	Presser Foot, for laying tucks
203199	13355	" " " " narrow tucks
203200	13355	" " " " tucks toward the needle
225926	10321	Space Gauge
200843E	---	" " Stop Screw Stud
201562B	---	" " " " " Thumb Nut
202603	10346	Space Gauge Stop Screw Stud Thumb Nut Washer
225927	10321	Tuck Folder complete, Nos. 200090C, 200318H, 200836E, 200843E, 201562B, 201564B, 202600, 202603, 206840, 225923, 225924 and 225926

HEMMERS

HEMMER FEET

No.	Plate	Name
225800	10354	Hemmer Foot, for lace, for $\frac{1}{8}$ in. hem
225502	10354	Hemmer Foot, for $\frac{1}{8}$ in. hem
225805	10354	" " " lace, for $\frac{1}{8}$ in. hem
225504	10354	Hemmer Foot, for $\frac{1}{4}$ in. hem
206974	11600	" " " $\frac{1}{4}$ in. hem
225806	10354	" " " $\frac{3}{8}$ in. hem
225503	10354	" " " lace, for $\frac{3}{8}$ in. hem
225801	10393	Hemmer Foot, for $\frac{1}{4}$ in. hem, for thick soft woolens and felling corset seams
225740	10393	Hemmer Foot, for $\frac{1}{2}$ in. hem
225802	10393	" " " $\frac{3}{8}$ and $\frac{1}{2}$ in. hem, for cord guiding, sews a cord within the hem
229843	11600	Hemmer Foot, for $\frac{3}{8}$ and $\frac{1}{2}$ in. hem, for cord guiding, sews a cord within the hem

Note: Specify width wanted on order.

PRESSER FOOT CLEFT HOLDERS

206842	13356	Presser Foot Cleft Holder
225865	10355	" " " " for use with 206998, for interchangeable Pressers and Hemmers

HEMMERS

225807	10355	Hemmer, for $\frac{1}{8}$ in. hem
225808	10355	" " " $\frac{1}{4}$ in. hem, for felling
225809	10355	" " " $\frac{1}{2}$ in. hem
225810	10355	" " " $\frac{3}{8}$ in. hem
225811	10355	" " " $\frac{1}{4}$ in. hem
225812	10355	" " " $\frac{3}{8}$ in. hem, for "L" shaped Feed Dog 202283 only ..

No.	Plate	Name
225813	10355	Hemmer, for $\frac{1}{8}$ in. hem (Troy, long)
225814	10355	" " " $\frac{1}{4}$ in. hem (Troy, short)
225815	10355	" " " $\frac{3}{8}$ in. hem
231168	10355	" " " $\frac{1}{4}$ in. hem
225816	10355	" " " $\frac{1}{4}$ in. hem
225817	10355	" " " $\frac{3}{8}$ in. hem

HEMMERS ON SHANK

225803	10353	Hemmer on Shank, for hems of the following widths: $\frac{1}{8}$, $\frac{3}{16}$, $\frac{1}{4}$, $\frac{5}{16}$, $\frac{3}{8}$, $\frac{7}{16}$ and $\frac{1}{2}$ inch
--------	-------	--

Note: Specify width wanted on order.

225804	10353	Hemmer on Shank, for hems of the following widths: $\frac{1}{2}$, $\frac{5}{8}$, $\frac{11}{16}$, $\frac{3}{4}$, $\frac{13}{16}$, $\frac{7}{8}$, $\frac{15}{16}$ and 1 inch
--------	-------	---

Note: Specify width wanted on order.

HEMMER

For Sheets, Etc., Sizes from $\frac{1}{2}$ to $3\frac{1}{4}$ inches

Note: Specify width wanted on order.

225794	---	Hemmer on Shank
200160R	11600	" Adjusting Screw
226663	11600	" " " Washer ...
203075	10935	" Base Plate with 225706 ...
230000	11599	" " " 203075 with 200246R, 201525E, 225708, 226663 and two 200160R
225706	---	Hemmer Base Plate Position Pin..
200246R	11600	" " " Screw
201525E	10245	" " " " Nut
225708	10344	" " " Spring
225796	10321	Hemmer complete, for $\frac{1}{2}$ to $3\frac{1}{4}$ in., Nos. 225794 and 230000

HEMMER

For Hemming Pillow Cases or Other Tubular Work

For hems from $\frac{1}{2}$ to 4 inches

Note: Specify width wanted on order.

No.	Plate	Name
203075	10935	Base Plate with 225706
230000	11599	" " 203075 with 200246B, 201525E, 225708, 226663 and two 200160B
225706	—	Base Plate Position Pin
200246B	11600	" " Screw
201525E	10245	" " " Nut
225708	10344	" " Spring
*225764	—	Hemmer on Shank
*225767	—	" Plate with 200857E and 225586
226663	11600	Hemmer Plate Clamp Washer....
200160B	11600	" " " " Screw
225586	11600	" Shank Position Pin
200857E	11600	" " Screw Stud
225765	10344	" " Switch Handle with 200397C and 201609
*201609	—	Hemmer Shank Switch Handle Stud
200397C	13378	" " " " " "
		Set Screw
204004	11600	Hemmer Shank Switch Handle Washer
225769	10321	Hemmer complete, for hems $\frac{1}{2}$ to 4 in., Nos. 204004, 225764, 225765, 225767 and 230000

HEMMER ON SWING BRACKET

225970	11600	Hemmer on Shank, made for hems of the following widths: $\frac{1}{8}$, $\frac{1}{4}$, $\frac{1}{2}$, $\frac{3}{8}$, $\frac{1}{2}$, $\frac{3}{4}$ and $\frac{1}{2}$ inch
--------	-------	--

Note: Specify width wanted on order.

226110	11599	Hemmer Swing Bracket with 200369D and 200862E
226977	—	Hemmer Swing Bracket 226110 with 200157B, 201526E, 201563B, 225734, 225735 and 226071
200369D	11600	Hemmer Swing Bracket Adjusting Screw

No.	Plate	Name
225735	10335	Hemmer Swing Bracket Base
200157B	13380	" " " " Hinge Screw
201526E	10335	Hemmer Swing Bracket Base Hinge Screw Nut
226071	10335	Hemmer Swing Bracket Base Hinge Screw Spring Washer
200862E	11600	Hemmer Swing Bracket Base Screw Stud
201563B	10335	Hemmer Swing Bracket Base Screw Stud Thumb Nut
225734	10335	Hemmer Swing Bracket Base Screw Stud Washer
225973	—	Hemmer on Swing Bracket com- plete, Nos. 225970 and 226977 ..

REVERSE HEMMER

For Turning the Hem Under

225776	10346	Hemmer, for $\frac{3}{2}$ in. hem
225777	10346	" Shank
200142B	10346	" " Screw
202603	10346	" " " Washer
225778	10346	Hemmer complete, Nos. 200142B, 202603, 225776 and 225777

REVERSE HEMMER

For Hemming and Stitching on Lace

225779	10347	Hemmer on Shank, for $\frac{3}{2}$ in. hem
225780	10347	" Lace Guide
200142B	10346	" Shank Screw
202603	10346	" " " Washer
225781	10347	Hemmer (reverse) complete, Nos. 225779, 225780, two each 200142B and 202603

HEMMER

For Hemming Tubular Articles with Movable Folder
for Finishing Off. State Gauge Required

Made for hems from $\frac{1}{2}$ to $1\frac{1}{2}$ in., in steps of $\frac{1}{32}$ inch

No.	Plate	Name
203075	10935	Base Plate with 225706
230000	11599	" " 203075 with 200246B, 201525E, 225708, 226663 and two 200160B
225706	—	Base Plate Position Pin
200246B	11600	" " Screw
201525E	10245	" " " Nut
225708	10344	" " Spring
225787	11599	Hemmer on Shank
200460B	—	" Adjusting Thumb Screw
228043	11600	" " " " " Washer
230864	11599	Hemmer Plate
226663	11600	" " Clamp Washer
200160B	11600	" " " " Screw
230865	—	Hemmer complete, Nos. 200460B, 225787, 228043, 230000 and 230864

HEMMER

For Hemming Tubular Articles with Movable Folder
for Finishing Off. State Gauge Required

Made for hems from $\frac{1}{4}$ to 1 in., in steps of $\frac{1}{32}$ inch

225790	10350	Hemmer on Shank
225791	10350	" Base Plate with 200838E ..
200838E	10350	" " " Screw Stud
201557B	10350	" " " " " Nut
225792	10350	Presser Foot
225793	10350	Hemmer complete, for hems $\frac{1}{4}$ to 1 in., Nos. 201557B and 225790 to 225792

PLAITER

FOLDS TUCK PLAITS

No.	Plate	Name
225827	10357	Base Plate
225828	10357	" " Arm Bracket with two 200383c
225829	10358	Base Plate Arm Shaft
200383c	10246	" " " " Set Screw ..
200579E	10359	" " Set Screw
225830	10358	Folder Guide
200110B	10359	" " Set Screw
225831	10358	" Bracket
225919	—	" " 225831 with 225830, 225833, two each 200110B and 200137c
225909	10358	Folder Bracket Guide Stop with 200382c
200382c	10359	Folder Bracket Guide Stop Set Screw
226164	10359	Folder Bracket Stop Collar with 200113F
200113F	10359	Folder Bracket Stop Collar Set Screw
225833	10358	Folder Bracket Stop Spring
200137c	10359	" " " " Screw
225835	10358	Guide
225836	10358	" Adjustable Stop
200169B	10359	" " " Screw
200845B	10359	" Screw Stud
200651B	10359	" " " Handle Screw ..
226163	10359	" " " Washer
225839	10358	Space Guide
225840	10358	" " Bracket
200417A	10359	" " " Position Screw
201531E	13380	" " " " " Nut
226164	10359	Space Guide Bracket Stop Collar with 200113F
200113F	10359	Space Guide Bracket Stop Collar Set Screw
200462B	10245	Space Guide Bracket Thumb Screw
200110B	10359	" " Set Screw
225841	—	Space Guide complete, Nos. 200417A, 200462B, 201531E, 225839, 225840 and two 200110B

No.	Plate	Name
225842	10321	Plaiter complete, Nos. 200169B, 200651B, 200845B, 225827 to 225829, 225835, 225836, 225841, 225909, 225919, 226163, two 226164 and three 200579E

RUFFLER

With Separating Blade and Disengaging Lever to Switch
the Ruffling Blade Out of or In to Action for In-
termittent Ruffling Such as Yoking Shirts, Etc.

No.	Plate	Name
225843	10360	Driving Lever
200255D	10360	" " Hinge Screw
225844	10360	" " Spring
201554D	10360	" " Adjusting Nut
225845	10360	Frame with 225959
225846	10361	Guide (left) with 225856 and two 200178D
225847	10361	Guide (right) with 225856 and two 200178D
		Note: Nos. 225846 and 225847 are sent only on order.
200126D	10361	Guide Screw
225848	10360	Needle Bar Collar (for driving 225843)
201856	11600	Needle Bar Collar Roller
200615F	10360	" " " Screw ...
225850	10360	Needle Bar Collar complete, Nos. 200615F, 201856 and 225848
225851	10360	Ruffling Blade
225852	10360	" " Clamp
200175H	10360	" " " Screw
225853	10360	" " Lever with 225852, 225854 and two 200175H
200465F	10360	Ruffling Blade Lever Adjusting Thumb Screw
225854	10360	Ruffling Blade Lever Adjusting Thumb Screw Bushing
201583C	10360	Ruffling Blade Lever Adjusting Thumb Screw Wing Nut
225855	10360	Ruffling Blade Switching Lever
200310C	10360	" " " " Hinge Screw
225959	10360	Ruffling Blade Switching Lever Stop Pin
225856	10361	Separating Blade
200178D	11600	" " Screw
225857	10361	Ruffler complete, Nos. 200126D, 200255D, 200310C, 200465F, 201554D, 201583C, 225843 to 225845, 225850, 225851, 225853 and 225855

RIBBON REELS

No.	Plate	Name
226200	—	Ribbon Reel (6 in. diam.) with 225666
226211	—	Ribbon Reel (holding projection, 6 $\frac{1}{2}$ in. diam.) with 213540 and 226212
225663	10321	Ribbon Reel (9 in. diam.) with 225666
226212	11598	Ribbon Reel Center Pin
213540	13380	" " " " Washer ..
225664	11598	" " Supporting Spindle ..
225665	—	" " " " Base with 225664 and two wood screws $\frac{3}{4}$ in., No. 7
230471	—	Ribbon Reel Supporting Spindle Hub
225666	—	Ribbon Reel Supporting Spindle Hub 230471 with 225980
225980	—	Ribbon Reel Supporting Spindle Hub Base
226201	—	Ribbon Reel (6 in. diam.) complete, Nos. 225665 and 226200
225976	—	Ribbon Reel (9 in. diam.) complete, Nos. 225663 and 225665

WOOD BASE

FOR USE WITH TUCK FOLDER

79627	—	Bench Stand Section (back) with two each 20022, 27878, 44244, wood screws 1 $\frac{1}{4}$ in., No. 14 and 3 $\frac{1}{2}$ in., No. 14
79626	—	Bench Stand Section (front) with wood screw 1 $\frac{1}{2}$ in., No. 12, two each 20022, 27878 and wood screws 3 $\frac{1}{2}$ in., No. 14
228170	—	Drip Pan
44244	—	Machine Hinge Plate
20022	—	" Rest (felt)
27878	—	" " Rivet
202730	11599	Knee Lifter Rock Lever Rod, 8 in. long, with 202456
*202456	—	Knee Lifter Rock Lever Rod Cap or Oil Guard
79628	—	Bench Stand (sectional) complete, Nos. 79626 and 79627

NUMERICAL LIST OF PARTS
FOR
MACHINES
Nos. 61w52, 61w72, 61w84
and 61w154

NUMERICAL LIST OF PARTS

No.	Plate	Name
90	5885	Tuck Folder Tuck Guide Bracket Spring Screw, for 36394
287d	5885	Tuck Folder Space Guide Thumb Screw, for 36388
307	5885	Tuck Folder Tuck Guide Bracket Screw Center, for 36394
356c	14171	Knee Lifter Rock Shaft Knee Arm Hub Set Screw, for 2766
356c	14171	Knee Lifter Rock Shaft Knee Plate Set Screw, for 2767
356c	14171	Knee Lifter Rock Shaft Lifting Lever Set Screw, for 228238
356c	14171	Knee Lifter Rock Shaft Stop Dog Set Screw, for 2770
402d	5885	Tuck Folder Space Guide Base Screw, for 24494
423	5885	Tuck Folder Tuck Guide Bracket Stop Screw, for 36394
803	5885	Tuck Folder Tuck Guide Frame Stop Screw, for 36394
1115i	5885	Tuck Folder Tuck Guide Screw, for 36394
1177d	5885	Tuck Folder Tuck Guide Arm Screw, for 36394
1426c	5885	Tuck Folder Space Guide Stop (left) Screw Stud, for 35510
1426c	5885	Tuck Folder Space Guide Stop (right) Screw Stud, for 35510
1507r	13380	Knee Lifter Rock Shaft Knee Arm Lock Nut, for 228563
1510e	5885	Tuck Folder Tuck Guide Frame Spring Nut, for 36394
1513d	5885	Tuck Folder Tuck Guide Bracket Screw Center Nut, for 36394
1520e	5885	Tuck Folder Tuck Guide Bracket Stop Screw Nut, for 36394
1520c	5885	Tuck Folder Tuck Guide Frame Stop Screw Nut, for 36394
1657d	5885	Tuck Folder Space Guide Stop (left) Thumb Nut, for 36388
1657d	5885	Tuck Folder Space Guide Stop (right) Thumb Nut, for 36388
2102	10881	Bobbin Winder Tension Disc, for 225462

No.	Plate	Name
2763	14171	Knee Lifter Rock Shaft, for 228242 and 228243
2765	14171	Knee Lifter Rock Shaft Knee Arm, for 2768
2766	14171	Knee Lifter Rock Shaft Knee Arm Hub with 356c, for 2768 and 228243
2767	14171	Knee Lifter Rock Shaft Knee Plate with 356c, for 2768 and 228243 ..
2768	-	Knee Lifter Rock Shaft Knee Arm 2765 with 2766 and 2767, for 228243
2770	14171	Knee Lifter Rock Shaft Stop Der with 356c, for 228242 and 228243
7539	14171	Knee Lifter Rock Shaft Hanger with two wood screws 1 in., No. 10, for 228242 and 228243
8073	14171	Knee Lifter Rock Shaft Lifting Lever Rod Swivel Spring Plunger, for 228239
12361	13380	Machine Hinge Connection
17718	5885	Tuck Folder Space Guide Stop (left) Thumb Nut Washer, for 36388
17718	5885	Tuck Folder Space Guide Stop (right) Thumb Nut Washer, for 36388
20022	-	Machine Rest, for 79626 and 79627
20093	14171	Knee Lifter Rock Shaft Hanger (front) with two wood screws 1 in., No. 10, for 228242 and 228243
26608	13355	Presser Foot (glass)
27878	-	Machine Rest Rivet, for 79627
35510	5884	Tuck Folder Space Guide Base with 35512, 35514 and two 1426e, for 36388
35511	5885	Tuck Folder Space Guide Indicator, for 36388
35511	5885	Tuck Folder Tuck Guide Indicator, for 36394
35512	5885	Tuck Folder Space Guide Pin, for 35510
35513	5885	Tuck Folder Space Guide Stop (left), for 36388
35514	5885	Tuck Folder Space Guide Stop (left) Guide Pin, for 35510
35515	5885	Tuck Folder Space Guide Stop (right), for 36388
35517	5883	Tuck Folder Tuck Guide Arm, for 36394
35518	5883	Tuck Folder Tuck Guide Base, for 36394

No.	Plate	Name
35521	5885	Tuck Folder Tuck Guide Frame Spring Washer, for 36394
35525	5883	Tuck Folder Tuck Guide Plate, for 36394
35983	14598	Strip Wire, for 230751
36387	5884	Tuck Folder Space Guide, for 36388
36388	-	Tuck Folder Space Guide complete, Nos. 287c, 35510, 35511, 35513, 35515, 36387, two each 1657a and 1648, for 244011
36389	5883	Tuck Folder Tuck Guide Bracket, for 36394
36390	5885	Tuck Folder Tuck Guide Bracket Spring, for 36394
36391	5884	Tuck Folder Tuck Guide Bracket Spring, Plate, for 36394
36392	5883	Tuck Folder Tuck Guide Frame, for 36394
36393	5885	Tuck Folder Tuck Guide Frame Spring, for 36394
36394	-	Tuck Guide complete, Nos. 9d, 123c, 833c, 1510c, 35511, 35517, 35518, 35521, 35525, 36389 to 36393, 36394, two each 306c, 1415c, 1417c, 1419c, 1520c, and three wood screws 1½ in., No. 10, for 244011
41400	12152	Machine Rest Pin (wood)
44244	-	Hinge Plate, for 79627
50134c	5885	Tuck Folder Tuck Guide Base Screw Stud, for 36394
79626	-	Bench Stand Section (front) with wood screw 1½ in., No. 12, two each 20022, 27878 and wood screws 3½ in., No. 14, for 79628
79627	-	Bench Stand Section (back) with two each 20022, 27878, 44244, wood screws 1½ in., No. 14 and 3½ in., No. 14, for 79628
79628	-	Bench Stand (sectional) complete, Nos. 79626 and 79627
120312	12153	Oilor (copper plated) with 120343 ..
120343	12153	" Spout, 3½ in. long, for 120342 ..
200040c	10245	Arm Screw
200035c	14598	Corder Arm Bracket Screw, for 225688
200038c	10245	Feed Bar Slide Block Crank Pinch Screw, for 202298
200038c	10245	Feed Driving Connection Crank Pinch Screw, for 202298

No.	Plate	Name
200043c	10246	Feed Driving Rock Shaft Center Set Screw
200045c	10246	Feed Lifting Rock Shaft Center Set Screw
200047c	10381	Tuck Marker Shaft Driving Crank Pinch Screw, for 225939
200054e	10246	Feed Driving Connection Pinch Screw, for 202297
200054E	10246	Feed Lifting Connection Pinch Screw, for 202306
200056E	10884	Bobbin Winder Stop Latch Screw, for 225382
200061c	13378	Tension Stud Set Screw
200074E	13378	Presser Foot Screw, for 202335
200079H	13378	Spool Holder Wire Hinge Screw, for 204297
200082D	10881	Bobbin Winder Tension Bracket Screw, for 225382
200086c	10248	Needle Bar Connecting Stud Pinch Screw, for 202329
200086E	10248	Presser Bar Position Guide Lever Pinch Screw, for 202338
200086c	10248	Bobbin Case Lever Driving Eccentric Connection Lever Pinch Screw, for 206730
200090c	11598	Tuck Folder Adjusting Screw, for 225927
200106E	10245	Feed Dog Screw, for 203121
200110B	10359	Plaiter Folder Guide Set Screw, for 225919
200110B	10359	Plaiter Space Guide Set Screw, for 225841
200113E	10359	Plaiter Folder Bracket Stop Collar Set Screw, for 226161
200113E	10359	Plaiter Space Guide Bracket Stop Collar Set Screw, for 226164
200125E	10381	Tuck Marker Set Screw, for 225936
200126D	10361	Ruffler Guide Screw, for 225857
200132e	10247	Take-up Lever Oiling Felt Screw
200132E	10247	Thread Controller Spring Stop Screw
200137D	10359	Cord Guide and Strip Folder Screw, for 230751
200137c	10359	Plaiter Folder Bracket Stop Spring Screw, for 225919
200141E	10248	Needle Set Screw, for 202326
200142B	10346	Hemmer Shank Screw, for 225778 and 225781
200142E	10346	Tuck Marker Tuck Creaser Plate Spring Screw, for 225707

No.	Plate	Name
200145c	11671	Hook Washer Screw, for 244011 and 244023
200157E	13380	Attachment Screw
200157E	13380	Hemmer Swing Bracket Base Hinge Screw, for 226977
200160a	11600	Hemmer Adjusting Screw, for 230000
200160c	11600	Hemmer Plate Clamp Washer Screw, for 230000
200161D	10217	Needle Bar Connecting Link Oil Guard Screw
200164a	10309	Folder Slide Adjusting Thumb Nut Guide Screw, for 225623
200164a	10309	Folder Slide Cap Screw, for 225623
200169c	10359	Plaiter Guide Adjustable Stop Screw, for 225842
200172B	10381	Tuck Marker Tuck Creaser Slide Spring Screw, for 225707
200175a	10360	Presser Foot Spring Guide Screw, for 203037 and 229871
200175a	10360	Presser Foot Strip Guide Bar Plate Screw, for 202366
200175a	10360	Ruffling Blade Clamp Screw, for 225853
200175b	11598	Pressure Spring Screw, for 225623
200178b	11600	Ruffling Separating Blade Screw, for 225846 and 225847
200179a	10361	Tuck Marker Guide Tuck Smoothing Spring Screw, for 244028
200185a	10325	Presser Foot Bracket Bow Screw, for 225699, 225930 and 225940
200205c	10245	Feed Bar Slide Block Hinge Screw, for 203124
200246c	11600	Hemmer Base Plate Screw, for 230000
200255a	10360	Ruffler Driving Lever Hinge Screw, for 225857
200260D	13375	Presser Bar Lifting Releasing Lever Bracket Guide Screw
200262a	10248	Knee Lifter Connection Lever Hinge Screw, for 244035 and 244037
200262a	10248	Knee Lifter Lifting Lever Hinge Screw
200274c	10381	Tuck Marker Shaft Driving Crank Roller Screw Stud, for 201813
200278a	10214	Arm Cap Screw
200299H	10884	Bobbin Winder Stop Latch Trip Lever Hinge Screw, for 225382
200310c	10360	Ruffling Blade Switching Lever Hinge Screw, for 225857

No.	Plate	Name
200318u	11598	Tuck Folder Screw Stud Adjusting Screw, for 225927
200327c	10244	Arm Shaft Connection Belt Pulley Set Screw, for 202252
200328c	10244	Balance Wheel Position Screw, for 202255
200333c	13378	Bobbin Case Lever Bushing Set Screw, for 244021
200335c	10244	Balance Wheel Set Screw, for 202255
200335c	10244	Needle Bar Crank Set Screw, for 202328
200338c	10244	Arm Shaft Bushing Set Screw
200340c	11598	Corder Arm Adjusting Screw, for 225681
200346c	10245	Hook Shaft Bushing (back) Set Screw
200346c	10245	Hook Shaft Bushing (front) Set Screw
200352c	10248	Needle Bar Bushing Set Screw
200352c	10248	Presser Bar Bushing Set Screw
200352c	10248	" " Position Guide Set Screw
200355u	10252	Thread Guide Set Screw
200357e	10244	Arm Shaft Oil Packing Stop Screw, for 202249 and 202250
200368u	13378	Thread Guide Set Screw
200368u	13378	" Retainer Stud Set Screw
200369d	11690	Hemmer Swing Bracket Adjusting Screw, for 226110
200374c	13375	Needle Bar Connecting Link Stud Set Screw, for 202328
200380c	13378	Bobbin Case Lever Driving Eccentric Set Screw, for 244018
200380c	13378	Bobbin Winder Pulley Set Screw, for 202473
200382c	10359	Feed Lifting Connection Eccentric Set Screw, for 202307
200382c	10359	Plaiter Folder Bracket Guide Stop Set Screw, for 225999
200383c	10246	Feed Driving Eccentric Regulating Screw Check Screw
200383c	10246	Plaiter Base Plate Arm Shaft Set Screw, for 225828
200383c	10246	Take-up Lever Hinge Stud Set Screw
200397c	13378	Hemmer Shank Switch Handle Stud Set Screw, for 225765
200417A	10359	Plaiter Space Guide Bracket Position Screw, for 225841

No.	Plate	Name
200428c	10248	Needle Bar Crank Position Screw, for 202328
200429c	10246	Feed Driving Eccentric Regulating Screw
200437c	10246	Feed Lifting Connection Eccentric Position Screw, for 202307
200444c	13375	Bobbin Case Lever Driving Eccentric Spot Screw, for Machines Nos. 61w84 and 61w154
200444c	13375	Hook Counter Balance Position Screw, for 244013 and 244018
200459d	13375	Cloth Guide Thumb Screw, for Machines Nos. 61w52 and 61w72
200460c		Hemmer Adjusting Thumb Screw, for 230865
200462b	10245	Face Plate Thumb Screw
200462b	10245	Plaiter Space Guide Bracket Thumb Screw, for 225841
200465c	10359	Ruffling Blade Lever Adjusting Thumb Screw, for 225857
200469c	13378	Tuck Marker Guide Thumb Screw, for 244031
200475b	13378	Presser Bar Thumb Screw Thumb Set Screw
200481b	10381	Tuck Marker Shaft Stop Collar Thumb Screw, for 225943
200488c	13380	Presser Foot Strip Guide Thumb Screw, for 231235
200492b	13378	Presser Bar Thumb Screw (pressure regulating)
200502b	10246	Arm Shaft Bushing (front) Oil Packing Thumb Screw
200529c	14171	Knee Lifter Rock Lever Rod Set Screw, for 228241
200543b	13356	Presser Foot Screw, for 206998
200545c	10245	Feed Driving Connection Hinge Screw
200545c	10215	Feed Lifting Connection Hinge Screw
200567u		Tuck Marker Shaft Bracket Base Plate Screw, for Machine No. 61w72
200575u	13378	Spool Holder Base Screw
200577u	10245	Bed Plate (back) Screw, for Machines Nos. 61w52, 61w84 and 61w154
200577u	10215	Throat Plate Screw
200579c	10359	Tuck Marker Shaft Bracket Screw, for 225937

No.	Plate	Name
200579E	10359	Plaiter Base Plate Set Screw, for 225842
200582H	10252	Thread Guide Screw
200582H	10252	Throat Plate Bobbin Case Stop Screw, for 202811, 202816, 203093 and 225622
200583H	13378	Bobbin Case Lever Driving Eccentric Washer Screw, for 244019
200583H	13378	Throat Plate Bobbin Case Stop Screw, for 202812, 202815, 202947 to 202819, 202822, 202824, 202827 to 202831, 202951, 202969, 203033, 203056, 203073, 203111, 203113, 206975, 207076, 226000, 230749 and 230833
200592C	13378	Bobbin Case Tension Spring Screw, for 206733
200594C	11671	Bobbin Case Tension Spring Screw, for 202533
200596F	11671	Hook Gib Screw, for 244014 and 244023
200602E	10244	Arm Shaft Connection Belt Pulley Position Screw, for 202952
200607C	10246	Feed Driving Eccentric Regulating Bracket Plunger Spring Stop Screw
200614C	11671	Hook Gib Hinge Screw, for 244011 and 244023
200615F	10360	Ruffler Needle Bar Collar Roller Screw, for 225850
200625F	10247	Tension Stud with 204925, for 20409
200641C	10246	Feed Bar Hinge Screw (driving), for 203122 and 206860
200651B	10359	Plaiter Guide Screw Stud Handle Screw, for 225842
200653C	13375	Presser Bar Lifter Hinge Screw
200768E	10309	Folder Slide Adjusting Screw, for 225613
200836E	11598	Tuck Folder Screw Stud, for 229927
200838E	10350	Hemmer Base Plate Screw Stud, for 225791
200842F	13378	Take up (auxiliary) Screw
200843E	—	Tuck Folder Space Gauge Stop Screw Stud, for 225927
200845B	10359	Plaiter Guide Screw Stud, for 225842
200851B	10222	Corder Arm Bracket Locking Thumb Screw, for 225685
200852B	10381	Tuck Marker Shaft Rock Lever Pinch Screw, for 225942

No.	Plate	Name
200857F	11600	Hemmer Shank Screw Stud, for 225767
200862F	11600	Hemmer Swing Bracket Base Screw Stud, for 226110
200893B	11598	Guide (back) Thumb Screw, for 225623
200893B	11598	Guide (front) Thumb Screw, for 225623
200904F	13355	Presser Foot Adjustable Spring Guide Screw, for 206790
200964F	13363	Bobbin Case Latch Stop Screw, for 206734
200983C	11671	Bobbin Case Tension Spring Regulating Screw, for 202533
201014	10245	Feed Driving Eccentric Regulating Bracket Hinge Screw, for 203134
201014	10245	Feed Driving Eccentric Regulating Bracket Stop Screw, for 203134
201043F	13363	Bobbin Case Tension Spring Regulating Screw, for 206733
201048C	13375	Hook Shaft Connection Belt Pulley Set Screw, for 202323
201194F	13363	Bobbin Case Lever Driving Eccentric Connection Lever Hinge Screw Stud, for 244020
201499C	10884	Bobbin Winder Tension Stud, for 225461
201518C	10245	Feed Bar Slide Block Hinge Screw Nut, for 203124
201518C	10245	Feed Driving Connection Hinge Screw Nut
201518C	10245	Feed Lifting Connection Hinge Screw Nut
201520	10246	Feed Bar Hinge Screw Nut, for 203122 and 206860
201524	13378	Bobbin Case Lever Driving Eccentric Connection Lever Hinge Screw Stud Nut, for 244020
201525C	10245	Hemmer Base Plate Screw Nut, for 230000
201525F	10245	Feed Driving Eccentric Regulating Bracket Hinge Screw Nut, for 203134
201525F	10245	Feed Driving Eccentric Regulating Bracket Stop Screw Nut, for 203134
201526F	10335	Hemmer Swing Bracket Base Hinge Screw Nut, for 226977
201531F	13380	Plaiter Space Guide Bracket Position Screw Nut, for 225841

No.	Plate	Name
201533E	11598	Corder Arm Adjusting Screw Nut, for 225684
201554D	10360	Ruffler Driving Lever Spring Adjusting Nut, for 225857
201557B	10350	Hemmer Base Plate Screw Stud Nut, for 225793
201562B	---	Tuck Folder Space Gauge Stop Screw Stud Thumb Nut, for 225927
201563B	10335	Hemmer Swing Bracket Base Screw Stud Thumb Nut, for 226977
201564B	11598	Tuck Folder Screw Stud Thumb Nut, for 225927
201566B	13357	Cord Guide and Strip Folder Thumb Nut, for 220749 and 220833
201572B	10881	Bobbin Winder Tension Stud Thumb Nut, for 225462
201572B	10881	Tension Thumb Nut, for 202409
201583C	10360	Ruffling Blade Lever Adjusting Thumb Screw Wing Nut, for 225857
*201609	---	Hemmer Shank Switch Handle Stud, for 225765
201813	13378	Tuck Marker Shaft Driving Crank Roller 201829 with 200274E, for 225945
201829	10381	Tuck Marker Shaft Driving Crank Roller, for 201813
201856	11600	Ruffler Needle Bar Collar Roller, for 225850
202005	10245	Arm Screw Washer
*202056	---	Bobbin Case Latch Pin, for 202333
202068	12153	Spool Holder Base, for 204297
202090	13356	Presser Foot Hinge Pin, for 202351, 202371, 202372, 202323, 229863 to 229865, 229867 and 229868
202091	10252	Thread Retainer Sleeve, for 204059
202092	10252	" " Spring, for 204059
202115	13379	Tuck Marker Tuck Greaser Plate Spring, for 225797
202135	10245	Face Plate Position Pin
202243	13351	Arm Shaft Bushing (back) with 202244
202244	---	Arm Shaft Bushing Oil Packing (wick), for 202243 and 207080
202247	10667	Arm Cap
202248	10244	" " Screw Washer
202249	13351	" Shaft with 200357E and 202400, for Machines Nos. 61W53, 61W72 and 61W81

No.	Plate	Name
202250	13365	Arm Shaft with 200357E and 202400, for Machine No. 61W154
202252	10244	Arm Shaft Connection Belt Pulley with 200327C, 200302E and two 202253, for 203134
202253	10244	Arm Shaft Connection Belt Pulley Spring Flange, for 202252
202254	---	Needle Bar Connecting Link Stud Oil Packing (wick), for 202333
202255	13351	Balance Wheel (belt groove 2 1/2 in. diam.) with 200328E and 200335C
202260	---	Hook Shaft Oil Packing (wick)
202265	11671	Bobbin
202267	11671	" Case Latch, for 202533
202269	11671	" " Plunger, for 202533
202270	11671	" " Spring, for 202533
202271	10667	Face Plate
202275	10667	Feed Bar, for 203122 and 206860
202276	10245	" " Slide Block, for 203124
202277	---	Bobbin Winder Frame Oil Packing (wick), for 225453
202277	---	Feed Driving Connection Oil Packing (wick), for 202297
202277	---	Feed Lifting Connection Oil Packing (wick), for 202296
202277	---	Take-up Lever Driving Stud Oil Packing (wick), for 202399
202278	10913	Feed Dog, for binding, for 202811
202281	10913	" " " 202815
202282	10913	" " " general muslin work, for 202818, 202951, 203073, 203113 and 203124
202283	10913	Feed Dog, for handkerchief hemming, knit goods and shoe lining, for 202819
202284	10913	Feed Dog, for binding dress shields, for 202812
202287	10913	Feed Dog, for muslin work and gathering, for 202822
202289	10913	Feed Dog, for 202817
202290	10912	" " " special work, for 202824
202293	10912	Feed Dog, 21 teeth (27 teeth to the inch), for 202827 and 244041
202294	10912	Feed Dog, for tucking, for 202828, 202830 and 244032
202295	10912	Feed Dog, for tucking, for 202829
202296	10912	" " " " 202831
202297	10667	" Driving Connection with 200054E and 202277

No.	Plate	Name
202298	10245	Feed Bar Slide Block Crank with 200038c, for 203124
202298	10245	Feed Driving Connection Crank with 200038c
202300	10246	Feed Driving Eccentric Regulating Bracket, for 203124
202301	10246	Feed Driving Eccentric Regulating Bracket Plunger
202302	10248	Knee Lifter Connection Lever Lifting Rod Cotter Pin, for 20241
202303	13377	Feed Driving Rock Shaft, for 202860
202304	13365	" " " " " " " " 204122
202305	10245	" " " " " " " " " " "
202305	10245	" Lifting Rock Shaft Centre
202306	10667	" " Connection with 200541 and 202277
202307	10246	Feed Lifting Connection Eccentric with 200382c and 200437c
202308	13377	Feed Lifting Rock Shaft, for Machines Nos. 61w52, 61w72 and 61w84
202310	13376	Feed Regulating Spindle with 202311, 202443 and 202619
*202311		Feed Regulating Spindle Head for 202310
*202319		Hook Shaft, 13 1/2 in. long, for 21022
*202320		" " " " " " " " " " " " " " 11 1/2 in. long, for 21041
202321	10245	" " Bushing (back)
202322	10245	" " " " " " (front)
202323	10244	" " Connection Belt Pulley with 202324 and two 201018c
202324	10244	Hook Shaft Connection Belt Pulley Spring Flange, for 202323
202326	10248	Needle Bar with 200441, for 20423
202327	10248	" " Bushing, for 203123
202328	13376	" " Crank with 20025c, 200428c, 202323 and two 20034c, for 203117
202329	10248	Needle Bar Connecting Stud 200891 with 200086c and 202330, for 203117
202330		Needle Bar Connecting Stud Oil Packing (wick), for 202329
202331	10248	Needle Bar Connecting Link, for 203117
202333	10248	Needle Bar Connecting Link Stud with 202254, for 202328
202335	10667	Presser Bar 241033 with 200074, for 206398

No.	Plate	Name
202337	13375	Presser Bar Position Guide
202338	13375	" " " " " " Lever with 200086c
202339	13375	Presser Bar Lifter
202343	13378	" " Spring (light)
202346	13378	" " " " Stop Rod
202351	10927	Presser Foot (hinged) complete, 46 needle hole, Nos. 202090, 202924 and 229055, for knit goods, for Machines Nos. 61w52 and 61w84
202354	10926	Presser Foot, for 3/16 and 3/8 in. stitching margins, for collar and cuff work, for Machines Nos. 61w52 and 61w84
202355	13378	Presser Bar Thumb Screw Thumb Set Screw Packing (brass)
202356	10263	Presser Foot, for Lending, for Machines Nos. 61w52 and 61w84
202361	10926	Presser Foot, for Lending, for Machines Nos. 61w52 and 61w84
202366	10926	Presser Foot, for stitching margins from 3/8 to 3/4 in. in steps of 1/8 in., with 200175c and 202810, for Machines Nos. 61w52 and 61w84
202368	10259	Presser Foot (deep grooved) (grooved to left of needle hole), from 4 to 16 cords to the in., as ordered, for top cording, for Machines Nos. 61w52 and 61w84
202369	10259	Presser Foot (deep grooved) (grooved to left of needle hole), from 4 to 16 cords to the in., as ordered, for top cording, for Machine No. 61w84
202370	10259	Presser Foot (deep grooved) (grooved to right of needle hole), from 4 to 16 cords to the in., as ordered, for top cording, for Machines Nos. 61w52 and 61w84
202371	13356	Presser Foot (hinged) complete, Nos. 202090, 202924 and 203035, for umbrella hemming, for Machines Nos. 61w52 and 61w84
202372	13356	Presser Foot (hinged) complete, Nos. 202090, 202924 and 203034, for handkerchief hemming, for Machines Nos. 61w52 and 61w84
202373	13355	Presser Foot, for gathering, for Machines Nos. 61w52 and 61w84

No.	Plate	Name
202375	10926	Presser Foot for mattress binding, for Machines Nos. 61w52 and 61w81
202376	10926	Presser Foot for mattress binding, for Machines Nos. 61w52 and 61w81
202390	10263	Presser Foot, for front steel stitching in corset work, for Machines Nos. 61w52 and 61w81
202397	13378	Take-up (auxiliary)
		Nos. 202398 to 202400, for 203117
202398	10247	Take-up Lever
202399	10247	" " Driving Stud with 202277
202400	10247	Take-up Lever Hinge Stud with 202423
202401	10247	Take-up Lever Oiling Pin
202404	10247	Tension Release Plunger
202405	10247	" " Washer, for 202409
202407	10881	Bobbin Winder Tension Spring, for 225462
202407	10881	Tension Spring, for 202409
202409	10252	Tension complete, Nos. 2006251, 201572a, 202405, 202407, 202410, 244097 and 244008
202410	10252	Thread Control Spring, for 202409
202411	10252	" " " Stop
202413	10252	" Guide
202414	10252	" "
202415	10252	" "
202417	10252	" "
202418	10929	Presser Foot
202423	----	Take-up Lever Hinge Stud Oil Packing (twice), for 202400
202443	10244	Feed Regulating Spindle Head Pin, for 202310
202447	13376	Knee Lifter Connection Lever Lifting Rod with 202302, for 244025 and 244037
*202456	----	Knee Lifter Rock Lever Rod Cap or Oil Guard, for 202730
202473	10885	Bobbin Winder Pulley with 200380c, for 225382
202478	10884	Bobbin Winder Stop Latch Trip Lever, for 225382
202500	13378	Bobbin Case Lever, for 244021
202501	13378	" " Bushing, for 244021

No.	Plate	Name
202529	10926	Presser Foot (split), for gathering
202530	13351	Arm Shaft Connection Bell
202533	11671	Bobbin Case complete, Nos. 200591c, 200584c, 202056, 202267, 202269, 202270, 202716 and 202806, for 24432
202534	10390	Throat Plate Bobbin Case Stop, for 202311, 202812, 202815 to 202819, 202822, 202824, 202827 to 202831, 202951, 202969, 203053, 203056, 203063, 203073, 203111, 203113, 203075, 207076, 225622, 226000, 226049 and 230823
202572	13356	Presser Foot Hinge Pin, for 231238
202595	10246	Feed Driving Eccentric Regulating Bracket Plunger Spring
202600	11598	Feed Folder Screw Stud Thumb Nut Washer, for 225927
202602	10246	Feed Folder Space Gauge Stop Screw Stud Thumb Nut Washer, for 225927
202603	10246	Hexamer Shank Screw Washer, for 225778 and 225781
202619	13375	Throat Plate Bobbin Case Stop Position Pin, for 202812, 202815 to 202819, 202822, 202824, 202827 to 202831, 202951, 202969, 203053, 203056, 203063, 203073, 203111, 203113, 203075, 207076, 225622 and 226000
202619	13375	Feed Regulating Spindle Head Position Pin, for 202310
202651	13365	Feed Lifting Rock Shaft, for Machine No. 61w154
202716	11671	Bobbin Case Tension Spring, for 202533
202730	11599	Knee Lifter Rock Lever Rod, 8 in. long, with 202456
*202806		Bobbin Case, for 202533
202807	10925	Presser Foot Spring Guide, for 229871
202809	10927	Presser Foot Adjustable Spring Guide, for 206799
202810	10926	Presser Foot Spring Guide, for 202366
202811	13354	Throat Plate, 50 needle hole, for needle sizes 11 and 15, with 202534, 244026 and two 2005820, for binding corsets and similar work, for 202278

Numerical List of Parts

No.	Plate	Name
202812	10390	Throat Plate, 46 needle hole, for needle sizes 16 and 18, with 202534, 202619 and two 200583u, for 202281
202815	10391	Throat Plate, 53 needle hole, for needle sizes 12 and 13, with 202534, 202619 and two 200583u, for tucking work, for 202281
202816	10391	Throat Plate, 50 needle hole, for needle sizes 14 and 15, with 202534, 202619 and two 200583u, for top cording for 203136
202817	10391	Throat Plate, 60 needle hole, for needle size 8 and 9, with 202534, 202619 and two 200583u, for fine shirt work, for 202289, 207053 and 207054
202818	13354	Throat Plate, 50 needle hole, for needle sizes 11 and 15, with 202534, 202619 and two 200583u, for 202282, 207055 and 207056
202819	10391	Throat Plate, 50 needle hole, for needle size 11 and 15, with 202534, 202619 and two 200583u for 202283, 207051 and 207052
202822	10391	Throat Plate, 50 needle hole, for needle sizes 14 and 15, with 202534, 202619 and two 200583u, for muslin work and gathering, for 202287
202824	10390	Throat Plate, 50 needle hole, for needle sizes 14 and 15, with 202534, 202619 and two 200583u, for special work, for 202290
202827	10390	Throat Plate, 53 needle hole, for needle sizes 12 and 13, with 202534, 202619 and two 200583u, for 202293 and 241941
202828	13354	Throat Plate, 53 needle hole, for needle sizes 12 and 13, with 202534, 202619 and two 200583u, for tucking with Tuck Folder, for 202294
202829	10390	Throat Plate, 50 needle hole, for needle sizes 12 and 13, with 202534, 202619 and two 200583u, for special tucking, for 202295

Numerical List of Parts

No.	Plate	Name
202830	13380	Throat Plate, 53 needle hole, for needle sizes 12 and 13, with 202534, 202619 and two 200583u, for 202294 and 241932
202831	10391	Throat Plate, 50 needle hole, for needle sizes 14 and 15, with 202534, 202619 and two 200583u, for 202296
202924		Presser Foot Shank, for 202351, 202371, 202372, 203323, 229863 to 229865, 229867, 229868 and 231238
202951	13357	Throat Plate, 56 needle hole, for needle sizes 10 and 11, with 202534, 202619 and two 200583u, for 202292, 207055 and 207056
202969	10917	Throat Plate, 50 needle hole, for needle sizes 11 and 15, with 202534, 202619 and two 200583u, for fine shirt work, for 202970
202970	10912	Feed Dog, for general muslin work, for 202969
203009		Presser Foot Plate, for 229864
203010		" " " " 229863
203011		" " " " 229867
203012		" " " " 229868
203024		" " " " 229865
203034		" " " " 203372
203035		" " " " 203371
203037		" " " " with 231235 to 231237 and six 200175u, for 231238
203052	10917	Throat Plate, 53 needle hole, for needle sizes 12 and 13, with 202534, 202619 and two 200583u, for 203072
203056	10917	Throat Plate, 50 needle hole, for needle sizes 14 and 15, with 202534, 202619 and two 200583u, for tucking, for 203071
203063	10917	Throat Plate, 50 needle hole, for needle sizes 14 and 15, with 202534, 202619 and two 200583u, for special work, for 203083
203071	10912	Feed Dog for 203056 and 206975
203072	10912	" " " 203053
203073	10917	Throat Plate, 46 needle hole, for needle sizes 16 and 18, with 202534, 202619 and two 200583u, for 202282, 207055 and 207056
203075	10935	Heelmer Base Plate with 225706, for 230000

No.	Plate	Name
203083	10912	Feed Dog, for 203063
203100	---	Arm Shaft Oil Packing (wick), for 202249 and 202259
203101	---	Hook Oil Wick, for 244944 and 244923
203111	13357	Throat Plate, 50 needle hole, for needle sizes 14 and 15, with 202534, 202619 and two 200583a, for regular cloth work, for 203417
203113	13357	Throat Plate, 40 needle hole, for needle sizes 20 and 22, with 202534, 202619 and two 200583a, for general muslin work, for 202282, 202955 and 207056
203117	---	Needle Bar Crank 202328 with 202329, 202331 and 202398 to 202400
203121	---	Feed Driving Rock Shaft 206860 with 202292 and two 200406c, for Machines Nos. 61w52, 61w72 and 61w84
203122	---	Feed Driving Rock Shaft 203304 with 200646c, 204527c and 202275, for Machine No. 61w154
203123	---	Needle Bar Bushing 202327 with 202326
203124	---	Feed Bar Slide Block Crank 202298 with 200205c, 204548c and 202276
203134	---	Feed Driving Regulating Bracket 202300 with 202252, two each 204044c and 204254c
203136	13354	Feed Dog, for 202846
203172	10248	Needle Bar Crank Friction Washer
203173	13354	Feed Dog, for 226000
203177	13380	Presser Foot, for 244032
203179	10926	" " " $\frac{1}{8}$ in. stitching margin, for collar and cuff work, for Machines Nos. 61w52 and 61w84
203187	13380	Presser Foot, for tack marking or creasing, for 244032
Nos. 203198 to 203200, for 225979 and 244044		
203198	13355	Presser Foot, for laying tucks
203199	13355	" " " " narrow tucks
203200	13255	" " " " tucks toward the needle
203322	---	Presser Foot Plate, for 203323

No.	Plate	Name
203323	13356	Presser Foot (hinged) complete, 50 needle hole, Nos. 202090, 202924 and 203322
203417	13354	Feed Dog, for 203111
204004	14600	Hammer Shank Switch Handle Washer, for 225769
204058	10252	Thread Retainer Stud, for 204059
204059	---	Thread Retainer complete, Nos. 202091, 202092 and 204058
204225	14174	Knee Lifter Rock Shaft Lifting Lever Rod Swivel Spring, for 228233
204225	13375	Arm Position Pin
204296	12153	Spool Holder Wire, for 204297
204297	12153	Spool Holder complete, Nos. 2000730, 202068 and 204296
204925	13378	Tension Stud Washer, for 200625r
206482	14598	Presser Foot Bracket Row Screw Washer, for 225699, 225930 and 225940
206528	10925	Presser Foot, for stitching margins $\frac{1}{8}$, $\frac{1}{4}$ and $\frac{3}{8}$ in., for Machines Nos. 61w52 and 61w84
206608	13375	Presser Bar Lifting Releasing Lever Bracket Spring
206728	13363	Bobbin Case Lever Driving Eccentric Connection with 244009, for 244020
206730	13363	Bobbin Case Lever Driving Eccentric Connection Lever with 200086c, for 244021
206731	13363	Bobbin Case Latch Fulcrum Pin, for 206736
206733	13378	Bobbin Case Cap with 200592c, 204046c and 206738, for 206734
206734	13363	Bobbin Case Cap complete, Nos. 200964c, 206733, 206736 and 240736, for 207058
206735	13363	Bobbin Case Latch, for 206736
206736	---	" " " " 206735 with 206731 and 206737, for 206734
206737	13363	Bobbin Case Latch Lever, for 206736
206728	13363	" " " " Tension Spring, for 206733
206758	---	Bobbin Case Lever Driving Eccentric Connection Lever Oil Wick, for 244020
206761	13363	Bobbin Case Lever Driving Eccentric Washer, for 244019

No.	Plate	Name
206775	11671	Hook Shaft Pin, for 244011 and 244023
206785	10929	Presser Foot
206786	10929	" " (split), for Machines Nos. 61w52 and 61w84
206787	13353	Presser Foot, for stitching margins from $\frac{1}{2}$ to $\frac{1}{4}$ in. in steps of $\frac{1}{8}$ in., for Machines Nos. 61w52 and 61w84
206788	10929	Presser Foot, for Machines Nos. 61w52 and 61w84
206790	10927	Presser Foot, for stitching margins $\frac{1}{2}$ to $\frac{1}{4}$ in. in steps of $\frac{1}{8}$ in., with 200904r and 202809, for Machines Nos. 61w52 and 61w84
206791	10925	Presser Foot, for use with English Binder, for Machines Nos. 61w52 and 61w84
206792	10925	Presser Foot, for stitching margins from $\frac{1}{2}$ to $\frac{1}{4}$ in. in steps of $\frac{1}{8}$ in., for Machines Nos. 61w52 and 61w84
206794	10929	Presser Foot, for tailoring work, for Machines Nos. 61w52 and 61w84
206840	11598	Tuck Folder Screw Stud Adjusting Screw Spring Washer, for 225927
206842	13356	Presser Foot Cleft Holder, for Machines Nos. 61w52 and 61w84
206852	13375	Hook Gib, for 244011 and 244023
206860	-	Feed Driving Rock Shaft 202303 with 200641C, 201522c, and 202375, for 203121
*206891	-	Needle Bar Connecting Stud, for 202329
206974	11600	Hemmer Foot, for $\frac{1}{2}$ in. hem, for Machines Nos. 61w52 and 61w72
206975	13357	Throat Plate, 50 needle hole, for needle sizes 14 and 15, with 202534, 202619 and two 200583n, for 207071
206992	13380	Presser Foot, for tuck marking or creasing, for 244022
206998	13356	Presser Foot Holder with 200542a, for Presser Bar 202335 as a substitute for Compound Presser Bar 202544, for 225865
207051	10915	Feed Dog, for handkerchief hemming, knit goods and shoe lining, for 202819

No.	Plate	Name
207052	10915	Feed Dog, for handkerchief hemming, knit goods and shoe lining, for 202819
207053	10915	Feed Dog, for shirt, collar and cuff work, for 202817
207054	10915	Feed Dog, for shirt, collar and cuff work, for 202817
207055	10915	Feed Dog, for general muslin work, for 202818, 202951, 203073 and 203113
207056	10915	Feed Dog, for general muslin work, for 202818, 202951, 203073 and 203113
207057	13363	Bobbin Case Base, for 207058
207058	13363	Bobbin Case complete, Nos. 206734 and 207057, for 244021, 244022 and 244024
207072	13375	Presser Bar Bushing
207075	13380	Feed Dog, for leather work, for 207076
207076	13380	Throat Plate, 50 needle hole, for needle sizes 14 and 15, with 202534, 202619 and two 200583n, for 207075
*207079	-	Arm, for Machines Nos. 61w52, 61w72 and 61w84
207080	13376	Arm Shaft Bushing (front) with 202244
*207081	-	Bed, for Machines Nos. 61w52, 61w72 and 61w84
207082	13376	Bed Plate (back), for Machines Nos. 61w52, 61w84 and 61w154
207083	13376	Bed Slide (front), for Machines Nos. 61w52, 61w72 and 61w84
*207084	-	Arm, for Machine No. 61w154
*207085	-	Bed, for Machine No. 61w154
207086	13376	" Slide (front), for Machine No. 61w154
210736	13363	Bobbin Case Latch Spring, for 206734
213540	13380	Ribbon Reel Center Pin Washer, for 226211
225381	10884	Bobbin Winder Spindle, for 225382
225387	10885	Universal Bobbin Winder complete, Nos. 200056c, 200082b, 200299n, 202473, 202478, 225381, 225433, 225444, 225453 to 225456, 225458, 225462, 228026, two each 225459 and wood screws $\frac{3}{8}$ in., No. 12, R.H.B.

No.	Plate	Name
225433	10885	Bobbin Winder and Tension Bracket Base, for 225382
225438	10884	Bobbin Winder Frame Oil Well Cap, for 225453
225444	10884	Bobbin Winder Stop Latch, for 225382
Nos. 225453 to 225456, for 225382		
225453	10884	Bobbin Winder Frame with 202277 and 225438
225454	10884	Bobbin Winder Frame Hinge Pin
225455	10884	" " Spring
225456	10884	" " Plunger
225458	10884	" " Stop Latch Thumb Lever, for 225382
225459	10884	Bobbin Winder Stop Latch Thumb Lever Hinge Stud
225459	10884	Bobbin Winder Stop Latch Thumb Lever Joint Stud, for 225382
225461	10881	Bobbin Winder Tension Bracket with 201499a, for 225462
225462	10881	Bobbin Winder Tension Bracket complete, Nos. 201572a, 202407, 225461 and two 2102, for 225382
*225482		Bobbin Case Screw Driver Blade, for 225497
*225483		Bobbin Case Screw Driver Handle, for 225497
*225484		Screw Driver Blade, for 225498
*225485		" " Handle, for 225498
225497	12153	Bobbin Case Screw Driver complete, Nos. 225482 and 225483
225498	12153	Screw Driver complete (7 1/2 in. long), Nos. 225484 and 225485, for Machines Nos. 61w52, 61w84 and 61w154
Nos. 225502 to 225504, for Machines Nos. 61w52 and 61w84		
225502	10354	Hemmer Foot, for 3/4 in. hem
225503	10354	" " " " lace, for 3/4 in. hem
225504	10354	Hemmer Foot, for 1/2 in. hem
225508	10923	Presser Foot, for gathering, for Machines Nos. 61w52 and 61w84
225554	12153	Wrench (steel), for Machines Nos. 61w52, 61w84 and 61w154
225586	11600	Hemmer Shank Position Pin, for 225767

No.	Plate	Name
225610	1009	Binder Bed, for 225612
225612	1009	" Folder with 225610, for 225623
225613	1009	" " Slide with 200768e, for 225623
225614	1009	Binder Folder Slide Adjusting Thumb Nut Guide, for 226077
225615	1009	Binder Folder Slide Cap, for 225623
225616	1009	Guide (front), for 225623
Nos. 225618 to 225620, for 225623		
225618	1009	Guide (back, lower)
225619	1009	" (back, upper)
225620	1009	Binder Pressure Spring
225621	1010	Presser Foot, for Machines Nos. 61w52 and 61w84
225622	1010	Throat Plate, 53 needle hole, for needle sizes 12 and 13, with 202534, 202619 and two 200582a, for 225977
225623	1010	Binder complete, Nos. 200176a, 225612, 225613, 225615, 225616, 225618 to 225620, 226077, two each 200164a and 200893b, for Machines Nos. 61w52 and 61w84
225624	1098	Binder on Shank, for tapes 3/4, 7/8, 1, 1 1/8, 1 1/4, 1 1/2, 1 3/4, 1 7/8 and 1 in., for Machines Nos. 61w52 and 61w84
225630	1012	Binder on Shank, for tapes from 1/2 to 1 in., in steps of 1/16 inch, for Machines Nos. 61w52 and 61w84
225631	1012	Binder on Shank with Shank extending beyond Binder, for tapes of the following widths: 3/4, 7/8, 1, 1 1/8, 1 1/4, 1 1/2, 1 3/4, 1 7/8 and 1 in., for Machines Nos. 61w52 and 61w84
225633	1012	Binder on Shank, in sizes 1/2 and 3/4 in., for Machines Nos. 61w52 and 61w84
225634	1012	Binder on Shank, for 1/2, 3/4 and 1 in., for Machines Nos. 61w52 and 61w84
225646	10316	Binder on Shank, for tapes from 1/2 to 1 in., in steps of 1/16 in., for Machines Nos. 61w52 and 61w84
225659	10316	Bias Binder on Shank, for binding from 3/4 to 1 in., in steps of 1/16 in., for Machines Nos. 61w52 and 61w84
225663	321	Ribbon Reel (9 in. diam.) with 225666, for 225976

No.	Plate	Name
225664	11598	Ribbon Reel Supporting Spindle for 225665
225665	---	Ribbon Reel Supporting Spindle Base with 225664 and two wood screws $\frac{3}{4}$ in., No. 7, for 225976 and 226291
225666	---	Ribbon Reel Supporting Spindle Hub 230471 with 225980, for 225663 and 226290
225684	10322	Corder Arm with 200340c, 201523b and three 225686, for 225688
225685	10322	Corder Arm Bracket with 200851b, for 225688
225686	10322	Corder Arm Cord Guide, for 225684
225687	10322	" " Bracket Hinge Pin, for 225688
225688	11599	Corder Arm and Bracket complete, Nos. 225684, 225685, 225687, 225689 and two 200035a, for Machines Nos. 61w52 and 61w84
225689	10322	Corder Arm Bracket Screw Clamp Washer, for 225688
225690	10923	Presser Foot, from 4 to 16 cords to the in., as ordered, for top and bottom cording, for Machines Nos. 61w52 and 61w84
225693	10325	Presser Foot and Bracket, for 225699, 225930 and 225940
225695	---	Presser Foot Bracket Bow, 8 in. long, with 225698 and 231149, for 225699
225696	10325	Presser Foot Bracket Bow, 6 in. long, with 225698 and 231149, for 225930
225697	---	Presser Foot Bracket Bow, 4 in. long, with 225698 and 231149, for 225940
225698	10325	Presser Foot Bracket Bow Cord Tube, for 225695, 225696 and 225697
225699	10325	Corder, 8 in. bow, complete, Nos. 225693, 225695, two each 200185a and 206482, for Machines Nos. 61w52 and 61w84
225702	13356	Presser Foot, for Welts, for Machines Nos. 61w52 and 61w84
225706	---	Hemmer Base Plate Position Pin, for 203075

No.	Plate	Name
225707	13379	Tuck Marker Tuck Creaser Plate 225932 with 202115, 225931, 225933, 225934, two each 200142a and 200172a, for 241031
225708	10344	Hemmer Base Plate Spring, for 230000
225723	10926	Presser Foot, for Machine No. 61w84
225729	11598	Folder, turn the upper edge under and the under edge over, for M, H, XH, XXH or XXXH Material, for Machines Nos. 61w52 and 61w84
225734	10335	Hemmer Swing Bracket Base Screw Stud Washer, for 226977
225735	10335	Hemmer Swing Bracket Base, for 226977
225749	10393	Hemmer Foot, for $\frac{1}{2}$ in. hem, for Machines Nos. 61w52 and 61w84
225764	---	Hemmer on Shank, for 225769
225765	10344	" Shank Switch Handle with 200397c and 201609, for 225769
225767	---	Hemmer Plate with 200857a and 225586, for 225769
225769	10324	Hemmer complete, for hems $\frac{1}{2}$ to 1 in., Nos. 201904, 225764, 225765, 225767 and 230000
225776	10346	Hemmer, for $\frac{3}{4}$ in. hem, for 225778
225777	10346	" Shank, for 225778
225778	10346	Hemmer complete, Nos. 200142a, 202603, 225776 and 225777
225779	10347	Hemmer on Shank, for $\frac{5}{8}$ in. hem, for 225781
225780	10347	Hemmer Lace Guide, for 225781
225781	10347	Hemmer (reverse) complete, Nos. 225779, 225780, two each 200142a and 202603
225787	11599	Hemmer on Shank, for 230865
		Nos. 225790 to 225792, for 225793
225799	10350	Hemmer on Shank
225791	10350	" Base Plate with 200838a
225792	10350	Presser Foot
225793	10350	Hemmer complete, for hems $\frac{1}{2}$ to 1 in., Nos. 201557a and 225799 to 225792
225794	---	Hemmer on Shank, for 225796
225796	10324	Hemmer complete, for hems $\frac{1}{2}$ to $\frac{3}{4}$ in., Nos. 225794 and 230000

No.	Plate	Name
225798	10353	Presser Foot, for Machines Nos. 61w52 and 61w84
Nos. 225800 to 225817, for Machines Nos. 61w52 and 61w84		
225800	10354	Hemmer Foot, for lace, for $\frac{1}{8}$ in. hem
225801	10393	Hemmer Foot, for $\frac{1}{4}$ in. hem, for thick soft woolsens and felling corset seams
225802	10393	Hemmer Foot, for $\frac{3}{8}$ and $\frac{1}{2}$ in. hem, for cord guiding, sews a cord within the hem
225803	10353	Hemmer on Shank, for hems of the following widths: $\frac{1}{8}$, $\frac{1}{4}$, $\frac{3}{8}$, $\frac{1}{2}$, $\frac{5}{8}$ and $\frac{3}{4}$ inch
225804	10353	Hemmer on Shank, for hems of the following widths: $\frac{1}{8}$, $\frac{1}{4}$, $\frac{3}{8}$, $\frac{1}{2}$, $\frac{5}{8}$, $\frac{3}{4}$ and 1 inch
225805	10354	Hemmer Foot, for lace, for $\frac{1}{4}$ in. hem
225806	10354	Hemmer Foot, for $\frac{3}{8}$ in. hem
225807	10355	" " for $\frac{1}{2}$ in. hem
225808	10355	" " $\frac{3}{4}$ in. hem, for felling
225809	10355	" " $\frac{1}{2}$ in. hem
225810	10355	" " $\frac{3}{8}$ in. hem
225811	10355	" " $\frac{1}{4}$ in. hem
225812	10355	" " $\frac{3}{8}$ in. hem, for "L" shaped Feed Dog 202283 only ..
225813	10355	Hemmer, for $\frac{1}{2}$ in. hem (Troy, long)
225814	10355	" " $\frac{3}{4}$ in. hem (Troy short)
225815	10355	" " $\frac{1}{4}$ in. hem
225816	10355	" " $\frac{1}{2}$ in. hem
225817	10355	" " $\frac{3}{8}$ in. hem
Nos. 225827 to 225829, for 225842		
225827	10357	Plaiter Base Plate
225828	10357	" " " " Arm Bracket with two 200383c
225829	10358	Plaiter Base Plate Arm Shaft
225830	10358	" " Folder Guide, for 225919
225831	10358	" " Bracket, for 225919
225833	10358	" " " " Stop Spring, for 225919
225835	10358	Plaiter Guide, for 225842
225836	10358	" " Adjustable Stop, for 225842

No.	Plate	Name
225839	10358	Plaiter Space Guide, for 225841 ..
225840	10358	" " " " Bracket, for 225841
225841		Plaiter Space Guide complete, Nos. 200417a, 200462b, 201531c, 225839, 225840 and two 200110c, for 225842
225842	10321	Plaiter complete, Nos. 200169c, 200651c, 200845c, 225827 to 225829, 225835, 225836, 225841, 225909, 225919, 226163, two 226164 and three 200579c, for 225919
Nos. 225843 to 225845, for 225857		
225843	10360	Ruffler Driving Lever
225844	10360	" " " " Spring
225845	10360	" " Frame with 225959
225846	10361	" " Guide (left) with 225856 and two 200178b, for Machines Nos. 61w52 and 61w84
225847	10361	Ruffler Guide (right) with 225856 and two 200178b, for Machines Nos. 61w52 and 61w84
225848	10360	Ruffler Needle Bar Collar (for driving 225843), for 225859
225849	10360	Ruffler Needle Bar Collar complete, Nos. 200615c, 201856 and 225848, for 225857
225851	10360	Ruffler Ruffling Blade, for 225857 ..
225852	10360	" " " " Clamp, for 225853
225853	10360	Ruffler Ruffling Blade Lever with 225852, 225854 and two 200175b, for 225857
225854	10360	Ruffler Ruffling Blade Lever Adjusting Thumb Screw Bushing, for 225853
225855	10360	Ruffler Ruffling Blade Switching Lever, for 225857
225856	10361	Ruffler Ruffling Separating Blade, for 225846 and 225847
225857	10361	Ruffler complete, Nos. 200126b, 200255c, 200310c, 200465c, 201554c, 201583c, 225843 to 225845, 225850, 225851, 225853 and 225855, for Machines Nos. 61w52 and 61w84 ..
225862	10356	Presser Foot, for stitching margins from $\frac{1}{8}$ to $\frac{1}{4}$ in., in steps of $\frac{1}{16}$ in., for collar and cuff work, for Machines Nos. 61w52 and 61w84 ..

Numerical List of Parts

No.	Plate	Name
225865	10355	Presser Foot Cleft Holder, for use with 206998, for interchangeable Pressers and Hammers, for Machines Nos. 61w52 and 61w84 ..
225896	13379	Tuck Marker Shaft Driving Crank Cap, for 225939 ..
225909	10358	Plaiter Folder Bracket Guide Stop with 200382c, for 225842 ..
225919	"	Plaiter Folder Bracket 225831 with 225839, 225833, two each 200110c and 200137c, for 225842 ..
225923	10321	Tuck Folder, for 225927 ..
225924	10321	" " ARM, for 225927 ..
225926	10321	" " Space Gauge, for 225927 ..
225927	10321	Tuck Folder complete, Nos. 200090c, 200318a, 200836c, 200843c, 201562c, 201564c, 202600, 202603, 206340, 225923, 225924 and 225926, for Machines Nos. 61w52 and 61w84 ..
225930	10325	Corder, 6 in. low, complete, Nos. 225693, 225696, two each 200134c and 206482, for Machines Nos. 61w52 and 61w84 ..
		Nos. 225931 to 225934, for 225707 ..
225931	10381	Tuck Marker Tuck Creaser ..
225932	"	" " " " Plate ..
225933	10381	" " " " " Slide ..
225934	10381	" " " " " Spring ..
		Nos. 225935 to 225937, for 244031 ..
225935	10381	Tuck Marker ..
225936	13379	" " Shaft with 200175d ..
225937	13379	" " Bracket with two 200579e ..
225939	13379	Tuck Marker Shaft Driving Crank complete, Nos. 200047c, 225896 and 225945, for 244031 ..
225940	10325	Corder, 4 in. low, complete, Nos. 225693, 225697, two each 200183a and 206482 ..
225941	13379	Tuck Marker Shaft Rock Lever, for 225997 ..
225942	10381	Tuck Marker Shaft Rock Lever Pinch Screw Handle with 200852c, for 225997 ..

Numerical List of Parts

No.	Plate	Name
225943	10381	Tuck Marker Shaft Stop Collar with 200481a, for 244031 ..
225945	"	Tuck Marker Shaft Driving Crank with 201813, for 225939 ..
225949	13356	Presser Foot, for Welts, for Machines Nos. 61w52 and 61w84 ..
225959	10360	Ruffler Ruffing Blade Switching Lever Stop Pin, for 225842 ..
225962	10511	Folder on Shank, folds the top goods under and the under goods over and guides a piece of goods between them from the left, for Machines Nos. 61w52 and 61w84 ..
225970	11600	Hemmer on Shank, made for hems of the following widths: 1, 3/4, 1, 1 1/4, 1 1/2, 1 3/4, and 2 in., for 225973 ..
225973	"	Hemmer on Swing Bracket complete, Nos. 225970 and 226977, for Machines Nos. 61w52 and 61w84 ..
225976	"	Ribbon Reel (9 in. diam.) complete, Nos. 225663 and 225665 ..
225977	10310	Feed Dog, for 225622 ..
225980	"	Ribbon Reel Supporting Spindle Hub Base, for 225666 ..
225997	"	Tuck Marker Shaft Rock Lever 225941 with 225942, for 244031 ..
225998	10309	Folder Slide Adjusting Thumb Nut Sleeve Screw Center, for 226112 ..
226000	13357	Throat Plate, 53 needle hole, for needle sizes 12 and 13, with 202534, 202619 and two 200583a, for top and bottom cording, for 203173 ..
226029	10923	Presser Foot, for darning, for Machines Nos. 61w52 and 61w84 ..
226071	10335	Hemmer Swing Bracket Base Hinge Screw Spring Washer, for 226977 ..
226077	"	Folder Slide Adjusting Thumb Nut Guide with 225614 with 226112, for 225622 ..
226110	11599	Hemmer Swing Bracket with 200369b and 200862c, for 226977 ..
226112	10309	Folder Slide Adjusting Thumb Nut Sleeve with 225998, for 226077 ..
226163	10359	Plaiter Guide Screw Stud Washer, for 225842 ..
226164	10359	Plaiter Folder Bracket Stop Collar with 200113c, for 225842 ..

Numerical List of Parts

No.	Plate	Name
226164	10359	Plaiter Space Guide Bracket Stop Collar with 200413, for 228342
226165	10923	Presser Folder, for folding a 2 in. fold from the left which is to be stitched near the edge, for Machines Nos. 61w52 and 61w84
226200	-	Ribbon Reel (6 in. diam.) with 225666
226201	-	Ribbon Reel (6 in. diam.) complete, Nos. 225665 and 226200
226211	-	Ribbon Reel (holding projection 6 1/2 in. diam.) with 213540 and 226211
226212	11598	Ribbon Reel Center Pin, for 226211
226663	11690	Hemmer Adjusting Screw Washer for Machines Nos. 61w52 and 61w84
226663	11690	Hemmer Plate Clamp Washer, for 230000
226977	-	Hemmer Swing Bracket 226410 with 200457a, 2015261, 201563b, 225734, 225735 and 226074, for 225973
228026	10884	Bobbin Winder Tension Bracket Screw Washer, for 225382
228043	11690	Hemmer Adjusting Thumb Screw Washer, for 230865
228170	-	Drip Pan
228212	-	" " (short) with four 1 in. wire nails, for Machines Nos. 61w52, 61w72 and 61w84
228213	-	Drip Pan (long) with four 1 in. wire nails, for Machine No. 61w154
228238	14171	Knee Lifter Rock Shaft Lifting Lever with 356c, for 228239
228239	-	Knee Lifter Rock Shaft Lifting Lever 228238 with 8073, 204225, 228240 and 228241, for 228242 and 228243
228240	14171	Knee Lifter Rock Shaft Lifting Lever Rod (3 in. long), for 228239
228241	14171	Knee Lifter Rock Shaft Lifting Lever Rod Swivel with 200529c, for 228239
228242	14171	Knee Lifter Rock Shaft complete, Nos. 2763, 2768, 7539, 20092, 228239 and two 2770, for Machines Nos. 61w52, 61w72 and 61w84

Numerical List of Parts

No.	Plate	Name
228243	14107	Knee Lifter Rock Shaft complete, Nos. 2763, 7539, 20092, 228239, 228255, 228563, Form A 1079 and two 2770, for Machine No. 61w154
228255	14107	Knee Lifter Rock Shaft Knee Plate Counterbalance Spring, for 228243
228562	14107	Knee Lifter Rock Shaft Knee Arm, for 228563
228563	-	Knee Lifter Rock Shaft Knee Arm complete, Nos. 1507b, 2766, 2767 and 228562, for 228243
229000	13380	Tape Tension Pin, for 230746
229055	-	Presser Foot Plate, for 202351
229597	10925	Presser Foot, stitching margins from 1/2 to 3/4 in., in steps of 1/16 in., for open bosom shirts, for Machines Nos. 61w52 and 61w84
229843	11600	Hemmer Foot, for 3/8 and 1/2 in. hem, for cord guiding, sews a cord within the hem, for Machine No. 61w84
		No. 229856 to 229858, for Machines Nos. 61w52 and 61w84
229856	10929	Presser Foot
229857	10929	" "
229858	10929	" "
229863	10927	Presser Foot (hinged) complete, Nos. 202090, 202924 and 203010, for overalls and tailoring, for Machines Nos. 61w52 and 61w84
229864	10927	Presser Foot (hinged) complete, Nos. 202090, 202924 and 203009, for Machines Nos. 61w52 and 61w84
229865	10927	Presser Foot (hinged) complete, Nos. 202090, 202924 and 203024, for tailoring, for Machines Nos. 61w52 and 61w84
229867	10927	Presser Foot (hinged) complete, Nos. 202090, 202924 and 203011, for overalls, for Machines Nos. 61w52 and 61w84
229868	10927	Presser Foot (hinged) complete, Nos. 202090, 202924 and 203012, for Machines Nos. 61w52 and 61w84

No.	Plate	Name
229871	10925	Presser Foot (right hand spring guide), stitching margins from $\frac{1}{2}$ to $\frac{1}{4}$ in. in steps of $\frac{1}{16}$ in., with 200175n and 202897. Order margin required. For Machines Nos. 61w52 and 61w81
230000	11599	Hemmer Base Plate 203075 with 200246n, 201525n, 225708, 226663 and two 200160n, for 225769, 225796 and 230865
230471		Ribbon Reel Supporting Spindle Hub
230625	13354	Feed Dog, for 230749, 230751 and 230833
		Nos. 230744 to 230746, for 230751
230744	14650	Cord Guide and Strip Folder
230745	14650	Presser Foot, for cord covering ..
230746	14650	Cord Covering Tape Tension Frame with six 229000
230749	14650	Throat Plate, 50 needle hole, for needle sizes 14 and 15, with 201566n, 202534 and two 200583n, for 230625 and 230751, for Machines Nos. 61w52 and 61w81 ..
230751		Cord Covering Attachment complete, Nos. 23983, 200437n, 230625, 230744 to 230746 and 230749, for Machines Nos. 61w52 and 61w81
230833	13357	Throat Plate, 50 needle hole, for needle sizes 14 and 15, with 201566n, 202534 and two 200583n, used with Cord Covering Attachment, for 230625
230864	11599	Hemmer Plate, for 230865
230865		Hemmer complete, Nos. 200160n, 225787, 228043, 230000 and 230861, for Machines Nos. 61w52 and 61w81
230930	13376	Bed Plate (back), for 244011
231149		Presser Foot Bracket Bow Cord Tube (short), for 225695 to 225697
231168	10355	Hemmer, for $\frac{1}{4}$ in. hem, for Machines Nos. 61w52 and 61w81 ..
		Nos. 231235 to 231237, for 202037
231235		Presser Foot Strip Guide with 200488c
231236		Presser Foot Strip Guide Bar
231237		" " " " " " " " Plate

No.	Plate	Name
231238	12355	Presser Foot (hinged) (adjustable) complete, for strips $\frac{1}{2}$ to $\frac{1}{4}$ in., Nos. 202572, 202924 and 203037, for stitching shoe facings, for Machines Nos. 61w52 and 61w81
231337	13350	Cloth Guide
236073	13375	Needle Bar Connecting Link Oil Guard
237837	13377	Knee Lifter Connection Lever, for 244035 and 244037
244004	13375	Presser Bar Lifting Releasing Lever Bracket
244007	10247	Tension Disc (back), for 202409 ..
244008	10247	" " (front), for 202409 ..
244009		Bobbin Case Lever Driving Eccentric Connection Oil Packing (wick), for 206728
*244010		Hook (sewing), for 244023
244011	13377	Hook 244010 with 200445c, 200596c, 200614c, 202320, 203101, 206775, 206852 and 244014, for 244012 and 244022
244012		Hook and Bobbin Case complete, Nos. 202533 and 244011, for Machines Nos. 61w52 and 61w72 ..
244013	13375	Hook Counter Balance with 200444c, for Machines Nos. 61w52 and 61w72
244014	13375	Hook Washer, for 244011 and 244023
244018	13378	Bobbin Case Lever Driving Eccentric with 200380c and 200444c, for 244019
244019		Bobbin Case Lever Driving Eccentric 244018 with 200583n and 206761, for 244020
244020		Bobbin Case Lever Driving Eccentric Connection 206728 with 201194c, 201524c, 206758 and 244019, for 244021
244021		Bobbin Case Outfit complete, Nos. 200333c, 202500, 202501, 206730, 207058 and 244020, for Machines Nos. 61w81 and 61w154
244022		Hook and Bobbin Case complete, Nos. 207058 and 244011, for Machine No. 61w84
244023	13377	Hook 244010 with 200145c, 200596c, 200614c, 202319, 203101, 206775, 206852 and 244014, for 244024 ..

No.	Plate	Name
244024	-----	Hook and Bobbin Case complete, Nos. 207058 and 244023, for Machine No. 61w154
244026	13380	Throat Plate Bobbin Case Stop Position Pin, for 202811
244027	13379	Tuck Marker Guide, for 244028 ...
244028	-----	" " " 244027 with 200179b and 244029, for 244031 ...
244029	13379	Tuck Marker Guide Tuck Smoothing Spring, for 244028
244030	13379	Tuck Marker Shaft Bracket Base Plate, for 244031
244031	-----	Tuck Marker with 200469a, 225707, 225935 to 225937, 225939, 225997, 244028, 244030 and two 225943, for 244032
244032	-----	Tuck Marker complete, Nos. 202294, 202830, 203177, 203187, 206992 and 244031, for Machine No. 61w72 ...
244033	-----	Presser Bar (hollow), for 202235 ...
244034	13377	Knee Lifter Lifting Lever, for 244035
244035	-----	Knee Lifter Connection Lever 237837 with 202447, 244034 and two 200262a, for Machines Nos. 61w52, 61w72 and 61w81
244036	13377	Knee Lifter Lifting Lever, for 244037
244037	-----	Knee Lifter Connection Lever 237837 with 202447, 244036 and two 200262a, for Machine No. 61w154
244041	-----	Adjustable Bench Tuck Folder complete, Nos. 36388, 36394, 202293, 202827, 203198 to 203200, 230930 and two 402b

**ILLUSTRATIONS OF PARTS
FOR
MACHINES
Nos. 61w52, 61w72, 61w84
and 61w154**

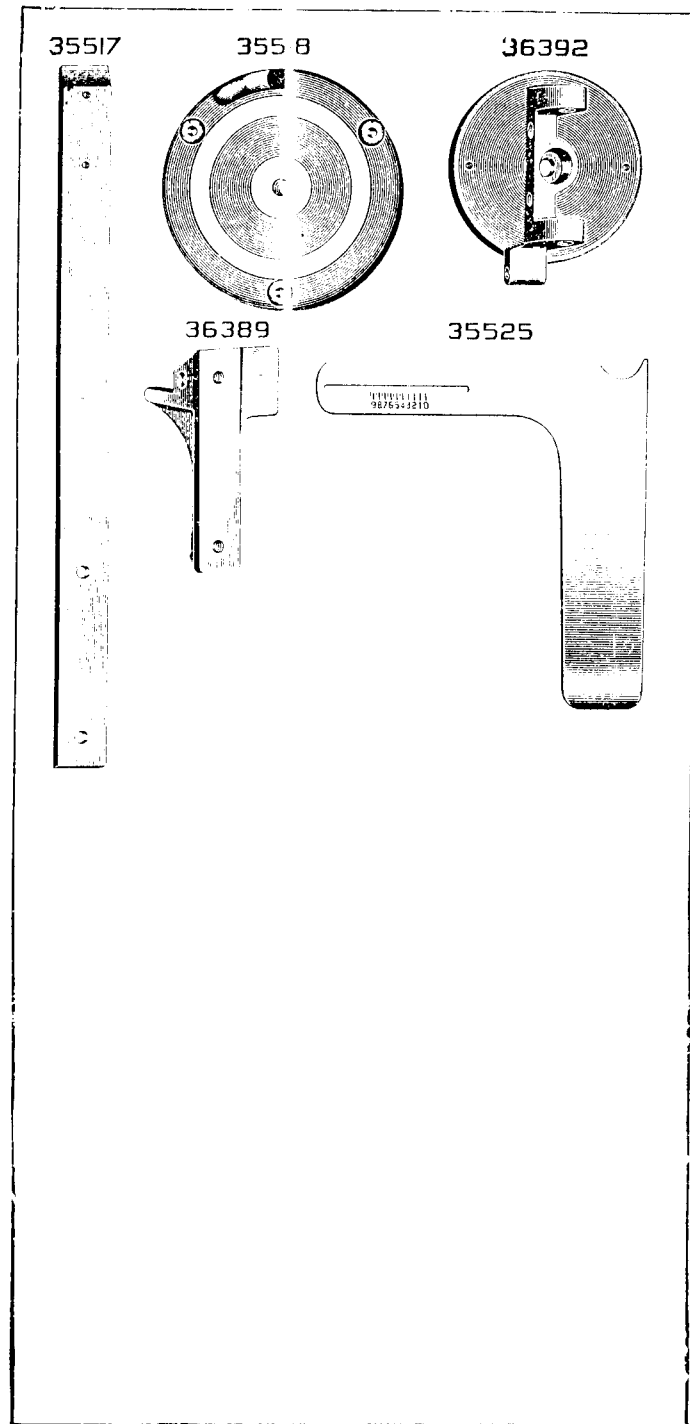


PLATE 5884—ONE-HALF SIZE

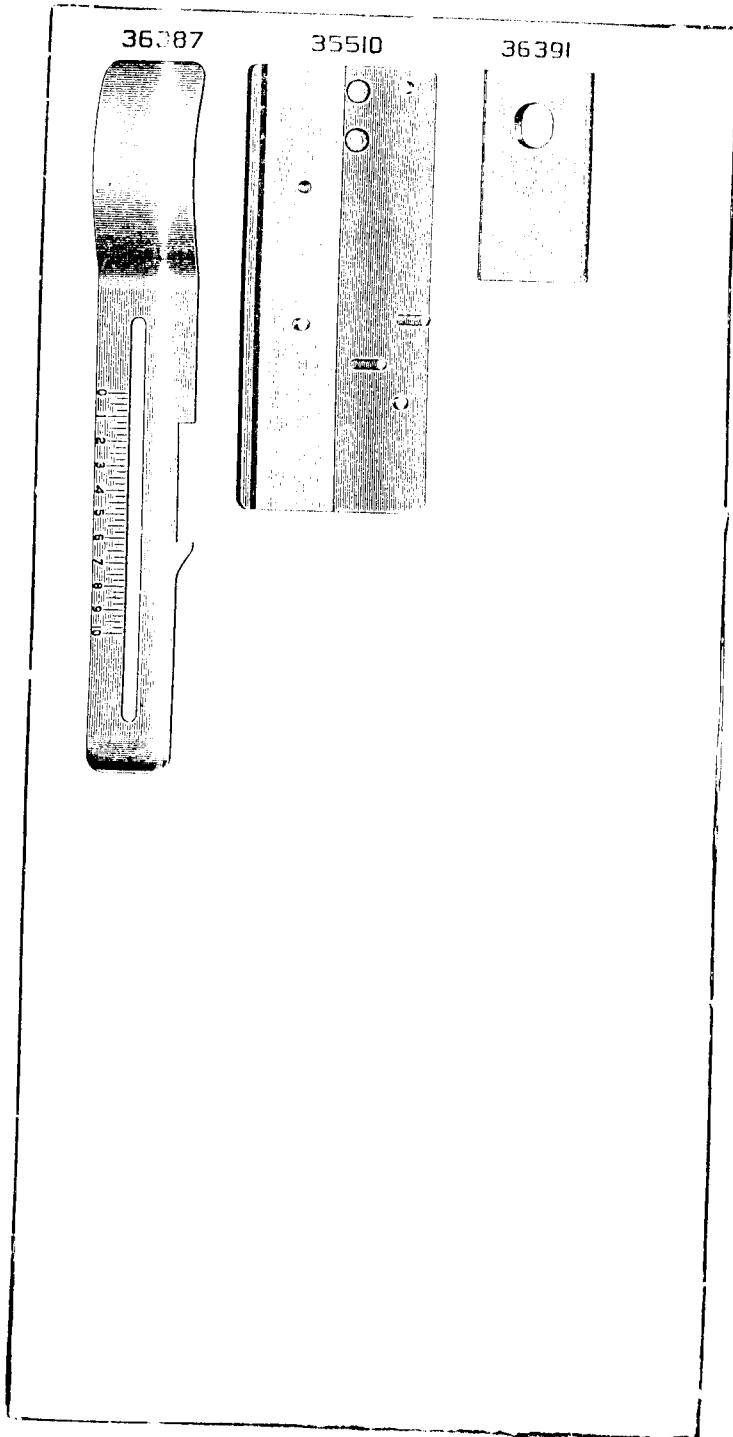


PLATE 5885—FULL SIZE

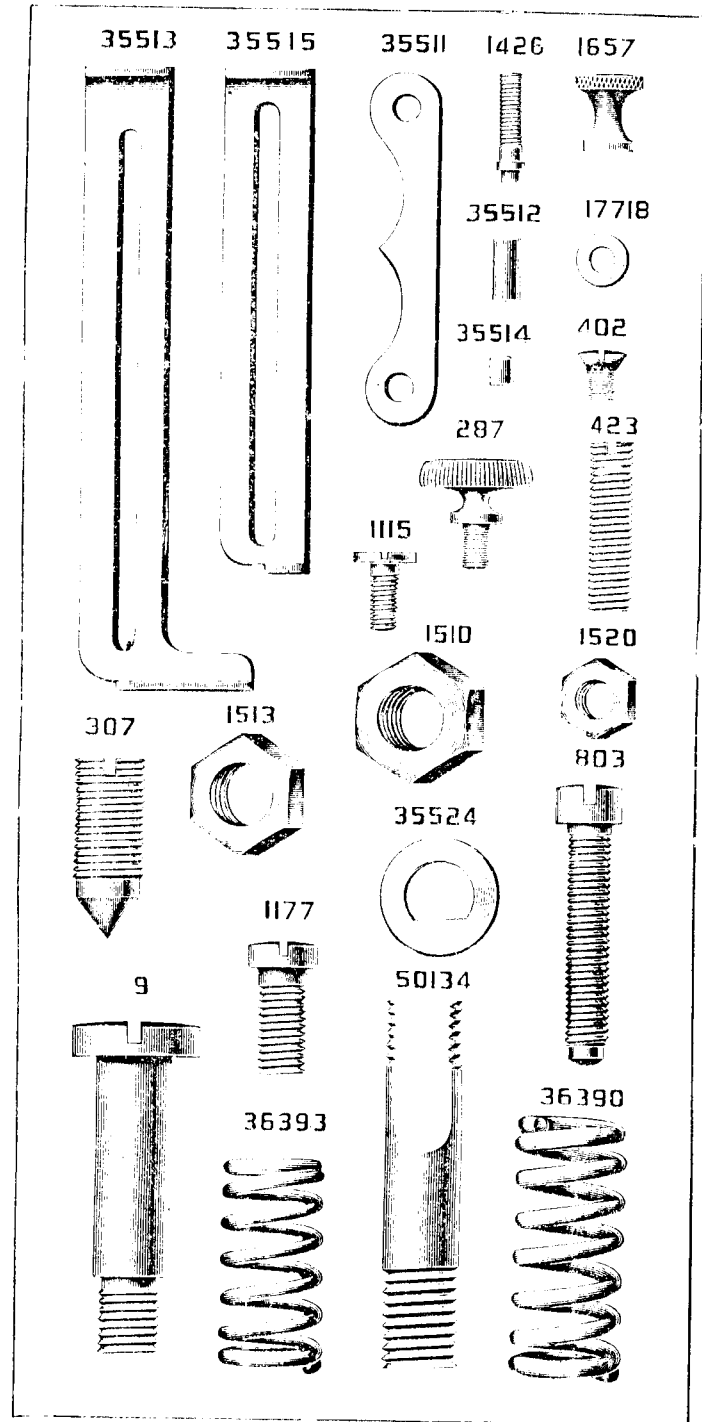


PLATE 10244-FULL SIZE

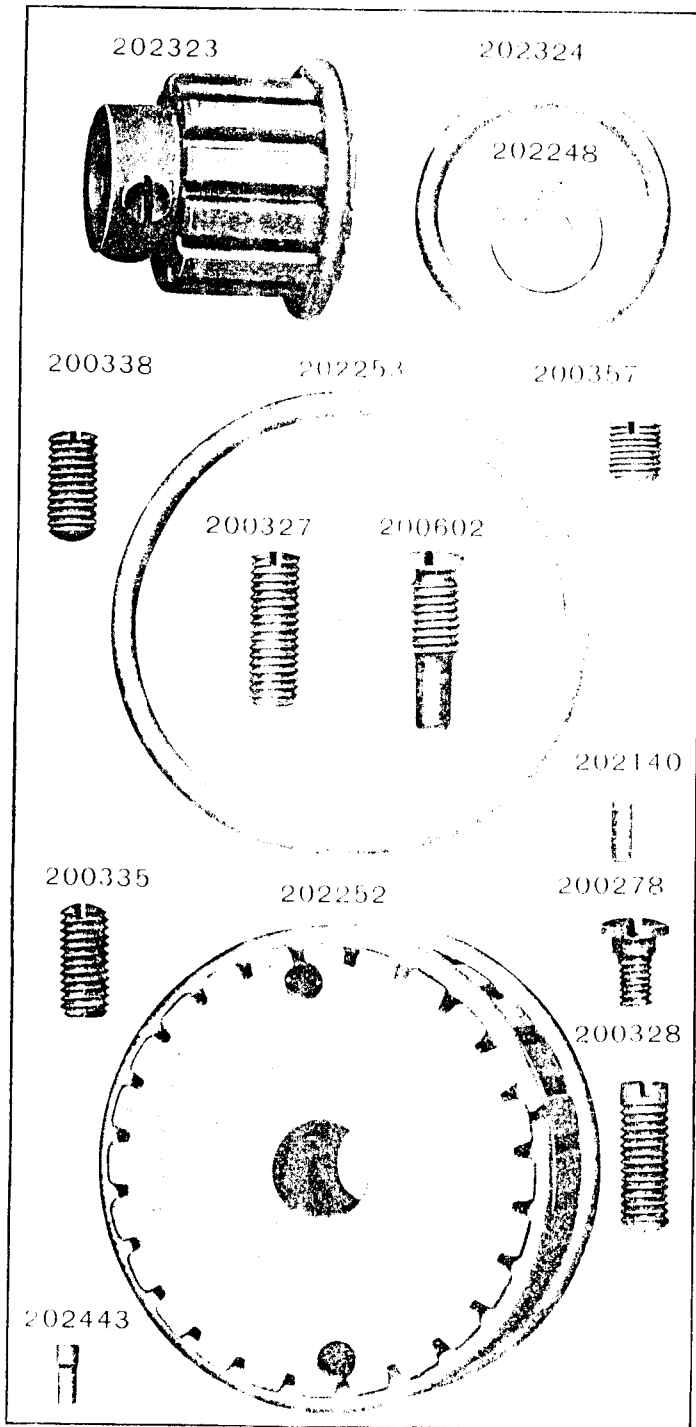


PLATE 10245-FULL SIZE

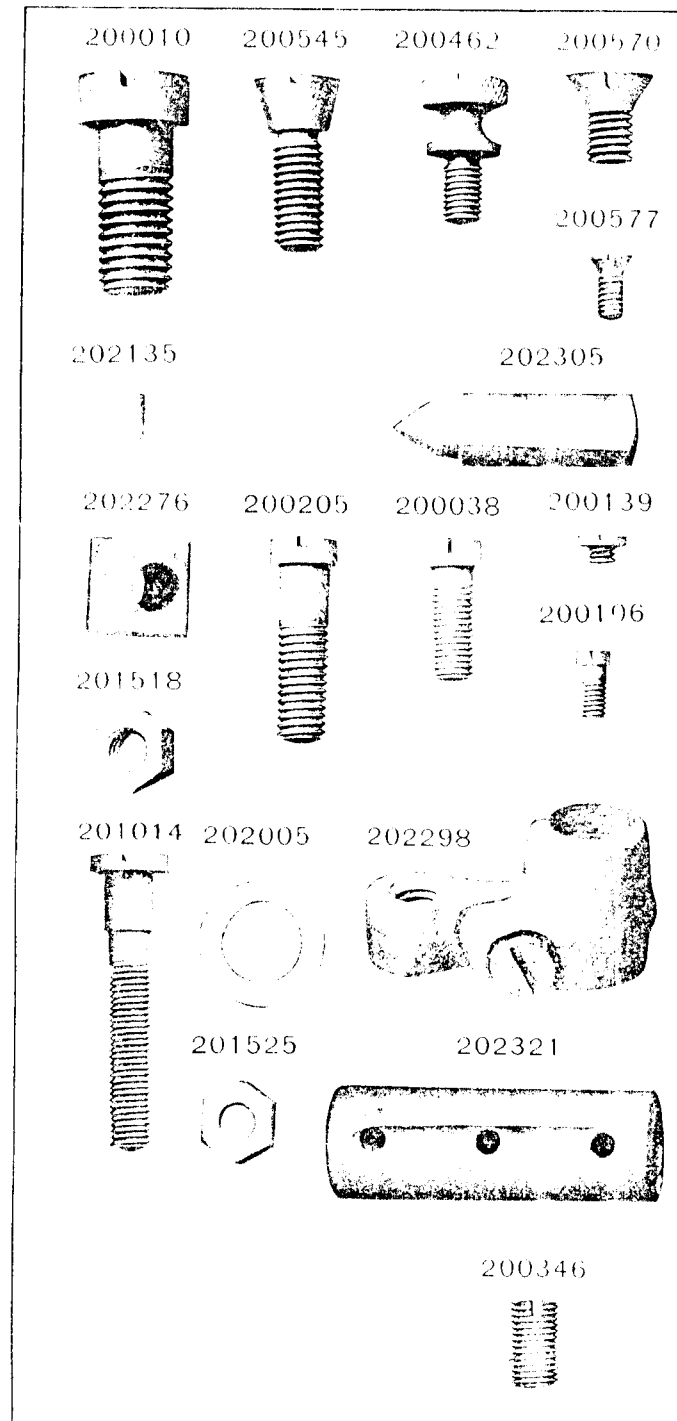


PLATE 10246-FULL SIZE

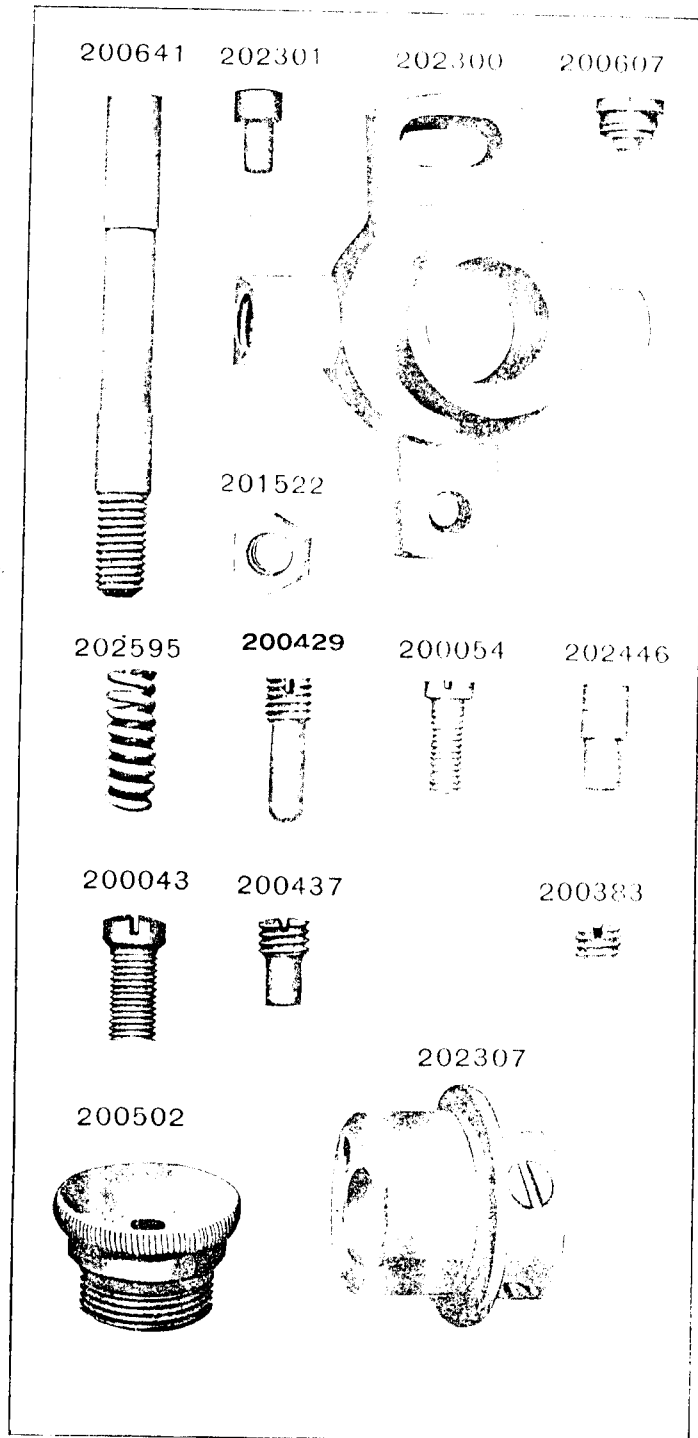


PLATE 10247-FULL SIZE

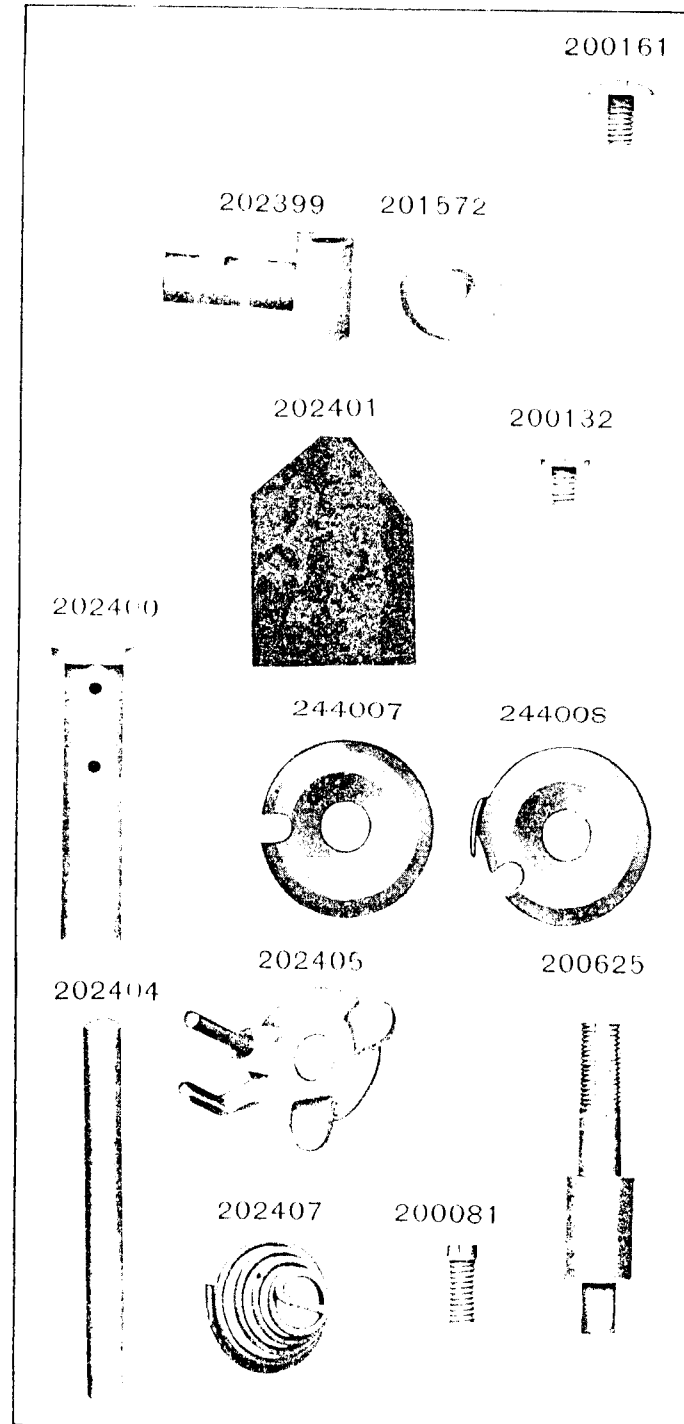
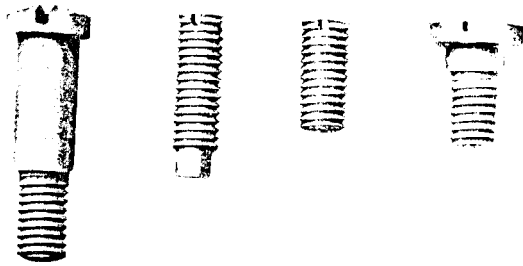
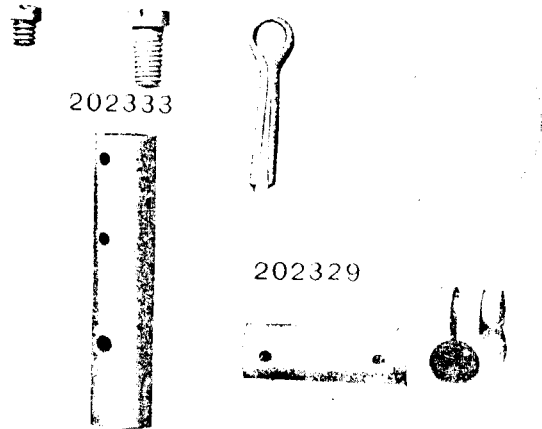


PLATE 10248—FULL SIZE

200224 200428 200335 200262



200141 200086 202302 203172



202333

202329

200352

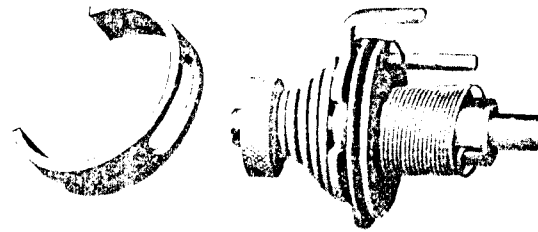


200363

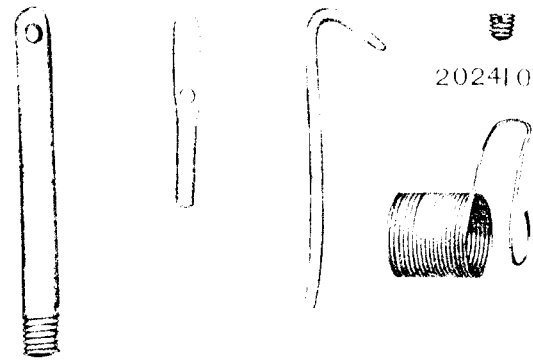


PLATE 10252—FULL SIZE

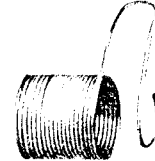
202411 202409



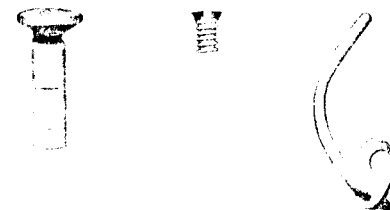
202412 202413 202414 200389



202410



204058 200582 202415



200355 202091 200366 202092

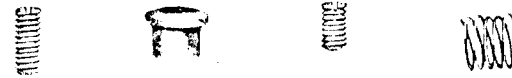


PLATE 10259—FULL SIZE

202368



202368



202369



202369



202370



202370



PLATE 10263—FULL SIZE

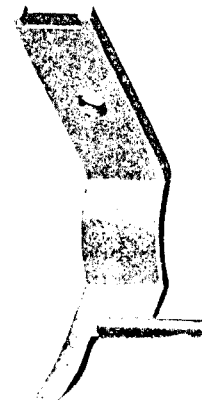
202390



202390



202356



202356



PLATE 10309—FULL SIZE

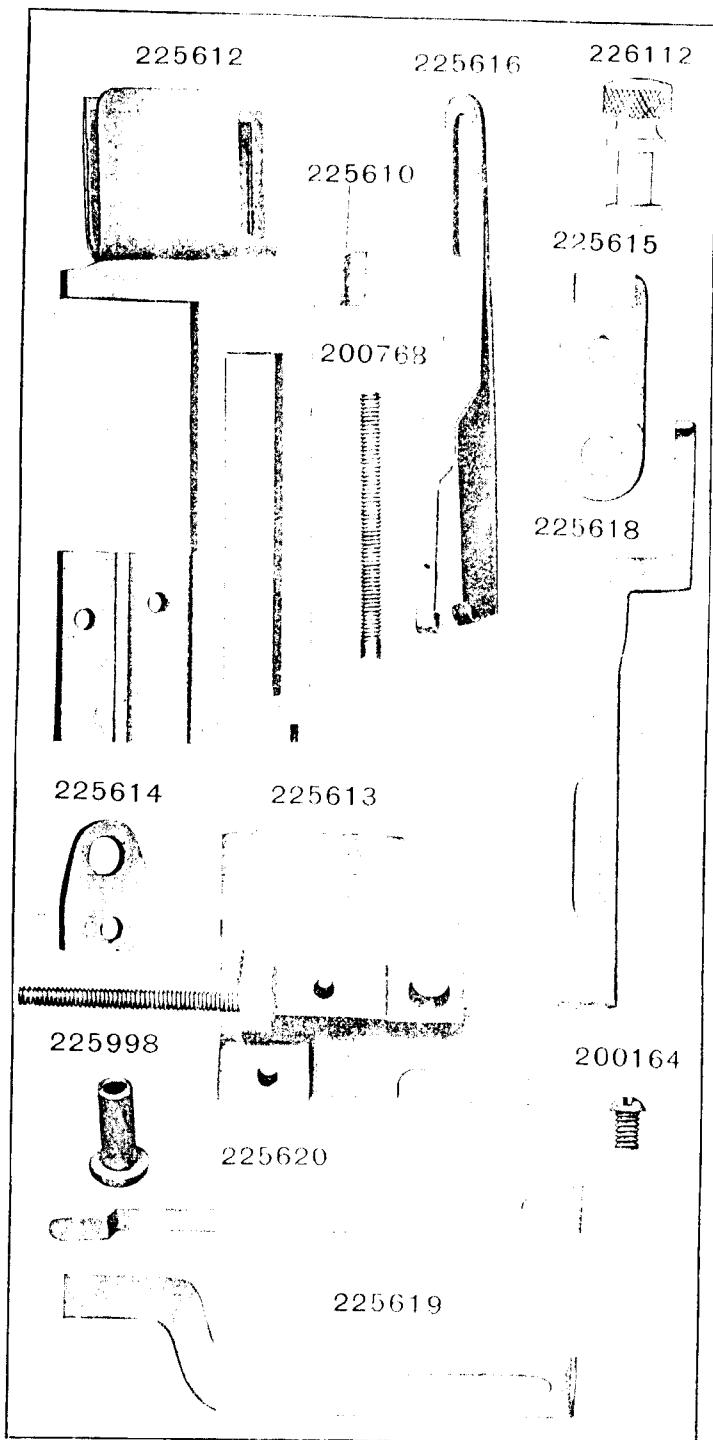


PLATE 10310—FULL SIZE

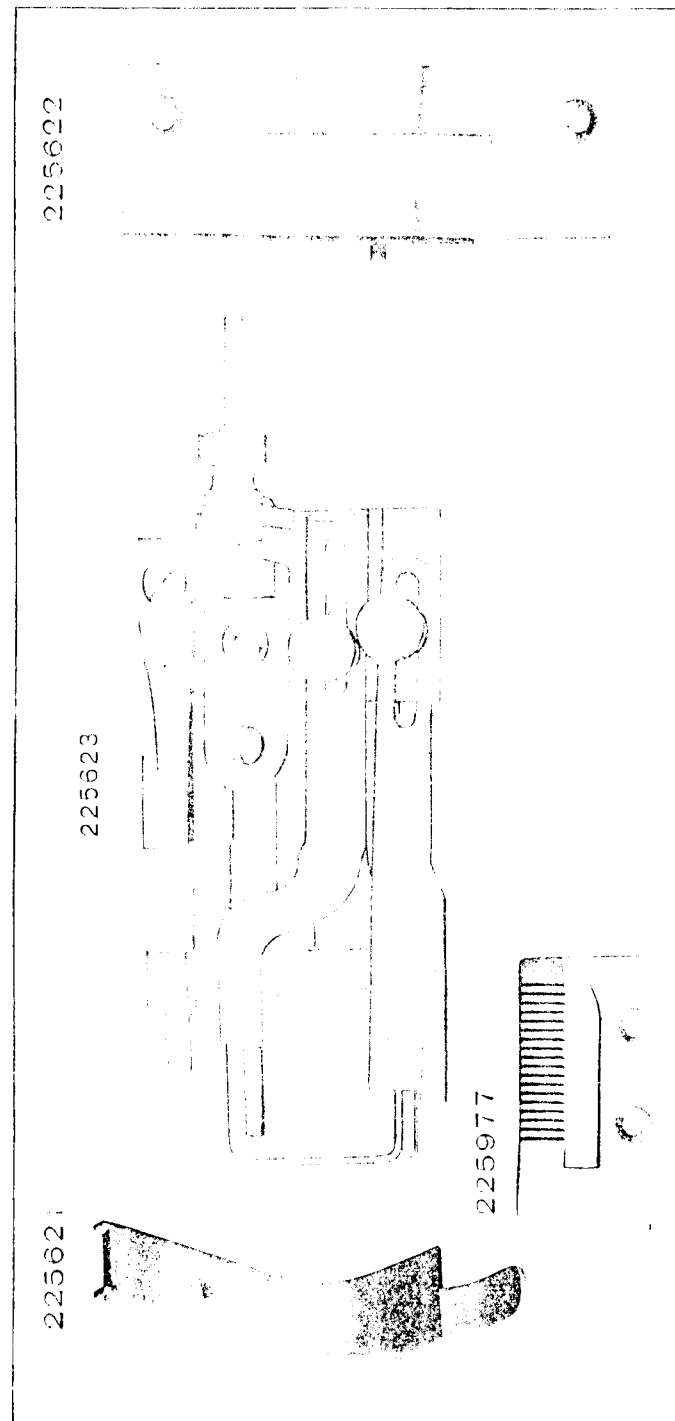
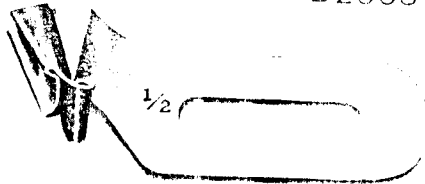


PLATE 10312—FULL SIZE

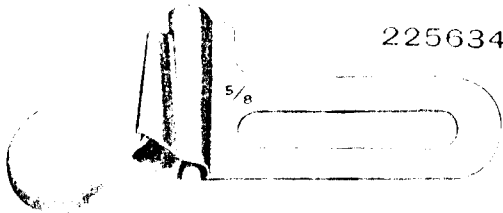
225630



225631



225634



202813



225633

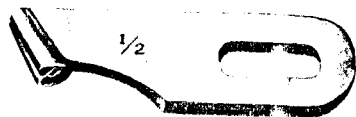


PLATE 10316—FULL SIZE

225659

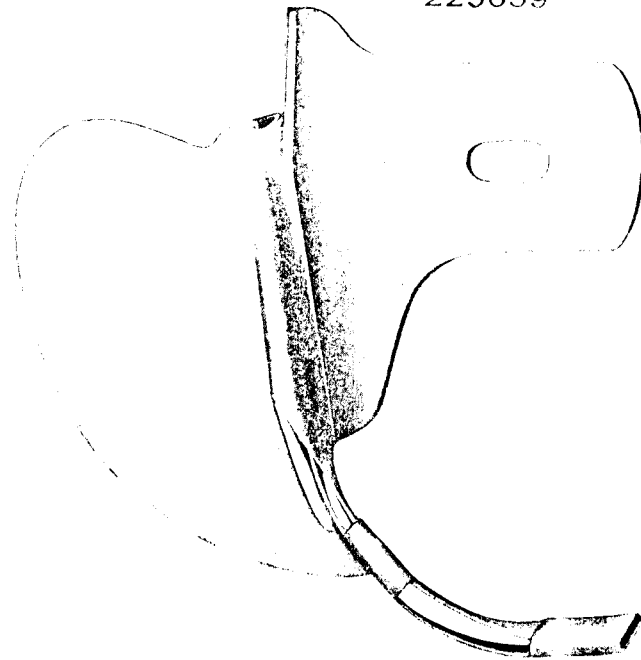


PLATE 10321—ONE-FOURTH SIZE

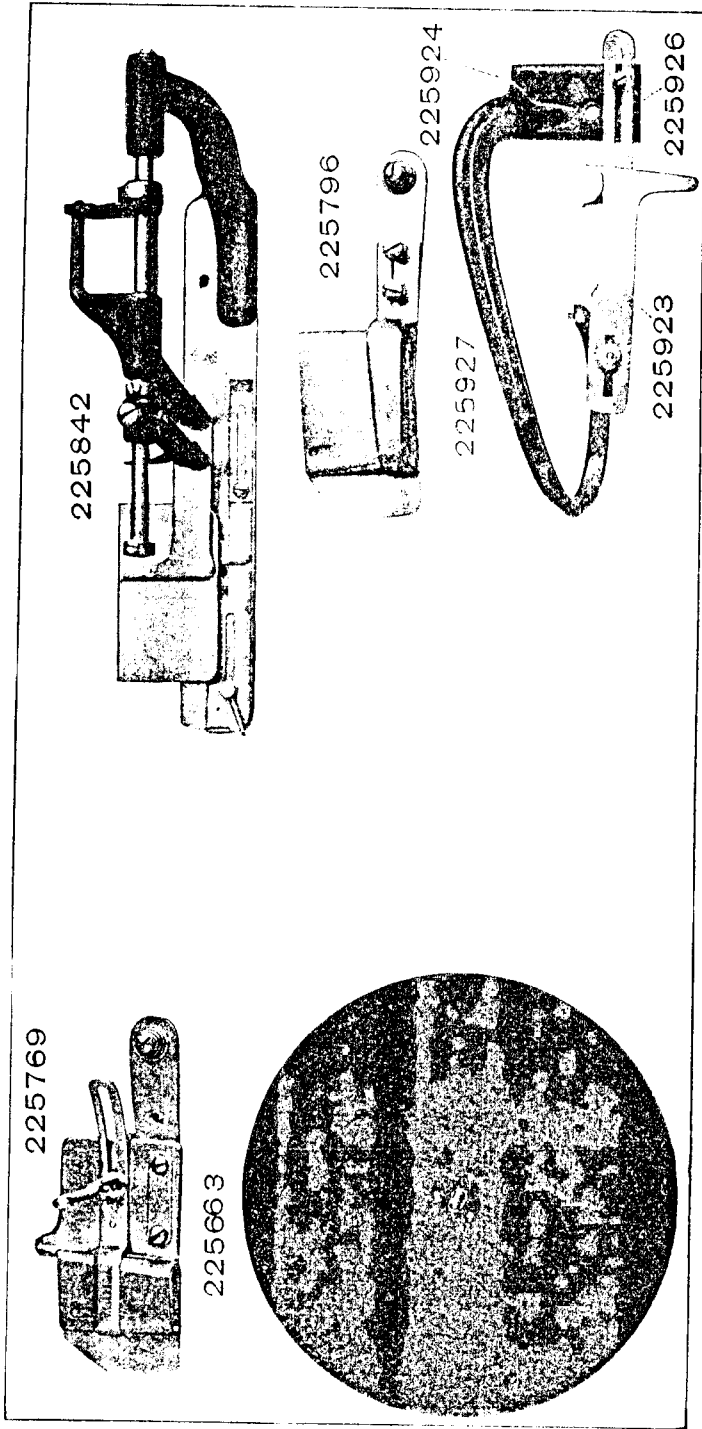


PLATE 10322—FULL SIZE

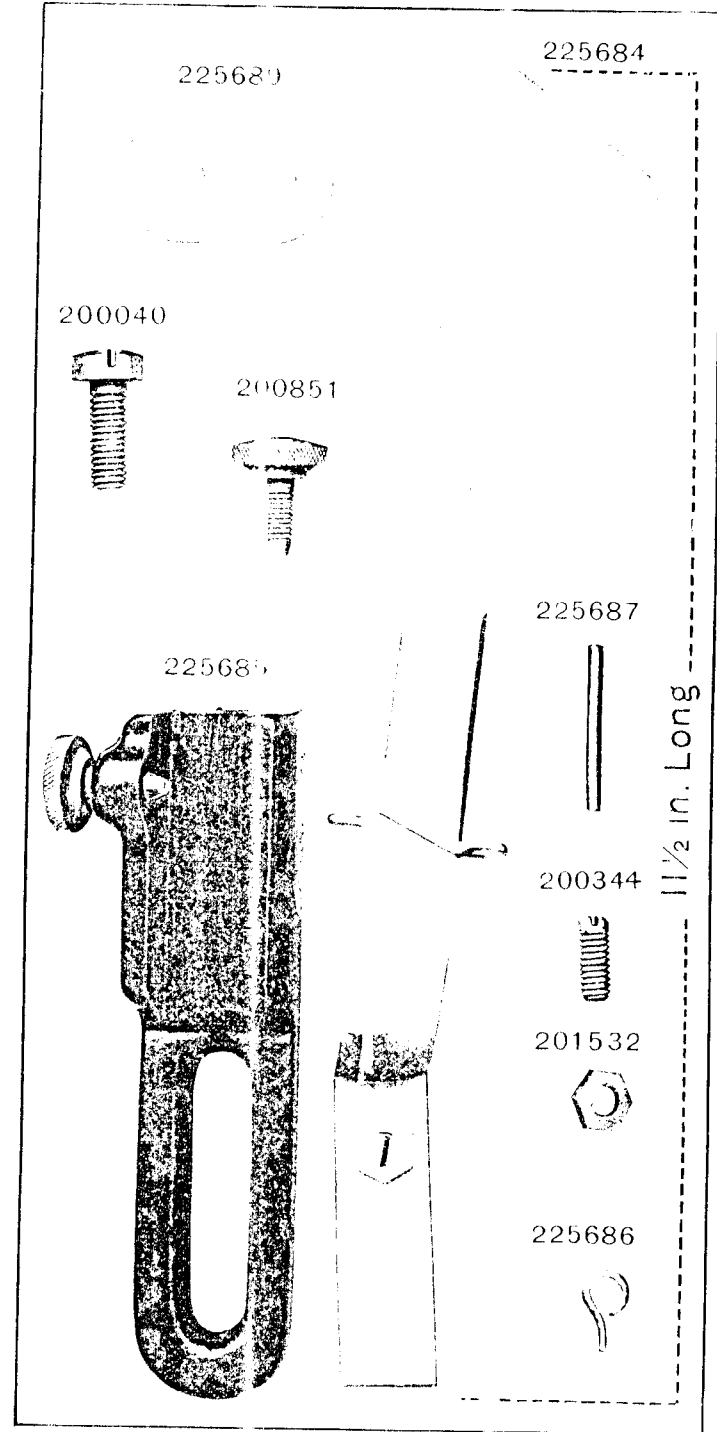


PLATE 10325—FULL SIZE

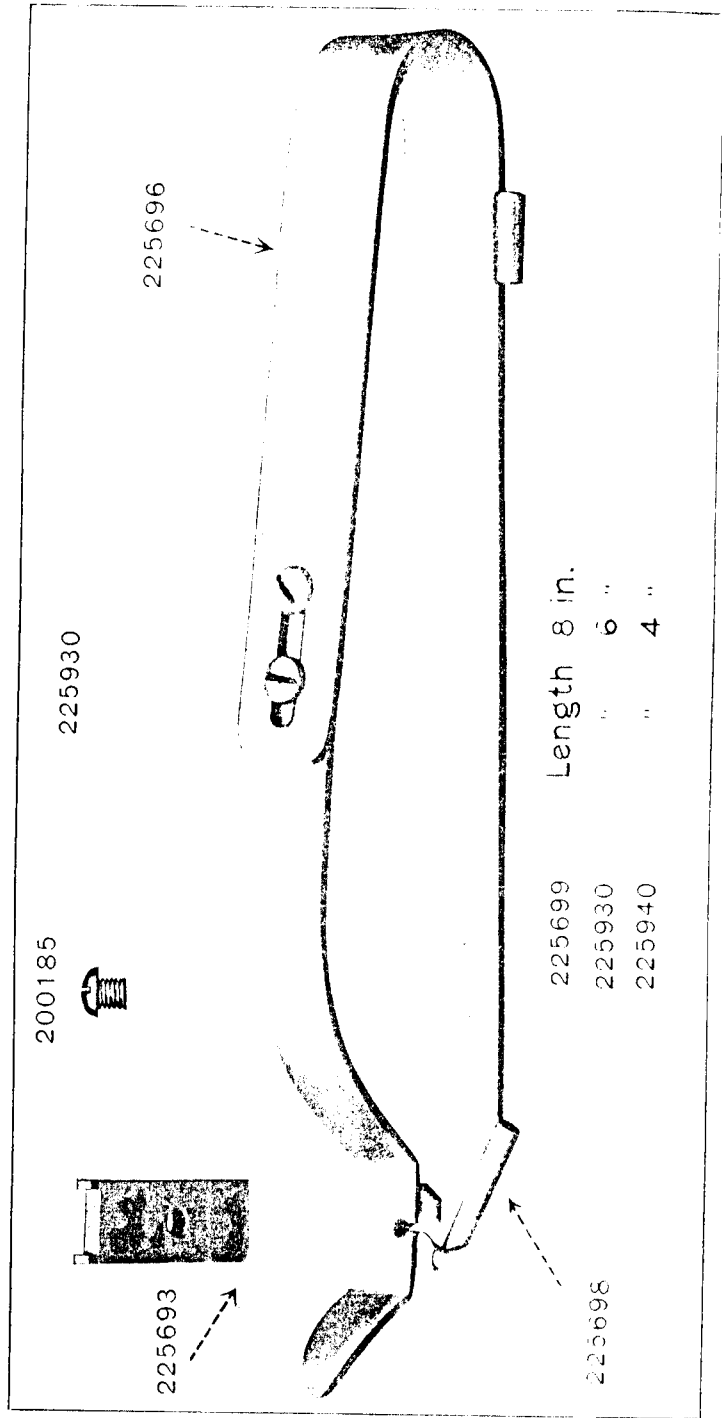


PLATE 10335—FULL SIZE

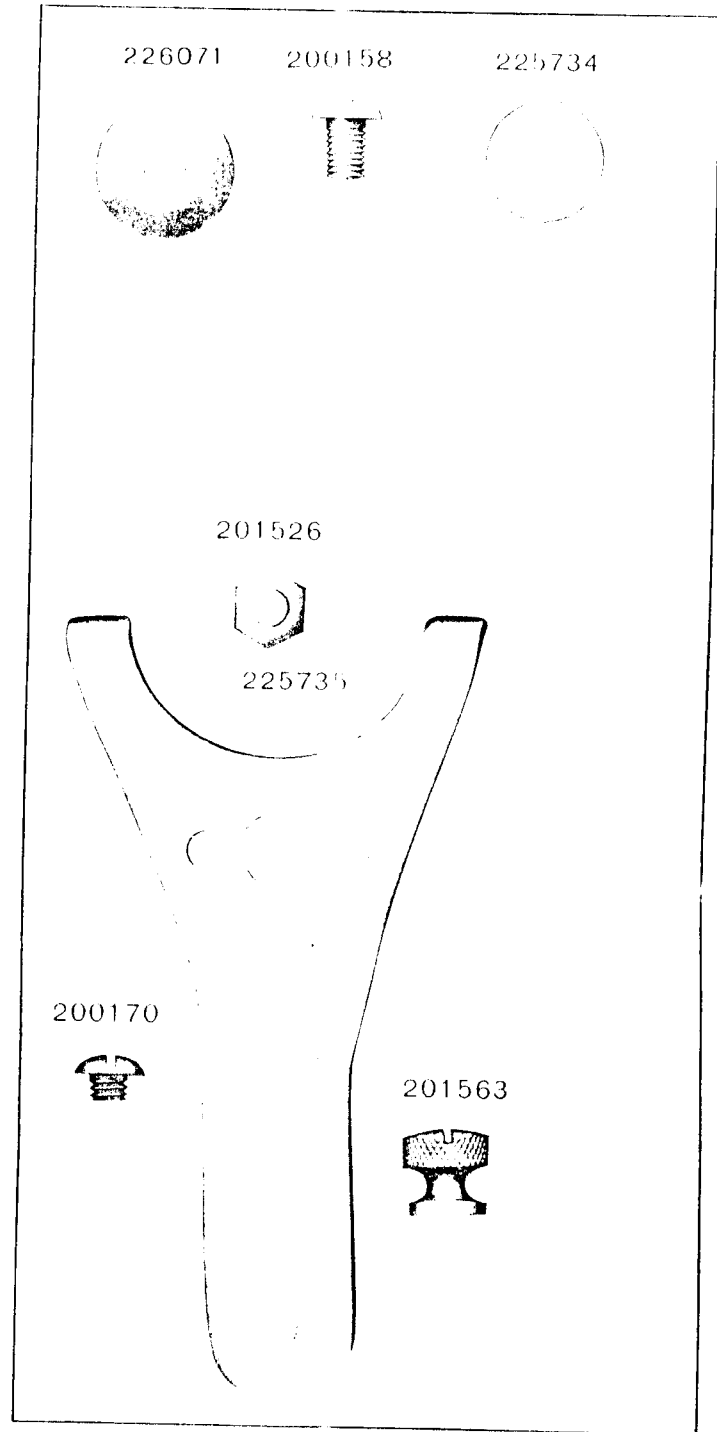


PLATE 10344—FULL SIZE

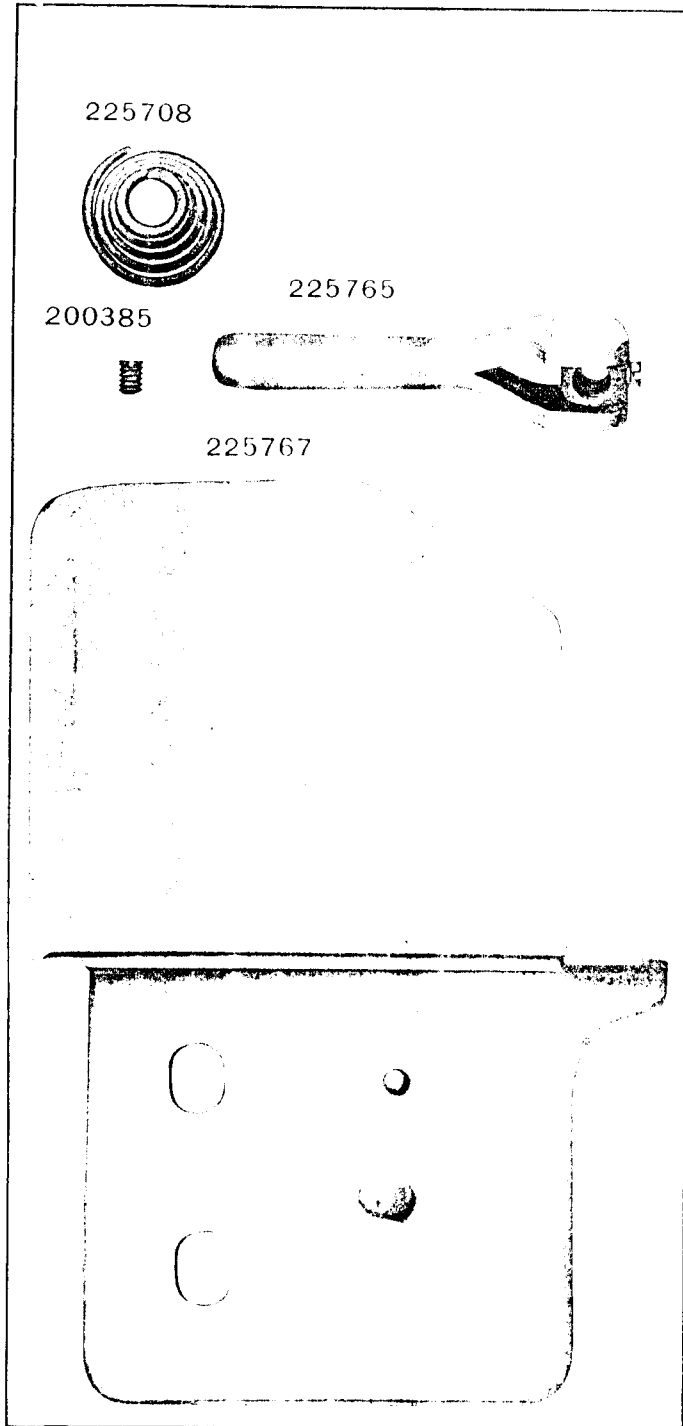


PLATE 10346—FULL SIZE

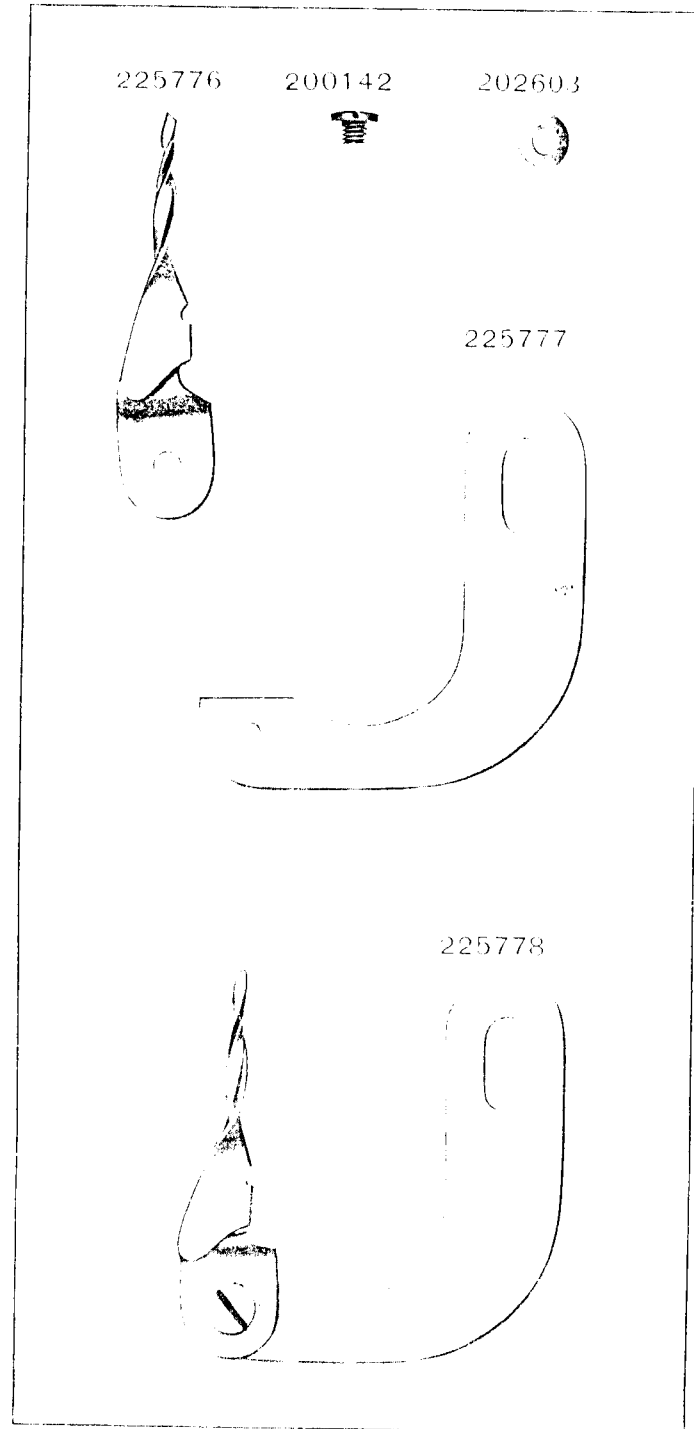


PLATE 10347—FULL SIZE

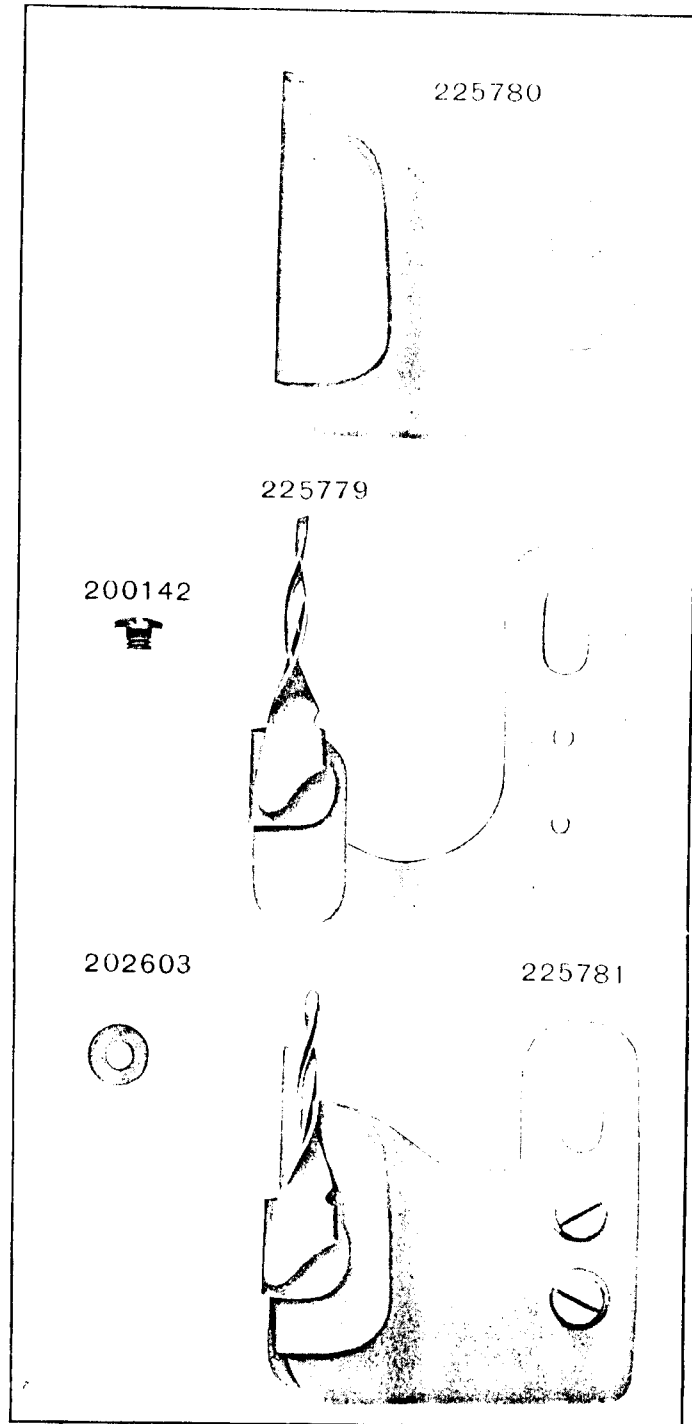


PLATE 10350—FULL SIZE

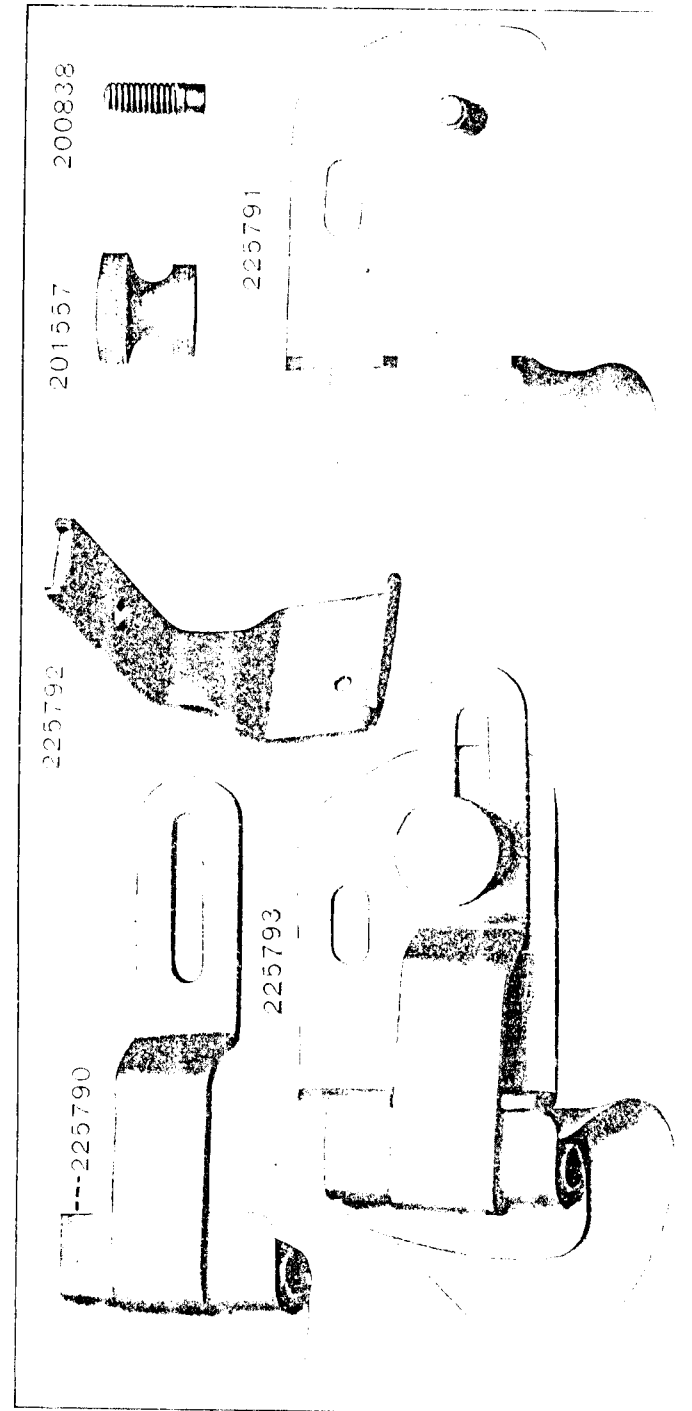


PLATE 10353—FULL SIZE

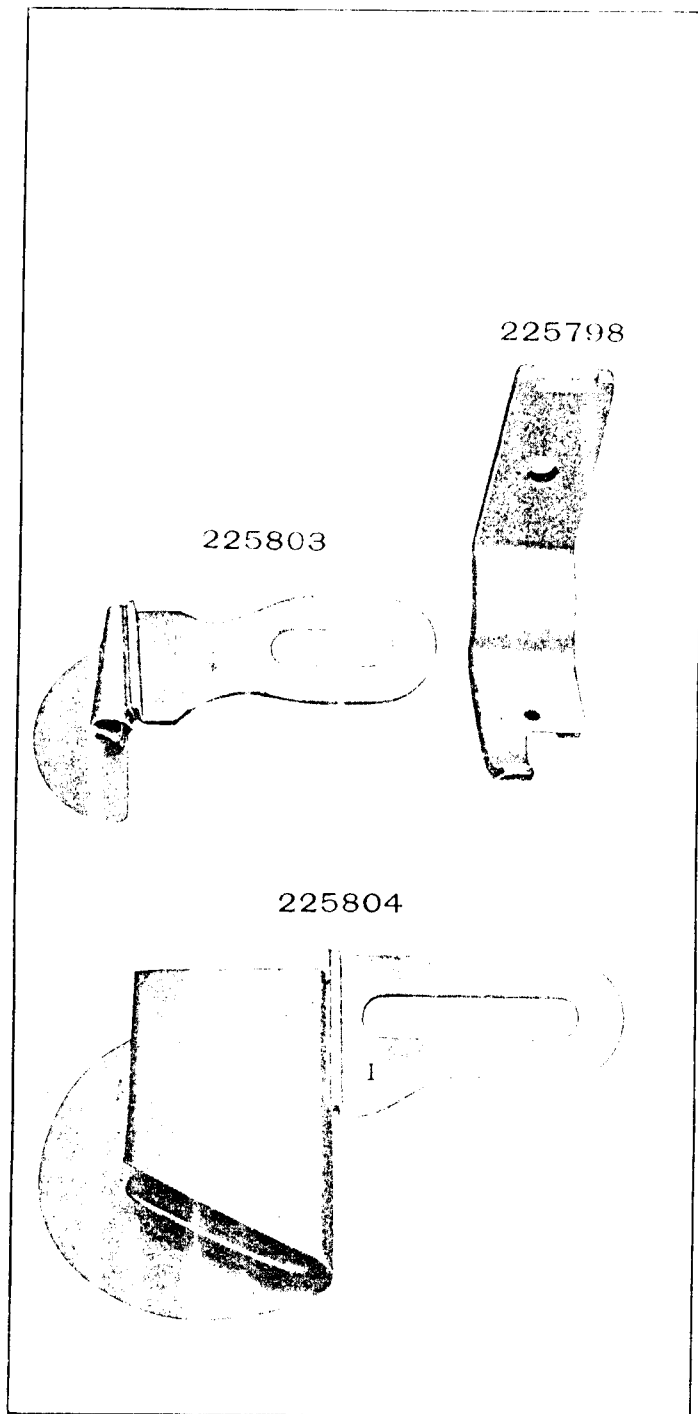


PLATE 10354—FULL SIZE

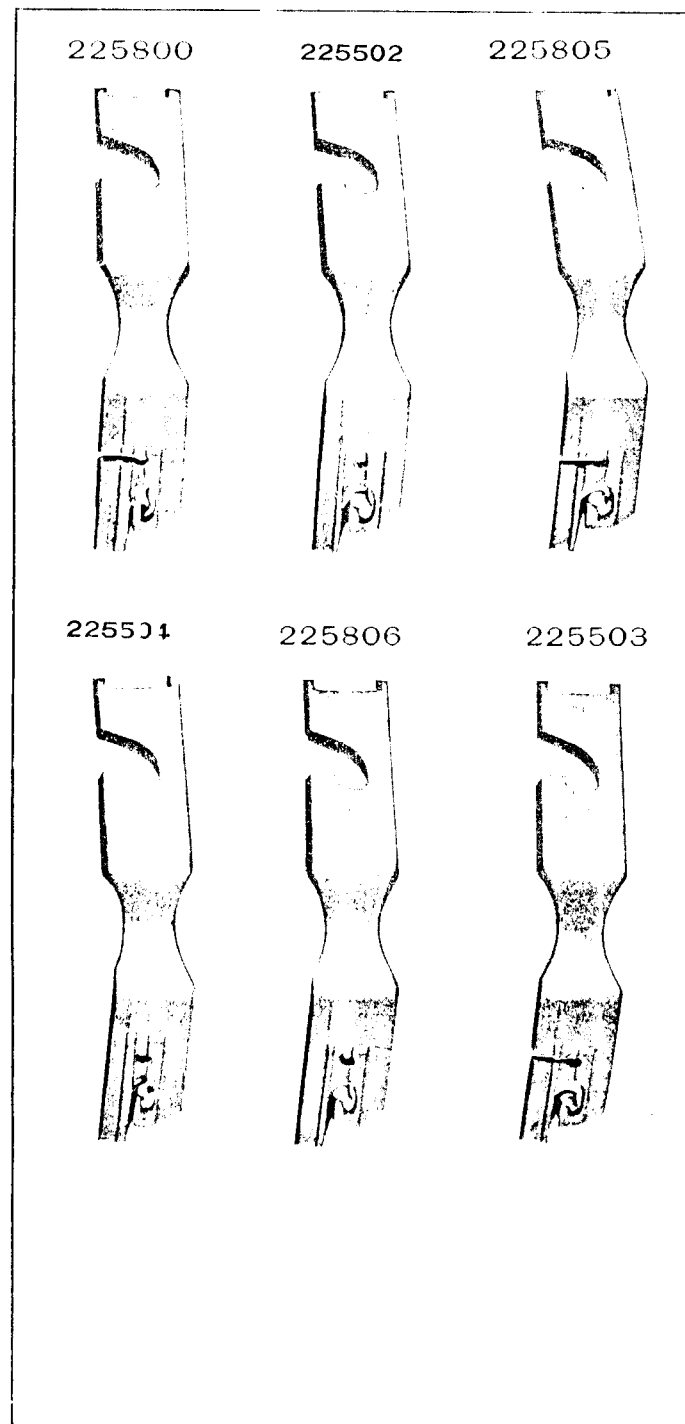


PLATE 10355—FULL SIZE

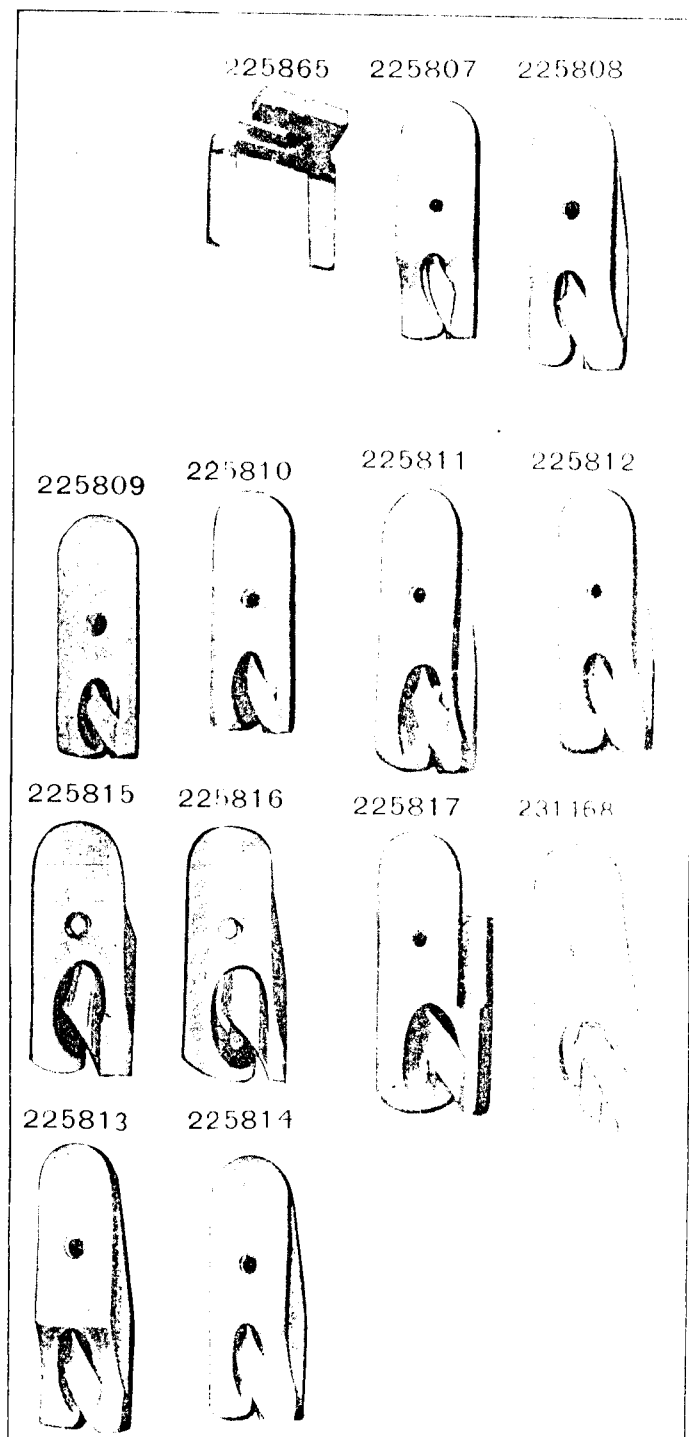


PLATE 10357—ONE-HALF SIZE

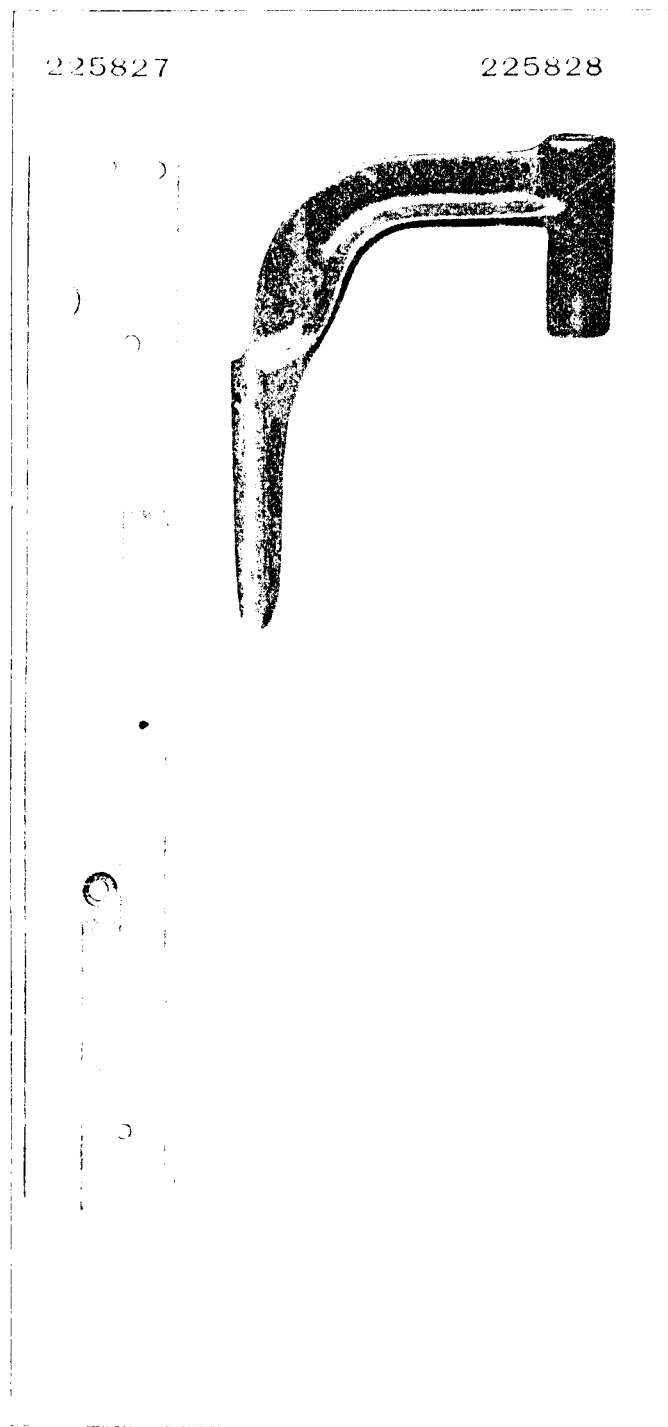


PLATE 10358—ONE-HALF SIZE

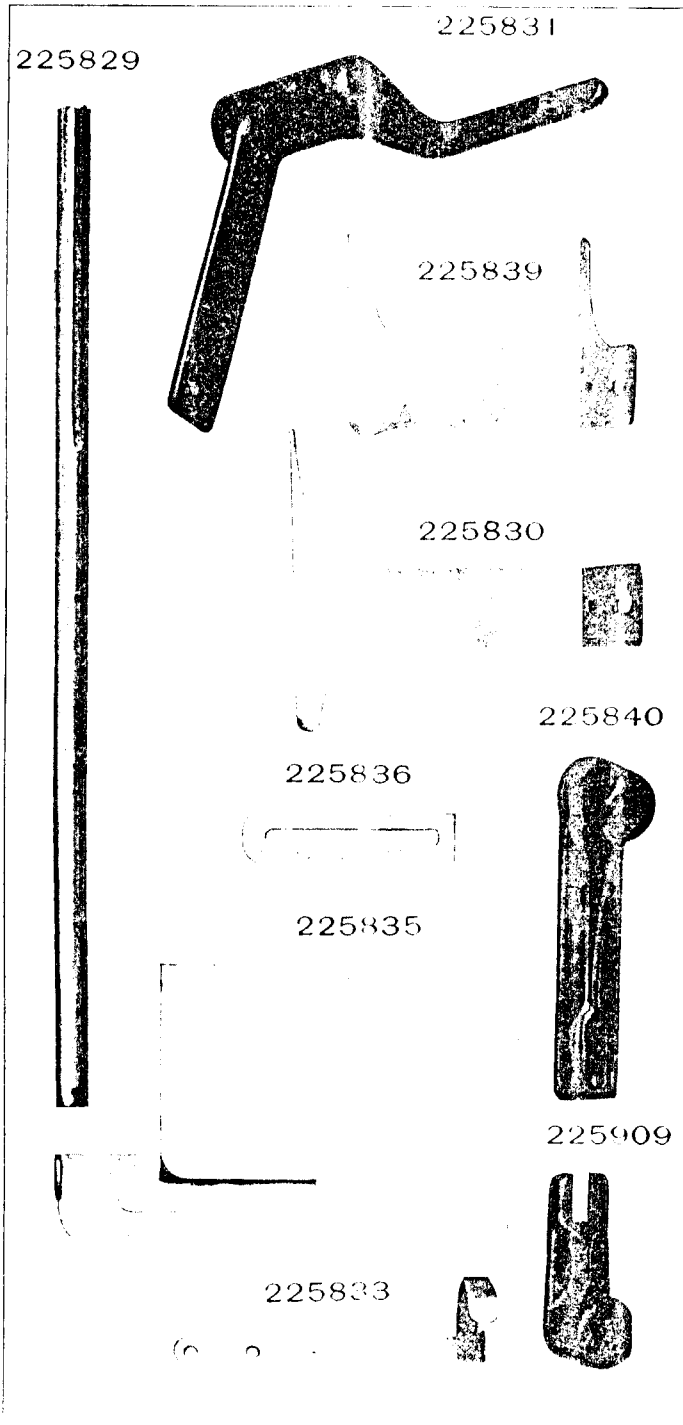


PLATE 10359—FULL SIZE

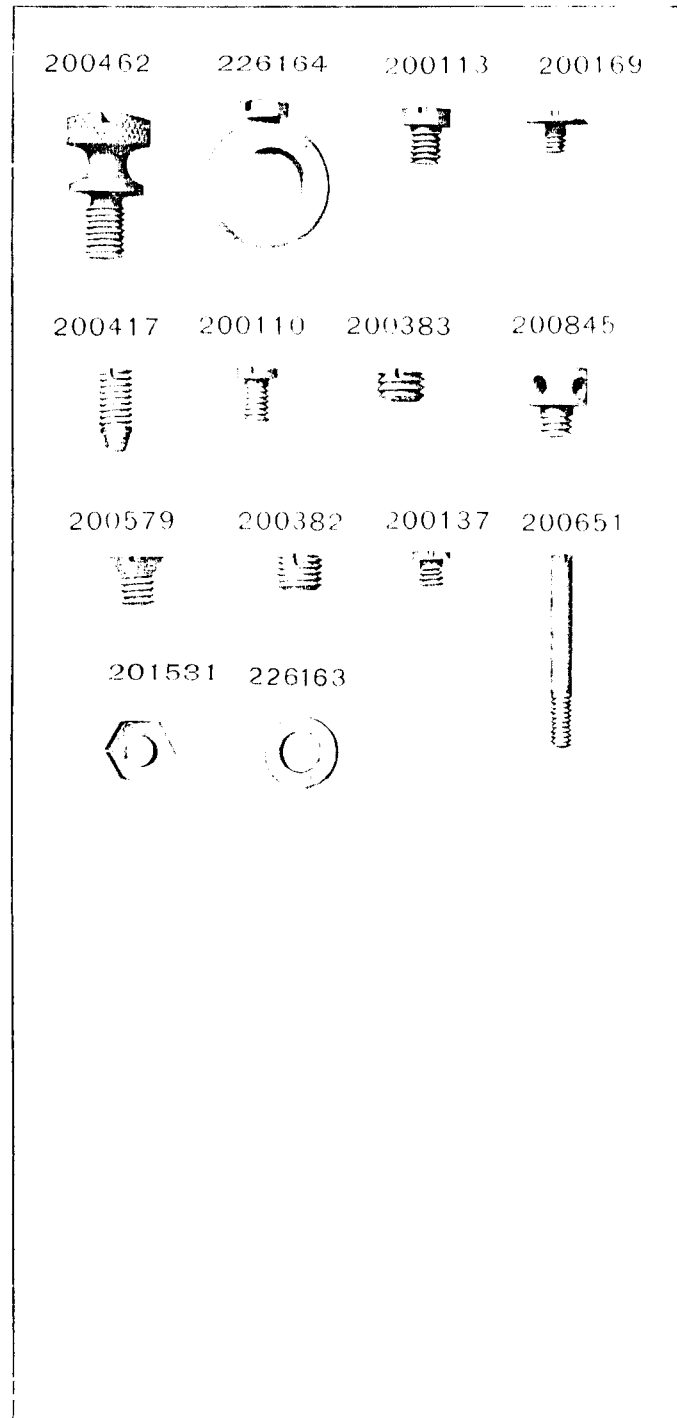


PLATE 10360—FULL SIZE

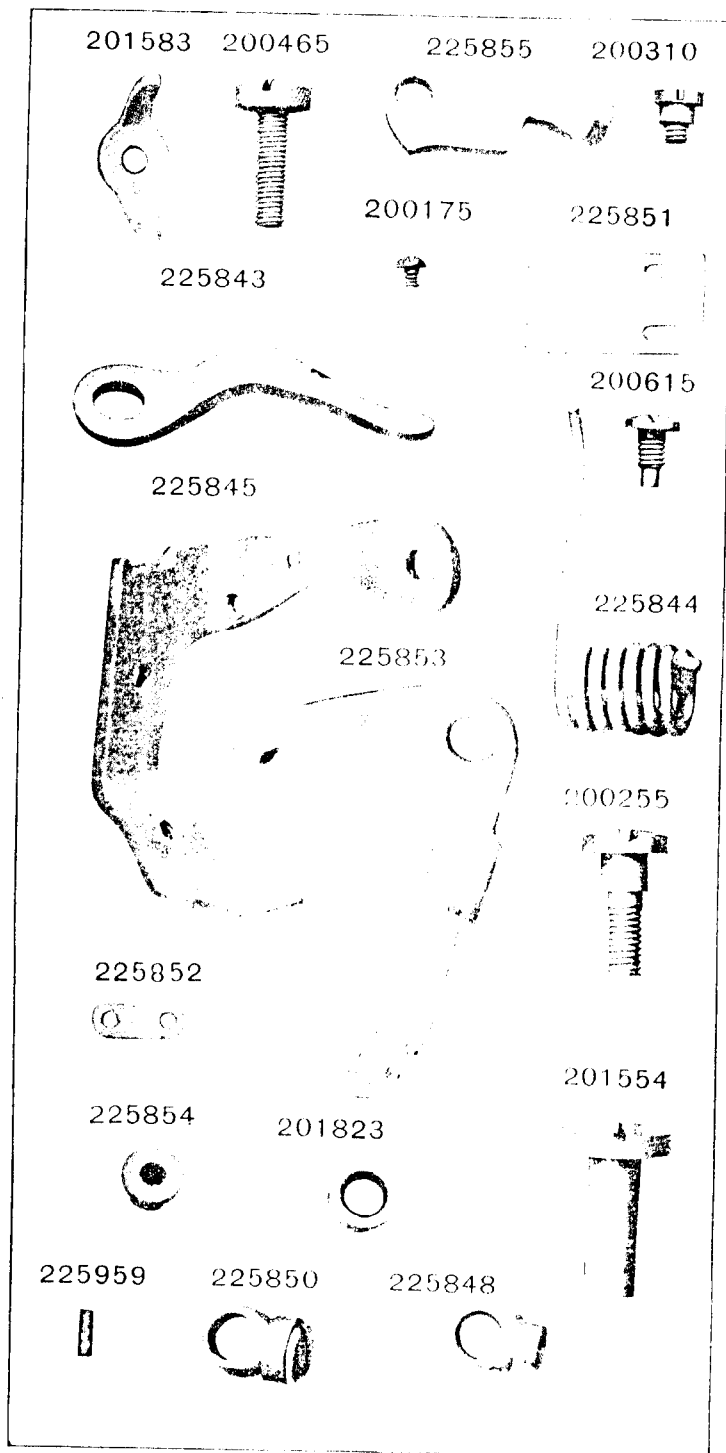


PLATE 10361—FULL SIZE

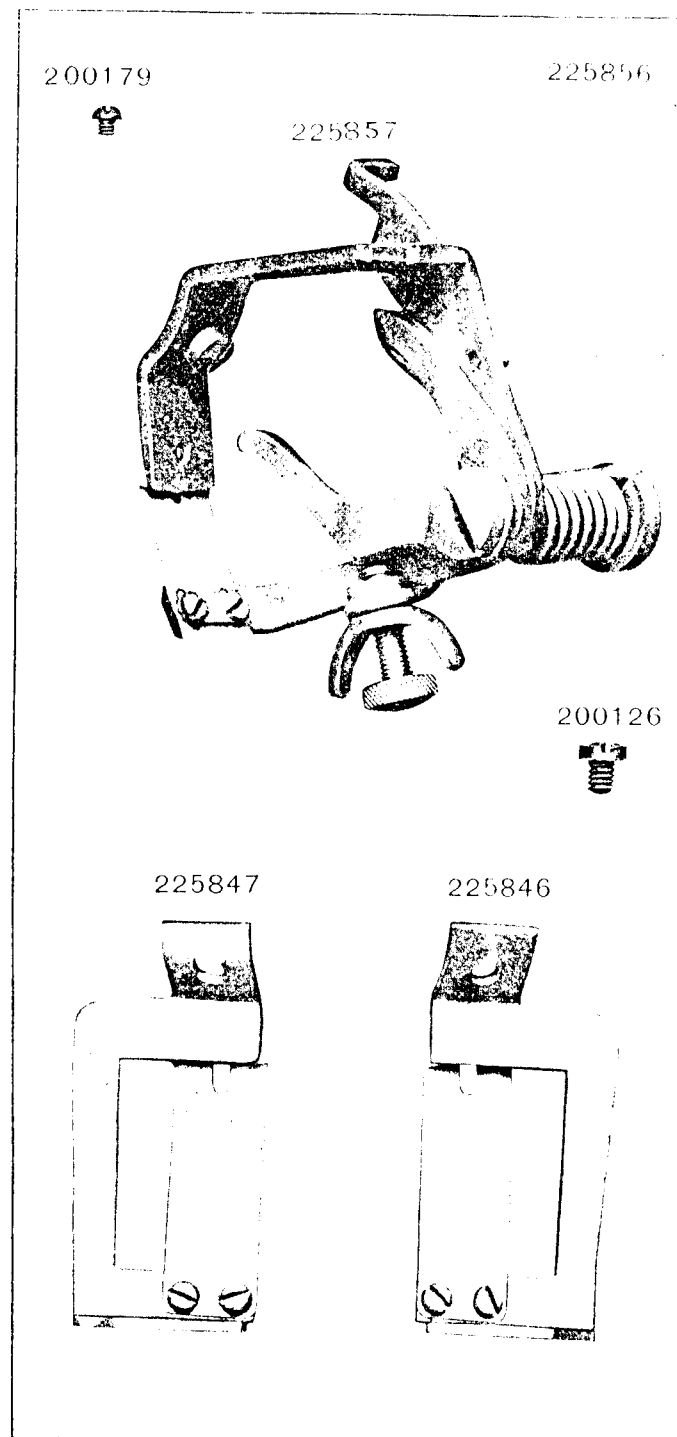


PLATE 10381—FULL SIZE

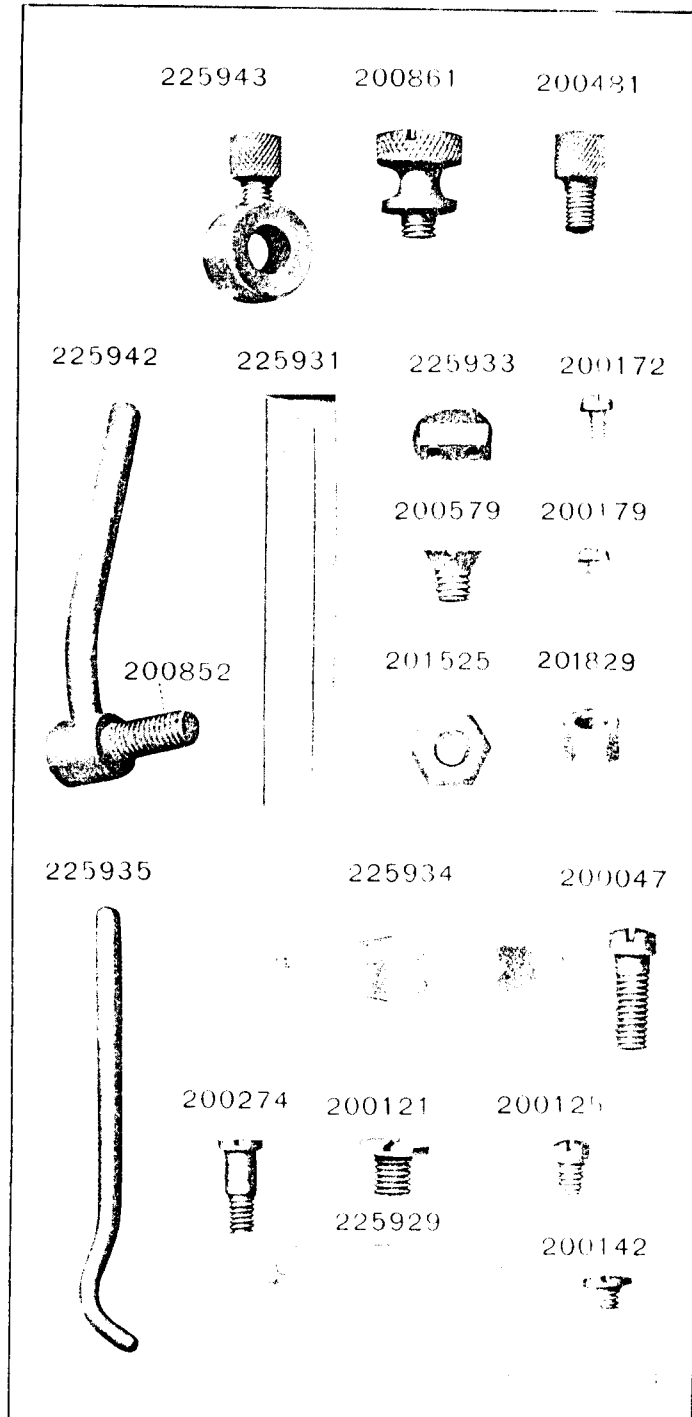


PLATE 10393—FULL SIZE

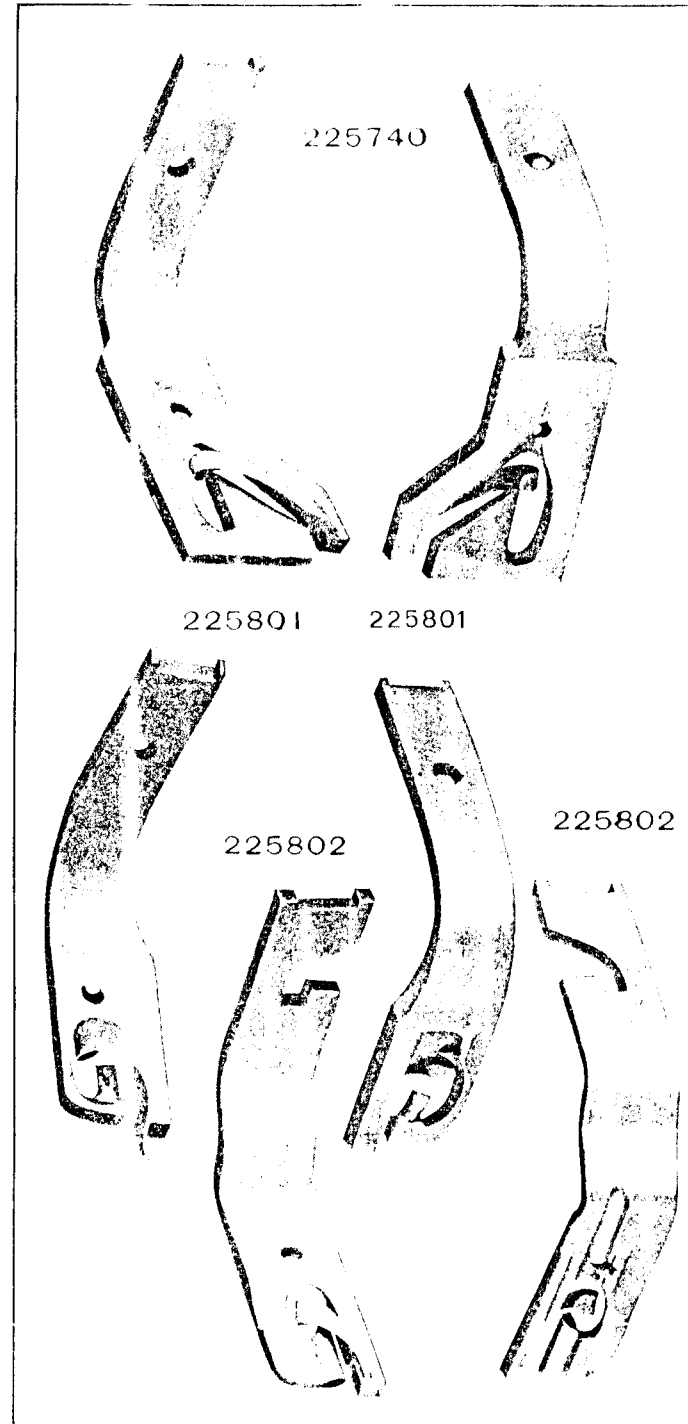


PLATE 10511 -FULL SIZE

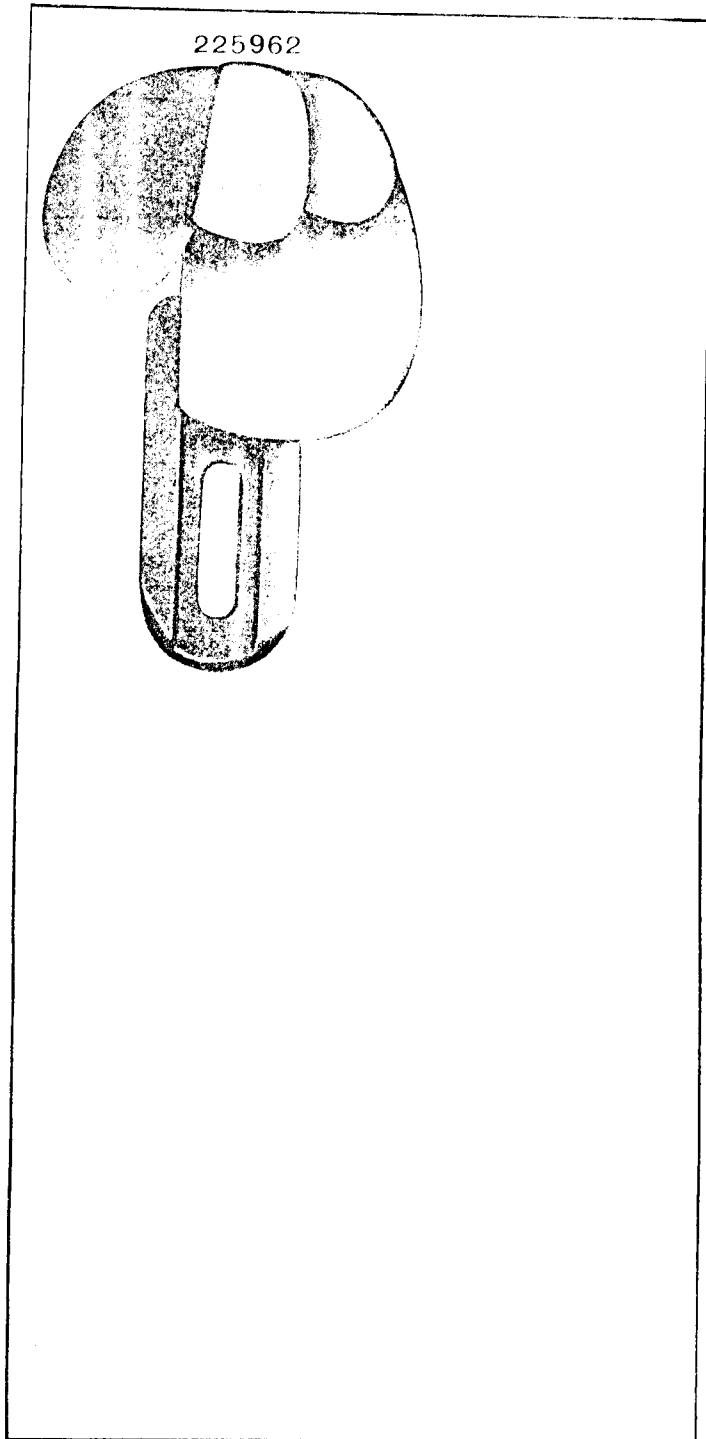


PLATE 10667 -ONE - HALF SIZE

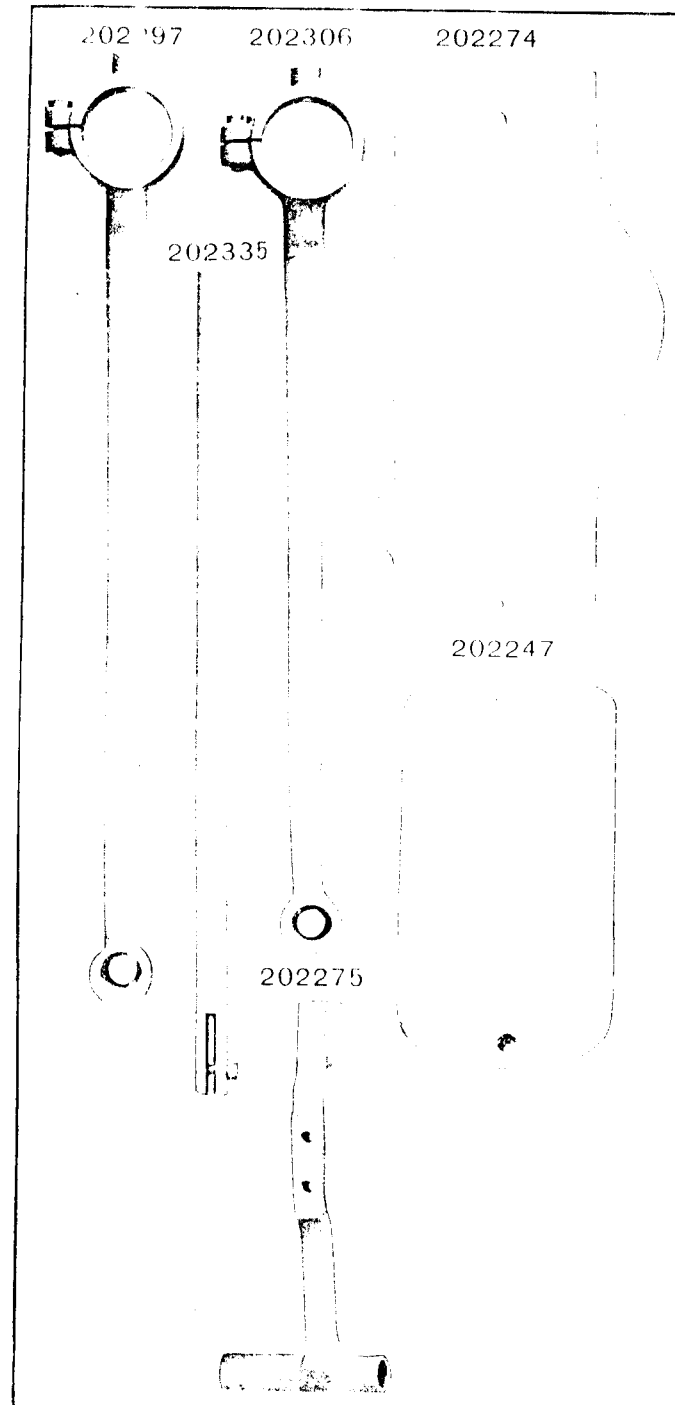
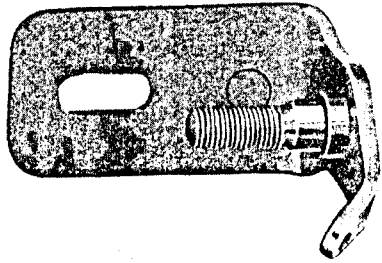


PLATE 10881-FULL SIZE

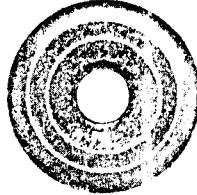
225461



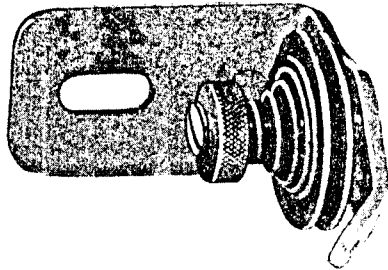
200082 202104



2102



225462



202407



201499

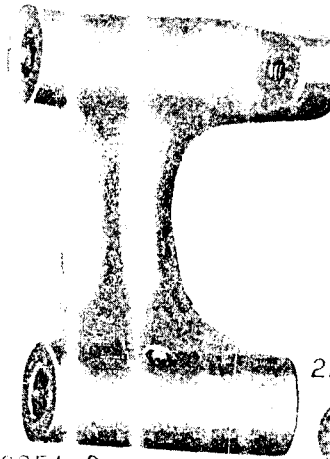


201572

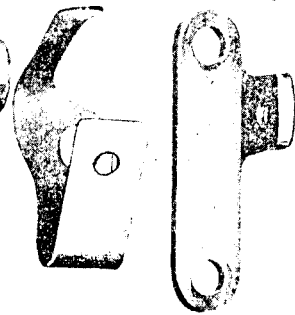


PLATE 10884-FULL SIZE

225453



225444 202478



225458



228026



225450



225451



200299



225458



200056



225459



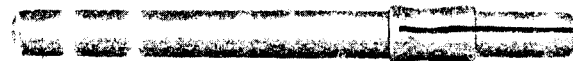
200105



225456



225381



225455

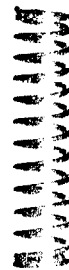


PLATE 10885—ONE-FOURTH SIZE

225433



202473

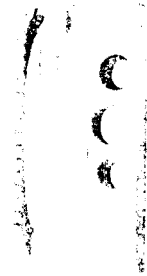


225382

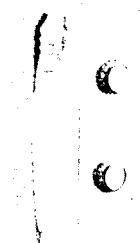


PLATE 10912 —FULL SIZE

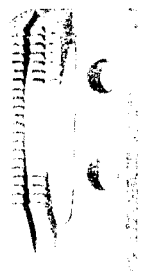
202290



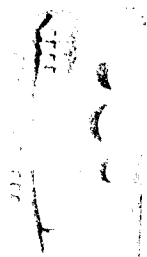
202293



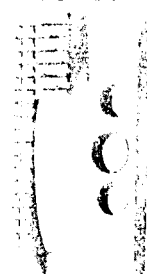
202294



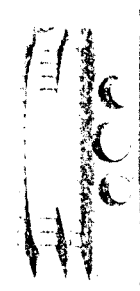
202295



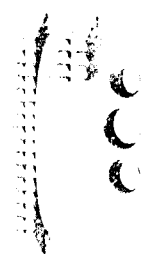
202296



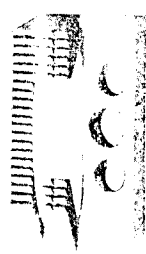
202970



203071



203072

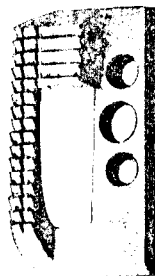


203083

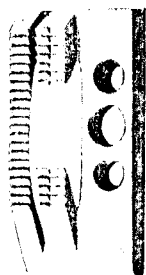


PLATE 10913 -FULL SIZE

202278



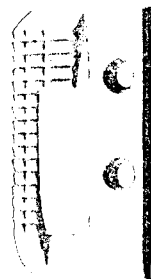
202281



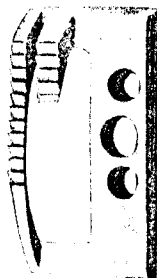
202282



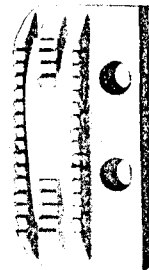
202283



202284



202287

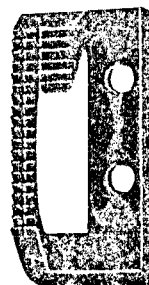


202289



PLATE 10915 -FULL SIZE

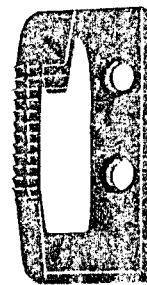
207051



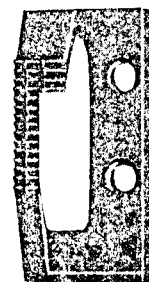
207052



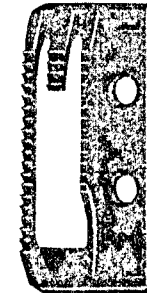
207053



207054



207055



207056

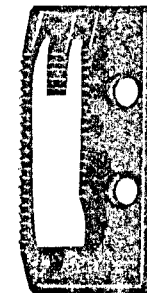


PLATE 10917 -FULL SIZE

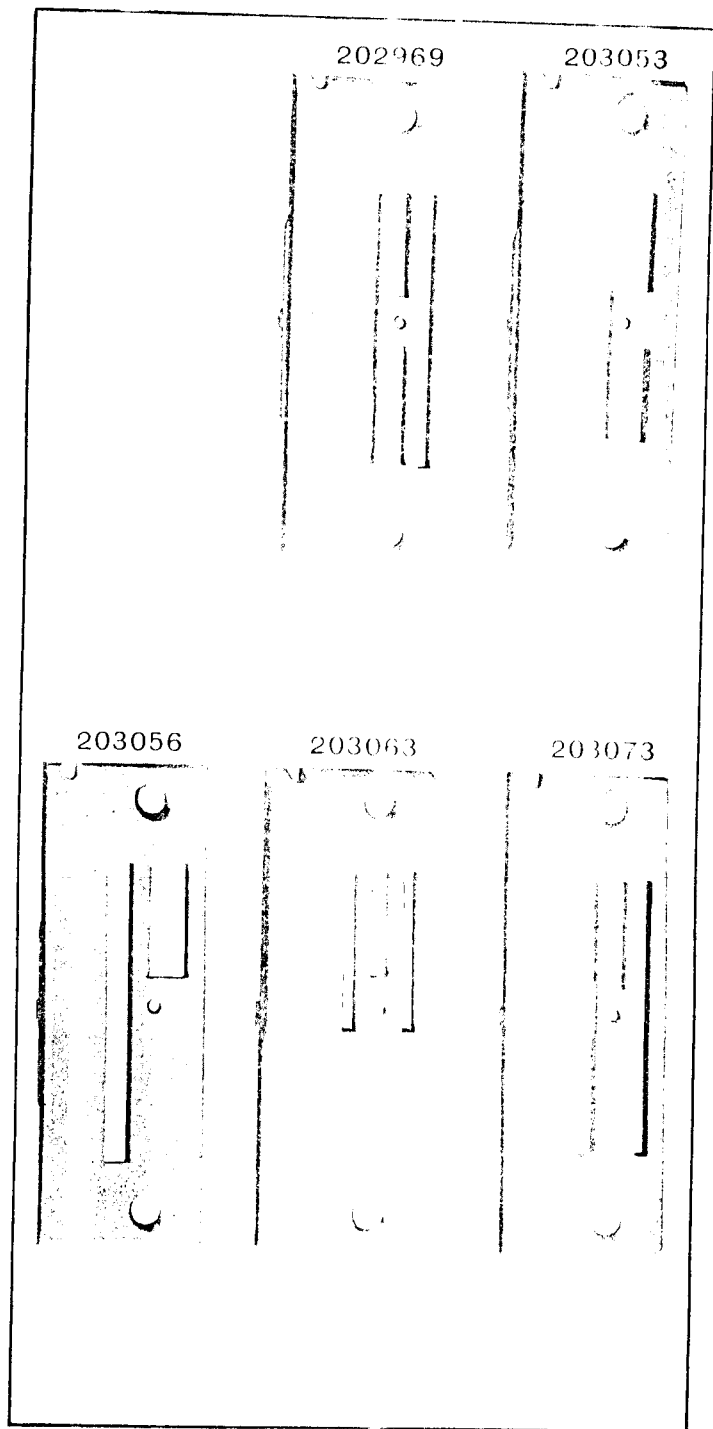


PLATE 10923 -FULL SIZE

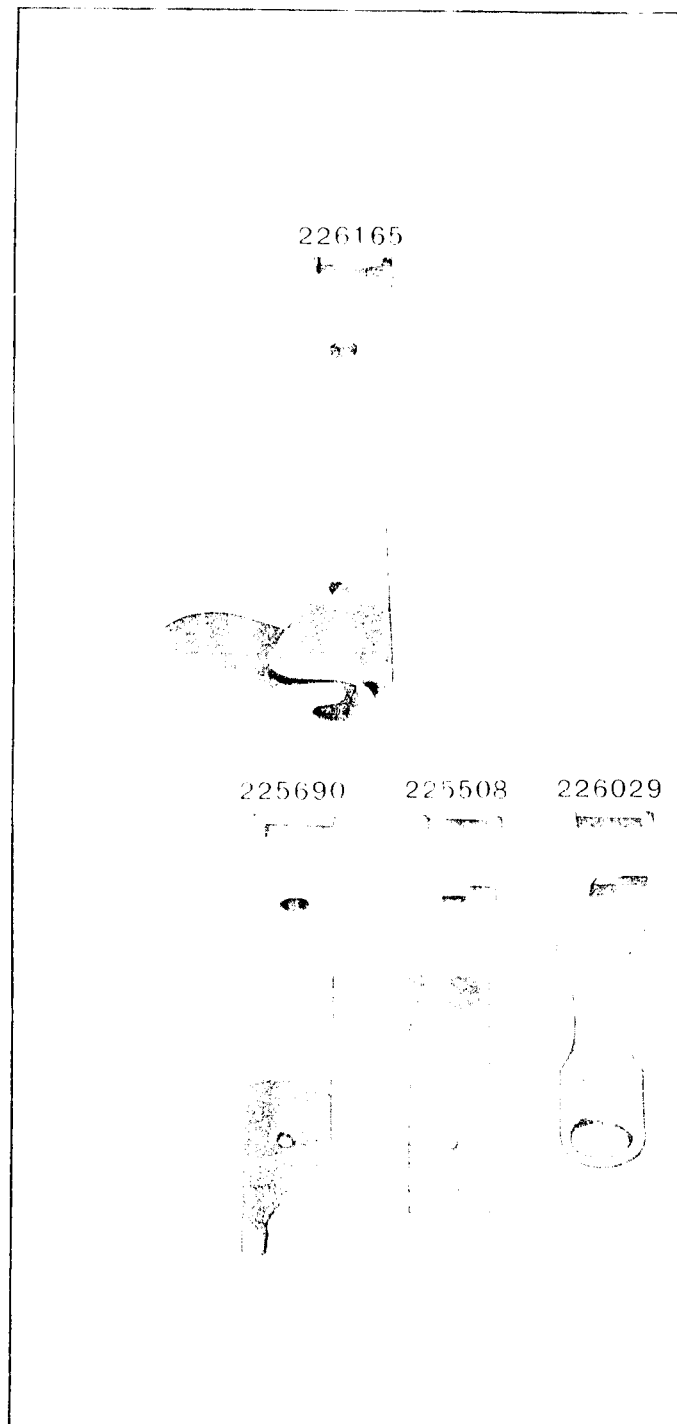


PLATE 10925 - FULL SIZE

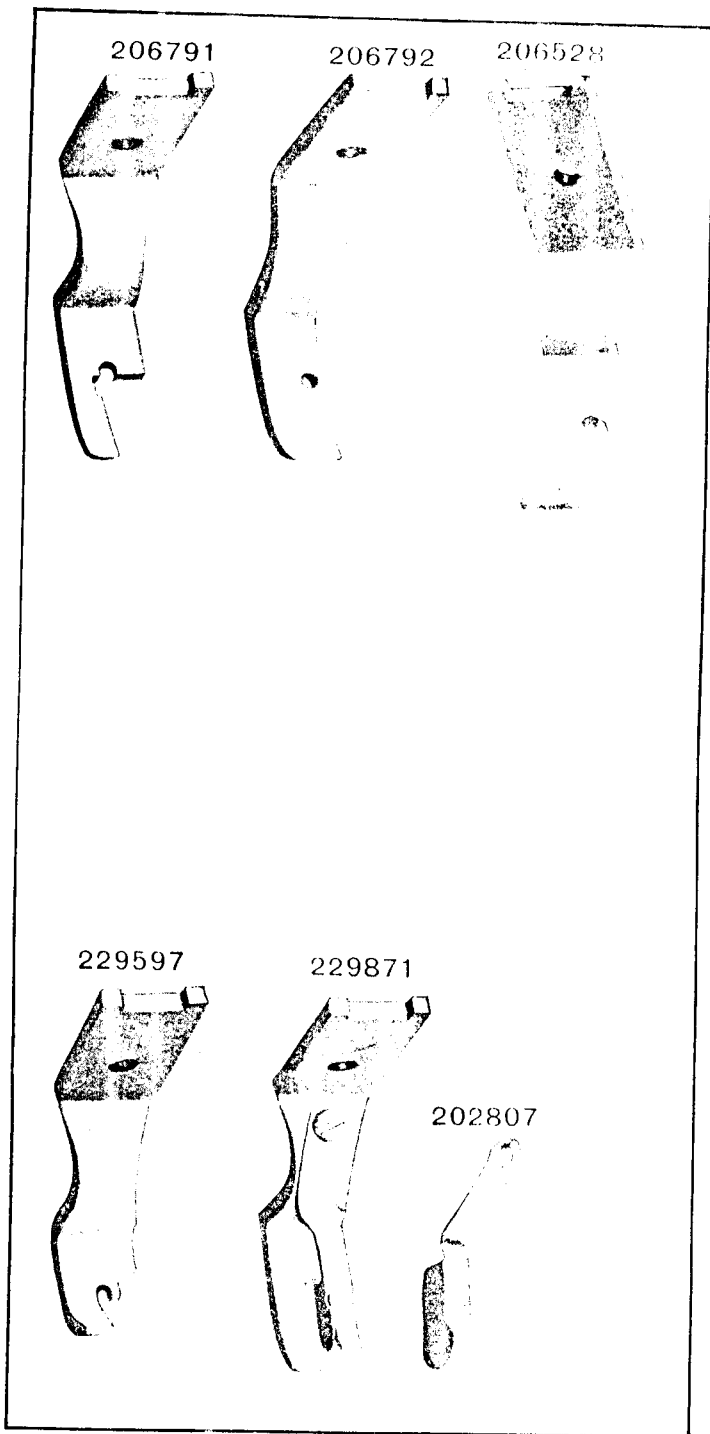


PLATE 10926 - FULL SIZE

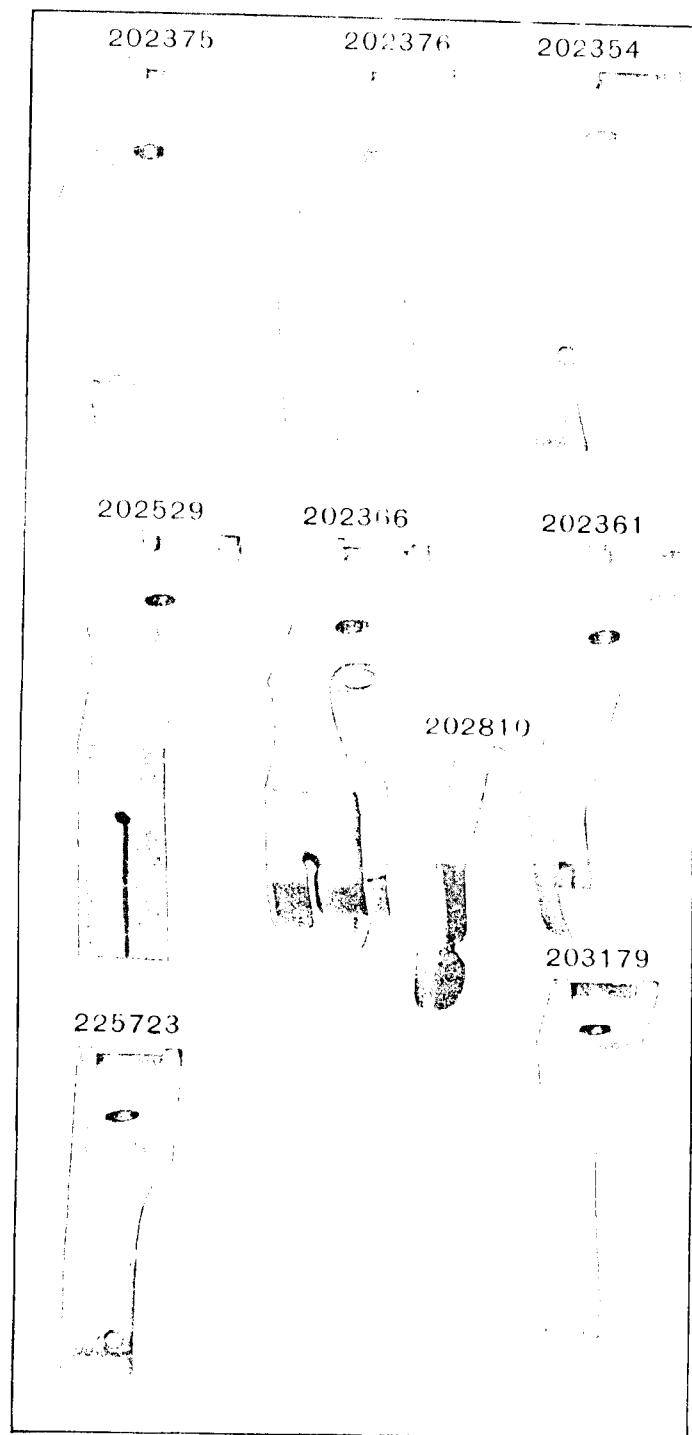


PLATE 10927 -FULL SIZE

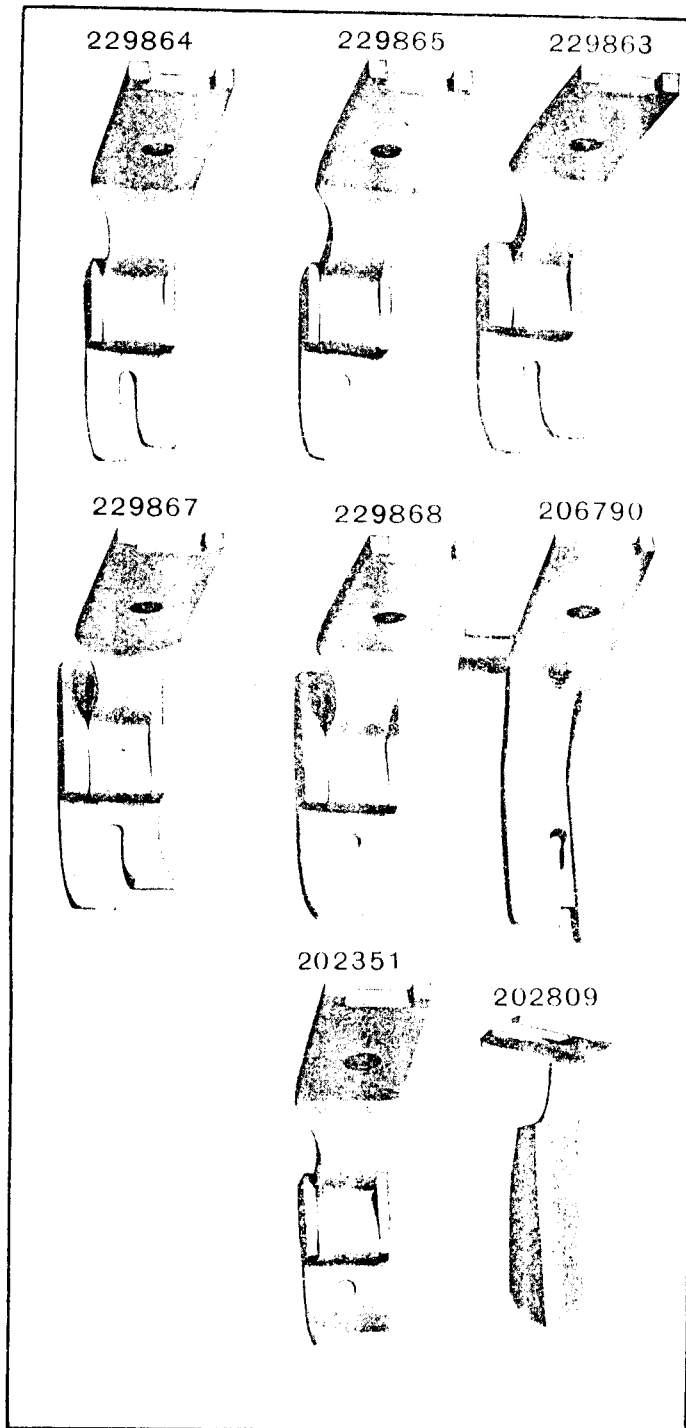


PLATE 10929 -FULL SIZE

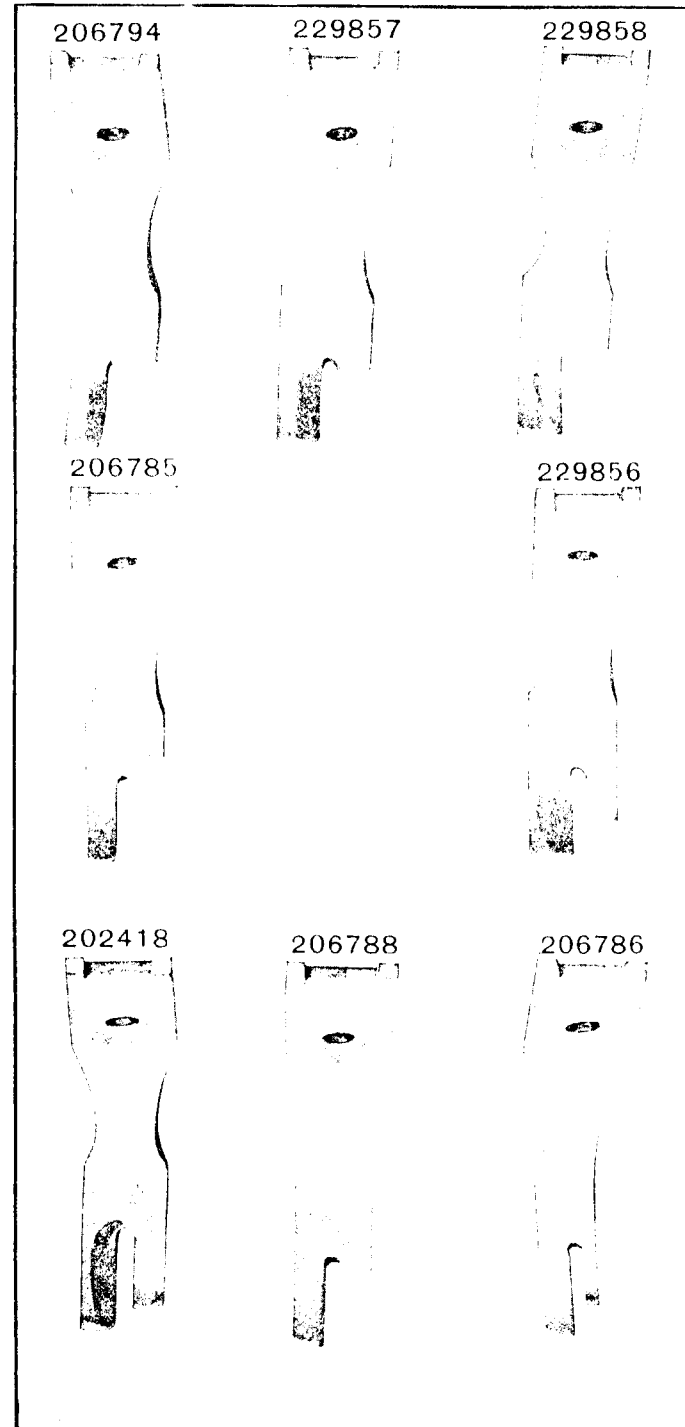


PLATE 11598—FULL SIZE

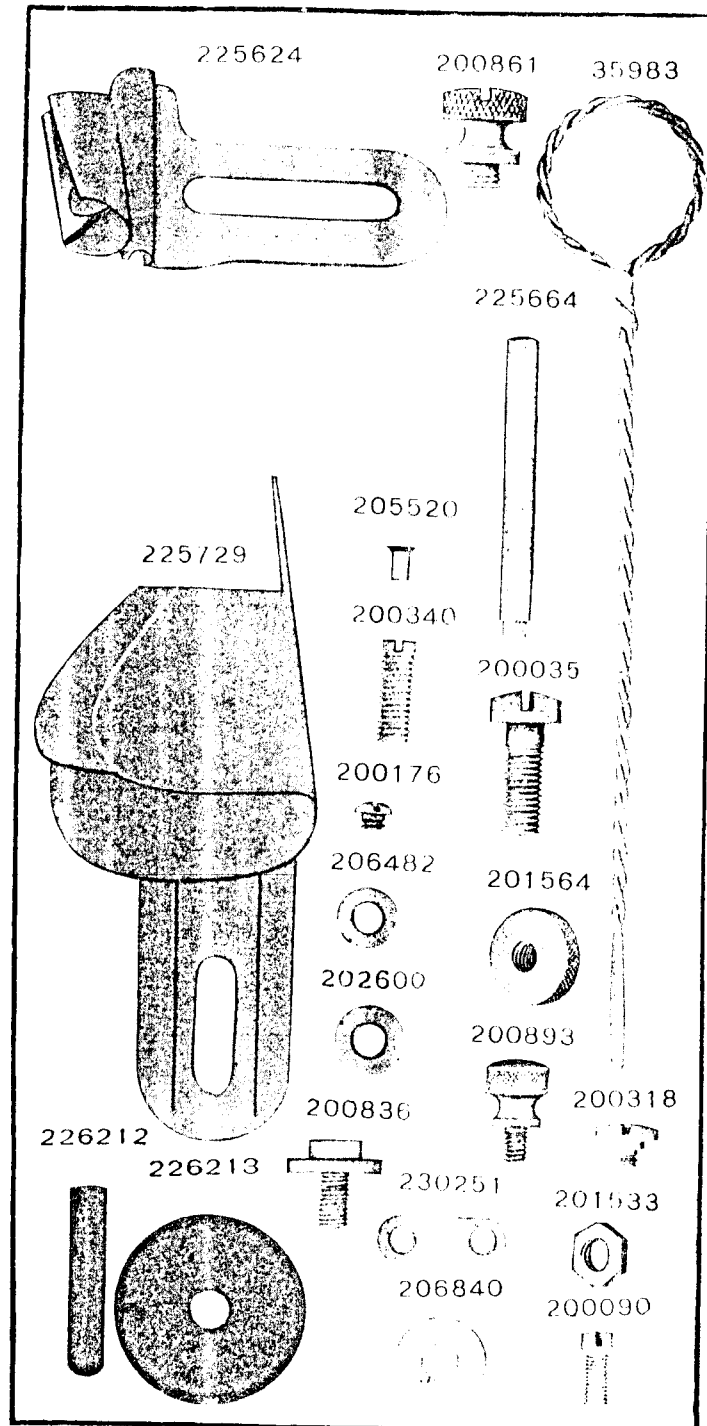


PLATE 11599—ONE-HALF SIZE

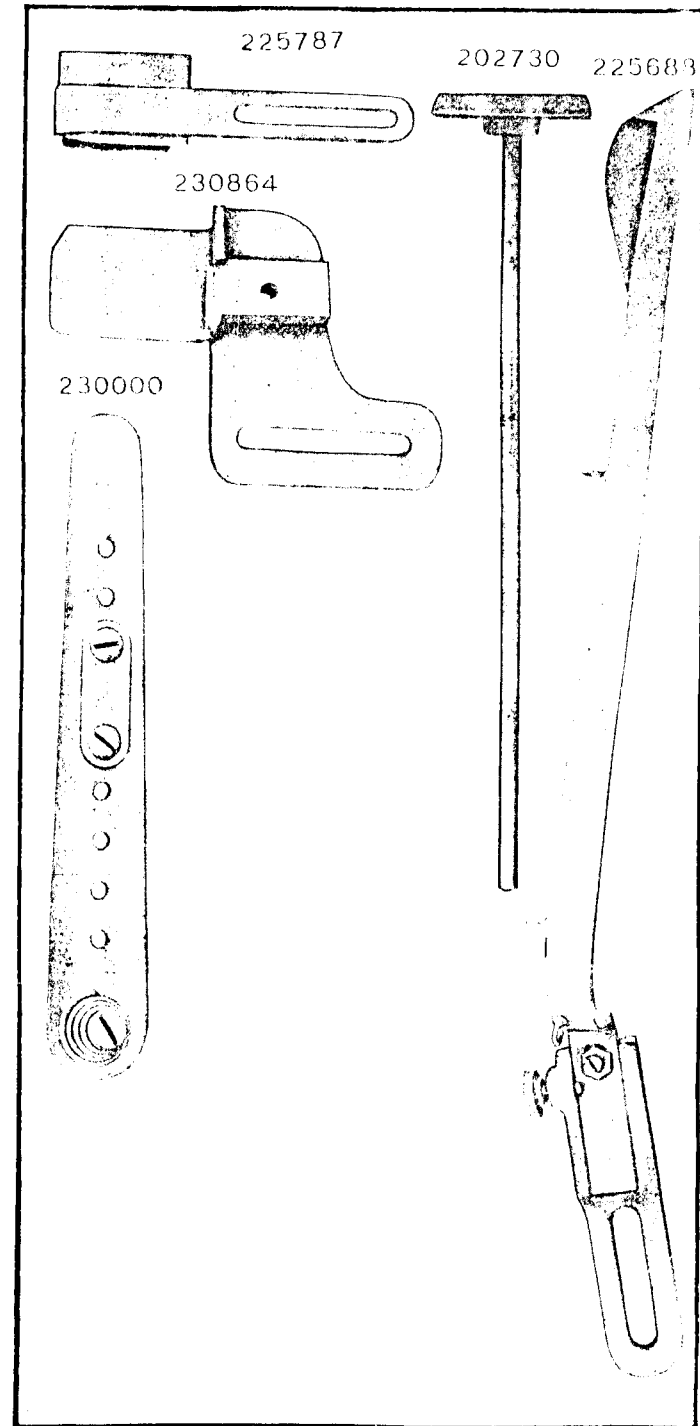


PLATE 11600-FULL SIZE

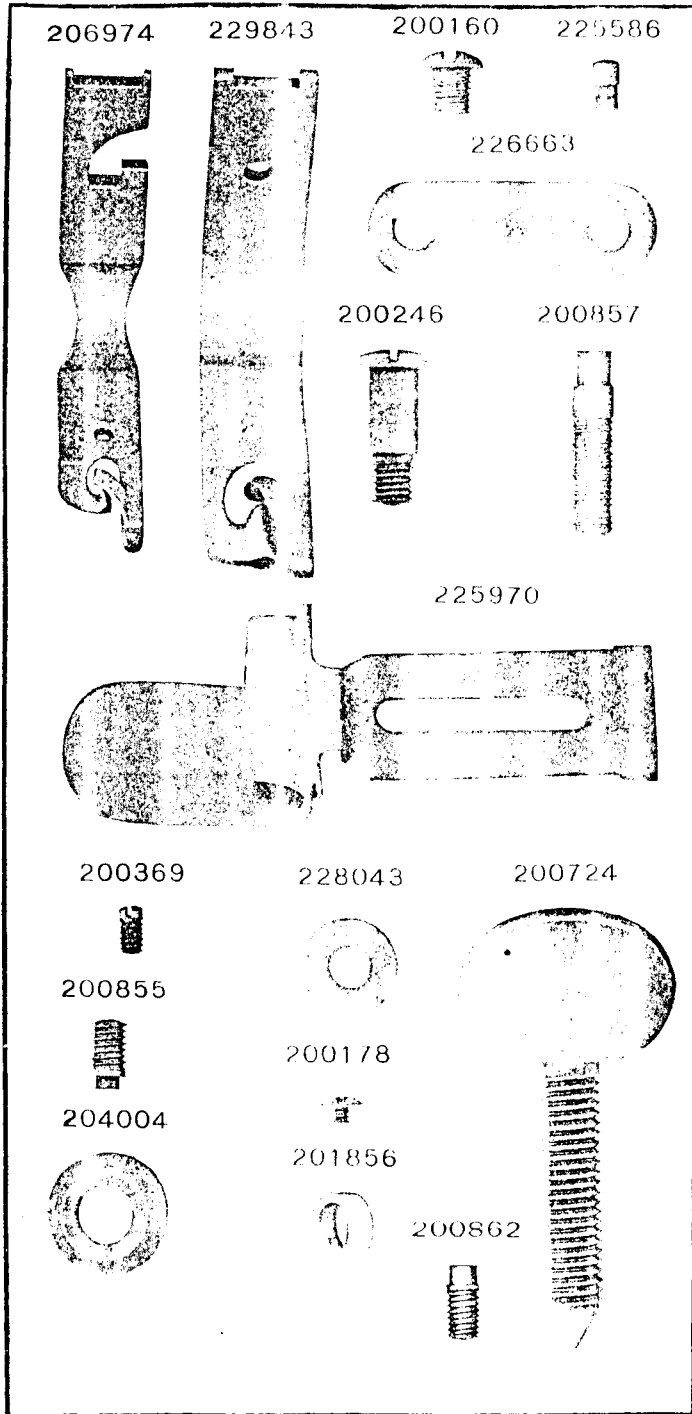


PLATE 11671-FULL SIZE

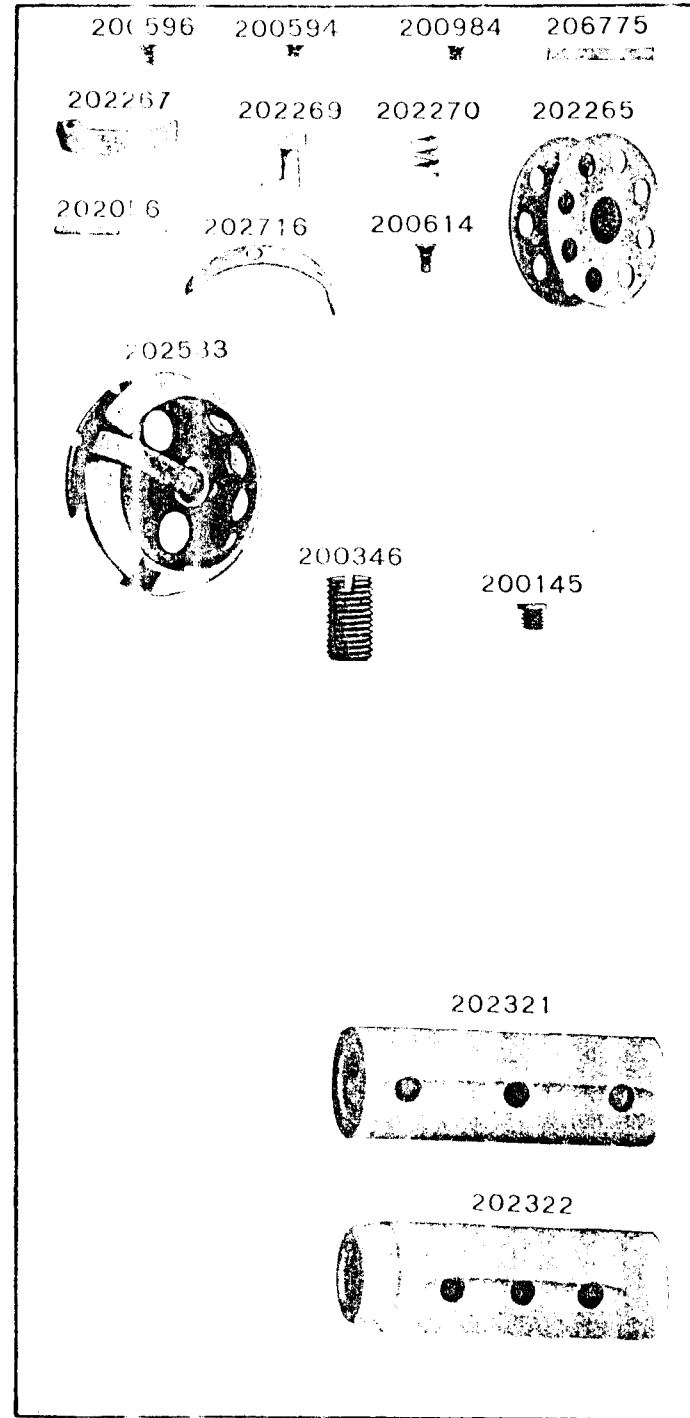


PLATE 12153-ONE-HALF SIZE

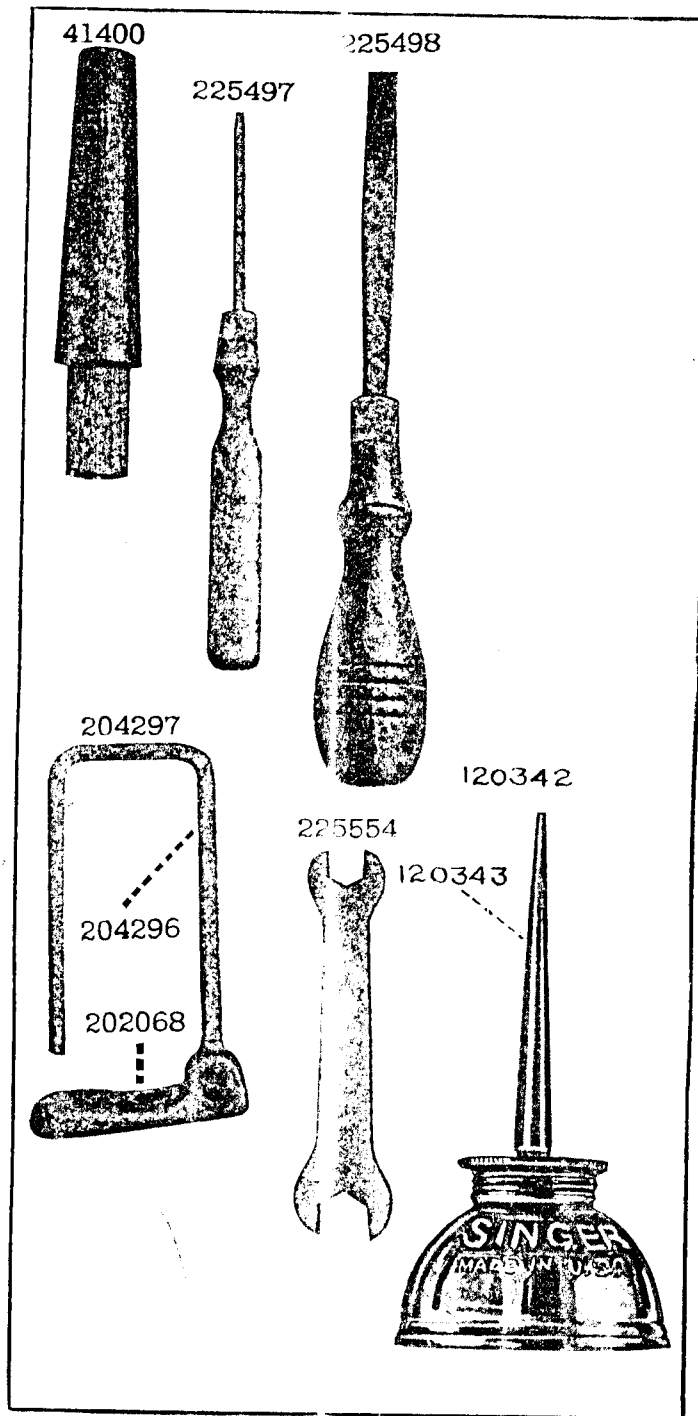


PLATE 13351-ONE-HALF SIZE

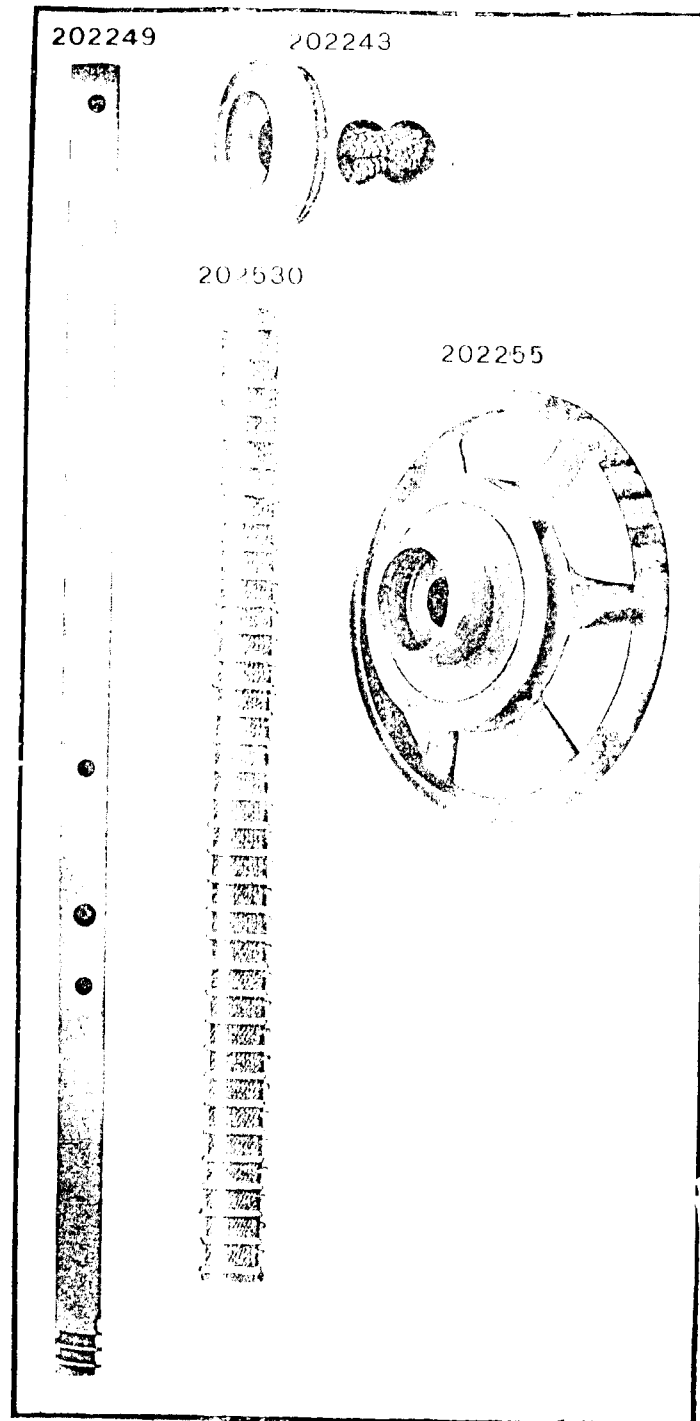
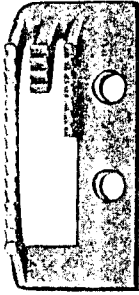
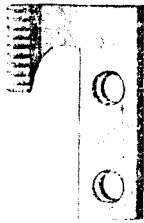


PLATE 13354 -FULL SIZE

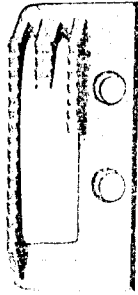
203136



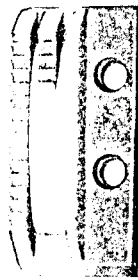
230625



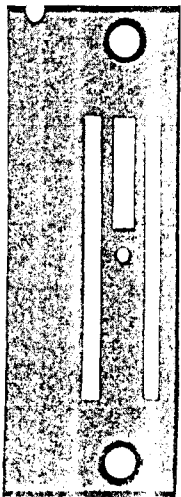
203173



203417



202818



202811



202828

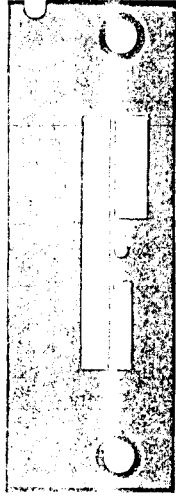


PLATE 13355 -FULL SIZE

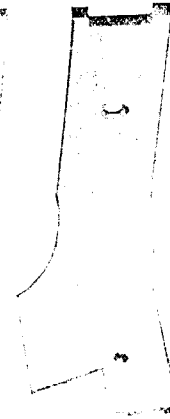
203198



203199



203200



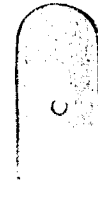
202373



206787



26608



231238

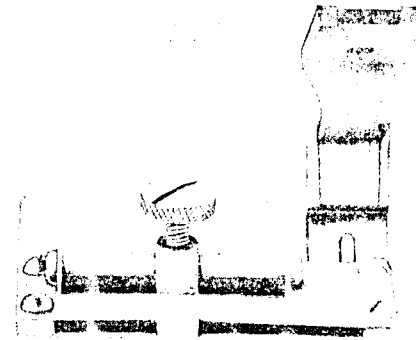


PLATE 13356-FULL SIZE

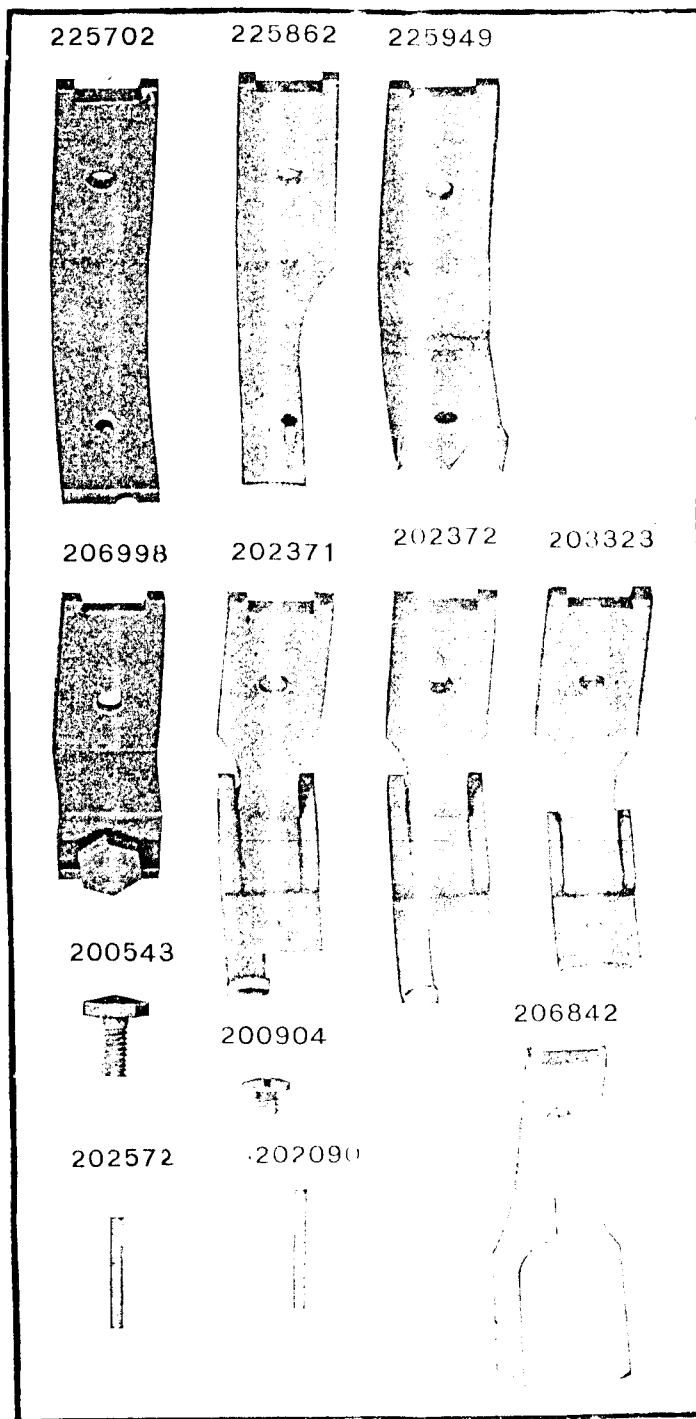


PLATE 13357-FULL SIZE

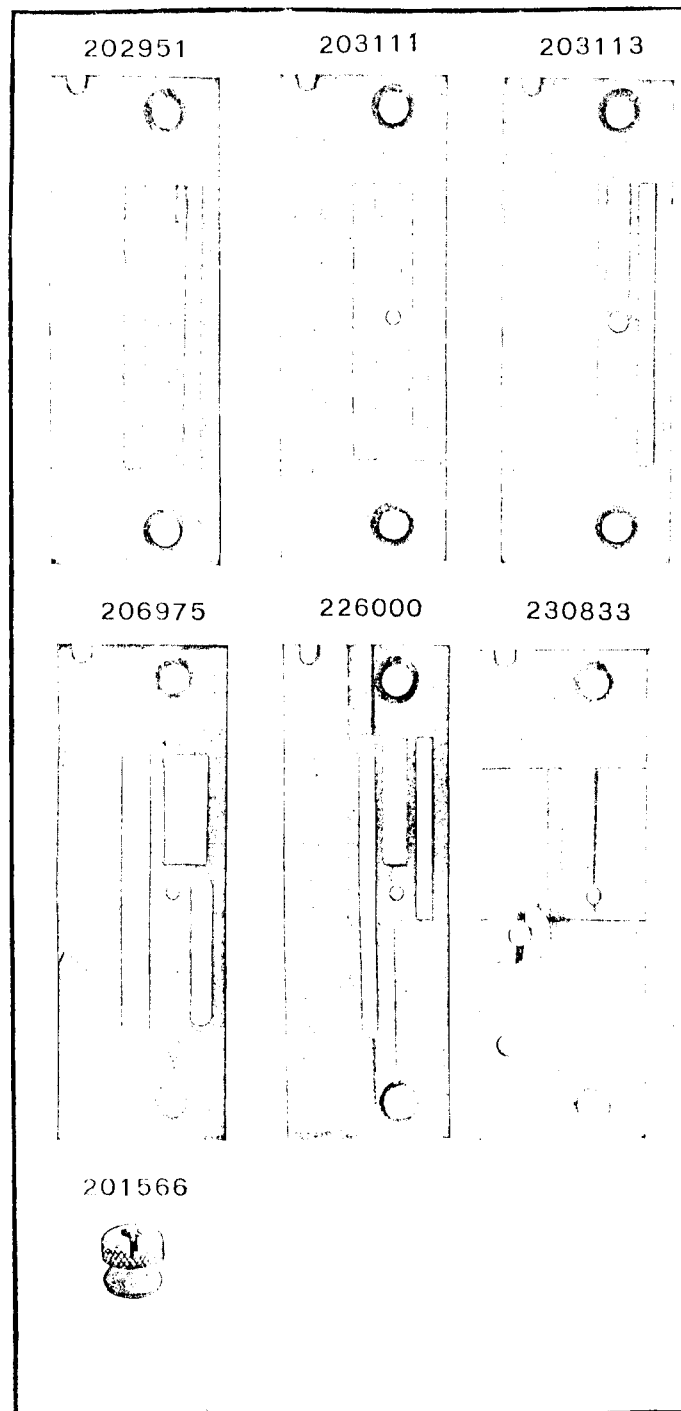
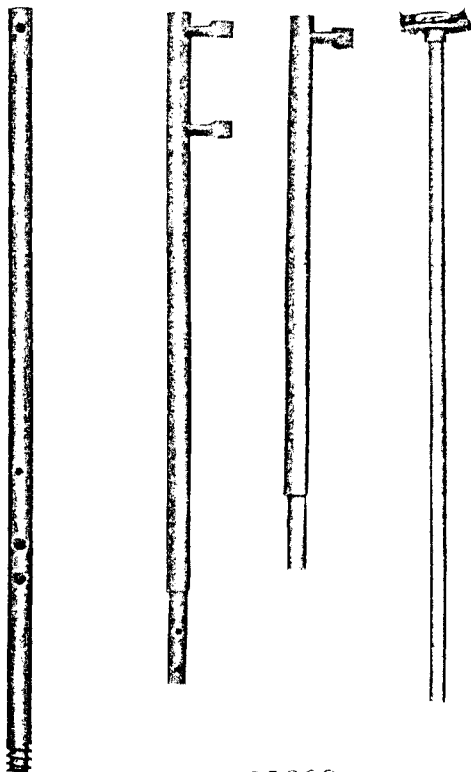
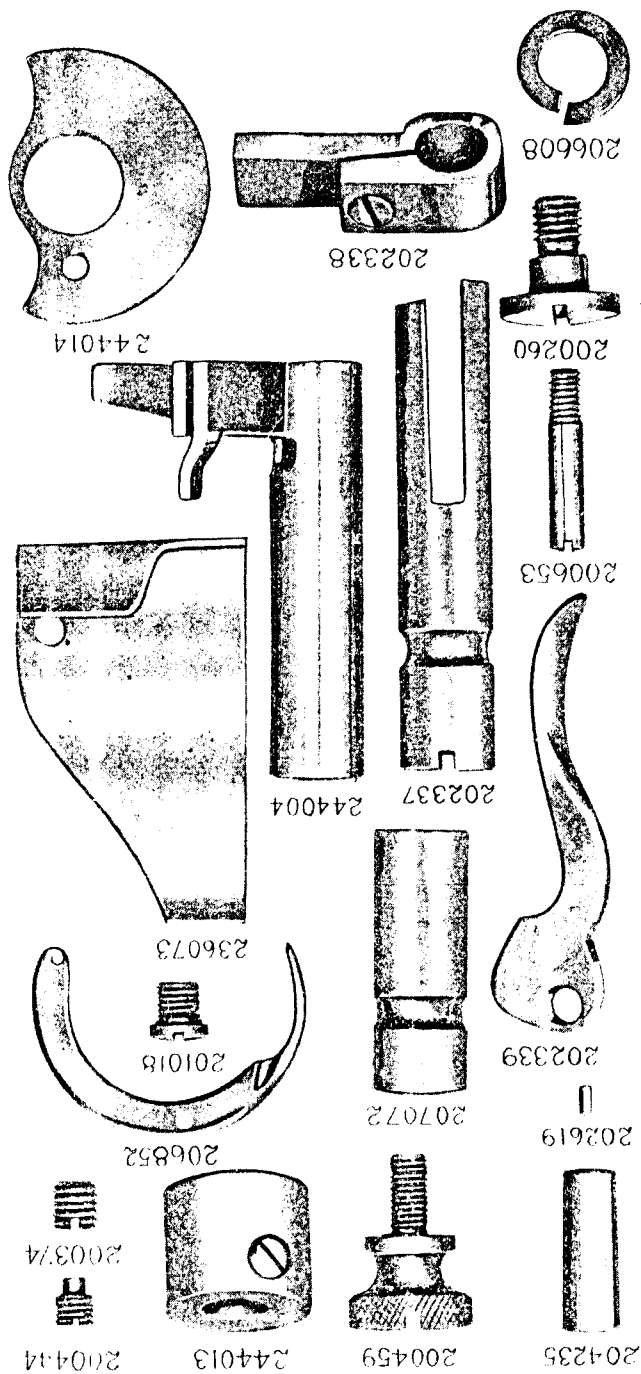
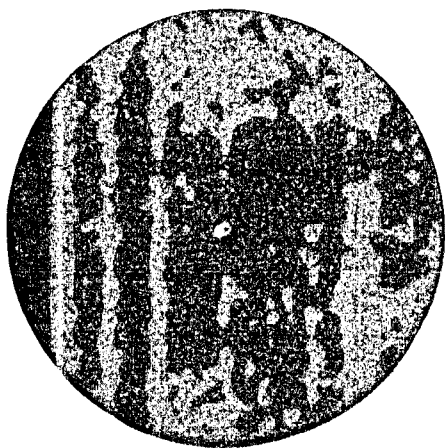


PLATE 13365-ONE-FOURTH SIZE

202250 202304 202654 206754



225663



204235 200459 244013 200414 202619 202339 207072 206852 201018 236073 202337 244004 200653 200260 202338 206608

PLATE 13875-FULL SIZE

PLATE 13376-ONE-HALF SIZE

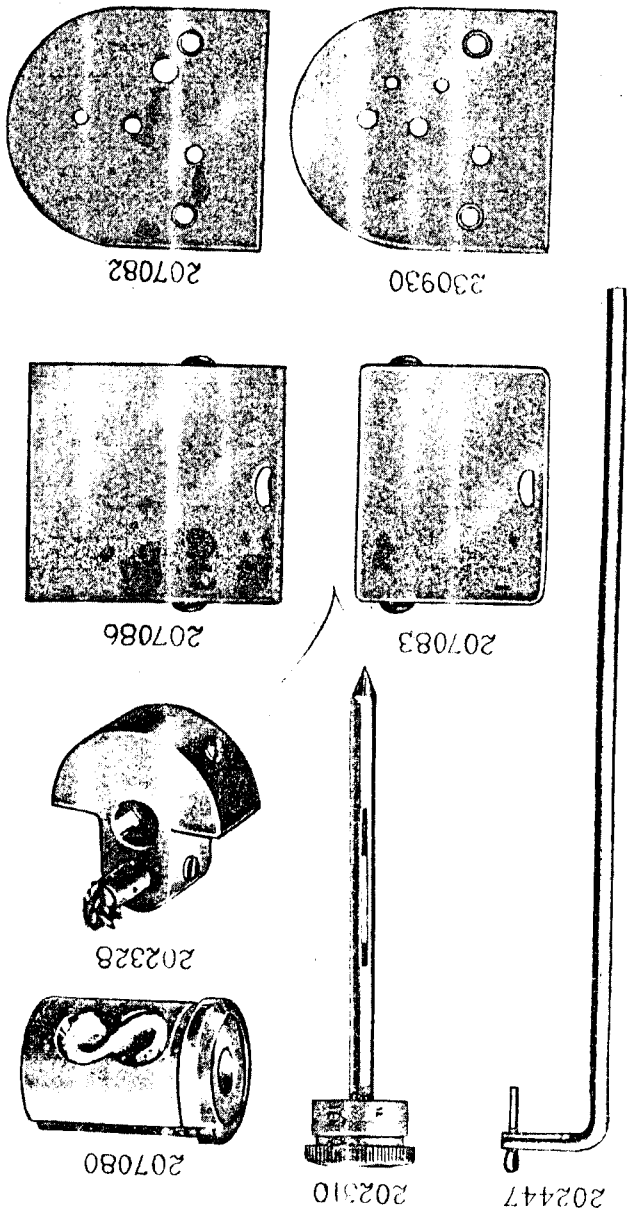
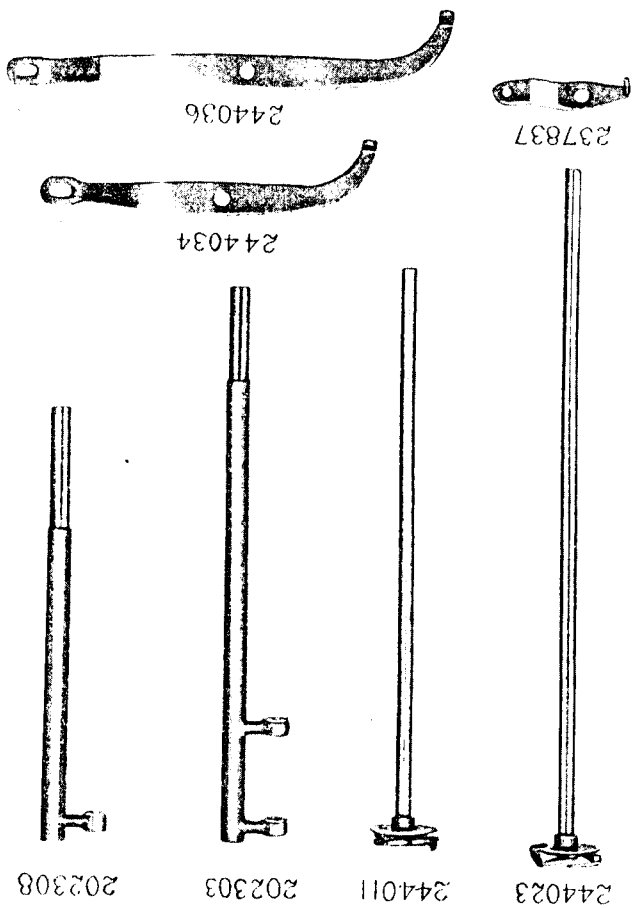


PLATE 13377-ONE-FOURTH SIZE



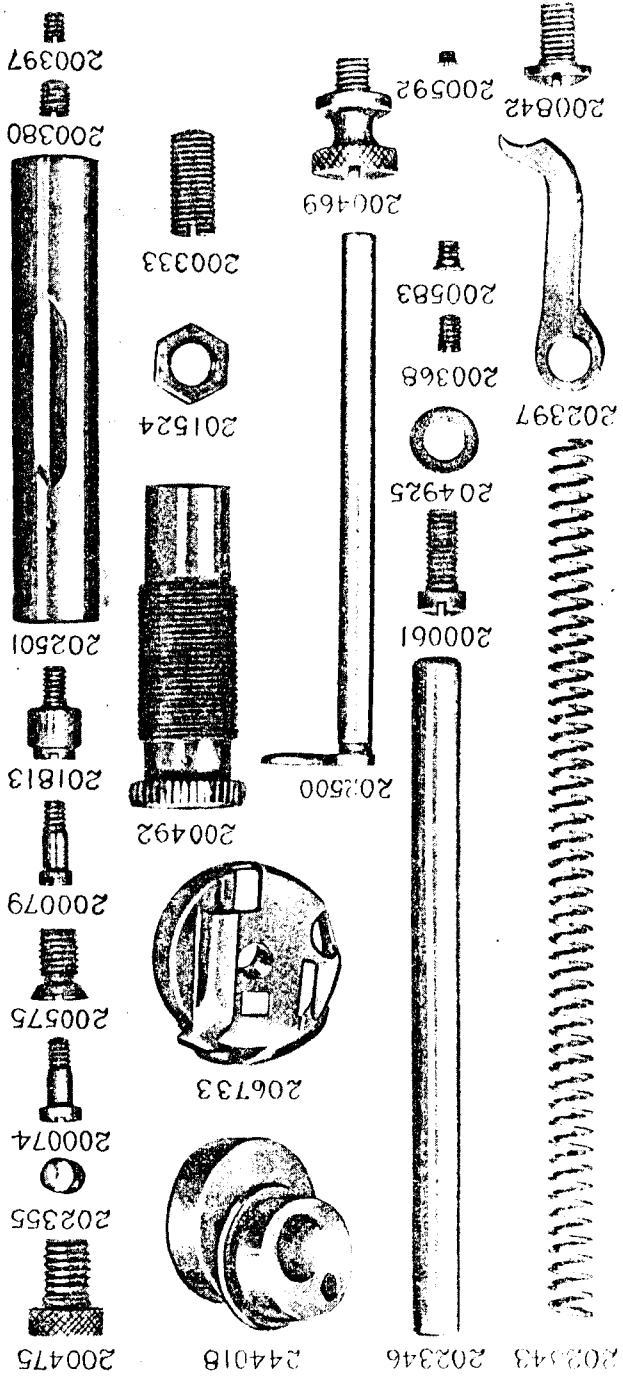


PLATE 13878-FULL SIZE

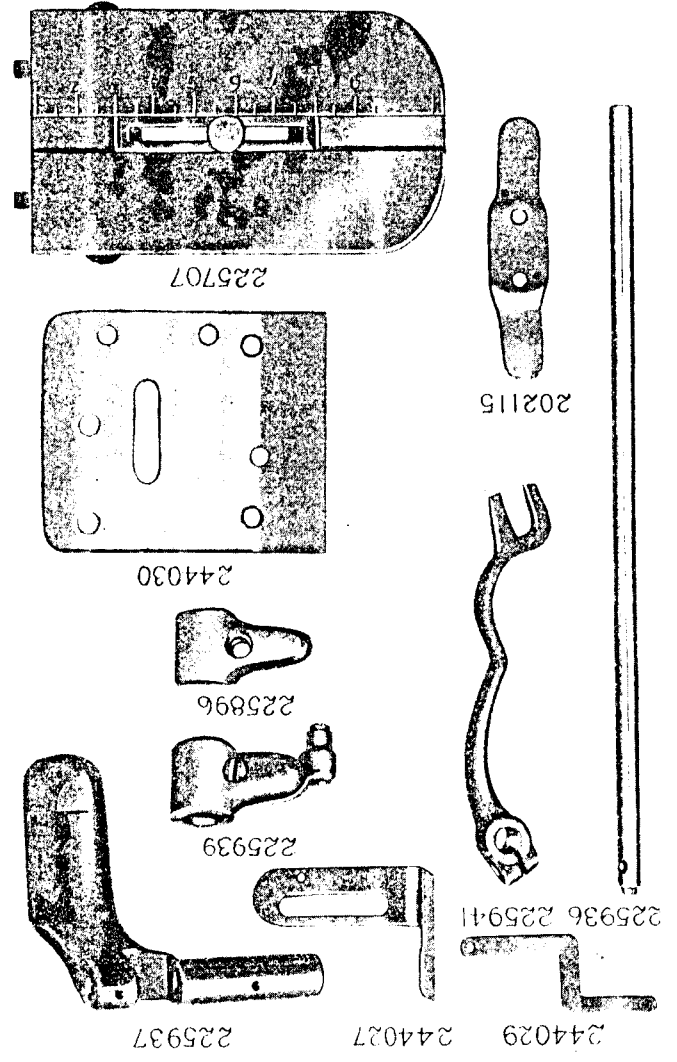
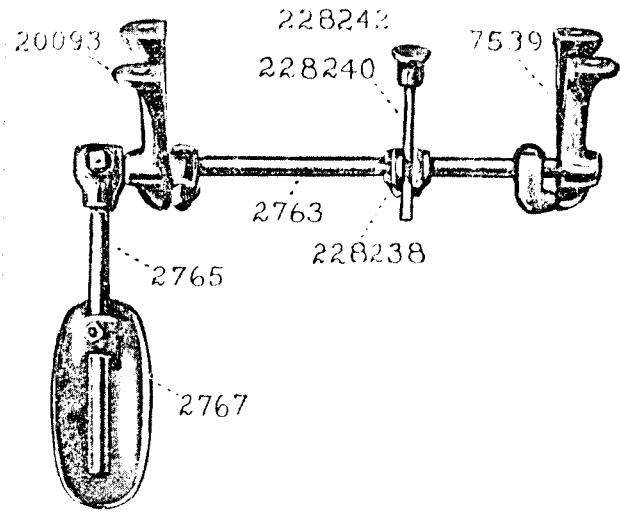


PLATE 13879-ONE-HALF SIZE

PLATE 14171—ONE-FOURTH SIZE



FULL SIZE

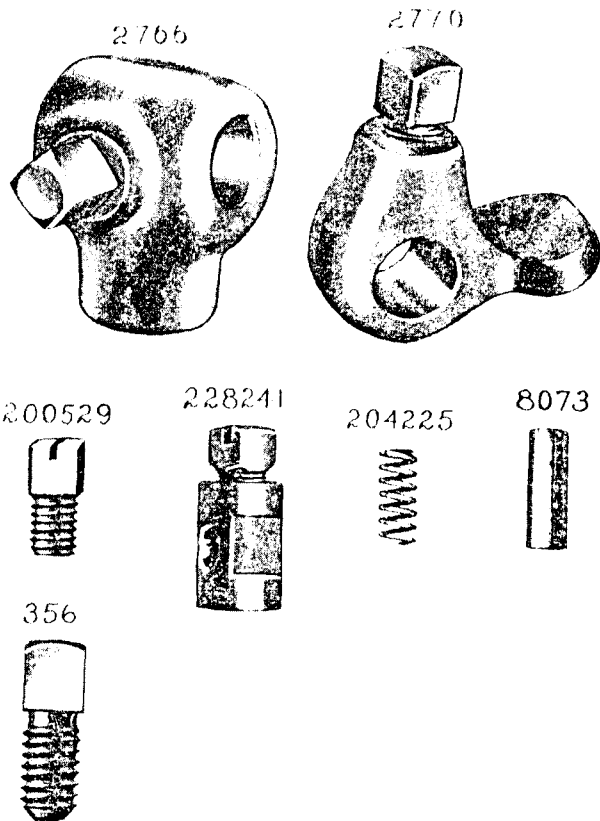


PLATE 13380—FULL SIZE

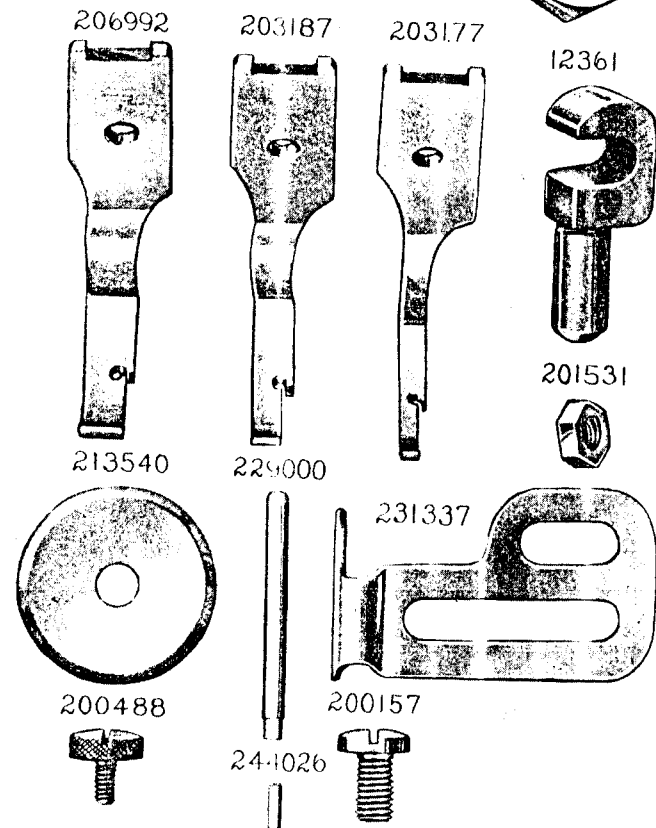
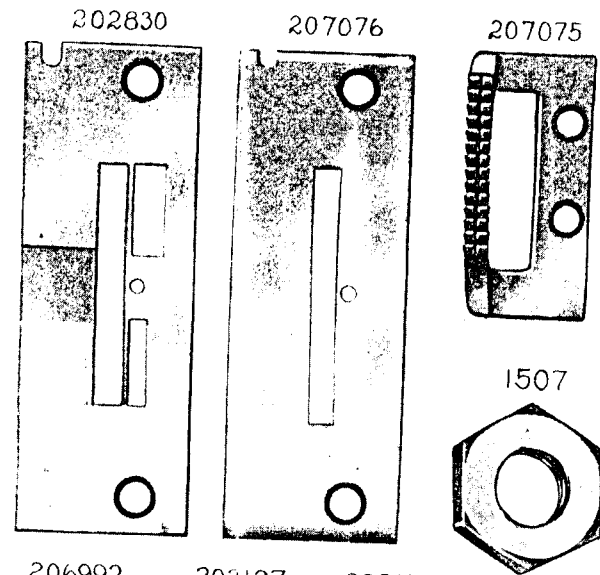
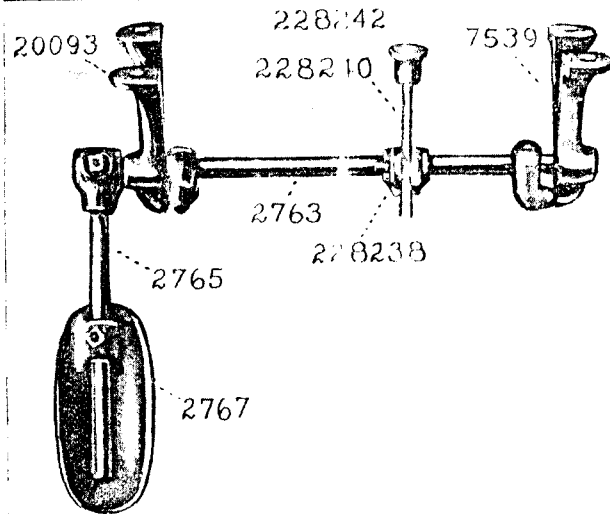


PLATE 14171—ONE-FOURTH SIZE



FULL SIZE

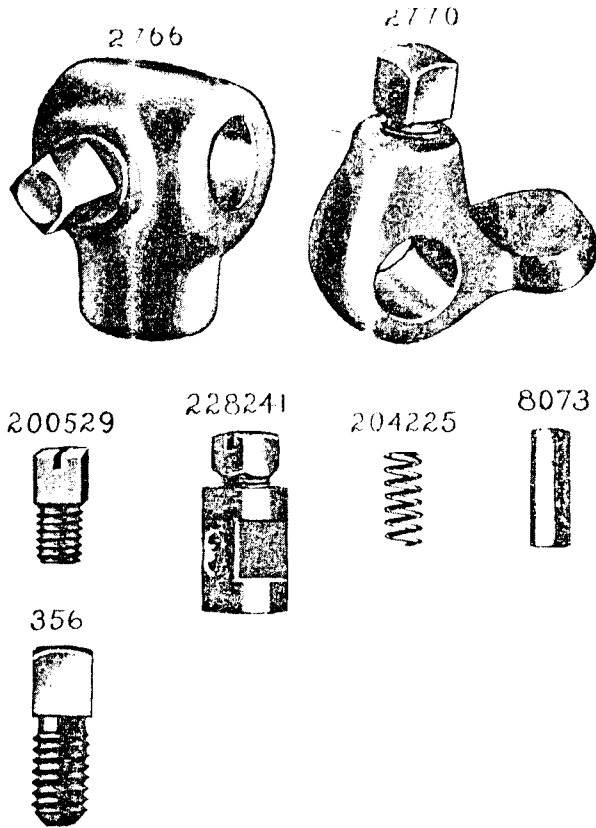


PLATE 14650—FULL SIZE

