

FORM 8573
DECEMBER, 1919

HISTORICAL COPY
DO NOT REMOVE

LIST
OF
PARTS



MACHINES
Nos. 62-55 to 62-57

** A TRADE MARK OF
THE SINGER MANUFACTURING COMPANY

INSTRUCTIONS FOR OILING

To ensure easy running and prevent unnecessary wear of the parts which are in movable contact, the machine requires oiling, and when in continuous use, "TYPE B" or "TYPE D" OIL, sold only by Singer Sewing Machine Company, should be applied at least twice each day to all oil holes marked "OIL", as instructed in Form 18024. "TYPE D" OIL is stainless.

COPYRIGHT, U. S. A., 1914, 1917 AND 1920

BY

THE SINGER MANUFACTURING CO.

ALL RIGHTS RESERVED FOR ALL COUNTRIES

INDEX

	PAGE
ATTACHMENTS AND ACCESSORIES	35
CUTTER GRINDER PARTS.....	35
EDGE GUIDE.....	35
FOOT LIFTER PARTS.....	36
KNEE LIFTER PARTS.....	37
KNIFE GRINDER PARTS.....	38
MACHINE BASE.....	34
MACHINE No. 62-55.....	7
" " 62-56.....	17
" " 62-57.....	26
NUMERICAL LIST OF PARTS.....	43
OBSOLETE PARTS.....	40
THREAD UNWINDERS.....	39

INSTRUCTIONS FOR ORDERING

In ordering from this list, use **ONLY** the part NUMBER in the **FIRST** column.

The number stamped on a Sewing Machine part is in every case the number of the single part only.

Every combination of parts sent out as such has its specific number, which, although not stamped on the parts, must be used when ordering the combination.

Each number always indicates the **SAME PART** in whatever list it appears, or for whatever machine.

The letters after some of the numbers indicate the style of finish only, as follows:

- A. Hardened, Polished and Plated.
- B. Polished and Plated
- C. Hardened only.
- D. Polished only.
- E. Soft, not Polished.
- F. Hardened and Polished.
- G.
- H. Blued.
- J. Plated only.
- K. Hardened and Plated.
- L. Brass or Gilt.
- M. Oxidized.
- P. Japanned.
- R. Parkerized.

These letters **MUST BE USED** when they appear in the list, and **AFTER** the number as in the list.

In this series

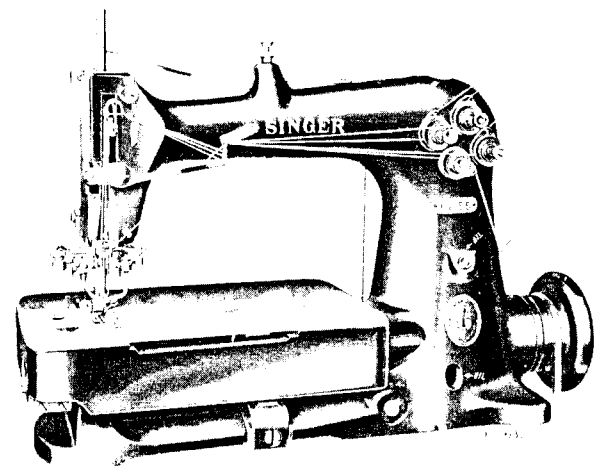
- 1 to 1500 and 50001 to 51500 are Screw Numbers.
- 1501 to 1800 are Nut Numbers.
- 1801 to 2000 are Roller Numbers.
- 2001 to 50000 and 52001 and upward are numbers of Machine Parts.

The figures in the second column refer only to the plates, illustrating the parts, and are **NOT TO BE USED** in ordering.

Parts marked with an asterisk (*) are furnished only when repairs are made at factory.

LIST OF PARTS COMPLETE

FOR



MACHINE No. 62-55

FOR JOINING CUFFS TO KNIT UNDERWEAR BEFORE CLOSING. THREE NEEDLES, ONE LOOPER, $\frac{3}{8}$ TO $\frac{1}{4}$ INCH (IN 32NDS) BETWEEN THE OUTSIDE NEEDLES. TRIPLE INTERLOCK STITCH, AUXILIARY FEED. BALANCE WHEEL 23873. DIAMETER OF BELT GROOVE $2\frac{1}{8}$ INCHES.

NO.	PLATE	NAME
*52988	—	Arm, upper and lower (solid) with 129c, 965b and 46445.....
52630	6608	Arm Oil Tube with 49092, for oiling 52990.....
49092	6608	Arm Oil Tube Packing (felt).....
46371	6587	“ Rock Shaft.....
46364	6588	“ “ “ Crank (back) with two 1497c.....

NO.	PLATE	NAME
1497c	6588	Arm Rock Shaft Crank (back) Set Screw.
52989	6588	" " " " (front) with 443c and 448c.
23724	6588	Arm Rock Shaft Crank (front) Pin.
443c	6588	" " " " " Set Screw.
46365	6589	" Rotary Shaft.
38329	6588	" " " Collar with two 457c.
457c	6588	" " " " " Set Screw.
23872	6490	" " " Flanged Bushing.
159F	6609	" " " " " Screw.
4784	6608	" " " Oil Pad (felt).
144d	6609	" " " Screw.
17509	6490	" Side Cover (lower).
286d	4875	" " " " Thumb Screw.
52829	6587	" " " (upper).
9533	6608	" " " Pin.
399F	6608	" " " " Screw.
23873	6589	Balance Wheel, 2 1/8 in. pulley, with two 430c.
430c	6610	Balance Wheel Set Screw.
52830	6590	Cloth Plate.
691F	6609	" " Screw (left).
1094F	6609	" " " (right).
52892	—	" " Slide (large).
52893	6591	Cloth Plate Slide (large) complete, Nos. 52892, two 38416 and four 725H.
38416	6500	Cloth Plate Slide (large) Spring.
725H	6500	" " " " " Screw.
52833	—	" " " (small).
52834	6591	Cloth Plate Slide (small) complete, Nos. 38419, 52833 and two 725H.
38419	6500	Cloth Plate Slide (small) Spring.
725H	6500	" " " " " Screw.
52894	—	Cloth Plate complete, Nos. 52830, 52834 and 52893.
52990	6587	Crank Connecting Rod with 46223, 52991 and two each 896E and 1057E.
50069c	6610	Crank Connecting Rod Ball Screw Stud
1619E	6610	" " " " " "
		Nut.
*52991	—	Crank Connecting Rod Cap (lower).
896E	6609	" " " " " Screw
*46223	—	" " " " (upper).
1057E	6609	" " " " " Screw
46225	6597	" " " Washer (fibre).
46179	6490	Face Plate.
46111	6608	" " Pin.

NO.	PLATE	NAME
286d	4875	Face Plate Thumb Screw.
38425	6190	Feed (back) Bar with 231c and 460c.
23716	6592	" " " Bushing.
23726	6592	" " " Hinge Pin.
231c	6592	" " " Set Screw.
38426	6592	" " " Slide Block.
38427	6190	" " Connecting Rod with 1057E, 23865 and two 896E.
*23865	—	Feed (back) Connecting Rod Cap.
896E	6609	" " " " " Screw.
23866	6592	" " " " Hinge Pin (eccentric).
46439	6592	Feed (back) Connecting Rod Hinge Pin Bushings.
178F	6609	Feed (back) Connecting Rod Hinge Pin Bushings Clamping Screw.
1057E	6609	Feed (back) Connecting Rod Hinge Pin Clamping Screw.
53168	6593	Feed (back) Dog.
157d	6609	" " " Screw.
460c	4875	" " " Stop Screw.
38429	6592	" " Lifting Eccentric with two 465c.
46113	6500	Feed (back) Lifting Eccentric Cover.
335d	6500	" " " " " Screw
465c	6592	" " " " " Set Screw.
52896	6594	" (front) Bar with 171d.
50109F	6610	" " " Hinge Screw.
52897	6591	" " Connecting Rod with two 174d.
174d	6609	Feed (front) Connecting Rod Adjusting Screw.
1131c	6610	Feed (front) Connecting Rod Hinge Screw
171d	6609	" " " " " " "
		Clamping Screw.
52898	6593	Feed (front) Dog.
52899	6592	" " " Holder.
52900	6592	" " " " Crank with 211F
211F	6592	" " " " " Clamping Screw.
52901	6592	Feed (front) Dog Holder Crank Connect- ing Link.
999F	6592	Feed (front) Dog Holder Crank Connect- ing Link Hinge Screw (lower).
999F	6592	Feed (front) Dog Holder Crank Connect- ing Link Hinge Screw (upper).
211c	6592	Feed (front) Dog Screw.

NO.	PLATE	NAME
52902	6594	Feed (front) Lifting Eccentric with two 448c.....
	448c 6610	Feed (front) Lifting Eccentric Set Screw.
52903	6587	" " " " Rock Shaft.....
*46445	—	" " " " " Bracket
129E	6609	" " " " " " Screw (back).....
965D	6609	Feed (front) Lifting Rock Shaft Bracket Screw (front).....
52904	6594	Feed (front) Lifting Rock Shaft Crank (back) forked, with 647D.....
647D	6609	Feed (front) Lifting Rock Shaft Crank (back) Clamping Screw.....
46447	6594	Feed (front) Lifting Rock Shaft Crank (back) Slide Block.....
52905	6594	Feed (front) Lifting Rock Shaft Crank (front) with two each 178D and 197D...
197D	6609	Feed (front) Lifting Rock Shaft Crank (front) Adjusting Screw.....
178D	6609	Feed (front) Lifting Rock Shaft Crank (front) Clamping Screw.....
50110c	6595	Feed (front) Regulating Stud.....
1701c	6595	" " " " Nut.....
46449	6595	" " " " Sleeve.....
*38127	—	" Eccentric.....
*52906	—	" " Body.....
443c	6595	" " " Set Screw.....
21331	6595	" " Pressure Spring.....
21332	6595	" " " Cap.....
934D	6595	" " " " Screw
196F	6595	" " Set Screw.....
217D	6595	" " Stop Screw.....
52907	6595	Feed Eccentric (adjustable) complete, Nos. 196F, 217D, 934D, 1103c, 21331, 21332, 38127, 52906 and two 443c.....
1103c	6595	Feed Regulating Screw.....
52908	6594	" Rocking Frame with 178E.....
38432	6594	" " " Bracket with two 465c.....
123E	6597	Feed Rocking Frame Bracket Screw.....
38433	6594	" " " Hinge Pin.....
465c	6592	" " " " " Set Screw
52844	6596	Looper with 590D and 52846.....
46145	6587	" Bell Crank with 1259c.....
38436	6490	" " " Hinge Stud.....
443c	6610	" " " " " Set Screw

NO.	PLATE	NAME
46314	6587	Looper Bell Crank Pitman complete, Nos. 1706E, 1713E and 46317 to 46319.....
50081c	6610	Looper Bell Crank Pitman Ball Screw Stud (upper).....
1518E	6610	Looper Bell Crank Pitman Ball Screw Stud (upper) Nut.....
46228	6596	Looper Bell Crank Pitman Ball Stud (lower).....
1259c	6610	Looper Bell Crank Pitman Ball Stud (lower) Set Screw.....
*46229	—	Looper Bell Crank Pitman Cap (lower)
171E	6609	" " " " " " Screw.....
*46230	—	Looper Bell Crank Pitman Cap (upper)
171E	6609	" " " " " " Screw.....
*46315	—	Looper Bell Crank Pitman End Bearing (lower).....
*46316	—	Looper Bell Crank Pitman End Bearing (upper).....
46317	6587	Looper Bell Crank Pitman Head (lower) Nos. 46228, 46229, 46315 and two 171E
46318	6587	Looper Bell Crank Pitman Head (upper) Nos. 46230, 46316, 50081c and two 171E
46319	6587	Looper Bell Crank Pitman Rod.....
1706E	6610	" " " " " Nut (lower).....
1713E	6610	Looper Bell Crank Pitman Rod Nut (upper).....
46244	6601	Looper Bell Crank Pitman Washer (fibre)
38439	6596	" Carrier with 1143c and two 1147c
38440	6596	" " Hinge Pin.....
1147c	6596	" " " " Set Screw.....
46367	6587	Looper Carrier Pitman complete, Nos. 1708E, 1709E, 46176, 46241 and 46242.
50070c	6610	Looper Carrier Pitman Ball Screw Stud (right).....
1636E	6610	Looper Carrier Pitman Ball Screw Stud (right) Nut.....
46237	6596	Looper Carrier Pitman Ball Stud (left)
1147c	6596	" " " " " " Set Screw.....
*46238	—	Looper Carrier Pitman Cap (left).....
171E	6609	" " " " " Screw..
*46238	—	" " " " (right).....
171E	6609	" " " " " Screw.
*46239	—	" " " " End Bearing (left)

NO.	PLATE	NAME
*46240	—	Looper Carrier Pitman End Bearing(right)
46241	6587	" " " Head (left) Nos. 46237 to 46239 and two 171E.....
46242	6587	Looper Carrier Pitman Head (right) Nos. 46238, 46240, 50070c and two 171E....
46176	6587	Looper Carrier Pitman Rod.....
1708E	6610	" " " " Nut (left)...
1709E	6610	" " " " " (right)...
46244	6601	" " " Washer (fibre)...
53012	6596	" " Rock Shaft with two 175D
175D	6596	" " " Adjusting Screw.....
53013	6596	Looper Carrier Rock Shaft Crank (forked) with 159E.....
159E	6596	Looper Carrier Rock Shaft Crank Clamp- ing Screw.....
38451	6596	Looper Carrier Rock Shaft Crank Slide Block.....
46043	6596	Looper Carrier Rock Shaft Hinge Pin....
1508E	6596	" " " " " " Nut
129E	6609	" " " " " " Set Screw.....
38452	6596	Looper Eccentric with two 465c.....
465c	6596	" " Set Screw.....
52845	6596	" Needle Guard with 46105.....
46105	6596	" " " Pin.....
229D	6596	" " " Screw.....
1143c	6596	" Set Screw.....
38453	6597	" Shaft.....
52553	6597	" " Bracket.....
123E	6597	" " " Screw.....
391D	6597	" " " Screw.....
52846	6596	" Thread Guard.....
590D	6596	" " " Screw.....
46051	6598	Needle Bar.....
38456	6597	" " Bushing.....
1133E	6597	" " " Set Screw.....
46205	6597	" " Connecting Link.....
52992	6597	" " " " Hinge Stud
1520E	6597	" " " " " " "
		Nut.....
46206	6597	Needle Bar Connecting Stud with two 391E.....
391E	6597	Needle Bar Connecting Stud Clamping Screw.....
52911	6597	Needle Clamp with three 904E.....
52912	6597	" " Thread Retainer.....

NO.	PLATE	NAME
1447E	6597	Needle Clamp Thread Retainer Screw...
54716	6597	" " " " Spring...
904E	6597	" Set Screw.....
52850	6598	Presser Bar.....
46338	6597	" " Bushing Lower.....
1133E	6597	" " " " Set Screw.....
38456	6597	" " " " Upper.....
1133E	6597	" " " " Set Screw.....
52851	6595	" " Lifter.....
17542	6595	" " " Hinge Pin.....
52852	6595	" " Lifting Bracket with 195D, 453c, 892c and 52853.....
892c	6595	Presser Bar Lifting Bracket Adjusting Screw.....
52853	6595	Presser Bar Lifting Bracket Extension
195D	6595	" " " " " "
		Screw.....
453c	6595	Presser Bar Lifting Bracket Set Screw...
38467	6587	" " Spring (flat).....
38468	6608	" " " Stud.....
26276	6608	" Foot Hinge Pin.....
53169	—	" " Plate.....
46087	—	" " Shank.....
53170	6593	Presser Foot (hinged) complete, Nos. 26276, 46087 and 53169.....
190D	6500	Presser Foot Screw.....
574D	6536	Pressure Regulating Thumb Screw.....
1539D	6610	" " " " Lock Nut.....
46034	6599	Slack Thread Controller.....
46035	6599	" " " Clamp.....
190D	6599	" " " " Screw...
52994	6599	" " Regulator.....
52569	6599	" " " Bracket with 704c and 1823.....
704c	6599	Slack Thread Regulator Bracket Clamp- ing Screw.....
38474	6599	Slack Thread Regulator Bushing.....
1823	6599	" " " Roller and Stud.
50062D	6599	" " " Screw.....
1620E	6599	" " " " Nut.....
52859	6600	Spreader.....
52995	6600	" Holder with 857H and 1253c...
52861	6600	" " Hinge Stud.....
1253c	6600	" " " Set Screw...
52862	6602	Spreader Pitman complete, Nos. 1550H, 1682E and 52868 to 52870.....

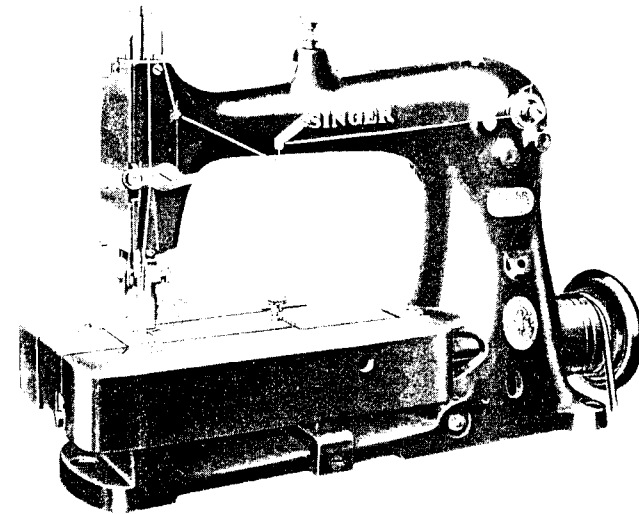
NO.	PLATE	NAME
52863	6600	Spreader Pitman Ball Stud (front).....
1253c	6600	" " " " " " " " S e t Screw.....
*52864	—	Spreader Pitman Cap (back).....
208E	6600	" " " " " " " " Screw.....
*52865	—	" " " " (front).....
208E	6600	" " " " " " " " Screw.....
*52866	—	" " " " End Bearing (back)....
*52867	—	" " " " " " (front)....
52868	6602	" " " " Head (back) Nos. 52864, 52866 and two 208E.....
52869	6602	Spreader Pitman Head (front) Nos. 52863, 52865, 52867 and two 208E.....
52870	6602	Spreader Pitman Rod.....
1682E	6600	" " " " Nut (back).....
1550H	6600	" " " " " " (front).....
857H	6600	" " " " Set Screw.....
2102	6601	Tension (thread carrier) Disc.....
1560c	6601	" " " " R e g u l a t i n g Thumb Nut.....
916F	6601	Tension (thread carrier) Screw Stud.....
10148	6601	" " " " Spring.....
17547	6601	" " " " Thread Guide....
2102	6601	" " (under thread) Disc.....
1560c	6601	" " " " R e g u l a t i n g Thumb Nut.....
916F	6601	Tension (under thread) Screw Stud.....
10148	6601	" " " " Spring.....
17547	6601	" " " " Thread Guide....
2102	6601	" " (upper thread) Disc.....
1560c	6601	" " " " R e g u l a t i n g Thumb Nut.....
50148F	6601	Tension (upper thread) Screw Stud.....
54883	6601	" " " " Spring.....
17547	6601	" " " " Thread Guide....
52871	6600	Thread Carrier.....
52996	6602	" " " " Bell Crank with three 462c
52997	6602	" " " " " " Bracket.....
177c	6602	" " " " " " " " Screw
52874	6602	" " " " " " Connection
52875	6602	" " " " " " " "
		Hinge Stud (lower).....
462c	6602	Thread Carrier Bell Crank Connection Hinge Stud (lower) Set Screw.....
52876	6602	Thread Carrier Bell Crank Connection Hinge Stud (upper).....

NO.	PLATE	NAME
448c	6602	Thread Carrier Bell Crank Connection Hinge Stud (upper) Set Screw.....
52877	6602	Thread Carrier Bell Crank Hinge Stud...
462c	6602	" " " " " " " " Set
52878	6602	Thread Carrier Bell Crank Hinge Stud
52879	6600	Thread Carrier Holder Bracket with four 1253c.....
	1253c	6600 Thread Carrier Holder Bracket Set Screw
52861	6600	" " " " Hinge Stud.....
	1253c	6600 " " " " " " " " Set Screw.....
52862	6602	Thread Carrier Pitman complete, Nos. 1550H, 1682E and 52868 to 52870.....
52880	6602	Thread Carrier Pitman Ball Stud (back, double).....
52881	—	Thread Carrier Pitman Ball Stud (back, double) 52880 with two 52862.....
	462c	6610 Thread Carrier Pitman Ball Stud (back) Set Screw.....
52863	6600	Thread Carrier Pitman Ball Stud (front)
	1253c	6600 " " " " " " " "
		Set Screw.....
*52864	—	Thread Carrier Pitman Cap (back).....
	208E	6600 " " " " " " " " Screw.
*52865	—	" " " " " " (front).....
	208E	6600 " " " " " " " " Screw.
*52866	—	" " " " " " E n d B e a r i n g (back).....
*52867	—	Thread Carrier Pitman End Bearing (front).....
52868	6602	Thread Carrier Pitman Head (back) Nos. 52864, 52866 and two 208E.....
52869	6602	Thread Carrier Pitman Head (front) Nos 52863, 52865, 52867 and two 208E.....
52870	6602	Thread Carrier Pitman Rod.....
	1682E	6600 " " " " " " Nut (back)...
	1550H	6600 " " " " " " " " (front)...
	857H	6600 " " " " " " Set Screw.....
38022	6600	" " " " Thread Eyelet (back of arm).....
	207D	6600 Thread Carrier Thread Eyelet (back of arm) Screw.....
18172	6600	Thread Carrier Thread Eyelet (side of arm).....
38225	6497	Thread (under) Eyelet (back).....

NO.	PLATE	NAME
190D	6497	Thread (under) Eyelet (back) Screw.....
38284	6497	“ “ “ (front).....
46049	6497	“ “ Nipper Cam with 465c... ..
465c	6497	“ “ “ “ Set Screw... ..
38210	6497	“ “ “ Spring (lower)... ..
38211	6497	“ “ “ “ (upper)... ..
46247	6497	“ “ “ “ “ Stop
176D	6497	“ “ “ “ Screw.....
53171	6599	“ “ Take-up with 465c.....
465c	6599	“ “ “ Set Screw.....
46211	6599	“ “ “ Staple.....
46040	6594	“ “ “ “ Bracket
		with 910c.....
690D	6609	Thread (under) Take-up Staple Bracket
		Screw.....
46041	6497	Thread (under) Take-up Staple Spring
190D	6497	“ “ “ “ “
		Screw.....
910c	6497	Thread (under) Take-up Staple Stop
		Screw.....
53172	6599	Thread (under) Take-up Stripper.....
207D	6599	“ “ “ “ Screw..
38476	6497	“ “ “ Thread Guard
		(left).....
207D	6497	Thread (under) Take-up Thread Guard
		(left) Screw.....
38477	6497	Thread (under) Take-up Thread Guard
		(right).....
207D	6497	Thread (under) Take-up Thread Guard
		(right) Screw.....
52920	6608	Thread (upper) Controller.....
228D	6608	“ “ “ Screw.....
52921	6608	“ “ “ Eyelet.....
190D	6608	“ “ “ Screw.....
139E	6608	“ “ Separating Screw.....
52923	6608	“ “ Take-up.....
228D	6608	“ “ “ Adjusting Serew.
53173	6593	Throat Plate for 52898 and 53168.....
691F	6609	“ “ “ Screw.....

LIST OF PARTS COMPLETE

FOR



MACHINE No. 62-56

FOR TRIMMING AND STITCHING KNIT GOODS AND OTHER FABRICS.
 ONE NEEDLE, ONE LOOPER. HAS AUXILIARY FEED MECHAN-
 ISM AND VERTICAL TRIMMER THAT TRIMS BY COMPRESSION,
 ADJUSTABLE TO TRIM FROM $\frac{3}{8}$ TO $\frac{3}{16}$ INCH FROM THE NEEDLE.
 THE CUTTING MEMBERS ARE ACTUATED BY AN ECCENTRIC ON
 THE ROTARY SHAFT. BALANCE WHEEL NO. 23873. DIAMETER
 OF BELT GROOVE $2\frac{1}{8}$ INCHES.

NO.	PLATE	NAME	EACH
*52944	—	Arm, upper and lower (solid) with 129E, 965D and 46445.....	
52630	6608	Arm Oil Tube with 49092, for oiling 46221	
49092	6608	“ “ “ Packing (felt).....	
46216	6490	“ Rock Shaft.....	
46217	6588	“ “ “ Crank (back) with two 1497c.....	

NO.	PLATE	NAME
1497c	6588	Arm Rock Shaft Crank (back) Set Screw.
38412	6588	" " " " (front) with 443c.
23724	6588	" " " " " Pin.....
443c	6588	" " " " " Set Screw.
52945	6589	" Rotary Shaft.....
38329	6588	" " " Collar with two 457c..
457c	6588	" " " " Set Screw.....
23872	6490	" " " Flanged Bushing.....
159F	6609	" " " " " Screw
4784	6608	" " " Oil Pad (felt).....
144d	6609	" " " Screw.....
17509	6490	" Side Cover (lower).....
286d	4875	" " " " Thumb Screw...
52554	6490	" " " (upper).....
9533	6608	" " " " Pin.....
176d	6497	" " " " Screw.....
23873	6589	Balance Wheel, 2½ in. pulley, with two 430c.....
430c	6610	Balance Wheel Set Screw.....
52946	6590	Cloth Plate.....
691F	6609	" " Screw (left).....
1094F	6609	" " " (right).....
52947H	—	" " Slide (left).....
52948	6591	Cloth Plate Slide (left) complete, Nos. 38419, 52947H and two 725H.....
38419	6500	Cloth Plate Slide (left) Spring.....
725H	6500	" " " " " Screw.....
52631H	6591	" " " (right) with 1602H.....
1602H	6610	" " " " Bushing.....
286d	4875	" " " " Thumb Screw...
52949	—	Cloth Plate complete, Nos. 286d, 52631H, 52946 and 52948.....
46221	6490	Crank Connecting Rod with 46222, 46223 and two each 896E and 1057E.....
50069c	6610	Crank Connecting Rod Ball Screw Stud
1619E	6610	" " " " " " "
		Nut.....
*46222	—	Crank Connecting Rod Cap (lower).....
896E	6609	" " " " " Screw
*46223	—	" " " " (upper).....
1057E	6609	" " " " " Screw
46225	6597	" " " Washer (fibre)....
52780	66 33	Cutting Lever.....
52950	6603	" " Adjusting Slide.....
190d	6603	" " " " Screw.....
1389F	6603	" " " Screw.....
46327	6603	" " Cap.....

NO.	PLATE	NAME
207F	6603	Cutting Lever Cap Screw.....
52951	6603	" " Connecting Link.....
50114d	6603	" " " " Hinge Screw (lower).....
1247d	6603	Cutting Lever Connecting Link Hinge Screw (upper).....
52952	6604	Cutting Lever Eccentric with two 457c..
52953	6604	" " " Connection.....
1042c	6604	" " " " Hinge Screw.....
1547d	6604	Cutting Lever Eccentric Connection Hinge Screw Nut.....
52954	6604	Cutting Lever Eccentric Connection Lever
52955	6604	" " " " " "
		Bracket.....
134d	6604	Cutting Lever Eccentric Connection Lever Bracket Screw.....
788d	6604	Cutting Lever Eccentric Connection Lever Hinge Screw.....
457c	6604	Cutting Lever Eccentric Set Screw.....
1247c	6603	" " Hinge Screw.....
53122	6603	" Plate.....
1246c	6603	" " Adjusting Screw.....
1643d	6603	" " " " T h u m b Nut.....
38152	6603	Cutting Plate Adjusting Slide.....
207F	6603	" " " " Screw.....
52956	6603	" " Bracket.....
52957	6604	" " " Holder.....
690d	6604	" " " " Adjusting Screw.....
186d	6603	Cutting Plate Bracket Screw (lower)....
190d	6603	" " " " (upper)....
38155	6603	" " Friction Plate.....
1247c	6603	" " " " Screw.....
87F	6603	" " Hinge Screw.....
52958	—	Cutting Plate Bracket complete, Nos. 87F, 1246c, 1389F, 1643d, 38152, 38155, 46327, 52780, 52950, 52956, 52957, 53122, two each 186d, 190d, 1247c and four 207F.....
46179	6490	Face Plate.....
46111	6608	" " Pin.....
286d	4875	" " Thumb Screw.....
52959	6592	Feed (back) Bar with 231c.....
23716	6592	" " " Bushing.....
23726	6592	" " " Hinge Pin.....

NO.	PLATE	NAME
231C	6592	Feed (back) Bar Set Screw
38426	6592	" " " Slide Block
38427	6490	" " Connecting Rod with 1057E, 23865 and two 896E
*23865	—	Feed (back) Connecting Rod Cap.
896E	6609	" " " " " Screw..
23866	6592	" " " " Hinge Pin (eccentric)
46439	6592	Feed (back) Connecting Rod Hinge Pin Bushing
178F	6609	Feed (back) Connecting Rod Hinge Pin Bushing Clamping Screw
1057E	6609	Feed (back) Connecting Rod Hinge Pin Clamping Screw
52960	6605	Feed (back) Dog
704C	6609	" " " Screw
38429	6592	" " Lifting Eccentric with two 465c
46336H	6500	Feed (back) Lifting Eccentric Cover
335D	6500	" " " " " Screw
465C	6592	" " " " " Set Screw..
52896	6594	" (front) Bar with 174D
50109F	6610	" " " Hinge Screw
52897	6594	" " Connecting Rod with two 174D
174D	6609	Feed (front) Connecting Rod Adjusting Screw
1131c	6610	Feed (front) Connecting Rod Hinge Screw
171D	6609	" " " " " " " Clamping Screw
52961	6605	Feed (front) Dog
52899	6592	" " " Holder
52900	6592	" " " " Crank with 211F
211F	6592	" " " " " Clamping Screw
52901	6592	Feed (front) Dog Holder Crank Connect- ing Link
999F	6592	Feed (front) Dog Holder Crank Connect- ing Link Hinge Screw (lower)
999F	6592	Feed (front) Dog Holder Crank Connect- ing Link Hinge Screw (upper)
211c	6592	Feed (front) Dog Screw
52902	6594	" " Lifting Eccentric with two 448c
448c	6610	Feed (front) Lifting Eccentric Set Screw..
52903	6587	" " " Rock Shaft
*46445	—	" " " " " Bracket

NO.	PLATE	NAME
129E	6609	Feed (front) Lifting Rock Shaft Bracket Screw (back)
965D	6609	Feed (front) Lifting Rock Shaft Bracket Screw (front)
52904	6594	Feed (front) Lifting Rock Shaft Crank (back) forked, with 647D
647D	6609	Feed (front) Lifting Rock Shaft Crank (back) Clamping Screw
46447	6594	Feed (front) Lifting Rock Shaft Crank (back) Slide Block
52905	6594	Feed (front) Lifting Rock Shaft Crank (front) with two each 178D and 197D...
197D	6609	Feed (front) Lifting Rock Shaft Crank (front) Adjusting Screw
178D	6609	Feed (front) Lifting Rock Shaft Crank (front) Clamping Screw
50110c	6595	Feed (front) Regulating Stud
1701c	6595	" " " " Nut
46449	6595	" " " " Sleeve
*38127	—	" Eccentric
*52906	—	" " Body
443c	6595	" " " Set Screw
21331	6595	" " Pressure Spring
21332	6595	" " " " Cap
934D	6595	" " " " " Screw
196F	6595	" " Set Screw
217D	6595	" " Stop Screw
52907	6595	Feed Eccentric (adjustable) complete, Nos. 196F, 217D, 934D, 1103c, 21331, 21332, 38127, 52906 and two 443c
1103c	6595	Feed Regulating Screw
52908	6594	" Rocking Frame with 178F
38432	6594	" " " Bracket with two 465c
123E	6597	Feed Rocking Frame Bracket Screw
38433	6594	" " " Hinge Pin
465c	6592	" " " " " Set Screw
46335	6607	Looper with 590D and 38393
46226	6490	" Bell Crank with 1037c
38436	6490	" " " Hinge Stud
443c	6610	" " " " " Set Screw.
46227	6587	Looper Bell Crank Pitman complete, Nos. 1706E, 1713E and 46233 to 46235
50070c	6610	Looper Bell Crank Pitman Ball Screw Stud (upper)
1636E	6610	Looper Bell Crank Pitman Ball Screw Stud (upper) Nut

NO.	PLATE	NAME
46228	6596	Looper Bell Crank Pitman Ball Stud (lower)
1037c	6610	Looper Bell Crank Pitman Ball Stud (lower) Set Screw
*46229	—	Looper Bell Crank Pitman Cap (lower)
171E	6609	" " " " " " Screw
*46230	—	Looper Bell Crank Pitman Cap (upper)
171E	6609	" " " " " " Screw
*46231	—	Looper Bell Crank Pitman End Bearing (lower)
*46232	—	Looper Bell Crank Pitman End Bearing (upper)
46233	6587	Looper Bell Crank Pitman Head (lower) Nos. 46228, 46229, 46231 and two 171E
46234	6587	Looper Bell Crank Pitman Head (upper) Nos. 46230, 46232, 50070c and two 171E
46235	6587	Looper Bell Crank Pitman Rod
1706E	6610	" " " " " " Nut (lower)
1713E	6610	Looper Bell Crank Pitman Rod Nut (upper)
38439	6596	Looper Carrier with 1143c and two 1147c
38440	6596	" " Hinge Pin
1147c	6596	" " " " Set Screw
46367	6587	Looper Carrier Pitman complete, Nos. 1708E, 1709E, 46176, 46241 and 46242
50070c	6610	Looper Carrier Pitman Ball Screw Stud (right)
1636E	6610	Looper Carrier Pitman Ball Screw Stud (right) Nut
46237	6596	Looper Carrier Pitman Ball Stud (left)
1147c	6596	" " " " " " Set Screw
*46238	—	Looper Carrier Pitman Cap (left)
171E	6609	" " " " " " Screw
*46238	—	" " " " (right)
171E	6609	" " " " " " Screw
*46239	—	" " " " End Bearing (left)
*46240	—	Looper Carrier Pitman End Bearing (right)
46241	6587	Looper Carrier Pitman Head (left) Nos. 46237 to 46239 and two 171E
46242	6587	Looper Carrier Pitman Head (right) Nos. 46238, 46240, 50070c and two 171E

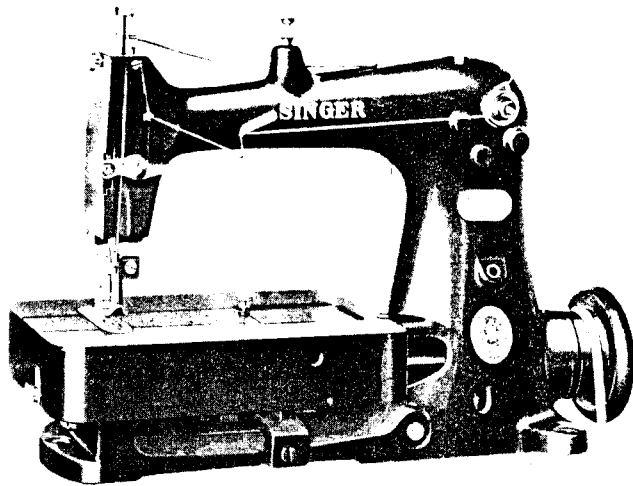
NO.	PLATE	NAME
46176	6587	Looper Carrier Pitman Rod
1708E	6610	" " " " Nut (left)
1709E	6610	" " " " " " (right)
46244	6601	" " " " Washer (fibre)
46042	6607	" " " " Rock Shaft with two 175D
175D	6596	" " " " Adjusting Screw
38450	6607	Looper Carrier Rock Shaft Crank (forked) with 159E
159E	6596	Looper Carrier Rock Shaft Crank Clamping Screw
38451	6596	Looper Carrier Rock Shaft Crank Slide Block
46043	6596	Looper Carrier Rock Shaft Hinge Pin
1508E	6596	" " " " " " Nut
129E	6609	" " " " " " Set Screw
38452	6596	Looper Eccentric with two 465c
465c	6596	" " Set Screw
52661	6500	" Needle Guard with 46105
46105	6596	" " " Pin
229D	6596	" " " Screw
1143c	6596	" Set Screw
38453	6597	" Shaft
52553	6597	" " Bracket
123E	6597	" " " Screw
391D	6597	" " " Screw
38393	6607	" " Thread Guard
590D	6607	" " " Screw
38008	6598	Needle Bar (hollow) with 857H
38456	6597	" " Bushing
1133E	6597	" " " Set Screw
38458	6607	" " Connecting Link
38459	6607	" " " " Hinge Stud
1520E	6597	" " " " " " Nut
38460	6607	Needle Bar Connecting Stud with two 391E
391E	6597	Needle Bar Connecting Stud Clamping Screw
53160	6601	Needle Guard
53161	6601	" " Holder
190D	6601	" " " Screw
53162	—	Needle Guard complete, Nos. 185H, 53160 and 53161
185H	6601	Needle Guard Screw
857H	6600	" Set Screw

NO.	PLATE	NAME
46092	6598	Presser Bar.....
46338	6597	" " Bushing (lower).....
1133E	6597	" " " " Set Screw.....
38456	6597	" " " (upper).....
1133E	6597	" " " " Set Screw.....
17541	6601	" " Lifter.....
17542	6595	" " " Hinge Pin.....
38466	6601	" " Lifting Bracket with 453c and 892c.....
892c	6595	Presser Bar Lifting Bracket Adjusting Screw.....
453c	6595	Presser Bar Lifting Bracket Set Screw.....
38467	6587	" " Spring (flat).....
38468	6608	" " " Stud.....
53042	6605	Presser Foot Extension.....
240D	6605	" " " " Screw.....
18055	6608	" " Hinge Pin.....
53043	—	" " Plate.....
23907	—	" " Shank.....
53044	6605	Presser Foot (hinged) complete, Nos. 240D, 18055, 23907, 53042 and 53043.....
190D	6500	Presser Foot Screw.....
574D	6536	Pressure Regulating Thumb Screw.....
1539D	6610	" " " " Lock Nut.....
52966	6607	Slack Thread Controller.....
193F	6500	" " " " Set Screw.....
52626	6599	" " Regulator.....
52569	6599	" " " Bracket with 704c and 1823.....
704c	6599	Slack Thread Regulator Bracket Clamping Screw.....
38474	6599	Slack Thread Regulator Bushing.....
1823	6599	" " " Roller and Stud.....
50062D	6599	" " " " Screw.....
1620E	6599	" " " " Nut.....
2102	6601	Tension (under thread) Disc.....
1560c	6601	" " " Regulating Thumb Nut.....
916F	6601	Tension (under thread) Screw Stud.....
10148	6601	" " " Spring.....
17547	6601	" " " Thread Guide.....
2102	6601	" (upper thread) Disc.....
1560c	6601	" " " Regulating Thumb Nut.....
916F	6601	Tension (upper thread) Screw Stud.....
2103	6601	" " " Spring.....

NO.	PLATE	NAME
17547	6601	Tension (upper thread) Thread Guide.....
38225	6497	Thread (under) Eyelet (back).....
190D	6497	" " " " Screw.....
38284	6497	" " " (front).....
46049	6497	" " Nipper Cam with 465c.....
465c	6497	" " " " Set Screw.....
38210	6497	" " " Spring (lower).....
38211	6497	" " " " (upper).....
46247	6497	" " " " " Stop 176D 6497 " " " " Screw.....
38475	6497	" " Take-up with 465c.....
465c	6497	" " " Set Screw.....
38478	6497	" " " Staple with two each 590D and 38481.....
46040	6594	Thread (under) Take-up Staple Bracket with 910c.....
690D	6609	Thread (under) Take-up Staple Bracket Screw.....
46041	6497	Thread (under) Take-up Staple Spring 190D 6497 " " " " " " Screw.....
910c	6497	Thread (under) Take-up Staple Stop Screw.....
38481	6497	Thread (under) Take-up Staple Thread Guard.....
590D	6497	Thread (under) Take-up Staple Thread Guard Screw.....
38482	6497	Thread (under) Take-up Stripper.....
207D	6599	" " " " " Screw..
38476	6497	" " " " Thread Guard (left).....
207D	6497	Thread (under) Take-up Thread Guard (left) Screw.....
38477	6497	Thread (under) Take-up Thread Guard (right).....
207D	6497	Thread (under) Take-up Thread Guard (right) Screw.....
38483	6608	Thread (upper) Controller.....
206F	6608	" " " " Screw.....
52627	6608	" " Eyelet.....
190D	6608	" " " " Screw.....
46312	6500	" " Take-up with 223D.....
223D	6500	" " " " Clamping Screw..
52967	6605	Throat Plate for 52960 and 52961.....
691F	6609	" " " " Screw.....

LIST OF PARTS COMPLETE

FOR



MACHINE No. 62-57

FOR TRIMMING AND STITCHING KNIT GOODS AND OTHER FABRICS.
ONE NEEDLE. ONE LOOPER. HAS AUXILIARY FEED MECHAN-
ISM AND VERTICAL SHEER TRIMMER ADJUSTABLE TO TRIM
FROM $\frac{1}{8}$ TO $\frac{3}{8}$ INCH FROM THE NEEDLE. BALANCE WHEEL
NO. 23873. DIAMETER OF BELT GROOVE $2\frac{1}{8}$ INCHES.

NO.	PLATE	NAME
*52968	—	Arm, upper and lower (solid) with 129E, 965D and 46445.
52630	6608	Arm Oil Tube with 49092, for oiling 46221
49092	6608	" " " Packing (felt)
46216	6490	" Rock Shaft
46217	6588	" " " Crank (back) with two 1497c.
1497c	6588	Arm Rock Shaft Crank (back) Set Screw.
38412	6588	" " " " (front) with 443c
23724	6588	" " " " " Pin
443c	6588	" " " " " Set Screw.

NO.	PLATE	NAME
46343	6589	Arm Rotary Shaft.
38329	6588	" " " Collar with two 457c.
457c	6588	" " " Set Screw
23872	6490	" " " Flanged Bushing
159F	6609	" " " " " Screw
4784	6608	" " " Oil Pad (felt)
144d	6609	" " " Screw
17509	6490	" Side Cover (lower)
286d	4875	" " " Thumb Screw
52554	6490	" " " (upper)
9533	6608	" " " Pin
176d	6497	" " " " Screw
23873	6589	Balance Wheel, $2\frac{1}{8}$ in. pulley, with two 430c.
430c	6610	Balance Wheel Set Screw
52946	6590	Cloth Plate
691F	6609	" " " Screw (left)
1094F	6609	" " " (right)
52947H	—	" " Slide (left)
52948	6591	Cloth Plate Slide (left) complete, Nos. 38419, 52947H and two 725H.
38419	6500	Cloth Plate Slide (left) Spring
725H	6500	" " " " " Screw
46463H	6591	" " " (right) with 1602H.
1602H	6610	" " " " Bushing
286d	4875	" " " " Thumb Screw
52969	—	Cloth Plate complete, Nos. 286d, 46463H, 52946 and 52948.
46221	6490	Crank Connecting Rod with 46222, 46223 and two each 896E and 1057E.
50069c	6610	Crank Connecting Rod Ball Screw Stud
1619E	6610	" " " " " " " Nut
*46222	—	Crank Connecting Rod Cap (lower)
896E	6609	" " " " " " Screw
*46223	—	" " " " " (upper)
1057E	6609	" " " " " " Screw
46225	6597	" " " " Washer (fibre)
46179	6490	Face Plate
46111	6608	" " Pin
286d	4875	" " Thumb Screw
46332	6595	Feed (back) Bar with 231c.
23716	6592	" " " Bushing
23726	6592	" " " Hinge Pin
231c	6592	" " " Set Screw
38426	6592	" " " Slide Block

NO.	PLATE	NAME
38427	6490	Feed (back) Connecting Rod with 1057E, 23865 and two 896E.....
*23865	—	Feed (back) Connecting Rod Cap.....
896E	6609	" " " " " Screw..
23866	6592	" " " " Hinge Pin (eccentric).....
46439	6592	Feed (back) Connecting Rod Hinge Pin Bushing.....
178F	6609	Feed (back) Connecting Rod Hinge Pin Bushing Clamping Screw.....
1057E	6609	Feed (back) Connecting Rod Hinge Pin Clamping Screw.....
52970	6606	Feed (back) Dog.....
704C	6609	" " " Screw.....
52896	6594	" (front) Bar with 171D.....
50109F	6610	" " " Hinge Screw.....
52897	6594	" " Connecting Rod with two 174D.....
174D	6609	Feed (front) Connecting Rod Adjusting Screw.....
1131c	6610	Feed (front) Connecting Rod Hinge Screw
171D	6609	" " " " " " " Clamping Screw.....
52971	6606	Feed (front) Dog.....
52899	6592	" " " Holder.....
52900	6592	" " " " Crank with 211F
211F	6592	" " " " Clamping Screw.....
52901	6592	Feed (front) Dog Holder Crank Connecting Link.....
999F	6592	Feed (front) Dog Holder Crank Connecting Link Hinge Screw (lower).....
999F	6592	Feed (front) Dog Holder Crank Connecting Link Hinge Screw (upper).....
211c	6592	Feed (front) Dog Screw.....
52902	6594	" " Lifting Eccentric with two 448c.....
448c	6610	Feed (front) Lifting Eccentric Set Screw.
52903	6587	" " " Rock Shaft.....
*46445	—	" " " " " Bracket.
129E	6609	" " " " " " Screw (back).....
965D	6609	Feed (front) Lifting Rock Shaft Bracket Screw (front).....
52904	6594	Feed (front) Lifting Rock Shaft Crank (back) forked, with 647D.....

NO.	PLATE	NAME
647D	6609	Feed (front) Lifting Rock Shaft Crank (back) Clamping Screw.....
46447	6594	Feed (front) Lifting Rock Shaft Crank (back) Slide Block.....
52905	6594	Feed (front) Lifting Rock Shaft Crank (front) with two each 178D and 197D..
197D	6609	Feed (front) Lifting Rock Shaft Crank (front) Adjusting Screw.....
178D	6609	Feed (front) Lifting Rock Shaft Crank (front) Clamping Screw.....
50110c	6595	Feed (front) Regulating Stud.....
1701c	6595	" " " " Nut.....
46449	6595	" " " " Sleeve.....
*38127	—	" Eccentric.....
*52906	—	" " Body.....
443c	6595	" " " Set Screw.....
21331	6595	" " Pressure Spring.....
21332	6595	" " " " Cap.....
934D	6595	" " " " " Screw
196F	6595	" " Set Screw.....
217D	6595	" " Stop Screw.....
52907	6595	Feed Eccentric (adjustable) complete, Nos. 196F, 217D, 934D, 1103c, 21331, 21332, 38127, 52906 and two 443c.....
1103c	6595	Feed Regulating Screw.....
52908	6594	" Rocking Frame with 178F.....
38432	6594	" " " Bracket with two 465c.....
123E	6597	Feed Rocking Frame Bracket Screw.....
38433	6594	" " " Hinge Pin.....
465c	6592	" " " " " Set Screw
52744	6504	Knife (movable) with 52745 and two 1053D
52745	6504	" " Chip Ejector.....
1053D	6504	" " " " Screw..
52741	6504	" " Connection with 904c..
46347	6504	" " " Crank.....
46348	6504	" " " " Bracket with 453c.....
134D	6604	Knife (movable) Connection Crank Bracket Screw.....
11204	6504	Knife (movable) Connection Crank Hinge Stud.....
453c	6504	Knife (movable) Connection Crank Hinge Stud Set Screw.....
46349	6504	Knife (movable) Connection Extension
203D	6504	" " " " Screw.....

NO.	PLATE	NAME
40247	6504	Knife (movable) Connection Hinge Pin...
904c	6504	" " " " " " Set Screw.....
52742	6504	Knife (movable) Eccentric with two 457c
457c	6504	" " " " Set Screw.....
1042c	6504	" " " " Hinge Screw.....
1554E	6504	" " " " Nut.....
46351	6504	" (stationary).....
46352	6504	" " Adjusting Lever.....
191c	6504	" " " " Screw
1250F	6504	" " " " " "
		Stud.....
52659	6504	Knife (stationary) Stop.....
203D	6504	" " " Adjusting Screw (lower).....
203D	6504	Knife (stationary) Stop Adjusting Screw (upper).....
52660	6504	Knife Bracket.....
46355	6504	" " Holder with two 178F.....
178F	6504	" " " Clamping Screw...
898D	6609	" " Screw.....
46356	—	Knife Bracket complete, Nos. 191c, 1042c, 1250F, 1554E, 46351, 46352, 52659, 52660, 52744 and two 203D.....
46335	6607	Looper with 590b and 38393.....
46226	6490	" Bell Crank with 1037c.....
38436	6490	" " " Hinge Stud.....
443c	6610	" " " " " " Set Screw.
46227	6587	Looper Bell Crank Pitman complete, Nos. 1706E, 1713E and 46233 to 46235.....
50070c	6610	Looper Bell Crank Pitman Ball Screw Stud (upper).....
1636E	6610	Looper Bell Crank Pitman Ball Screw Stud (upper) Nut.....
46228	6596	Looper Bell Crank Pitman Ball Stud (lower).....
1037c	6610	Looper Bell Crank Pitman Ball Stud (lower) Set Screw.....
*46229	—	Looper Bell Crank Pitman Cap (lower)
171E	6609	" " " " " " "
		Screw.....
*46230	—	Looper Bell Crank Pitman Cap (upper)
171E	6609	" " " " " " "
		Screw.....
*46231	—	Looper Bell Crank Pitman End Bearing (lower).....

NO.	PLATE	NAME
*46232	—	Looper Bell Crank Pitman End Bearing (upper).....
46233	6587	Looper Bell Crank Pitman Head (lower) Nos. 46228, 46229, 46231 and two 171E
46234	6587	Looper Bell Crank Pitman Head (upper) Nos. 46230, 46232, 50070c and two 171E
46235	6587	Looper Bell Crank Pitman Rod.....
1706E	6610	" " " " " " N u t (lower).....
1713E	6610	Looper Bell Crank Pitman Rod Nut (upper).....
52784	6607	Looper Carrier with 1143c and two 1147c
38440	6596	" " Hinge Pin.....
1147c	6596	" " " " Set Screw.....
46367	6587	Looper Carrier Pitman complete, Nos. 1708E, 1709E, 46176, 46241 and 46242
50070c	6610	Looper Carrier Pitman Ball Screw Stud (right).....
1636E	6610	Looper Carrier Pitman Ball Screw Stud (right) Nut.....
46237	6596	Looper Carrier Pitman Ball Stud (left)
1147c	6596	" " " " " " "
		Set Screw.....
*46238	—	Looper Carrier Pitman Cap (left).....
171E	6609	" " " " " " Screw..
*46238	—	" " " " " (right).....
171E	6609	" " " " " " Screw
*46239	—	" " " " End Bearing (left)
*46240	—	" " " " " (right)
46241	6587	" " " " Head (left) Nos. 46237 to 46239 and two 171E.....
46242	6587	Looper Carrier Pitman Head (right) Nos. 46238, 46240, 50070c and two 171E....
46176	6587	Looper Carrier Pitman Rod.....
1708E	6610	" " " " Nut (left)...
1709E	6610	" " " " " (right)...
46244	6601	" " " Washer (fibre)....
46042	6607	" " Rock Shaft with two 175D
175D	6596	" " " " Adjusting Screw.....
38450	6607	Looper Carrier Rock Shaft Crank (forked) with 159E.....
159E	6596	Looper Carrier Rock Shaft Crank Clamping Screw.....
38451	6596	Looper Carrier Rock Shaft Crank Slide Block.....

NO.	PLATE	NAME
46043	6596	Looper Carrier Rock Shaft Hinge Pin...
1508E	6596	" " " " " " " Nut
129E	6609	" " " " " " " Set Screw.....
38452	6596	Looper Eccentric with two 465c.....
46336H	6500	" " " Cover.....
335D	6500	" " " Screw.....
465c	6596	" " " Set Screw.....
52661	6500	" Needle Guard with 46105.....
46105	6596	" " " Pin.....
229D	6596	" " " Screw.....
1143c	6596	" Set Screw.....
52743	6607	" Shaft and Feed (back) Lifting Eccentric.....
52553	6597	Looper Shaft and Feed (back) Lifting Eccentric Bracket.....
123E	6597	Looper Shaft and Feed (back) Lifting Eccentric Bracket Screw.....
391D	6597	Looper Shaft and Feed (back) Lifting Eccentric Screw.....
38393	6607	Looper Thread Guard.....
590D	6607	" " " Screw.....
38455	6598	Needle Bar (hollow) with 857H.....
38456	6597	" " " Bushing.....
1133E	6597	" " " Set Screw.....
38458	6607	" " " Connecting Link.....
38459	6607	" " " " Hinge Stud.....
1520E	6597	" " " " " " " Nut.....
38460	6607	Needle Bar Connecting Stud with two 391E.....
391E	6597	Needle Bar Connecting Stud Clamping Screw.....
53160	6601	Needle Guard.....
53161	6601	" " " Holder.....
190D	6601	" " " " Screw.....
53162	—	Needle Guard complete, Nos. 185H, 53160 and 53161.....
185H	6601	Needle Guard Screw.....
857H	6600	" Set Screw.....
17540	6598	Presser Bar.....
46359	6601	" " " Bushing (lower).....
1133E	6597	" " " " Set Screw...
38456	6597	" " " " (upper).....
1133E	6597	" " " " Set Screw...
17541	6601	" " " Lifter.....
17542	6595	" " " " Hinge Pin.....

NO.	PLATE	NAME
38456	6601	Presser Bar Lifting Bracket with 453c and 592c.....
592c	6596	Presser Bar Lifting Bracket Adjusting Screw.....
453c	6596	Presser Bar Lifting Bracket Set Screw.....
38457	6597	" " " Spring Bar.....
38458	6608	" " " " Stop.....
18255	6608	" Foot Hinge Pin.....
46360	—	" " " Plate.....
46361	—	" " " Shank.....
46262	6606	Presser Foot, forged complete, Nos. 18055, 46360 and 46361.....
18055	6500	Presser Foot Screw.....
574D	6536	Pressure Regulating Thumb Screw.....
1539D	6610	" " " " " " Lock Nut.....
46169	6500	Slack Thread Controller.....
211F	6592	" " " " Set Screw.....
52626	6599	" " " Regulator.....
52569	6599	" " " " Bracket with 704c and 1823.....
704c	6599	Slack Thread Regulator Bracket Clamping Screw.....
38474	6599	Slack Thread Regulator Bushing.....
1823	6599	" " " " Roller and Stud.....
50062D	6599	" " " " Screw.....
1620E	6599	" " " " " Nut.....
2102	6601	Tension (under thread) Disc.....
1560c	6601	" " " " Regulating Thumb Nut.....
916F	6601	Tension (under thread) Screw Stud.....
10148	6601	" " " " Spring.....
17547	6601	" " " " Thread Guide.....
2102	6601	" (upper thread) Disc.....
1560c	6601	" " " " Regulating Thumb Nut.....
916F	6601	Tension (upper thread) Screw Stud.....
2103	6601	" " " " Spring.....
17547	6601	" " " " Thread Guide.....
38225	6497	Thread (under) Eyelet (back).....
190D	6497	" " " " " Screw.....
38284	6497	" " " " (front).....
46049	6497	" " " " Nipper Cam with 465c.....
465c	6497	" " " " Set Screw...
38210	6497	" " " " Spring (lower)...
38211	6497	" " " " " (upper)...
46247	6497	" " " " " " Stop.....

NO.	PLATE	NAME
176D	6497	Thread (under) Nipper Spring Screw....
38475	6497	" " Take-up with 465c.....
465c	6497	" " Set Screw.....
38478	6497	" " " Staple with two each 590D and 38481.....
46040	6594	Thread (under) Take-up Staple Bracket with 910c.....
690D	6609	Thread (under) Take-up Staple Bracket Screw.....
46041	6497	Thread (under) Take-up Staple Spring
190D	6497	" " " " " " Screw.....
910c	6497	Thread (under) Take-up Staple Stop Screw.....
38481	6497	Thread (under) Take-up Staple Thread Guard.....
590D	6497	Thread (under) Take-up Staple Thread Guard Screw.....
38482	6497	Thread (under) Take-up Stripper.....
207D	6599	" " " " Screw..
38476	6497	" " " Thread Guard (left).....
207D	6497	Thread (under) Take-up Thread Guard (left) Screw.....
38477	6497	Thread (under) Take-up Thread Guard (right).....
207D	6497	Thread (under) Take-up Thread Guard (right) Screw.....
38483	6608	Thread (upper) Controller.....
206F	6608	" " " Screw.....
52627	6608	" " Eyelet.....
190D	6608	" " " Screw.....
46312	6500	" " Take-up with 223D.....
223D	6500	" " " Clamping Screw.
52972	6606	Throat Plate for 52970 and 52971.....
691F	6609	" " Screw.....

MACHINE BASE

FOR MACHINE NO. 62-55

NO.	PLATE	NAME
53119	6589	Belt Cover.....
181D	6609	" " Screw.....
52999	6589	Machine Base with 53119, two each 181D, wood screws 1¼ in. No. 12 and four each 131D, 42088 and 53000.....

NO.	PLATE	NAME
41721	—	Knife Grinder complete for 46351 and 52744, Nos. 261D, 1508c, 27323, 27564, 27565, 27567, 27569, 27572, 27573, 27659, 27662, 27822, 41719, 41720, two 27568, three wood screws 1 in. No. 10 and four each 310F and 1516F.....
27662	1104	Wrench for 1508 and 1516.....

THREAD UNWINDERS

THREAD UNWINDER

FOR TWO LARGE SPOOLS OR TWO LARGE CONES OF THREAD

NO.	PLATE	NAME
27623	2837	Spool Pin.....
155c	6609	" " Set Screw.....
41530	2837	" Rest.....
41531	—	" " 41530 with 1149c and two each 155c and 27623.....
1149c	6609	Spool Rest Set Screw.....
27940	2837	" Stand with 453c.....
41514	2837	" Weight, 4 in. diam., with 41515....
41515	6588	" " Centre Pin.....
27739	2837	Thread Cone (wood).....
41631	2837	" Guard with 208E and two 41569..
41569	6601	" " Eyelet.....
41637	2837	" " Rod (lower).....
41638	2837	" " " (upper).....
41639	2837	" " " Coupling with two 456c.....
456c	6610	Thread Guard Rod Coupling Set Screw.
41640	—	Thread Guard Rod complete, 30 in. long, Nos. 41637 to 41639.....
453c	6504	Thread Guard Rod Set Screw.....
208E	6600	" " Screw.....
41533	2837	Thread Unwinder complete, Nos. 27940, 41531, 41631, 41640, two each 27739, 41514 and three wood screws 1 in. No. 12.....

THREAD UNWINDER

FOR THREE LARGE SPOOLS OR THREE LARGE CONES OF THREAD

NO.	PLATE	NAME
27623	5571	Spool Pin.....
155c	6609	" " Set Screw.....

NO.	PLATE	NAME
41434	5571	Spool Rest.....
*60697	—	“ “ 41434 with 1149c and three 155c.....
41435	—	Spool Rest 60697 with three 27623.....
1149c	6609	“ “ Set Screw.....
27940	5571	“ Stand with 453c.....
41514	5571	“ Weight, 4 in. diam., with 41515.....
41515	6588	“ “ Centre Pin.....
27739	5571	Thread Cone (wood).....
41632	5571	“ Guard with 208E and three 41569.....
41569	6601	“ “ Eyelet.....
41637	5571	“ “ Rod (lower).....
41638	5571	“ “ “ (upper).....
41639	5571	“ “ “ Coupling with two 456c.....
456c	6610	Thread Guard Rod Coupling Set Screw.....
41640	—	Thread Guard Rod complete, 30 in. long, Nos. 41637 to 41639.....
453c	6504	Thread Guard Rod Set Screw.....
208E	6600	“ “ Screw.....
41438	5571	Thread Unwinder complete, Nos. 27940, 41435, 41632, 41640 and three each 27739, 41514 and wood screws 1 in. No. 12.....

OBSOLETE PARTS

NO.	PLATE	NAME
*46222	—	Crank Connecting Rod Cap (lower) for 46221.....
52781	6617	Cutting Plate for 52958, use 53122.....
52888	6614	Lifting Lever for 52889 and 52890.....
23759	6614	“ “ “ 23768 and 38385.....
23760	6614	“ “ Connecting Rod for 52890.....
23761	6614	“ “ Spring.....
46236	6615	Looper Carrier Pitman complete, Nos. 1708E, 1709E and 46241 to 46243, use 46367.....
46243	6615	Looper Carrier Pitman Rod for 46236, use 46176.....
52673	6616	Needle Guard for 62-57 Machine, use 53162.....
52962	6617	Needle Guard for 62-56 Machine, use 53162.....
52963	6616	Presser Foot Extension for 52965.....
52964	—	“ “ Plate for 52965.....

NO.	PLATE	NAME
52965	6616	Presser Foot (hinged) complete for 62-56 Machine, Nos. 240b, 18055, 23907, 52963 and 52964, use 53044.....
52924	6616	Throat Plate for 52895 and 52898.....
FOR MACHINE No. 62-55		
*52891	—	Arm, upper and lower (solid) with 129E 965D and 46445.....
52828	6617	Arm Rock Shaft Crank (front) with 443c and 448c.....
46221	6490	Crank Connecting Rod with 46222, 46223 and two each 896E and 1057E.....
52836	6615	Face Plate.....
52895	6616	Feed (Back) Dog.....
704c	6609	“ “ “ Screw.....
52909	6617	Looper with 590D and 52846.....
46042	6607	“ Carrier Rock Shaft with two 175D.....
38450	6607	“ “ “ “ Crank (forked) with 159E.....
52910	6617	Looper Needle Guard with 46105.....
38459	6607	Needle Bar Connecting Link Hinge Stud.....
52913	—	Presser Foot Plate for 52915.....
52915	6616	Presser Foot (hinged) complete, Nos. 26276, 46087 and 52913.....
52916	6615	Slack Thread Regulator, use 52994.....
52860	6617	Spreader Holder with 857H and 1253c.....
52917	6615	Tension (upper thread) Bracket.....
1698E	6610	“ “ “ Screw Stud Nut.....
52872	6617	Thread Carrier Bell Crank with three 462c.....
52873	6617	Thread Carrier Bell Crank Bracket.....
52878	6617	“ “ Holder with 857H and 1253c.....
52918	6616	Thread (under) Take-up with 465c.....
52883	6616	“ “ “ Staple.....
52919	6617	“ “ “ Stripper.....
52922	6615	“ (upper) Retainer Bracket.....
1094F	6609	“ “ “ “ Screw.....
2455	6617	“ “ “ Disc.....
1562D	6610	“ “ “ Regulating Thumb Nut.....
418D	6610	Thread (upper) Retainer Screw Stud.....
1529E	6610	“ “ “ “ Nut.....
10141	6617	“ “ “ Spring.....

NO.	PLATE	NAME
42088	6608	Machine Cushion (felt).....
53000	6608	" " (leather).....
131D	6609	" " Screw.....
1408J	6611	" Thumb Screw (for power table).
53009	6588	" " " Spring.....
9842	6588	" " " Washer.....

ATTACHMENTS AND ACCESSORIES

NO.	PLATE	NAME
2015	6597	Machine Cushion (rubber).....
4718	6608	" Rest (felt).....
—	—	1¾ in. Wood Screws No. 16, to secure machine to table.....
36563	6612	Oiler (copper plated) with 36564.....
36564	6612	" Spout, 5 in. long, with 120117.....
120117	6612	" " Washer (leather).....
26026	6612	Screw Driver (large).....
26485	6612	" " (small).....
38487	6612	Threading Wire.....
35095	6612	Tweezers, 6 in.....
4822	6612	Wrench for 1547 and 1698.....
10875	6612	" " 1518, 1520, 1620, 1701, 1706, 1708 and 1709.....
19221	6612	Wrench for 1619.....
22003	6612	" " 1550 and 1682.....
23766	6612	" " 1508 and 1636.....

EDGE GUIDE

FOR MACHINE NO. 62-55

NO.	PLATE	NAME
36649	6613	Edge Guide, for cuffs and anklets.....
36650	6613	" " " collarettes.....
36719	6613	" " " collarette work.....
1443F	6613	" " Screw.....

CUTTER GRINDER PARTS

FOR MACHINE NO. 62-56

NO.	PLATE	NAME
27565	1104	Emery Wheel, 2 in. diam.....
1508c	1105	" " Clamping Nut.....

SINGER Needles should be used
in SINGER Machines.
These Needles and their Containers
are marked with the
Company's Trade Mark "SIMANCO." 1

Needles in Containers marked
"FOR SINGER MACHINES"
are NOT SINGER made needles. 2

NO.	PLATE	NAME
27822	1105	Emery Wheel Clamping Nut Washer....
27567	1105	“ “ Shaft.....
27568	1105	“ “ “ Oil Hole Cover (rubber).....
27569	1105	Emery Wheel Shaft Pulley.....
310F	1105	“ “ “ Screw Centre.....
1516F	1105	“ “ “ “ “ Nut ..
27925	4874	Frame with 27574.....
27926	4875	Cutter Holder.....
27927	4874	“ “ Bracket with 27574.....
310F	1105	“ “ “ Screw Centre....
1516F	1105	“ “ “ “ “ Nut
27573	1105	“ “ “ Spring.....
27574	1105	“ “ “ “ Hook.....
27928	4875	“ “ Clamp with 27930.....
27929	4875	“ “ “ Spring.....
27930	4875	“ “ “ Steady Pin.....
939D	4875	“ “ “ Thumb Screw.....
27931	4875	“ “ Collar with two 460c....
460C	4875	“ “ “ Set Screw.....
27932	4875	“ “ Handle.....
27933	4875	“ “ Stop.....
286D	4875	“ “ “ Thumb Screw.....
261D	1105	“ Regulating Thumb Screw.....
27934	—	Cutter Grinder complete, Nos. 261D, 286D, 939D, 1508C, 27565, 27567, 27569, 27573, 27662, 27822, 27925 to 27929, 27931 to 27933, two 27568, three wood screws 1 in. No. 10 and four each 310F and 1516F.....
27662	1104	Wrench for 1508 and 1516.....

FOOT LIFTER PARTS

NO.	PLATE	NAME
6439	—	Chain, 36 in. to 45 in.....
NOTE: When ordering No. 6439 give length required.		
4879	6598	Chain Connecting Link.....
53010	6614	Lifting Lever for 52889.....
53011	6614	“ “ “ 23769.....
802D	6610	“ “ Hinge Screw.....
52521	6614	“ “ Spring.....
1002D	6610	“ “ Stop Screw.....
4881	6614	Treadle.....
4882	6598	“ Shaft.....
4883	6598	“ Spring.....

NO.	PLATE	NAME
4884	6614	Treadle Stand.....
4885	6614	Treadle complete, Nos. 4879, 4881 to 4884 and two wood screws 1 in. No. 16.....
52889	—	Foot Lifter complete for 62-55 Machine, Nos. 802D, 1002D, 4885, 6439, 52521 and 53010.....
23769	—	Foot Lifter complete for 62-56 and 62-57 Machines, Nos. 802D, 1002D, 4885, 6439, 52521 and 53011.....

KNEE LIFTER PARTS

NO.	PLATE	NAME
53010	6614	Lifting Lever for 52890.....
53011	6614	“ “ “ 23768 and 38385.....
38384	6614	“ “ Connecting Rod for 38385 and 52890.....
23760	6614	Lifting Lever Connecting Rod for 23768.
802D	6610	“ “ Hinge Screw.....
52521	6614	“ “ Spring.....
1002D	6610	“ “ Stop Screw.....
2763	6614	Rock Shaft.....
12242	6614	“ “ Hanger with two wood screws 1 in. No. 10.....
6335	6614	Rock Shaft Knee Arm.....
6336	—	Rock Shaft Knee Arm complete, Nos. 2766, 2767 and 6335.....
2766	6614	Rock Shaft Knee Arm Hub with 356c...
356C	6610	“ “ “ “ “ Set Screw....
2767	6614	“ “ “ Plate with 356c.....
356C	6610	“ “ “ “ Set Screw.....
6337	6614	“ “ Lifting Bracket with two 356c
7125	6614	“ “ “ “ Hook.....
356C	6610	“ “ “ “ “ S e t Screw.....
356C	6610	Rock Shaft Lifting Bracket Set Screw...
2770	6614	“ “ Stop Dog with 356c.....
356C	6610	“ “ “ “ Set Screw.....
23767	6614	Rock Shaft complete, Nos. 2763, 2770, 6336, 6337, 7125 and two 12242.....
52890	—	Knee Lifter complete for 62-55 Machine, Nos. 802D, 1002D, 23767, 38384, 52521 and 53010.....
23768	—	Knee Lifter complete (power table) for 62-56 and 62-57 Machines, Nos. 802D, 1002D, 23760, 23767, 52521 and 53011.

NO.	PLATE	NAME
38385	—	Knee Lifter complete (bench stand) for 62-56 and 62-57 Machines, Nos. 802b, 1002b, 23767, 38384, 52521 and 53011.

KNIFE GRINDER PARTS

FOR MACHINE NO. 62-57

NO.	PLATE	NAME
27565	1104	Emery Wheel, 2 in. diam.....
1508c	1105	" " Clamping Nut.....
27822	1105	" " " " Washer....
27567	1105	" " Shaft.....
27568	1105	" " " Oil Hole Cover (rubber).....
27569	1105	Emery Wheel Shaft Pulley.....
310F	1105	" " " Screw Centre.....
1516F	1105	" " " " " Nut....
27564	1104	Frame with 27574.....
1656b	6536	Knife Clamping Thumb Nut.....
41717	—	" Holder Body for 41719.....
41718	—	" " " " 41720.....
41719	6536	Knife Holder complete for 52744, Nos. 38b, 574b, 1528H, 1656b, 11833 and 41717.....
41720	6536	Knife Holder complete for 46351, Nos. 38b, 574b, 1528H, 1656b, 11833 and 41718.....
574b	6536	Knife Holder Adjusting Thumb Screw
1528H	6536	" " " " "
		Lock Nut.....
27323	1105	Knife Holder Guide Bar.....
27572	1104	" " " " Bracket with 27574.....
310F	1105	Knife Holder Guide Bar Bracket Screw Centre.....
1516F	1105	Knife Holder Guide Bar Bracket Screw Centre Nut.....
27573	1105	Knife Holder Guide Bar Bracket Spring
27574	1105	" " " " " " "
		Hook.....
27659	1105	Knife Holder Stop Collar with 237F....
237F	1105	" " " " Set Screw....
11833	6536	" Position Pin.....
261b	1105	" Regulating Thumb Screw.....
38b	6536	" Screw.....

NUMERICAL LIST OF PARTS

NO.	PLATE	NAME
456c	6610	Thread Unwinder Thread Guard Rod Coupling Set Screw for 41639.....
457c	6588	Arm Rotary Shaft Collar Set Screw for 38329.....
457c	6604	Cutting Lever Eccentric Set Screw for 52952.....
457c	6504	Knife (movable) Eccentric Set Screw for 52742.....
460c	4875	Feed (back) Dog Stop Screw for 38425....
460c	4875	Cutter Grinder Cutter Holder Collar Set Screw for 27931.....
462c	6602	Thread Carrier Bell Crank Connection Hinge Stud (lower) Set Screw for 52872 and 52996.....
462c	6602	Thread Carrier Bell Crank Hinge Stud Set Screw for 52872 and 52996.....
462c	6610	Thread Carrier Pitman Ball Stud (back) Set Screw for 52872 and 52996.....
465c	6592	Feed (back) Lifting Eccentric Set Screw for 38429.....
465c	6592	Feed Rocking Frame Hinge Pin Set Screw for 38432.....
465c	6596	Looper Eccentric Set Screw for 38452....
465c	6497	Thread (under) Nipper Cam Set Screw for 46049.....
465c	6497	Thread (under) Take-up Set Screw for 38475, 52918 and 53171.....
574b	6536	Pressure Regulating Thumb Screw.....
574b	6536	Knife Grinder Knife Holder Adjusting Thumb Screw for 41719 and 41720....
590b	6596	Looper Thread Guard Screw for 46335, 52844 and 52909.....
590b	6497	Thread (under) Take-up Staple Thread Guard Screw for 38478.....
647b	6609	Feed (front) Lifting Rock Shaft Crank (back) Clamping Screw for 52904.....
690b	6604	Cutting Plate Bracket Holder Adjusting Screw for 62-56 Machine.....
690b	6609	Thread (under) Take-up Staple Bracket Screw.....
691f	6609	Cloth Plate Screw (left).....
691f	6609	Throat Plate Screw.....
704c	6609	Feed (back) Dog Screw for 62-56 and 62-57 Machines and obsolete for 62-55 Machine.....
704c	6599	Slack Thread Regulator Bracket Clamping Screw for 52569.....

NUMERICAL

FOR PARTS

NUMERICAL

LIST

OF PARTS

NUMERICAL LIST OF PARTS

NO.	PLATE	NAME
725H	6500	Cloth Plate Slide (large) Spring Screw for 52893.....
725H	6500	Cloth Plate Slide (left) Spring Screw for 52948.....
725H	6500	Cloth Plate Slide (small) Spring Screw for 52834.....
788D	6604	Cutting Lever Eccentric Connection Lever Hinge Screw for 62-56 Machine.....
802D	6610	Lifting Lever Hinge Screw for 23768, 23769, 38385, 52889 and 52890.....
857H	6600	Needle Set Screw for 38008 and 38455.....
857H	6600	Spreader Set Screw for 52860 and 52995.....
857H	6600	Thread Carrier Set Screw for 52878 and 52998.....
892c	6595	Presser Bar Lifting Bracket Adjusting Screw for 38466 and 52852.....
896E	6609	Crank Connecting Rod Cap (lower) Screw for 46221 and 52990.....
896E	6609	Feed (back) Connecting Rod Cap Screw for 38427.....
898D	6609	Knife Bracket Screw for 62-57 Machine.....
904c	6504	" (movable) Connection Hinge Pin Set Screw for 52741.....
904F	6597	Needle Set Screw for 52911.....
910c	6497	Thread (under) Take-up Staple Stop Screw for 46010.....
916F	6601	Tension (thread carrier) Screw Stud for 62-55 Machine.....
916F	6601	Tension (under thread) Screw Stud.....
916F	6601	" (upper thread) Screw Stud for 62-56 and 62-57 Machines.....
934D	6595	Feed Eccentric Pressure Spring Cap Screw for 52907.....
939D	4875	Cutter Grinder Cutter Holder Clamp Thumb Screw for 27934.....
965D	6609	Feed (front) Lifting Rock Shaft Bracket Screw (front) for 52891, 52944, 52968 and 52988.....
999F	6592	Feed (front) Dog Holder Crank Connecting Link Hinge Screw (lower).....
999F	6592	Feed (front) Dog Holder Crank Connecting Link Hinge Screw (upper).....
1002D	6610	Lifting Lever Stop Screw for 23768, 23769, 38385, 52889 and 52890.....
1037c	6610	Looper Bell Crank Pitman Ball Stud (lower) Set Screw for 46226.....

NUMERICAL LIST OF PARTS

NO.	PLATE	NAME
1042c	6604	Cutting Lever Eccentric Connection Hinge Screw for 62-56 Machine.....
1042c	6504	Knife (movable) Hinge Screw for 46356.....
1053D	6504	" " Chip Ejector Screw for 52744.....
1057E	6609	Crank Connecting Rod Cap (upper) Screw for 46221 and 52990.....
1057E	6609	Feed (back) Connecting Rod Hinge Pin Clamping Screw for 38427.....
1094F	6609	Cloth Plate Screw (right).....
1094F	6609	Thread (upper) Retainer Bracket Screw for 62-55 Machine, obsolete.....
1103c	6595	Feed Regulating Screw for 52907.....
1131c	6610	" (front) Connecting Rod Hinge Screw.....
1133E	6597	Needle Bar Bushing Set Screw.....
1133E	6597	Presser Bar Bushing (lower) Set Screw.....
1133E	6597	" " " (upper) Set Screw.....
1143c	6596	Looper Set Screw for 38439 and 52784.....
1147c	6596	" Carrier Hinge Pin Set Screw for 38439 and 52784.....
1147c	6596	Looper Carrier Pitman Ball Stud (left) Set Screw for 38439 and 52784.....
1149c	6609	Thread Unwinder Spool Rest Set Screw for 41531 and 60697.....
1246c	6603	Cutting Plate Adjusting Screw for 52958.....
1247D	6603	" Lever Connecting Link Hinge Screw (upper) for 62-56 Machine.....
1247c	6603	Cutting Lever Hinge Screw for 52958.....
1247c	6603	" Plate Friction Plate Screw for 52958.....
1250F	6504	Knife (stationary) Adjusting Lever Screw Stud for 46356.....
1253c	6600	Spreader Holder Hinge Stud Set Screw for 52860 and 52995.....
1253c	6600	Spreader Pitman Ball Stud (front) Set Screw for 52879.....
1253c	6600	Thread Carrier Holder Bracket Set Screw for 52879.....
1253c	6600	Thread Carrier Holder Hinge Stud Set Screw for 52879.....
1253c	6600	Thread Carrier Pitman Ball Stud (front) Set Screw for 52878 and 52998.....
1259c	6610	Looper Bell Crank Pitman Ball Stud (lower) Set Screw for 46145.....
1389F	6603	Cutting Lever Adjusting Screw for 52958.....
1408J	6611	Machine Thumb Screw (for power table) for 62-55 Machine.....

NO.	PLATE	NAME
1443F	6613	Edge Guide Screw for 62-55 Machine....
1449H	6597	Needle Clamp Thread Retainer Screw for 62-55 Machine.....
1497c	6588	Arm Rock Shaft Crank (back) Set Screw for 46217 and 46364.....
1508c	1105	Cutter Grinder Emery Wheel Clamping Nut for 27934.....
1508c	1105	Knife Grinder Emery Wheel Clamping Nut for 41721.....
1508E	6596	Looper Carrier Rock Shaft Hinge Pin Nut
1516F	1105	Cutter Grinder Cutter Holder Bracket Screw Centre Nut for 27934.....
1516F	1105	Cutter Grinder Emery Wheel Shaft Screw Centre Nut for 27934.....
1516F	1105	Knife Grinder Emery Wheel Shaft Screw Centre Nut for 41721.....
1516F	1105	Knife Grinder Knife Holder Guide Bar Bracket Screw Centre Nut for 41721...
1518E	6610	Looper Bell Crank Pitman Ball Screw Stud (upper) Nut for 62-55 Machine...
1520E	6597	Needle Bar Connecting Link Hinge Stud Nut.....
1528H	6536	Knife Grinder Knife Holder Adjusting Thumb Screw Lock Nut for 41719 and 41720.....
1529E	6610	Thread (upper) Retainer Screw Stud Nut for 62-55 Machine, obsolete.....
1539D	6610	Pressure Regulating Thumb Screw Lock Nut.....
1547D	6604	Cutting Lever Eccentric Connection Hinge Screw Nut for 62-56 Machine.....
1550H	6600	Spreader Pitman Rod Nut (front) for 52862.....
1550H	6600	Thread Carrier Pitman Rod Nut (front) for 52862.....
1554E	6504	Knife (movable) Hinge Screw Nut for 46356.....
1560c	6601	Tension (thread carrier) R e g u l a t i n g Thumb Nut for 62-55 Machine.....
1560c	6601	Tension (under thread) R e g u l a t i n g Thumb Nut.....
1560c	6601	Tension (upper thread) R e g u l a t i n g Thumb Nut.....
1562D	6610	Thread (upper) Retainer Regulating Thumb Nut for 62-55 Machine, obsolete
1602H	6610	Cloth Plate Slide (right) Bushing for 46463H and 52631H.....

NUMERICAL LIST OF PARTS

NO.	PLATE	NAME
38D	6536	Knife Grinder Knife Screw for 41719 and 41720.....
87F	6603	Cutting Plate Hinge Screw for 52958....
123E	6597	Feed Rocking Frame Bracket Screw.....
123E	6597	Looper Shaft Bracket Screw for 62-55 and 62-56 Machines.....
123E	6597	Looper Shaft and Feed (back) Lifting Eccentric Bracket Screw for 62-57 Machine.....
129E	6609	Feed (front) Lifting Rock Shaft Bracket Screw (back) for 52891, 52944, 52968 and 52988.....
129E	6609	Looper Carrier Rock Shaft Hinge Pin Set Screw.....
131D	6609	Machine Cushion Screw for 52999.....
134D	6604	Cutting Lever Eccentric Connection Lever Bracket Screw for 62-56 Machine.....
134D	6604	Knife (movable) Connection Crank Bracket Screw for 62-57 Machine.....
139E	6608	Thread (upper) Separating Screw for 62-55 Machine.....
144D	6609	Arm Rotary Shaft Screw.....
155c	6609	Thread Unwinder Spool Pin Set Screw for 41531 and 60697.....
157D	6609	Feed (back) Dog Screw for 62-55 Machine
159F	6609	Arm Rotary Shaft Flanged Bushing Screw
159E	6596	Looper Carrier Rock Shaft Crank Clamp- ing Screw for 38450 and 53013.....
171D	6609	Feed (front) Connecting Rod Hinge Screw Clamping Screw for 52896.....
171E	6609	Looper Bell Crank Pitman Cap (lower) Screw for 46233 and 46317.....
171E	6609	Looper Bell Crank Pitman Cap (upper) Screw for 46234 and 46318.....
171E	6609	Looper Carrier Pitman Cap (left) Screw for 46241.....
171E	6609	Looper Carrier Pitman Cap (right) Screw for 46242.....
174D	6609	Feed (front) Connecting Rod Adjusting Screw for 52897.....
175D	6596	Looper Carrier Rock Shaft Adjusting Screw for 46042 and 53012.....

NO.	PLATE	NAME
176D	6497	Arm Side Cover (upper) Screw for 62-56 and 62-57 Machines.
176D	6497	Thread (under) Nipper Spring Screw.
177C	6602	" Carrier Bell Crank Bracket Screw for 62-55 Machine.
178F	6609	Feed (back) Connecting Rod Hinge Pin Bushing Clamping Screw for 52908.
178D	6609	Feed (front) Lifting Rock Shaft Crank (front) Clamping Screw for 52905.
178F	6504	Knife Bracket Holder Clamping Screw for 46355.
181D	6609	Belt Cover Screw for 52999.
185H	6601	Needle Guard Screw for 53162.
186D	6603	Cutting Plate Bracket Screw (lower) for 52958.
190D	6603	Cutting Lever Adjusting Slide Screw for 52958.
190D	6603	Cutting Plate Bracket Screw (upper) for 52958.
190D	6601	Needle Guard Holder Screw for 62-56 and 62-57 Machines.
190D	6500	Presser Foot Screw.
190D	6599	Slack Thread Controller Clamp Screw for 62-55 Machine.
190D	6497	Thread (under) Eyelet (back) Screw.
190D	6497	" " Take-up Staple Spring Screw.
190D	6608	Thread (upper) Eyelet Screw.
191C	6504	Knife (stationary) Adjusting Lever Screw for 46356.
193F	6500	Slack Thread Controller Set Screw for 62-56 Machine.
195D	6595	Presser Bar Lifting Bracket Extension Screw for 52852.
196F	6595	Feed Eccentric Set Screw for 52907.
197D	6609	" (front) Lifting Rock Shaft Crank (front) Adjusting Screw for 52905.
203D	6504	Knife (movable) Connection Extension Screw for 62-57 Machine.
203D	6504	Knife (stationary) Stop Adjusting Screw (lower) for 46356.
203D	6504	Knife (stationary) Stop Adjusting Screw (upper) for 46356.
206F	6608	Thread (upper) Controller Screw for 62-56 and 62-57 Machines.
207F	6603	Cutting Lever Cap Screw for 52958.

NO.	PLATE	NAME
207F	6603	Cutting Plate Adjusting Slide Screw for 52958.
207D	6600	Thread Carrier Thread Eyelet (back of arm) Screw for 62-55 Machine.
207D	6599	Thread (under) Take-up Stripper Screw.
207D	6497	" " " Thread Guard (left) Screw.
207D	6497	Thread (under) Take-up Thread Guard (right) Screw.
208E	6600	Spreader Pitman Cap (back) Screw for 52868.
208E	6600	Spreader Pitman Cap (front) Screw for 52869.
208E	6600	Thread Carrier Pitman Cap (back) Screw for 52868.
208E	6600	Thread Carrier Pitman Cap (front) Screw for 52869.
208E	6600	Thread Unwinder Thread Guard Screw for 41631 and 41632.
211F	6592	Feed (front) Dog Holder Crank Clamping Screw for 52900.
211C	6592	Feed (front) Dog Screw.
211F	6592	Slack Thread Controller Set Screw for 62-57 Machine.
217D	6595	Feed Eccentric Stop Screw for 52907.
223D	6500	Thread (upper) Take-up Clamping Screw for 46312.
228D	6608	Thread (upper) Controller Screw for 62-55 Machine.
228D	6608	Thread (upper) Take-up Adjusting Screw for 62-55 Machine.
229D	6596	Looper Needle Guard Screw.
231C	6592	Feed (back) Bar Set Screw for 38425, 46332 and 52959.
237F	1105	Knife Grinder Knife Holder Stop Collar Set Screw for 27659.
240D	6605	Presser Foot Extension Screw for 52965 and 53044.
261D	1105	Cutter Grinder Cutter Regulating Thumb Screw for 27934.
261D	1105	Knife Grinder Knife Regulating Thumb Screw for 41721.
286D	4875	Arm Side Cover (lower) Thumb Screw.
286D	4875	Cloth Plate Slide (right) Thumb Screw for 52949 and 52969.
286D	4875	Cutter Grinder Cutter Holder Stop Thumb Screw for 27934.

NUMERICAL LIST OF PARTS

NO.	PLATE	NAME
286D	4875	Face Plate Thumb Screw.....
310F	1105	Cutter Grinder Cutter Holder Bracket Screw Centre for 27934.....
310F	1105	Cutter Grinder Emery Wheel Shaft Screw Centre for 27934.....
310F	1105	Knife Grinder Emery Wheel Shaft Screw Centre for 41721.....
310F	1105	Knife Grinder Knife Holder Guide Bar Bracket Screw Centre for 41721.....
335D	6500	Feed (back) Lifting Eccentric Cover Screw for 62-55 and 62-56 Machines.....
335D	6500	Looper Eccentric Cover Screw for 62-57 Machine.....
356C	6610	Rock Shaft Knee Arm Hub Set Screw for 2766.....
356C	6610	Rock Shaft Knee Plate Set Screw for 2767
356C	6610	" " Lifting Bracket Hook Set Screw for 6337.....
356C	6610	Rock Shaft Lifting Bracket Set Screw for 6337.....
356C	6610	Rock Shaft Stop Dog Set Screw for 2770.
391D	6597	Looper Shaft Screw for 62-55 and 62-56 Machines.....
391D	6597	Looper Shaft and Feed (back) Lifting Eccentric Screw for 62-57 Machine....
391E	6597	Needle Bar Connecting Stud Clamping Screw for 38460 and 46206.....
399F	6608	Arm Side Cover (upper) Screw for 62-55 Machine.....
418D	6610	Thread (upper) Retainer Screw Stud for 62-55 Machine, obsolete.....
430C	6610	Balance Wheel Set Screw for 23873.....
443C	6588	Arm Rock Shaft Crank (front) Set Screw for 38412, 52828 and 52989.....
443C	6595	Feed Eccentric Body Set Screw for 52907.
443C	6610	Looper Bell Crank Hinge Stud Set Screw.
448C	6610	Feed (front) Lifting Eccentric Set Screw for 52902.....
448C	6602	Thread Carrier Bell Crank Connection Hinge Stud (upper) Set Screw for 52828 and 52989.....
453C	6504	Knife (movable) Connection Crank Hinge Stud Set Screw for 46348.....
453C	6595	Presser Bar Lifting Bracket Set Screw for 38466 and 52852.....
453C	6504	Thread Unwinder Thread Guard Rod Set Screw for 27940.....

NUMERICAL LIST OF PARTS

NO.	PLATE	NAME
1619E	6610	Crank Connecting Rod Ball Screw Stud Nut.....
1620E	6599	Slack Thread Regulator Screw Nut.....
1636E	6610	Looper Bell Crank Pitman Ball Screw Stud (upper) Nut for 62-56 and 62-57 Machines.....
1636E	6610	Looper Carrier Pitman Ball Screw Stud (right) Nut.....
1643D	6603	Cutting Plate Adjusting Screw Thumb Nut for 52958.....
1656D	6536	Knife Grinder Knife Clamping Thumb Nut for 41719 and 41720.....
1682E	6600	Spreader Pitman Rod Nut (back) for 52862
1682E	6600	Thread Carrier Pitman Rod Nut (back) for 52862.....
1698E	6610	Tension (upper thread) Screw Stud Nut for 62-55 Machine, obsolete.....
1701C	6595	Feed (front) Regulating Stud Nut.....
1706E	6610	Looper Bell Crank Pitman Rod Nut (lower) for 46227 and 46314.....
1708E	6610	Looper Carrier Pitman Rod Nut (left) for 46236 and 46367.....
1709E	6610	Looper Carrier Pitman Rod Nut (right) for 46236 and 46367.....
1713E	6610	Looper Bell Crank Pitman Rod Nut (upper) for 46227 and 46314.....
1823	6599	Slack Thread Regulator Roller and Stud for 52569.....
2015	6597	Machine Cushion, rubber (Attachments and Accessories).....
2102	6601	Tension (thread carrier) Disc for 62-55 Machine.....
2102	6601	Tension (under thread) Disc.....
2102	6601	" (upper thread) Disc.....
2103	6601	" " " Spring for 62-56 and 62-57 Machines.....
2455	6617	Thread (upper) Retainer Disc for 62-55 Machine, obsolete.....
2763	6614	Rock Shaft for 23767.....
2766	6614	" " Knee Arm Hub with 356c, for 6336.....
2767	6614	Rock Shaft Knee Plate with 356c, for 6336.....
2770	6614	Rock Shaft Stop Dog with 356c, for 23767
4718	6608	Machine Rest, felt (Attachments and Accessories).....
4784	6608	Arm Rotary Shaft Oil Pad (felt).....

NO.	PLATE	NAME
4822	6612	Wrench for 1547 and 1698 (Attachments and Accessories)
4879	6598	Chain Connecting Link for 4885
		Nos. 4881 to 4884 for 4885.
4881	6614	Treadle
4882	6598	" Shaft
4883	6598	" Spring
4884	6614	" Stand
4885	6614	Treadle complete for 23769 and 52889, Nos. 4879, 4881 to 4884 and two wood screws 1 in. No. 16
6335	6614	Rock Shaft Knee Arm for 6336
6336	—	Rock Shaft Knee Arm complete for 23767, Nos. 2766, 2767 and 6335
6337	6614	Rock Shaft Lifting Bracket with two 356c, for 23767
6439	—	Chain, 36 in. to 45 in., for 23769 and 52889
7125	6614	Rock Shaft Lifting Bracket Hook for 23767
9533	6608	Arm Side Cover (upper) Pin
9842	6588	Machine Thumb Screw Washer for 62-55 Machine
10141	6617	Thread (upper) Retainer Spring for 62-55 Machine, obsolete
10148	6601	Tension (thread carrier) Spring for 62-55 Machine
10148	6601	Tension (under thread) Spring
10875	6612	Wrench for 1518, 1520, 1620, 1701, 1706, 1708 and 1709 (Attachments and Accessories)
11204	6504	Knife (movable) Connection Crank Hinge Stud for 62-57 Machine
11833	6536	Knife Grinder Knife Position Pin for 41719 and 41720
12242	6614	Rock Shaft Hanger with two wood screws 1 in. No. 10, for 23767
17509	6490	Arm Side Cover (lower)
17540	6598	Presser Bar for 62-57 Machine
17541	6601	" " Lifter for 62-56 and 62-57 Machines
17542	6595	Presser Bar Lifter Hinge Pin
17547	6601	Tension (thread carrier) Thread Guide for 62-55 Machine
17547	6601	Tension (under thread) Thread Guide
17547	6601	" (upper thread) Thread Guide

NO.	PLATE	NAME
18055	6608	Presser Foot Hinge Pin for 46362, 52965 and 53044
18172	6600	Thread Carrier Thread Eyelet (side of arm) for 62-55 Machine
19221	6612	Wrench for 1619 (Attachments and Accessories)
21331	6595	Feed Eccentric Pressure Spring for 52907.
21332	6595	" " " " Cap for 52907
22003	6612	Wrench for 1550 and 1682 (Attachments and Accessories)
23716	6592	Feed (back) Bar Bushing
23724	6588	Arm Rock Shaft Crank (front) Pin
23726	6592	Feed (back) Bar Hinge Pin
23759	6614	Lifting Lever for 23768 and 38385, obsolete
23760	6614	Lifting Lever Connecting Rod for 23768 and obsolete for 52890
23761	6614	Lifting Lever Spring, obsolete
23766	6612	Wrench for 1508 and 1636 (Attachments and Accessories)
23767	6614	Rock Shaft complete for 23768, 38385 and 52890, Nos. 2763, 2770, 6336, 6337, 7125 and two 12242
23768	—	Knee Lifter complete (power table) for 62-56 and 62-57 Machines, Nos. 802D, 1002D, 23760, 23767, 52521 and 53011.
23769	—	Foot Lifter complete for 62-56 and 62-57 Machines, Nos. 802D, 1002D, 4885, 6439, 52521 and 53011
*23865	—	Feed (back) Connecting Rod Cap for 38427
23866	6592	Feed (back) Connecting Rod Hinge Pin (eccentric)
23872	6490	Arm Rotary Shaft Flanged Bushing
23873	6589	Balance Wheel, 2 1/8 in. pulley, with two 430c
23907	—	Presser Foot Shank for 52965 and 53044
26026	6612	Screw Driver, large (Attachments and Accessories)
26276	6608	Presser Foot Hinge Pin for 52915 and 53170
26485	6612	Screw Driver, small (Attachments and Accessories)
27323	1105	Knife Grinder Knife Holder Guide Bar for 41721
27564	1104	Knife Grinder Frame with 27574, for 41721

NO.	PLATE	NAME
27565	1104	Cutter Grinder Emery Wheel, 2 in. diam., for 27934.....
27565	1104	Knife Grinder Emery Wheel, 2 in. diam. for 41721.....
27567	1105	Cutter Grinder Emery Wheel Shaft for 27934.....
27567	1105	Knife Grinder Emery Wheel Shaft for 41721.....
27568	1105	Cutter Grinder Emery Wheel Shaft Oil Hole Cover (rubber) for 27934.....
27568	1105	Knife Grinder Emery Wheel Shaft Oil Hole Cover (rubber) for 41721.....
27569	1105	Cutter Grinder Emery Wheel Shaft Pulley for 27934.....
27569	1105	Knife Grinder Emery Wheel Shaft Pulley for 41721.....
27572	1104	Knife Grinder Knife Holder Guide Bar Bracket with 27574, for 41721.....
27573	1105	Cutter Grinder Cutter Holder Bracket Spring for 27934.....
27573	1105	Knife Grinder Knife Holder Guide Bar Bracket Spring for 41721.....
27574	1105	Cutter Grinder Cutter Holder Bracket Spring Hook for 27925 and 27927.....
27574	1105	Knife Grinder Knife Holder Guide Bar Bracket Spring Hook for 27564 and 27572.....
27623	2837	Thread Unwinder Spool Pin for 41435 and 41531.....
27659	1105	Knife Grinder Knife Holder Stop Collar with 237F, for 41721.....
27662	1104	Wrench for 1508 and 1516 for 27934 and 41721.....
27739	2837	Thread Unwinder Thread Cone (wood) for 41438 and 41533.....
27822	1105	Cutter Grinder Emery Wheel Clamping Nut Washer for 27934.....
27822	1105	Knife Grinder Emery Wheel Clamping Nut Washer for 41721.....
Nos. 27925 TO 27933 FOR 27934.		
27925	4874	Cutter Grinder Frame with 27574.....
27926	4875	" " Cutter Holder.....
27927	4874	" " " " Bracket with 27574.....
27928	4875	Cutter Grinder Cutter Holder Clamp with 27930.....

NO.	PLATE	NAME
27929	4875	Cutter Grinder Cutter Holder Clamp Spring.....
27930	4875	Cutter Grinder Cutter Holder Clamp Steady Pin for 27928.....
27931	4875	Cutter Grinder Cutter Holder Collar with two 460c.....
27932	4875	Cutter Grinder Cutter Holder Handle... ..
27933	4875	" " " " Stop.....
27934	—	Cutter Grinder complete for 62-56 Machine, Nos. 261b, 286b, 939b, 1508c, 27565, 27567, 27569, 27573, 27662, 27822, 27925 to 27929, 27931 to 27933, two 27568, three wood screws 1 in. No. 10 and four each 310F and 1516F.....
27940	2837	Thread Unwinder Spool Stand with 453c, for 41438 and 41533.....
35095	6612	Tweezers, 6 in. (Attachments and Accessories).....
36563	6612	Oiler (copper plated) with 36564 (Attachments and Accessories).....
36564	6612	Oiler Spout, 5 in. long, with 120117, for 36563.....
36649	6613	Edge Guide, for cuffs and anklets, for 62-55 Machine.....
36650	6613	Edge Guide, for collarettes, for 62-55 Machine.....
36719	6613	Edge Guide, for collarette work, for 62-55 Machine.....
38008	6598	Needle Bar (hollow) with 857n, for 62-56 Machine.....
38022	6600	Thread Carrier Thread Eyelet (back of arm) for 62-55 Machine.....
*38127	—	Feed Eccentric for 52907.....
38152	6603	Cutting Plate Adjusting Slide for 52958... ..
38155	6603	" " Friction Plate for 52958... ..
38210	6497	Thread (under) Nipper Spring (lower)...
38211	6497	" " " " (upper)...
38225	6497	" " Eyelet (back).....
38284	6497	" " " (front).....
38329	6588	Arm Rotary Shaft Collar with two 457c..
38384	6614	Lifting Lever Connecting Rod for 38385 and 52890.....
38385	—	Knee Lifter complete (bench stand) for 62-56 and 62-57 Machines, Nos. 802b, 1002b, 23767, 38384, 52521 and 53011..
38393	6607	Looper Thread Guard for 46335.....

NUMERICAL LIST OF PARTS

NO.	PLATE	NAME
38412	6588	Arm Rock Shaft Crank (front) with 443c, for 62-56 and 62-57 Machines.....
38416	6500	Cloth Plate Slide (large) Spring for 52893
38419	6500	" " " (left) Spring for 52948..
38419	6500	" " " (small) Spring for 52834
38425	6490	Feed (back) Bar with 231c and 460c, for 62-55 Machine.....
38426	6592	Feed (back) Bar Slide Block.....
38427	6490	" " Connecting Rod with 1057E, 23865 and two 896E.....
38429	6592	Feed (back) Lifting Eccentric with two 465c, for 62-55 and 62-56 Machines.....
38432	6594	Feed Rocking Frame Bracket with two 465c.....
38433	6594	Feed Rocking Frame Hinge Pin.....
38436	6490	Looper Bell Crank Hinge Stud.....
38439	6596	" Carrier with 1143c and two 1147c, for 62-55 and 62-56 Machines.....
38440	6596	Looper Carrier Hinge Pin.....
38450	6607	" " Rock Shaft Crank (forked) with 159E, for 62-56 and 62-57 Machines and obsolete for 62-55 Machine.....
38451	6596	Looper Carrier Rock Shaft Crank Slide Block.....
38452	6596	Looper Eccentric with two 465c.....
38453	6597	" Shaft for 62-55 and 62-56 Machines
38455	6598	Needle Bar (hollow) with 857H, for 62-57 Machine.....
38456	6597	Needle Bar Bushing.....
38456	6597	Presser Bar Bushing (upper).....
38458	6607	Needle Bar Connecting Link for 62-56 and 62-57 Machines.....
38459	6607	Needle Bar Connecting Link Hinge Stud for 62-56 and 62-57 Machines and obsolete for 62-55 Machine.....
38460	6607	Needle Bar Connecting Stud with two 391E, for 62-56 and 62-57 Machines...
38466	6601	Presser Bar Lifting Bracket with 453c and 892c, for 62-56 and 62-57 Machines....
38467	6587	Presser Bar Spring (flat).....
38468	6608	" " " Stud.....
38474	6599	Slack Thread Regulator Bushing.....
38475	6497	Thread (under) Take-up with 465c, for 62-56 and 62-57 Machines.....
38476	6497	Thread (under) Take-up Thread Guard (left).....

NUMERICAL LIST OF PARTS

NO.	PLATE	NAME
38477	6497	Thread (under) Take-up Thread Guard (right).....
38478	6497	Thread (under) Take-up Staple with two each 590b and 38481, for 62-56 and 62-57 Machines.....
38481	6497	Thread (under) Take-up Staple Thread Guard for 38478.....
38482	6497	Thread (under) Take-up Stripper for 62-56 and 62-57 Machines.....
38483	6608	Thread (upper) Controller for 62-56 and 62-57 Machines.....
38487	6612	Threading Wire (Attachments and Accessories).....
40247	6504	Knife (movable) Connection Hinge Pin for 62-57 Machine.....
41434	5571	Thread Unwinder Spool Rest for 60697..
41435	—	" " " " 60697 with three 27623, for 41438.....
41438	5571	Thread Unwinder complete, for three large spools or three large cones of thread, Nos. 27940, 41435, 41632, 41640 and three each 27739, 41514 and wood screws 1 in. No. 12.....
41514	2837	Thread Unwinder Spool Weight, 4 in. diam., with 41515, for 41438 and 41533
41515	6588	Thread Unwinder Spool Weight Centre Pin for 41514.....
41530	2837	Thread Unwinder Spool Rest for 41531..
41531	—	" " " " 41530 with 1149c and two each 155c and 27623, for 41533.....
41533	2837	Thread Unwinder complete, for two large spools or two large cones of thread, Nos. 27940, 41531, 41631, 41640, two each 27739, 41514 and three wood screws 1 in. No. 12.....
41569	6601	Thread Unwinder Thread Guard Eyelet for 41631 and 41632.....
41631	2837	Thread Unwinder Thread Guard with 208E and two 41569, for 41533.....
41632	5571	Thread Unwinder Thread Guard with 208E and three 41569, for 41438.....
		Nos. 41637 to 41639 FOR 41640.
41637	2837	Thread Unwinder Thread Guard Rod (lower).....

NO.	PLATE	NAME
41638	2837	Thread Unwinder Thread Guard Rod (upper).....
41639	2837	Thread Unwinder Thread Guard Rod Coupling with two 456c.....
41640	—	Thread Unwinder Thread Guard Rod complete, 30 in. long, for 41438 and 41533, Nos. 41637 to 41639.....
41717	—	Knife Grinder Knife Holder Body for 41719.....
41718	—	Knife Grinder Knife Holder Body for 41720.....
41719	6536	Knife Grinder Knife Holder complete for 52744 for 41721, Nos. 38d, 574d, 1528n, 1656b, 11833 and 41717.....
41720	6536	Knife Grinder Knife Holder complete for 46351 for 41721, Nos. 38d, 574d, 1528n, 1656b, 11833 and 41718.....
41721	—	Knife Grinder complete for 46351 and 52744, for 62-57 Machine, Nos. 261d, 1508c, 27323, 27564, 27565, 27567, 27569, 27572, 27573, 27659, 27662, 27822, 41719, 41720, two 27568, three wood screws 1 in. No. 10 and four each 310F and 1516F.....
42088	6608	Machine Cushion (felt) for 52999.....
46034	6599	Slack Thread Controller for 62-55 Machine
46035	6599	“ “ “ Clamp for 62-55 Machine.....
46040	6594	Thread (under) Take-up Staple Bracket with 910c.....
46041	6497	Thread (under) Take-up Staple Spring... ..
46042	6607	Looper Carrier Rock Shaft with two 175d, for 62-56 and 62-57 Machines and obsolete for 62-55 Machine.....
46043	6596	Looper Carrier Rock Shaft Hinge Pin... ..
46049	6497	Thread (under) Nipper Cam with 465c... ..
46051	6598	Needle Bar for 62-55 Machine.....
46087	—	Presser Foot Shank for 52915 and 53170.....
46092	6598	“ Bar for 62-56 Machine.....
46105	6596	Looper Needle Guard Pin for 52661, 52845 and 52910.....
46111	6608	Face Plate Pin.....
46113	6500	Feed (back) Lifting Eccentric Cover for 62-55 Machine.....
46145	6587	Looper Bell Crank with 1259c, for 62-55 Machine.....
46169	6500	Slack Thread Controller for 62-57 Machine

NO.	PLATE	NAME
46176	6587	Looper Carrier Pitman Rod for 46367....
46179	6490	Face Plate.....
46205	6597	Needle Bar Connecting Link for 62-55 Machine.....
46206	6597	Needle Bar Connecting Stud with two 391E, for 62-55 Machine.....
46211	6599	Thread (under) Take-up Staple for 62-55 Machine.....
46216	6490	Arm Rock Shaft for 62-56 and 62-57 Machines.....
46217	6588	Arm Rock Shaft Crank (back) with two 1497c, for 62-56 and 62-57 Machines... ..
46221	6490	Crank Connecting Rod with 46222, 46223 and two each 896E and 1057E, for 62-56 and 62-57 Machines and obsolete for 62-55 Machine.....
*46222	—	Crank Connecting Rod Cap (lower) for 46221.....
*46223	—	Crank Connecting Rod Cap (upper) for 46221 and 52990.....
46225	6597	Crank Connecting Rod Washer (fibre)... ..
46226	6490	Looper Bell Crank with 1037c, for 62-56 and 62-57 Machines.....
46227	6587	Looper Bell Crank Pitman complete for 62-56 and 62-57 Machines, Nos. 1706E, 1713E and 46233 to 46235.....
46228	6596	Looper Bell Crank Pitman Ball Stud (lower) for 46233 and 46317.....
*46229	—	Looper Bell Crank Pitman Cap (lower) for 46233 and 46317.....
*46230	—	Looper Bell Crank Pitman Cap (upper) for 46234 and 46318.....
*46231	—	Looper Bell Crank Pitman End Bearing (lower) for 46233.....
*46232	—	Looper Bell Crank Pitman End Bearing (upper) for 46234.....
Nos. 46233 to 46235 for 46227.		
46233	6587	Looper Bell Crank Pitman Head (lower) Nos. 46228, 46229, 46231 and two 171E
46234	6587	Looper Bell Crank Pitman Head (upper) Nos. 46230, 46232, 50070c and two 171E
46235	6587	Looper Bell Crank Pitman Rod.....
46236	6615	Looper Carrier Pitman complete, Nos. 1708E, 1709E and 46241 to 46243, obsolete, use 46367.....

NUMERICAL LIST OF PARTS

NO.	PLATE	NAME
46237	6596	Looper Carrier Pitman Ball Stud (left) for 46241.....
*46238	—	Looper Carrier Pitman Cap (left) for 46241.....
*46238	—	Looper Carrier Pitman Cap (right) for 46242.....
*46239	—	Looper Carrier Pitman End Bearing (left) for 46241.....
*46240	—	Looper Carrier Pitman End Bearing (right) for 46242.....
46241	6587	Looper Carrier Pitman Head (left) for 46236 and 46367, Nos. 46237 to 46239 and two 171E.....
46242	6587	Looper Carrier Pitman Head (right) for 46236 and 46367, Nos. 46238, 46240, 50070c and two 171E.....
46243	6615	Looper Carrier Pitman Rod for 46236, obsolete, use 46176.....
46244	6601	Looper Bell Crank Pitman Washer (fibre) for 62-55 Machine.....
46244	6601	Looper Carrier Pitman Washer (fibre)...
46247	6497	Thread (under) Nipper Spring (upper) Stop.....
46312	6500	Thread (upper) Take-up with 223D, for 62-56 and 62-57 Machines.....
46314	6587	Looper Bell Crank Pitman complete for 62-55 Machine, Nos. 1706E, 1713E and 46317 to 46319.....
*46315	—	Looper Bell Crank Pitman End Bearing (lower) for 46317.....
*46316	—	Looper Bell Crank Pitman End Bearing (upper) for 46318.....
Nos. 46317 to 46319 FOR 46314.		
46317	6587	Looper Bell Crank Pitman Head (lower) Nos. 46228, 46229, 46315 and two 171E.....
46318	6587	Looper Bell Crank Pitman Head (upper) Nos. 46230, 46316, 50081c and two 171E.....
46319	6587	Looper Bell Crank Pitman Rod.....
46327	6603	Cutting Lever Cap for 52958.....
46332	6595	Feed (back) Bar with 231c, for 62-57 Machine.....
46335	6607	Looper with 590D and 38393, for 62-56 and 62-57 Machines.....
46336H	6500	Feed (back) Lifting Eccentric Cover for 62-56 Machine.....
46336H	6500	Looper Eccentric Cover for 62-57 Machine

NUMERICAL LIST OF PARTS

NO.	PLATE	NAME
46338	6597	Presser Bar Bushing (lower) for 62-55 and 62-56 Machines.....
46343	6589	Arm Rotary Shaft for 62-57 Machine....
Nos. 46347 TO 46349 FOR 62-57 MACHINE.		
46347	6504	Knife (movable) Connection Crank.....
46348	6504	“ “ “ Bracket with 453c.....
46349	6504	Knife (movable) Connection Extension..
46351	6504	“ (stationary) for 46356.....
46352	6504	“ “ Adjusting Lever for 46356.....
46355	6504	Knife Bracket Holder with two 178E, for 62-57 Machine.....
46356	—	Knife Bracket complete for 62-57 Machine, Nos. 191c, 1042c, 1250E, 1554E, 46351, 46352, 52659, 52660, 52744 and two 203D.....
46359	6601	Presser Bar Bushing (lower) for 62-57 Machine.....
46360	—	Presser Foot Plate for 46362.....
46361	—	“ “ Shank for 46362.....
46362	6606	Presser Foot (hinged) complete for 62-57 Machine, Nos. 18055, 46360 and 46361.
46364	6588	Arm Rock Shaft Crank (back) with two 1497c, for 62-55 Machine.....
46365	6589	Arm Rotary Shaft for 62-55 Machine....
46367	6587	Looper Carrier Pitman complete, Nos. 1708E, 1709E, 46176, 46241 and 46242.
46371	6587	Arm Rock Shaft for 62-55 Machine.....
46439	6592	Feed (back) Connecting Rod Hinge Pin Bushing.....
*46445	—	Feed (front) Lifting Rock Shaft Bracket for 52891, 52944, 52968 and 52988.....
46447	6594	Feed (front) Lifting Rock Shaft Crank (back) Slide Block.....
46449	6595	Feed (front) Regulating Stud Sleeve.....
46463H	6591	Cloth Plate Slide (right) with 1602H, for 52969.....
49092	6608	Arm Oil Tube Packing (felt) for 52630..
50062D	6599	Slack Thread Regulator Screw.....
50069c	6610	Crank Connecting Rod Ball Screw Stud..
50070c	6610	Looper Bell Crank Pitman Ball Screw Stud (upper) for 46234.....
50070c	6610	Looper Carrier Pitman Ball Screw Stud (right) for 46242.....

NUMERICAL LIST OF PARTS

NO.	PLATE	NAME
50081c	6610	Looper Bell Crank Pitman Ball Screw Stud (upper) for 46318.....
50109F	6610	Feed (front) Bar Hinge Screw.....
50110c	6595	" " Regulating Stud.....
50114D	6603	Cutting Lever Connecting Link Hinge Screw (lower) for 62-56 Machine.....
50148F	6601	Tension (upper thread) Screw Stud for 62-55 Machine.....
52521	6614	Lifting Lever Spring for 23768, 23769, 38385, 52889 and 52890.....
52553	6597	Looper Shaft Bracket for 62-55 and 62-56 Machines.....
52553	6597	Looper Shaft and Feed (back) Lifting Eccentric Bracket for 62-57 Machine..
52554	6490	Arm Side Cover (upper) for 62-56 and 62-57 Machines.....
52569	6599	Slack Thread Regulator Bracket with 704c and 1823.....
52626	6599	Slack Thread Regulator for 62-56 and 62-57 Machines.....
52627	6608	Thread (upper) Eyelet for 62-56 and 62-57 Machines.....
52630	6608	Arm Oil Tube with 49092, for oiling 46221 and 52990.....
52631H	6591	Cloth Plate Slide (right) with 1602H, for 52949.....
52659	6504	Knife (stationary) Stop for 46356.....
52660	6504	" Bracket for 46356.....
52661	6500	Looper Needle Guard with 46105, for 62-56 and 62-57 Machines.....
52673	6616	Needle Guard for 62-57 Machine, obsolete, use 53162.....
Nos. 52741 to 52743 FOR 62-57 MACHINE.		
52741	6504	Knife (movable) Connection with 904c...
52742	6504	" " Eccentric with two 457c
52743	6607	Looper Shaft and Feed (back) Lifting Eccentric.....
52744	6504	Knife (movable) with 52745 and two 1053D, for 46356.....
52745	6504	Knife (movable) Chip Ejector for 52744.
52780	6603	Cutting Lever for 52958.....
52781	6617	" Plate for 52958, obsolete, use 53122.....
52784	6607	Looper Carrier with 1143c and two 1147c, for 62-57 Machine.....

NUMERICAL LIST OF PARTS

NO.	PLATE	NAME
52828	6617	Arm Rock Shaft Crank (front) with 443c and 448c, for 62-55 Machine, obsolete.
52829	6587	Arm Side Cover (upper) for 62-55 Machine
52830	6590	Cloth Plate for 52894.....
52833	—	" " Slide (small) for 52834.....
52834	6591	Cloth Plate Slide (small) complete for 52894, Nos. 38419, 52833 and two 725H
52836	6615	Face Plate for 62-55 Machine, obsolete...
52844	6596	Looper with 590D and 52846, for 62-55 Machine.....
52845	6596	Looper Needle Guard with 46105, for 62-55 Machine.....
52846	6596	Looper Thread Guard for 52844 and 52909
Nos. 52850 to 52853 FOR 62-55 MACHINE.		
52850	6598	Presser Bar.....
52851	6595	" " Lifter.....
52852	6595	" " Lifting Bracket with 195D, 453c, 892c and 52853.....
52853	6595	Presser Bar Lifting Bracket Extension for 52852.....
52859	6600	Spreader for 62-55 Machine.....
52860	6617	" Holder with 857H and 1253c, for 62-55 Machine, obsolete.....
52861	6600	Spreader Holder Hinge Stud for 62-55 Machine.....
52861	6600	Thread Carrier Holder Hinge Stud for 62-55 Machine.....
52862	6602	Spreader Pitman complete for 62-55 Machine, Nos. 1550H, 1682E and 52868 to 52870.....
52862	6602	Thread Carrier Pitman complete for 52881, Nos. 1550H, 1682E and 52868 to 52870.
52863	6600	Spreader Pitman Ball Stud (front) for 52869.....
52863	6600	Thread Carrier Pitman Ball Stud (front) for 52869.....
*52864	—	Spreader Pitman Cap (back) for 52868...
*52864	—	Thread Carrier Pitman Cap (back) for 52868.....
*52865	—	Spreader Pitman Cap (front) for 52869...
*52865	—	Thread Carrier Pitman Cap (front) for 52869.....
*52866	—	Spreader Pitman End Bearing (back) for 52868.....
*52866	—	Thread Carrier Pitman End Bearing (back) for 52868.....

NUMERICAL LIST OF PARTS

NO.	PLATE	NAME
*52867	—	Spreader Pitman End Bearing (front) for 52869.....
*52867	—	Thread Carrier Pitman End Bearing (front) for 52869.....
Nos. 52868 TO 52870 FOR 52862.		
52868	6602	Spreader Pitman Head (back) Nos. 52864, 52866 and two 208E.....
52868	6602	Thread Carrier Pitman Head (back) Nos. 52864, 52866 and two 208E.....
52869	6602	Spreader Pitman Head (front) Nos. 52863, 52865, 52867 and two 208E.....
52869	6602	Thread Carrier Pitman Head (front) Nos. 52863, 52865, 52867 and two 208E.....
52870	6602	Spreader Pitman Rod.....
52870	6602	Thread Carrier Pitman Rod.....
Nos. 52871 TO 52881 FOR 62-55 MACHINE.		
52871	6600	Thread Carrier.....
52872	6617	" " Bell Crank with three 462c, obsolete.....
52873	6617	Thread Carrier Bell Crank Bracket, obsolete.....
52874	6602	Thread Carrier Bell Crank Connection
52875	6602	" " " " " " Hinge Stud (lower).....
52876	6602	Thread Carrier Bell Crank Connection Hinge Stud (upper).....
52877	6602	Thread Carrier Bell Crank Hinge Stud...
52878	6617	" " Holder with 857H and 1253c, obsolete.....
52879	6600	Thread Carrier Holder Bracket with four 1253c.....
52880	6602	Thread Carrier Pitman Ball Stud (back, double) for 52881.....
52881	—	Thread Carrier Pitman Ball Stud (back, double) 52880 with two 52862.....
52883	6616	Thread (under) Take-up Staple for 62-55 Machine, obsolete.....
52888	6614	Lifting Lever for 52889 and 52890, obsolete.....
52889	—	Foot Lifter complete for 62-55 Machine, Nos. 802D, 1002D, 4885, 6439, 52521 and 53010.....
52890	—	Knee Lifter complete for 62-55 Machine, Nos. 802D, 1002D, 23767, 38384, 52521 and 53010.....

NUMERICAL LIST OF PARTS

NO.	PLATE	NAME
*52891	—	Arm, upper and lower (solid) with 129E, 965D and 46445, for 62-55 Machine, obsolete.....
52892	—	Cloth Plate Slide (large) for 52893.....
52893	6591	Cloth Plate Slide (large) complete for 52894, Nos. 52892, two 38416 and four 725H.....
52894	—	Cloth Plate complete for 62-55 Machine, Nos. 52830, 52834 and 52893.....
52895	6616	Feed (back) Dog for 62-55 Machine, obsolete.....
52896	6594	Feed (front) Bar with 171D.....
52897	6594	" " Connecting Rod with two 174D.....
52898	6593	Feed (front) Dog for 62-55 Machine.....
52899	6592	" " " Holder.....
52900	6592	" " " " Crank with 211F.....
52901	6592	" " " " " " Connect- ing Link.....
52902	6594	Feed (front) Lifting Eccentric with two 448c.....
52903	6587	Feed (front) Lifting Rock Shaft.....
52904	6594	" " " " " Crank (back) forked, with 647D.....
52905	6594	Feed (front) Lifting Rock Shaft Crank (front) with two each 178D and 197D...
*52906	—	Feed Eccentric Body for 52907.....
52907	6595	Feed Eccentric (adjustable) complete, Nos. 196F, 217D, 934D, 1103c, 21331, 21332, 38127, 52906 and two 443c.....
52908	6594	Feed Rocking Frame with 178F.....
52909	6617	Looper with 590D and 52846, for 62-55 Machine, obsolete.....
52910	6617	Looper Needle Guard with 46105, for 62-55 Machine, obsolete.....
52911	6597	Needle Clamp with three 904F, for 62-55 Machine.....
52912	6597	Needle Clamp Thread Retainer for 62-55 Machine.....
52913	—	Presser Foot Plate for 52915, obsolete...
Nos. 52915 TO 52919 FOR 62-55 MACHINE, OBSOLETE.		
52915	6616	Presser Foot (hinged) complete, Nos. 26276, 46087 and 52913.....
52916	6615	Slack Thread Regulator, use 52994.....
52917	6615	Tension (upper thread) Bracket.....
52918	6616	Thread (under) Take-up with 465C.....

NUMERICAL LIST OF PARTS

NO.	PLATE	NAME
52919	6617	Thread (under) Take-up Stripper.....
52920	6608	" (upper) Controller for 62-55 Machine.....
52921	6608	Thread (upper) Eyelet for 62-55 Machine
52922	6615	" " Retainer Bracket for 62-55 Machine, obsolete.....
52923	6608	Thread (upper) Take-up for 62-55 Machine.....
52924	6616	Throat Plate for 52895 and 52898, obsolete.....
*52944	—	Arm, upper and lower (solid) with 129E, 965D and 46445, for 62-56 Machine....
52945	6589	Arm Rotary Shaft for 62-56 Machine....
52946	6590	Cloth Plate for 52949 and 52969.....
52947H	—	" " Slide (left) for 52948.....
52948	6591	Cloth Plate Slide (left) complete for 52949 and 52969, Nos. 38419, 52947H and two 725H.....
52949	—	Cloth Plate complete for 62-56 Machine, Nos. 286D, 52631H, 52946 and 52948...
52950	6603	Cutting Lever Adjusting Slide for 52958.
Nos. 52951 TO 52967 FOR 62-56 MACHINE.		
52951	6603	Cutting Lever Connecting Link.....
52952	6604	" " Eccentric with two 457C...
52953	6604	" " " Connection.....
52954	6604	" " " " Lever
52955	6604	" " " " " "
Bracket.....		
52956	6603	Cutting Plate Bracket for 52958.....
52957	6604	" " " Holder for 52958...
52958	—	Cutting Plate Bracket complete, Nos. 87F, 1246C, 1389F, 1643D, 38152, 38155, 46327, 52780, 52950, 52956, 52957, 53122, two each 186D, 190D, 1247C and four 207F.....
52959	6592	Feed (back) Bar with 231C.....
52960	6605	" " Dog.....
52961	6605	" (front) Dog.....
52962	6617	Needle Guard, obsolete, use 53162.....
52963	6616	Presser Foot Extension for 52965, obsolete
52964	—	" " Plate for 52965, obsolete....
52965	6616	Presser Foot (hinged) complete, Nos. 240D, 18055, 23907, 52963 and 52964, obsolete, use 53044.....
52966	6607	Slack Thread Controller.....
52967	6605	Throat Plate for 52960 and 52961.....

NUMERICAL LIST OF PARTS

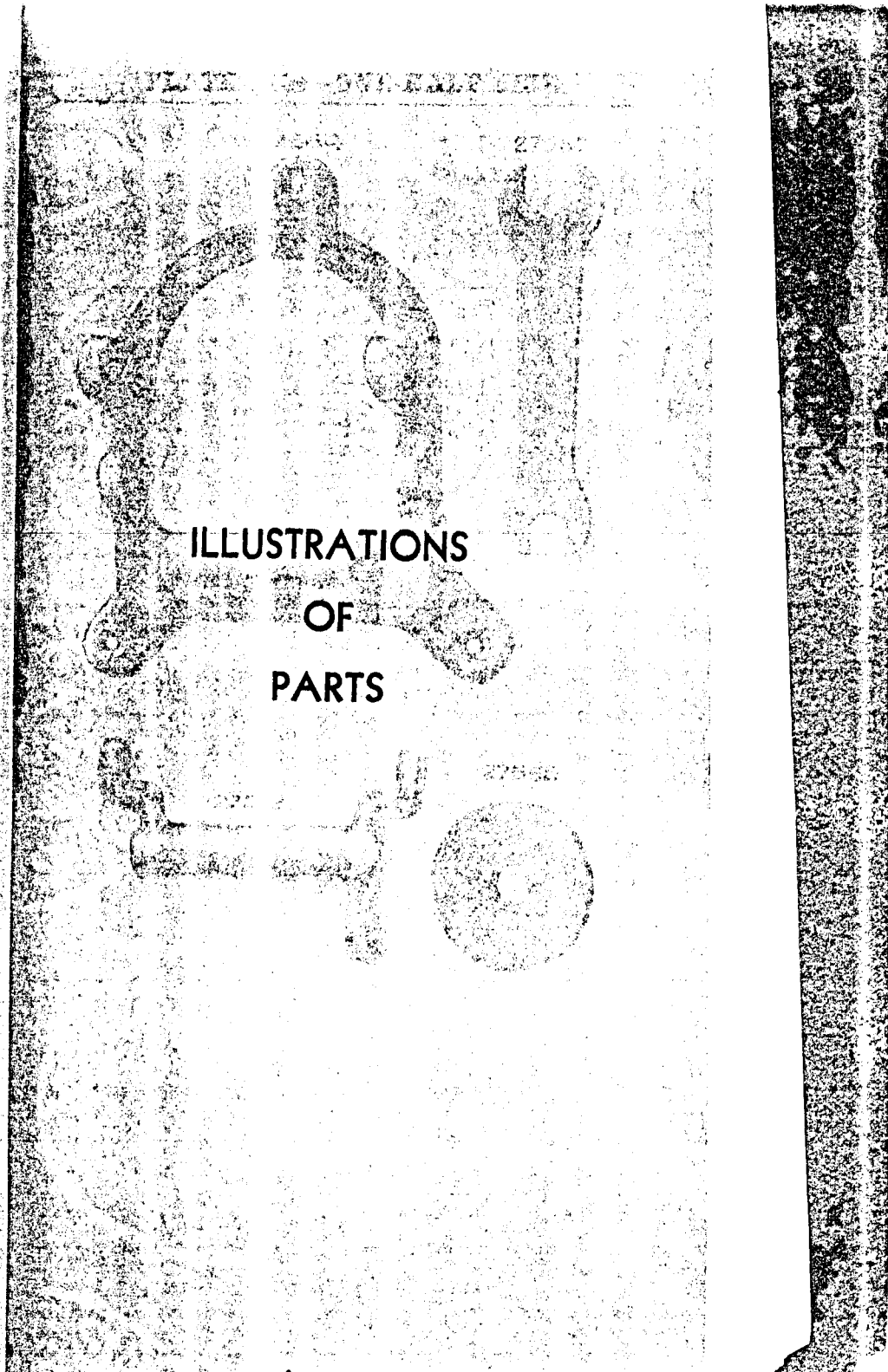
NO.	PLATE	NAME
Nos. 52968 TO 52972 FOR 62-57 MACHINE.		
*52968	—	Arm, upper and lower (solid) with 129E, 965D and 46445.....
52969	—	Cloth Plate complete, Nos. 286D, 46463H, 52946 and 52948.....
52970	6606	Feed (back) Dog.....
52971	6606	" (front) Dog.....
52972	6606	Throat Plate for 52970 and 52971.....
Nos. 52988 TO 52992 FOR 62-55 MACHINE.		
*52988	—	Arm, upper and lower (solid) with 129E, 965D and 46445.....
52989	6588	Arm Rock Shaft Crank (front) with 443C and 448C.....
52990	6587	Crank Connecting Rod with 46223, 52991 and two each 896E and 1057E.....
*52991	—	Crank Connecting Rod Cap (lower) for 52990.....
52992	6597	Needle Bar Connecting Link Hinge Stud
Nos. 52994 TO 53000 FOR 62-55 MACHINE.		
52994	6599	Slack Thread Regulator.....
52995	6600	Spreader Holder with 857H and 1253C...
52996	6602	Thread Carrier Bell Crank with three 462C
52997	6602	" " " " Bracket.....
52998	6600	" " Holder with 857H and 1253C.....
52999	6589	Machine Base with 53119, two each 181D, wood screws 1¼ in. No. 12 and four each 131D, 42088 and 53000.....
53000	6608	Machine Cushion (leather) for 52999....
53009	6588	" Thumb Screw Spring for 62-55 Machine.....
53010	6614	Lifting Lever for 52889 and 52890.....
53011	6614	" " " 23768, 23769 and 38385
53012	6596	Looper Carrier Rock Shaft with two 175D, for 62-55 Machine.....
53013	6596	Looper Carrier Rock Shaft Crank (forked) with 159E, for 62-55 Machine.....
53042	6605	Presser Foot Extension for 53044.....
53043	—	" " Plate for 53044.....
53044	6605	Presser Foot (hinged) complete for 62-56 Machine, Nos. 240D, 18055, 23907, 53042 and 53043.....
53119	6589	Belt Cover for 52999.....
53122	6603	Cutting Plate for 52958.....

NUMERICAL LIST OF PARTS

NO.	PLATE	NAME
53160	6601	Needle Guard for 53162.....
53161	6601	" " Holder for 53162.....
53162	—	Needle Guard complete for 62-56 and 62-57 Machines, Nos. 185H, 53160 and 53161.....
53168	6593	Feed (back) Dog for 62-55 Machine.....
53169	—	Presser Foot Plate for 53170.....
53170	6593	Presser Foot (hinged) complete for 62-55 Machine, Nos. 26276, 46087 and 53109.
53171	6599	Thread (under) Take-up with 465c, for 62-55 Machine.....
53172	6599	Thread (under) Take-up Stripper for 62-55 Machine.....
53173	6593	Throat Plate for 52898 and 53168.....
54716	6597	Needle Clamp Thread Retainer Spring for 62-55 Machine.....
54883	6601	Tension (upper thread) Spring for 62-55 Machine.....
*60697	—	Thread Unwinder Spool Rest 41434 with 1149c and three 155c, for 41435.....
120117	6612	Oiler Spout Washer (leather) for 36564..

SINGER Needles should be used
in SINGER Machines.
These Needles and their Containers
are marked with the
Company's Trade Mark "SIMANCO."* 1

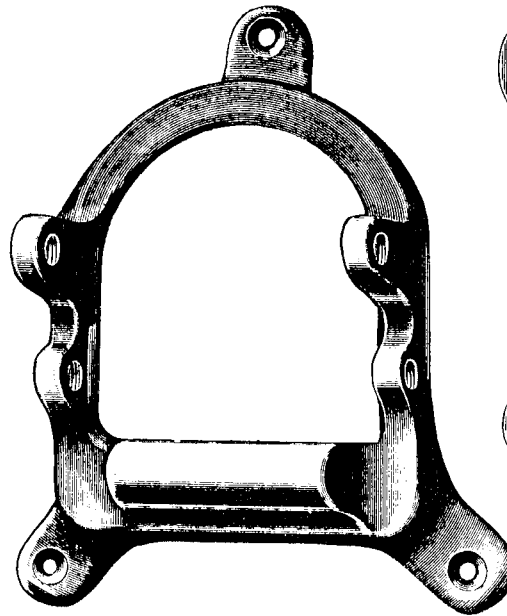
Needles in Containers marked
"FOR SINGER MACHINES"
are NOT **SINGER** made needles. 2



ILLUSTRATIONS
OF
PARTS

PLATE 1104—ONE-HALF SIZE

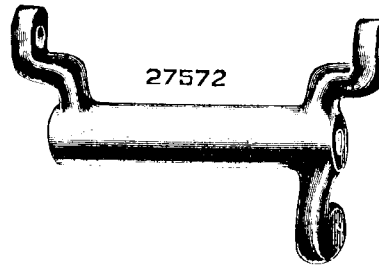
27564



27662



27572



27565

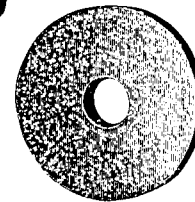


PLATE 1105—FULL SIZE

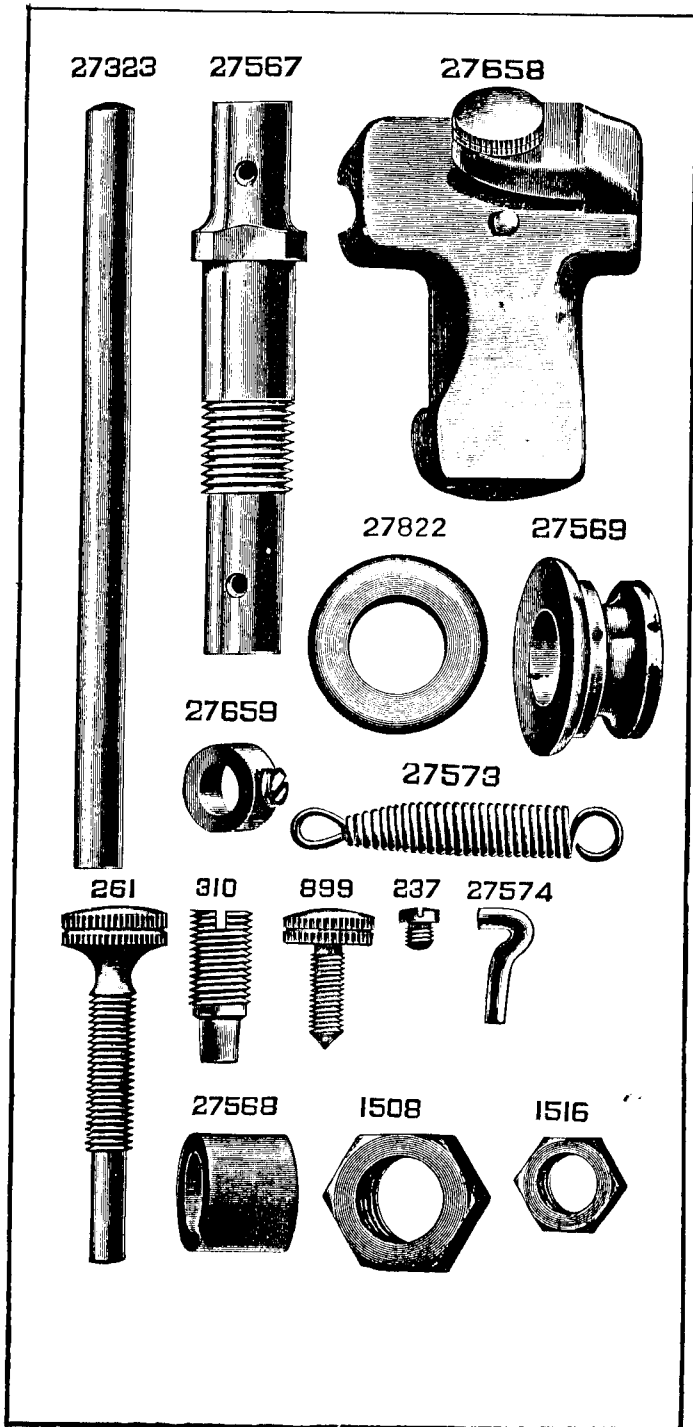


PLATE 2837—ONE-FOURTH SIZE

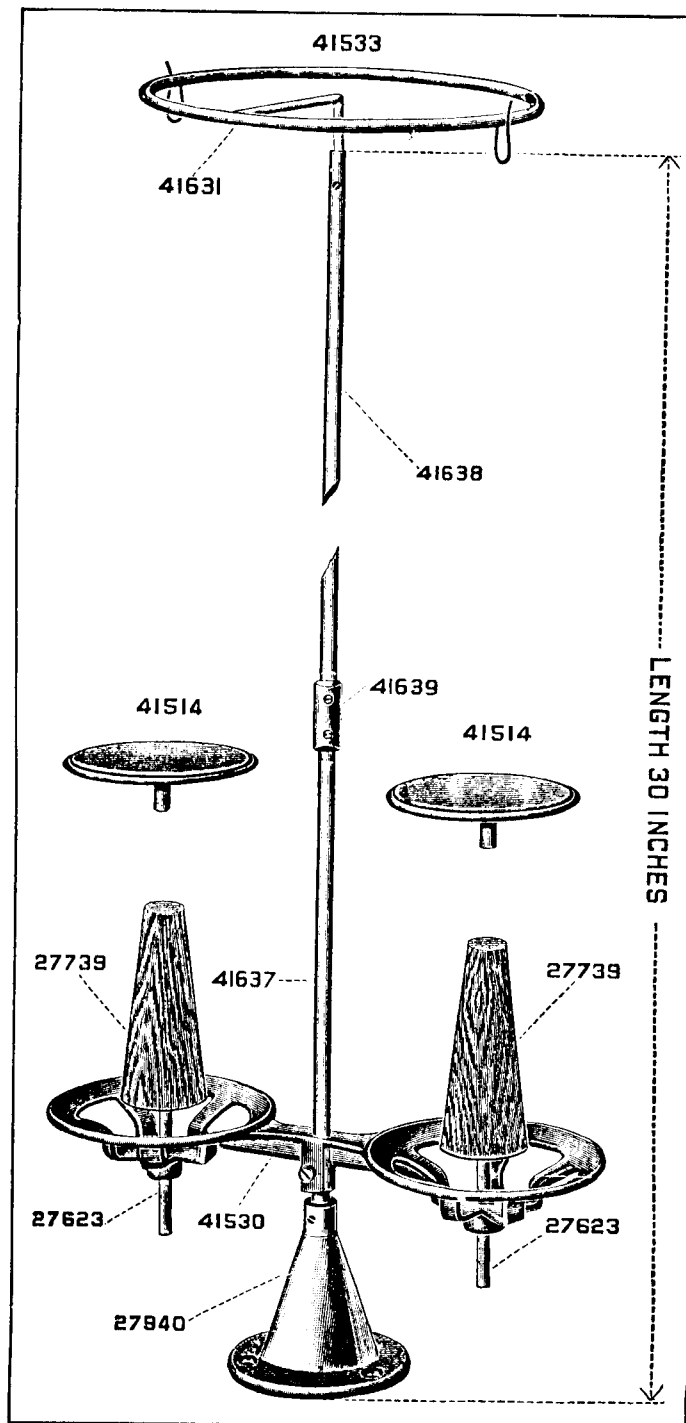
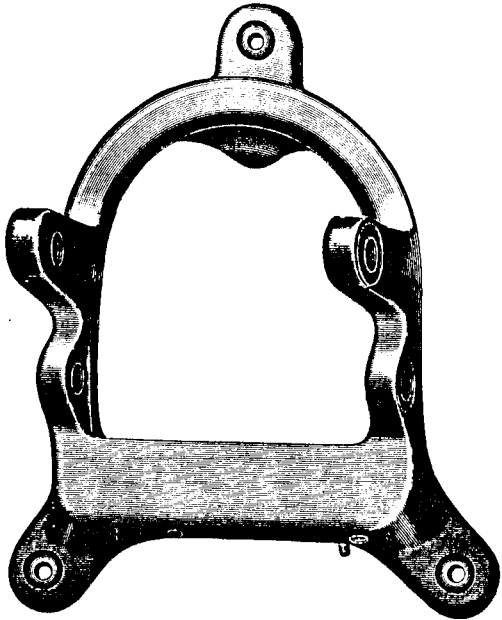


PLATE 4874—ONE-HALF SIZE

27925



27927

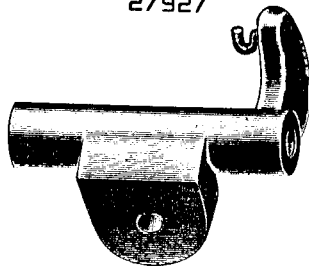
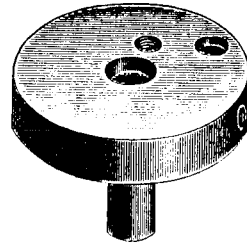


PLATE 4875—FULL SIZE

27926



27928



27929



27930



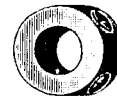
27932



939



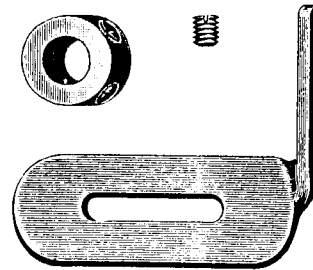
27931



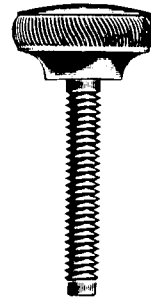
460



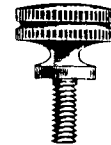
27933



574



286



432



PLATE 5571—ONE-FOURTH SIZE

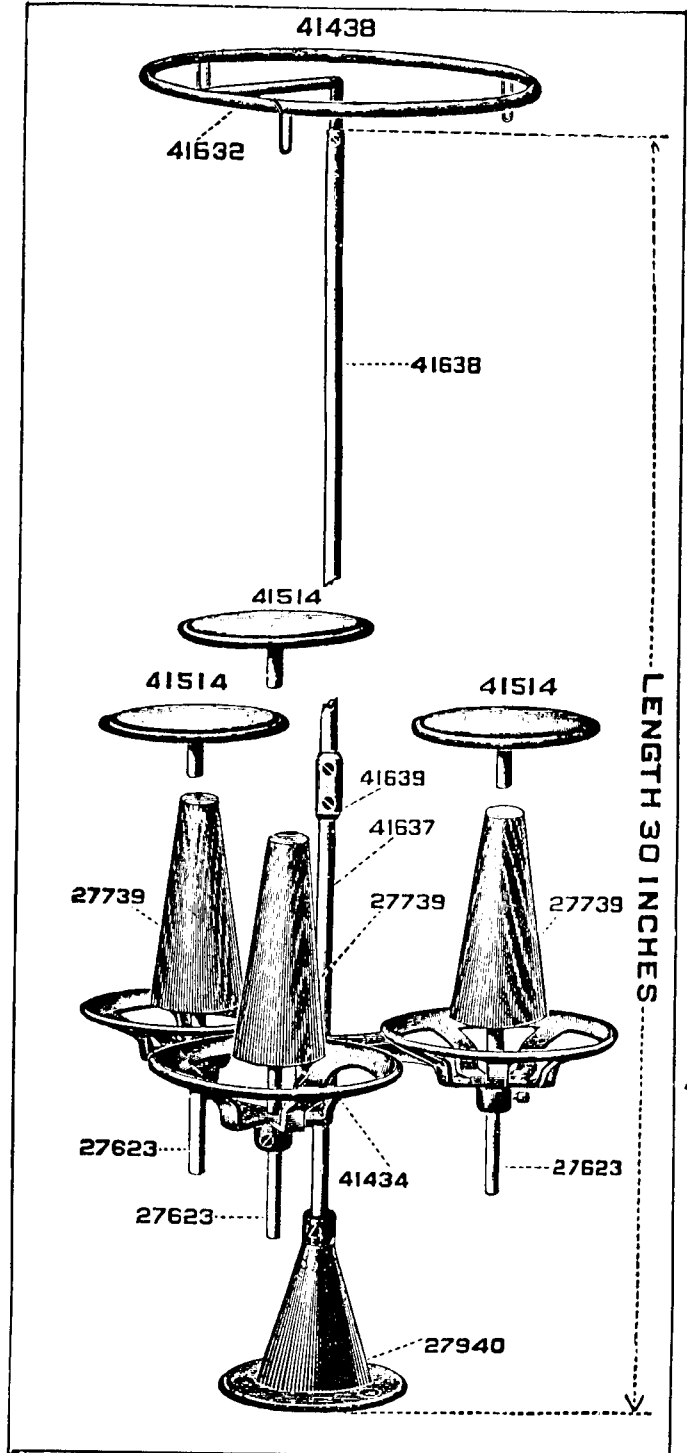


PLATE 6490—ONE-HALF SIZE

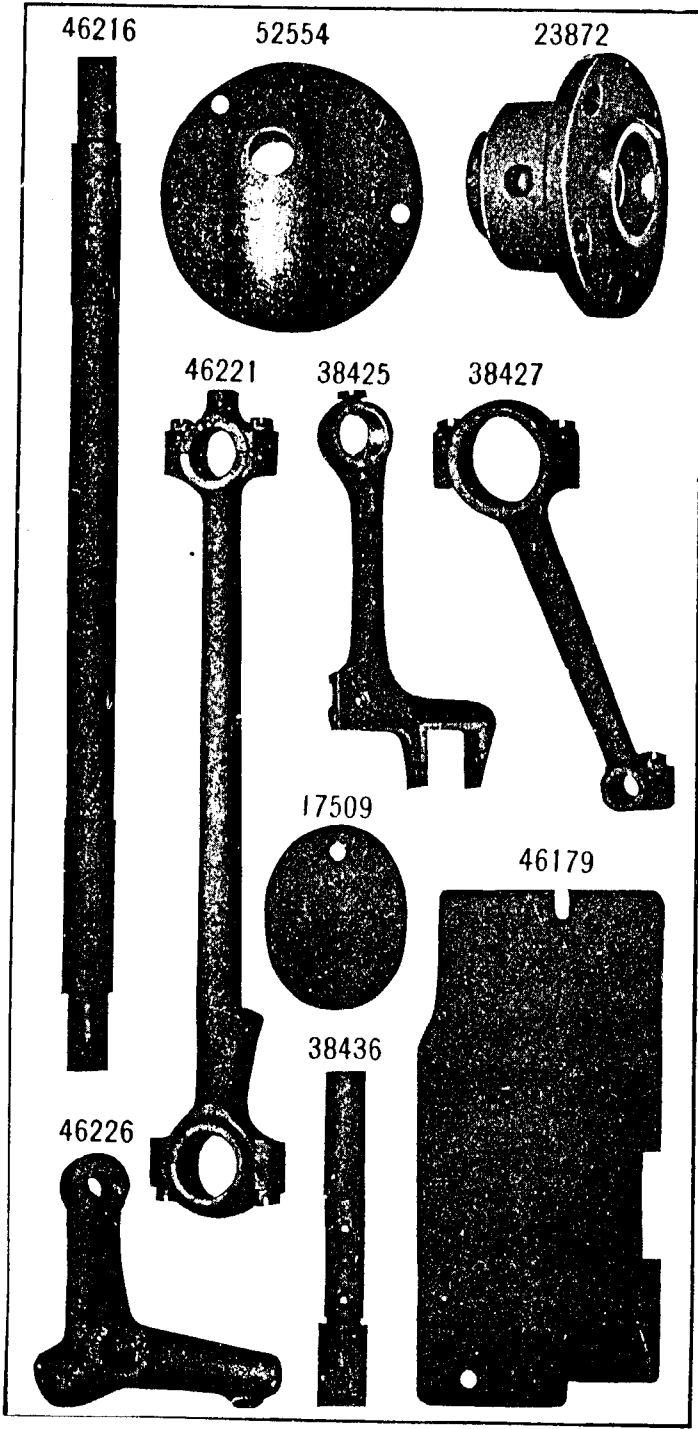


PLATE 6497—FULL SIZE

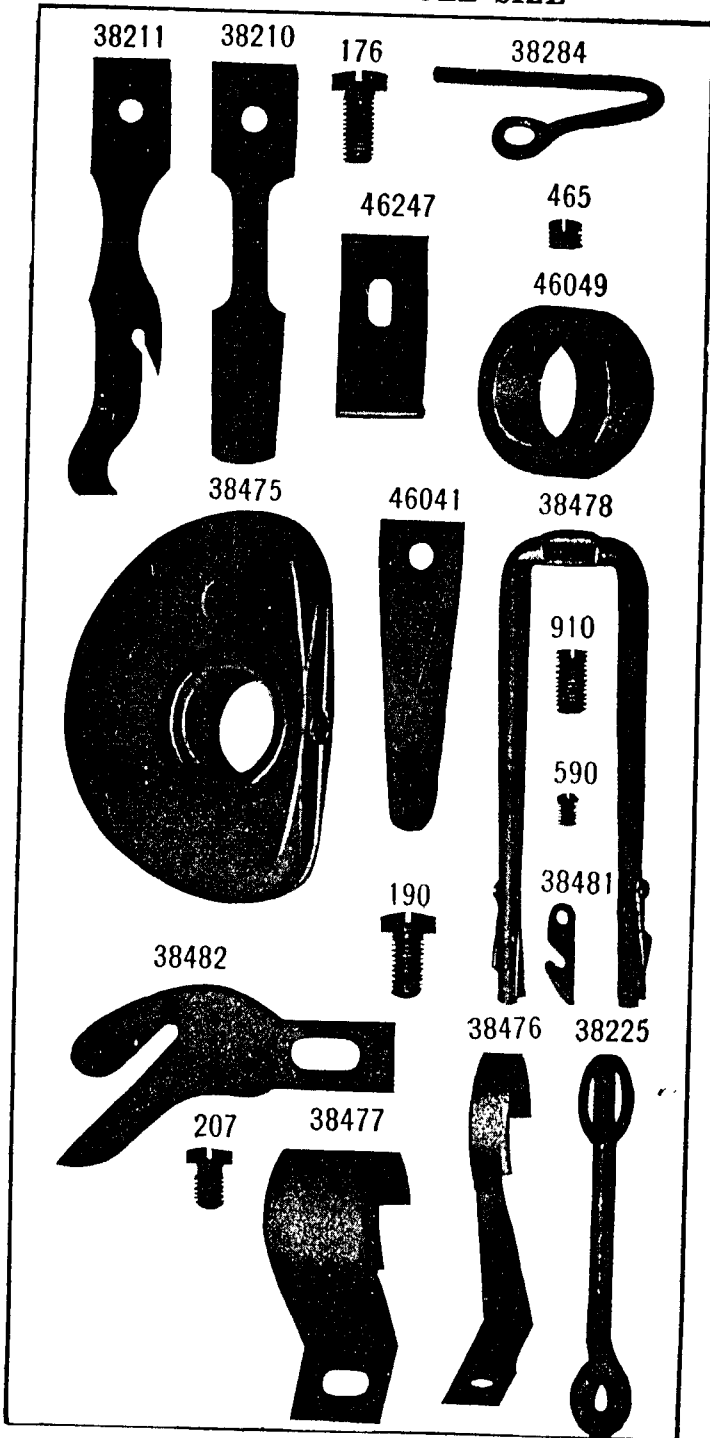


PLATE 6500—FULL SIZE

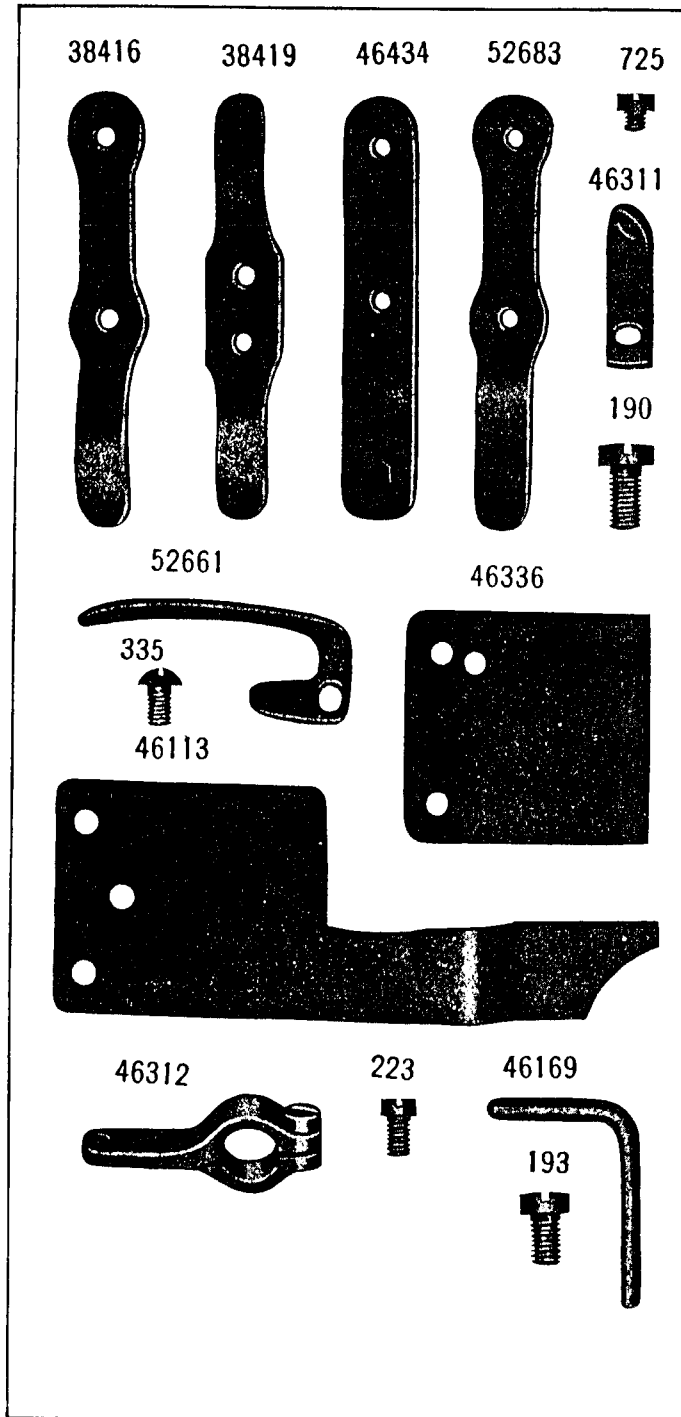


PLATE 6504—FULL SIZE

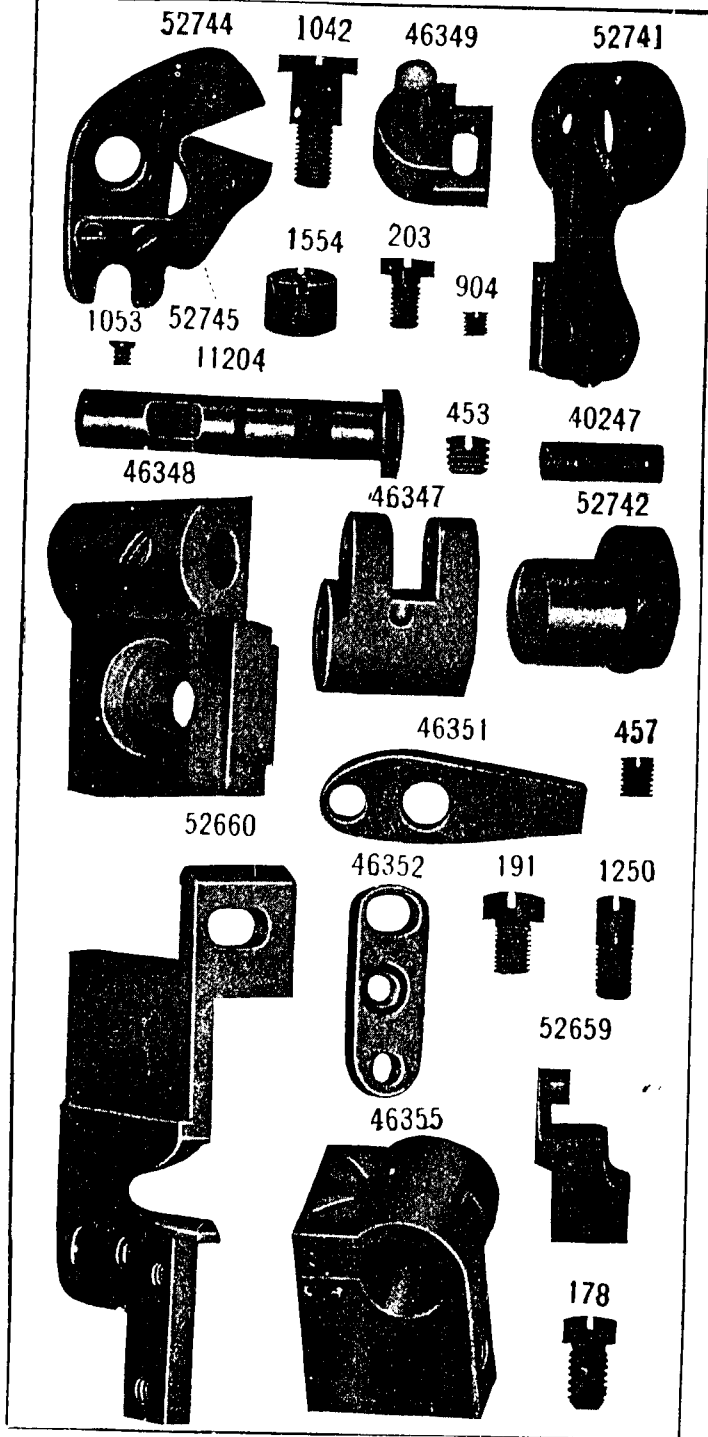


PLATE 6536—FULL SIZE

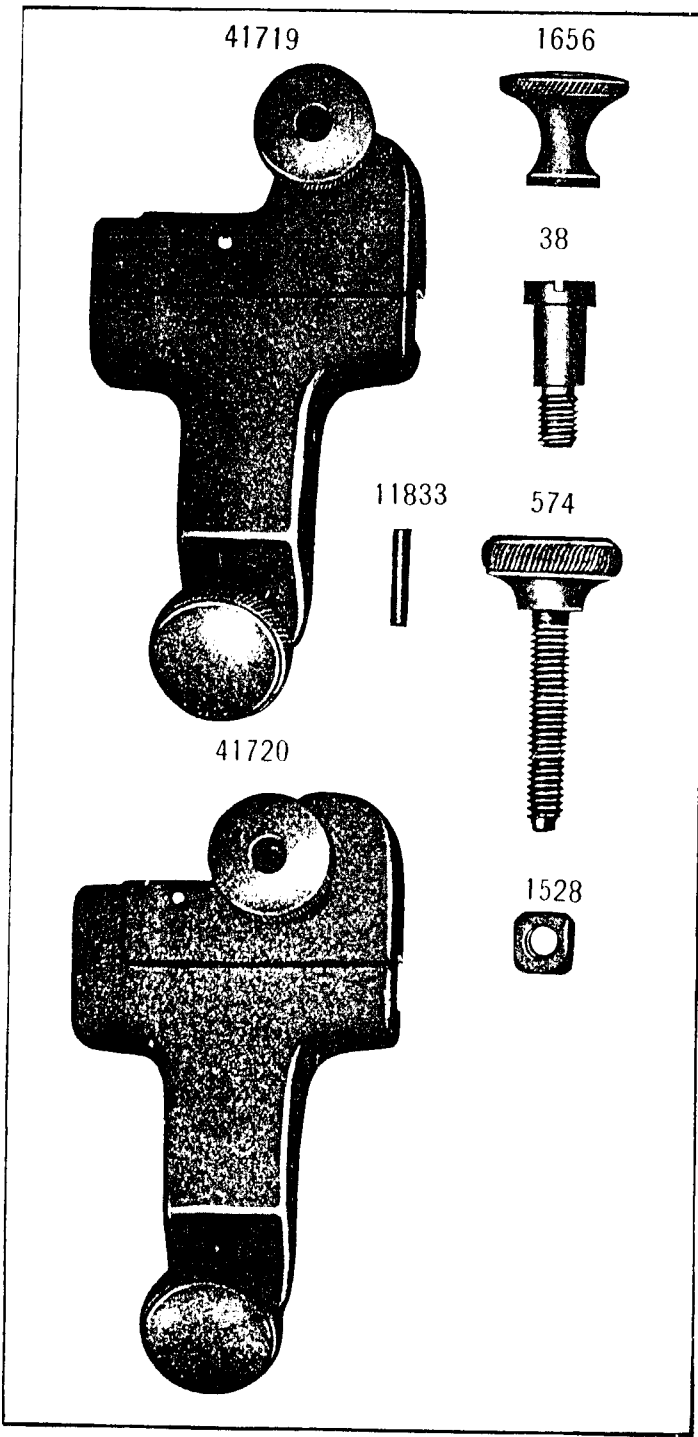


PLATE 6587—ONE-HALF SIZE

46371 52903 46314 46367 38467

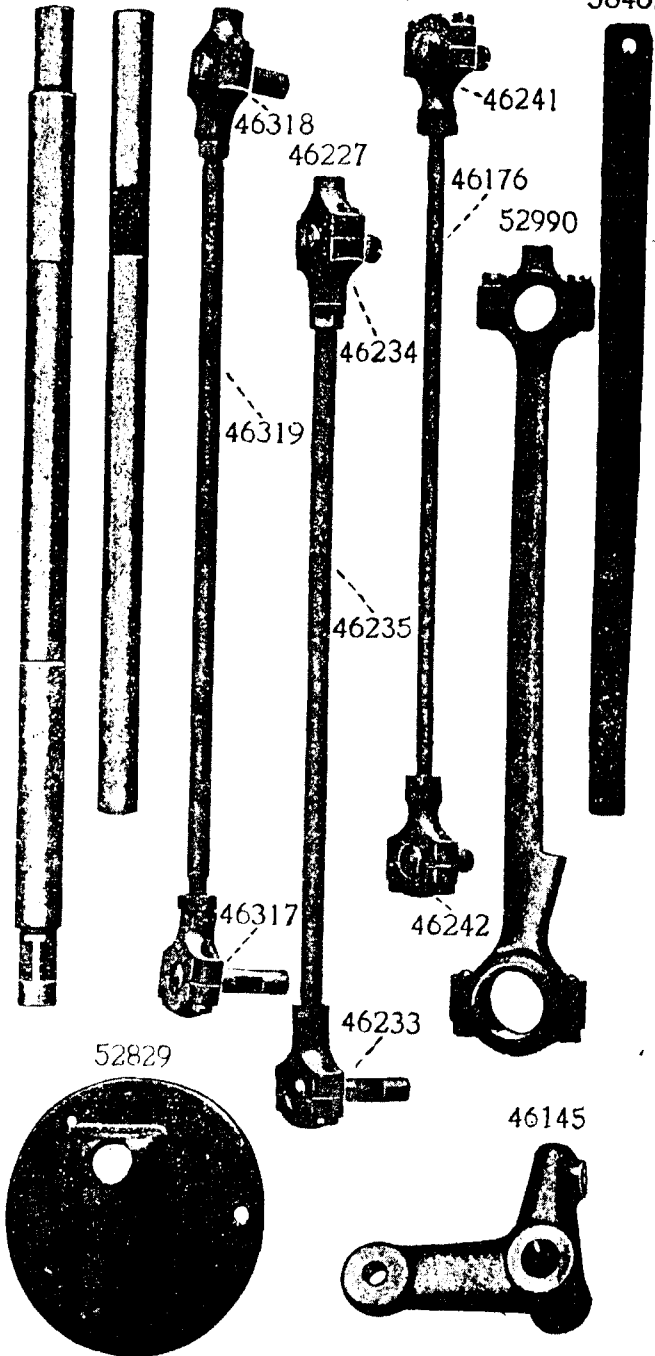


PLATE 6588—FULL SIZE

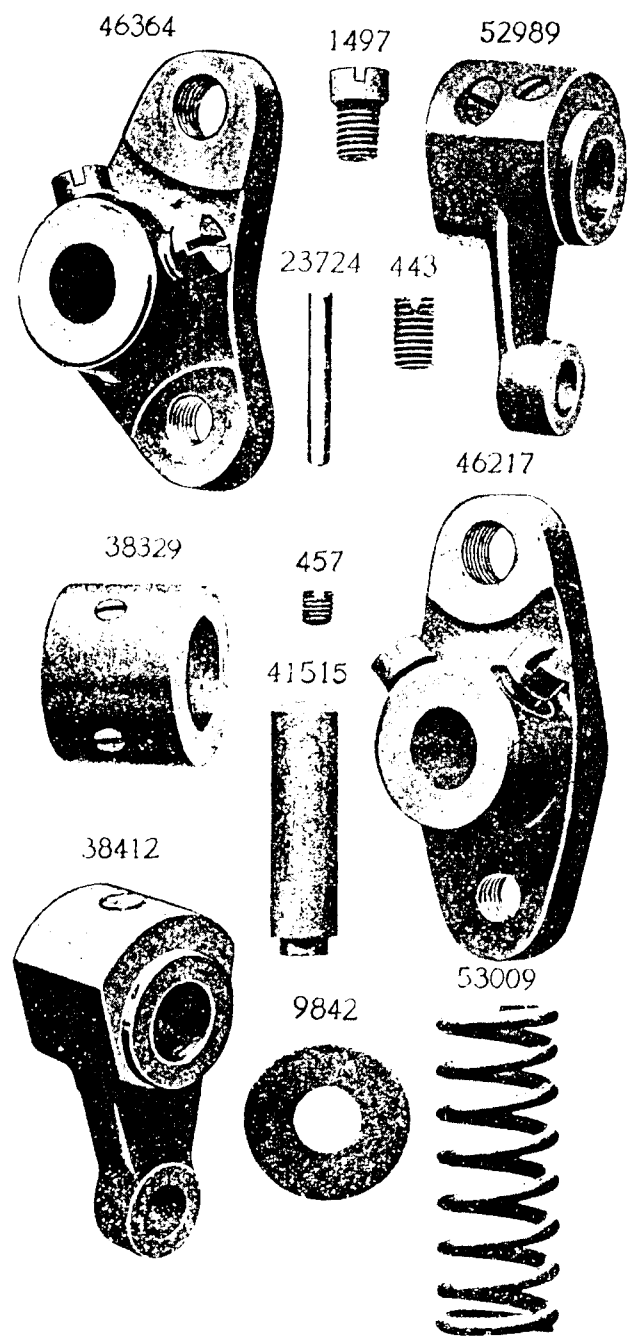
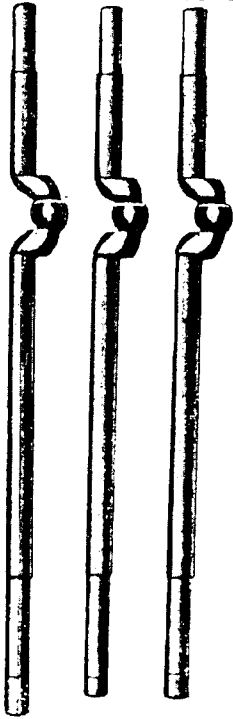
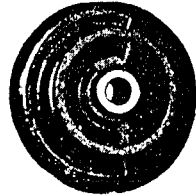


PLATE 6589—ONE-FOURTH SIZE

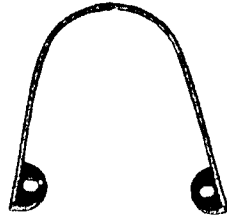
46365 52945 46343



23873



53119



52999

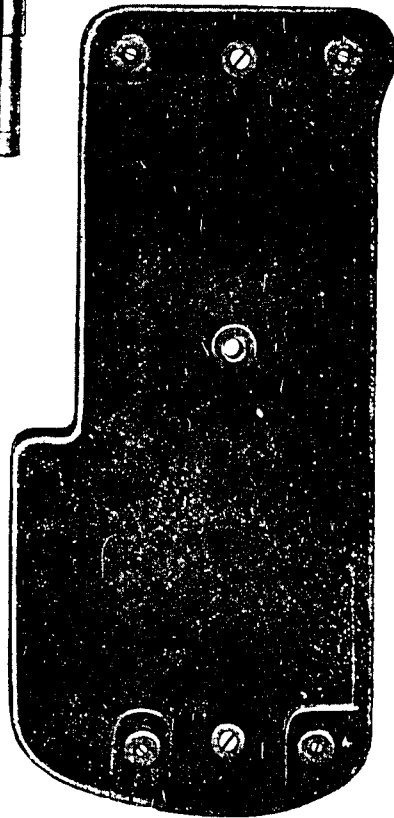
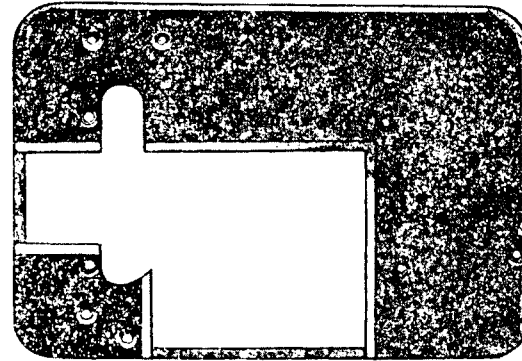


PLATE 6590—ONE-FOURTH SIZE

52830



52946

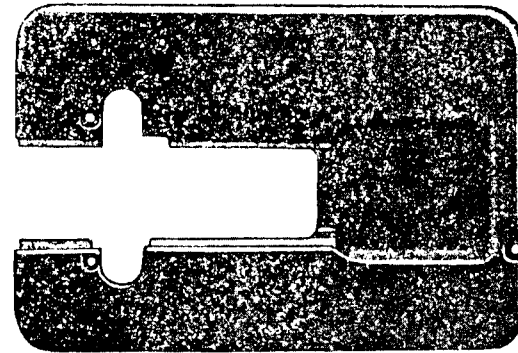
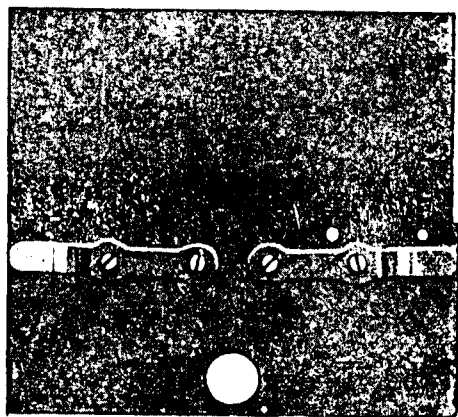
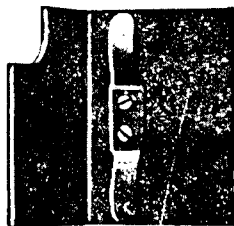


PLATE 6591—ONE-HALF SIZE

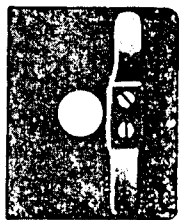
52893



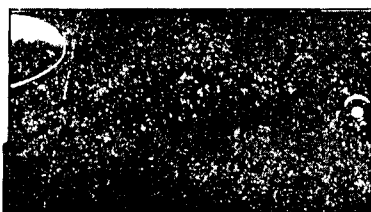
52948



52834



52631



46463

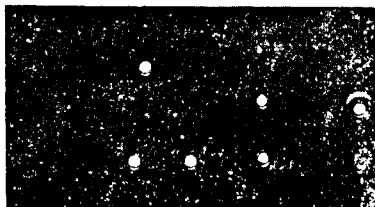
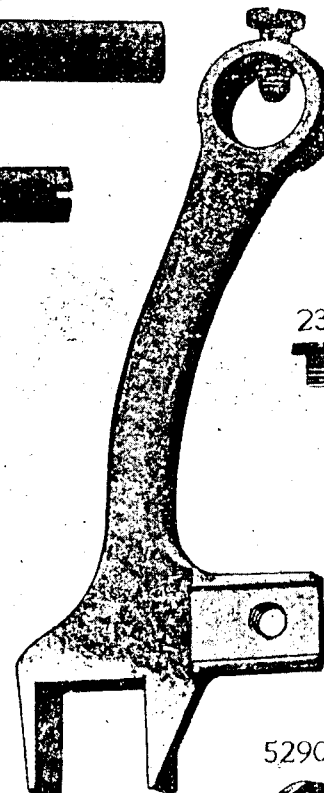


PLATE 6592—FULL SIZE

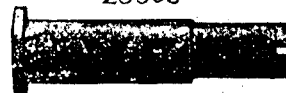
23726



52959



23866



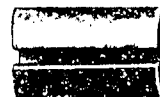
46439



231



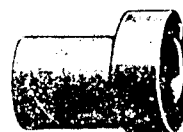
23716



38426



38429



465



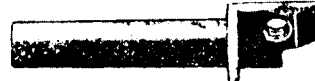
52900



211



52899



52901

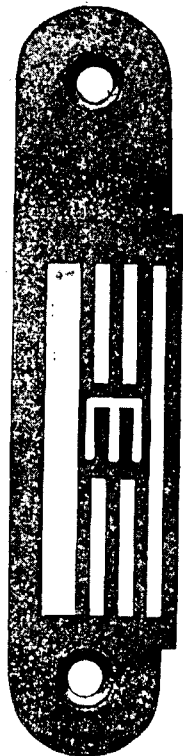


999

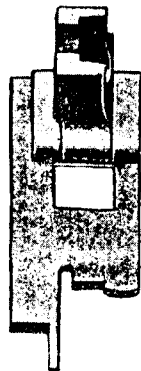


PLATE 6593—FULL SIZE

53173



53170



53168



52898

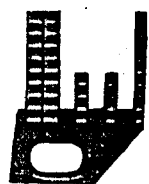
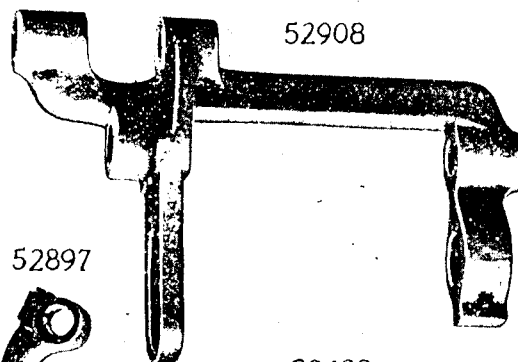


PLATE 6594—ONE-HALF SIZE

52908



52897



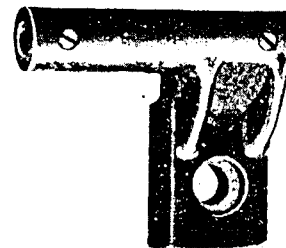
38433



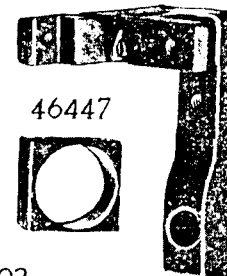
52896



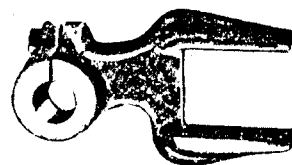
38432



46040



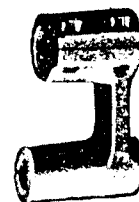
52904



46447



52905



52902



PLATE 6595—FULL SIZE

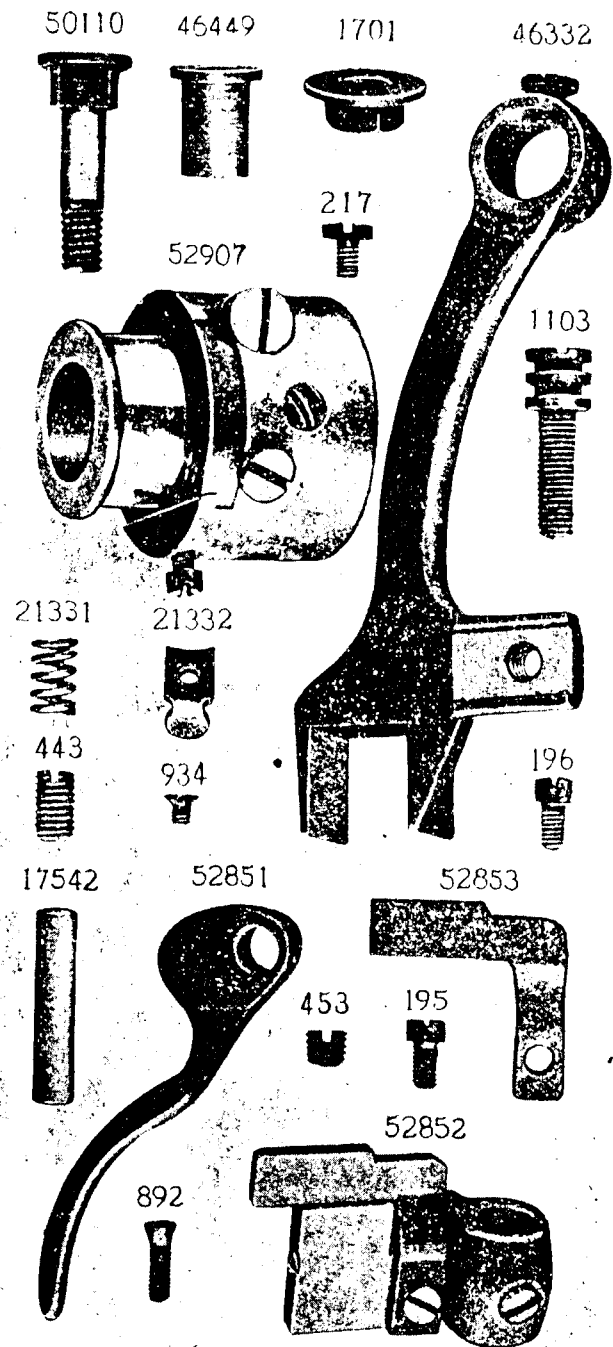


PLATE 6596—FULL SIZE

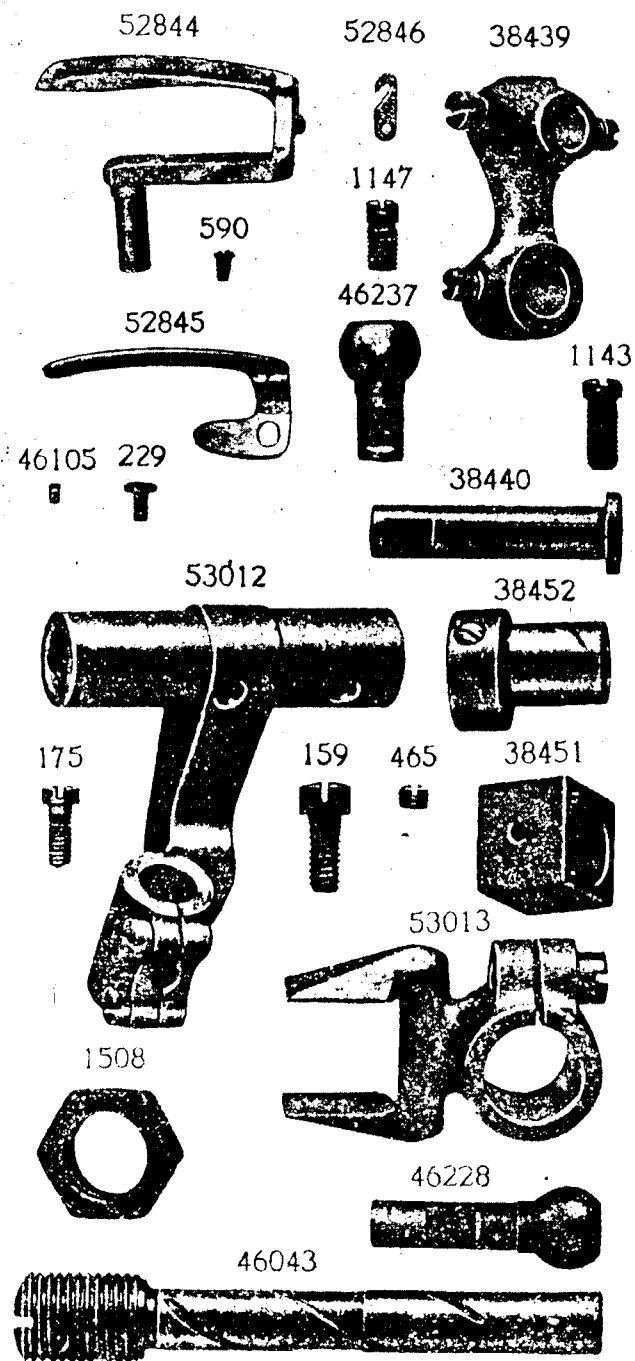


PLATE 6597—FULL SIZE

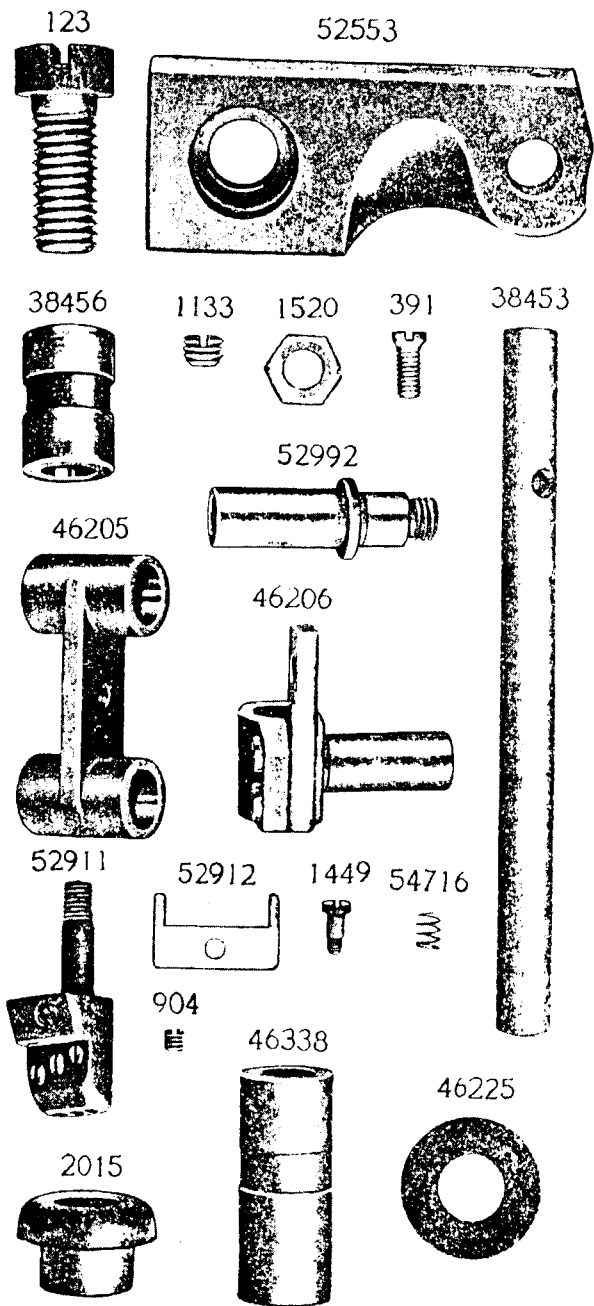


PLATE 6598—ONE-HALF SIZE

46051 52850 38008 46092 38455 17540

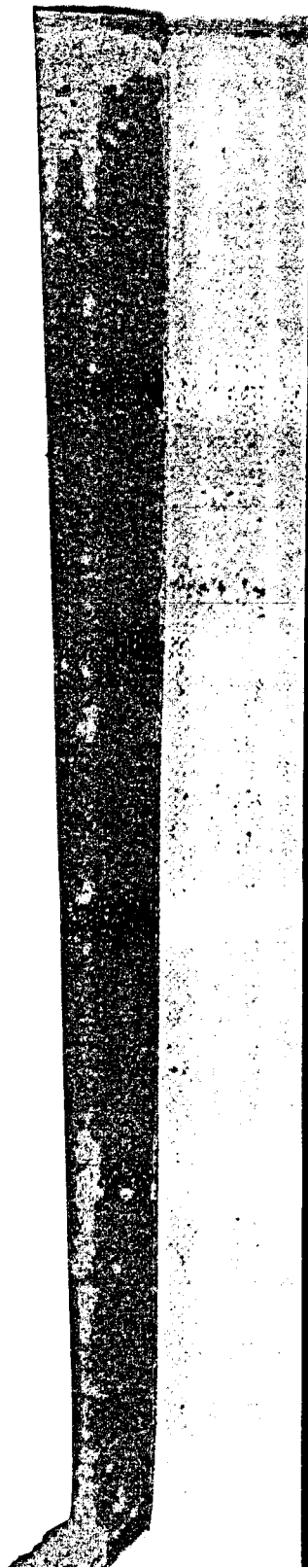
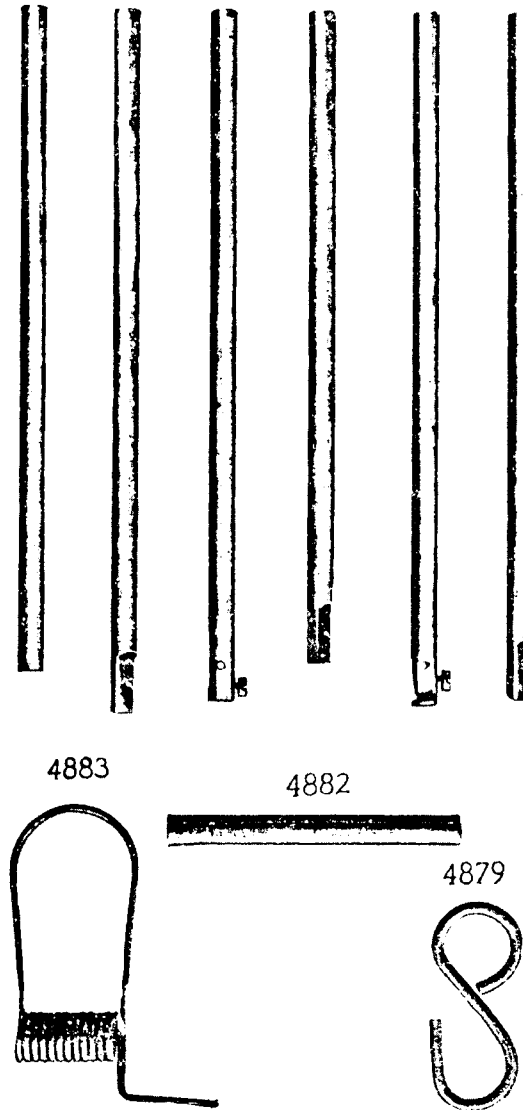


PLATE 6599—FULL SIZE

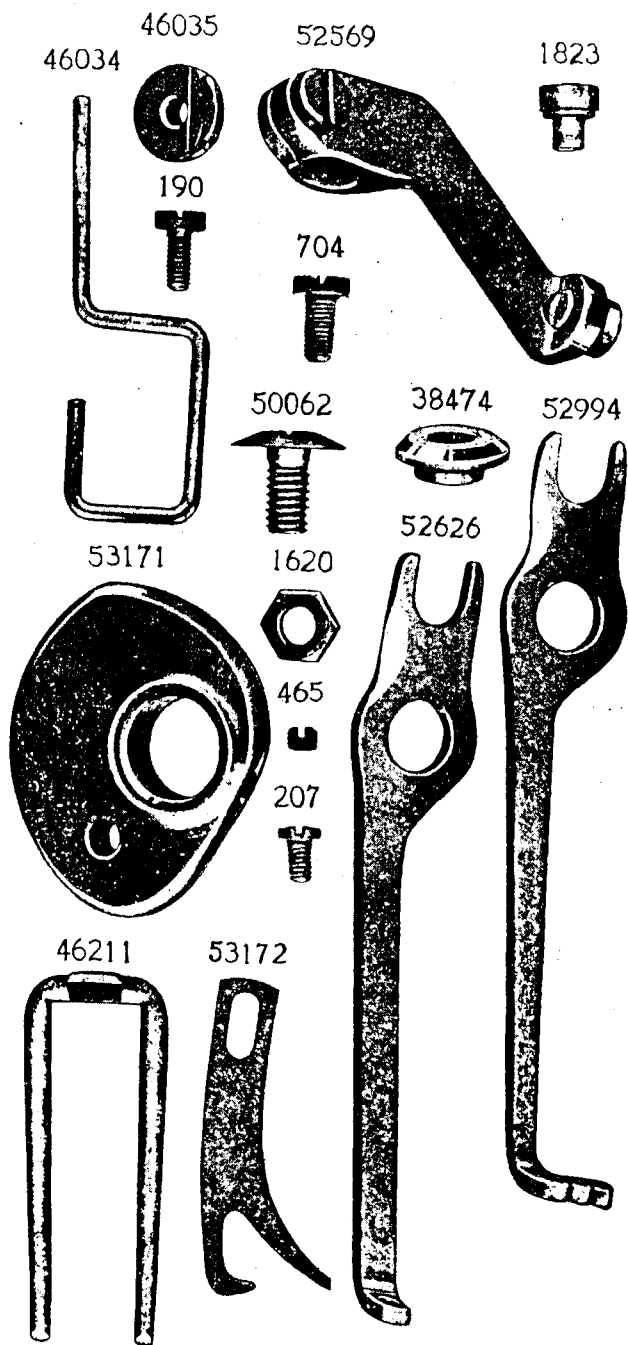


PLATE 6600—FULL SIZE

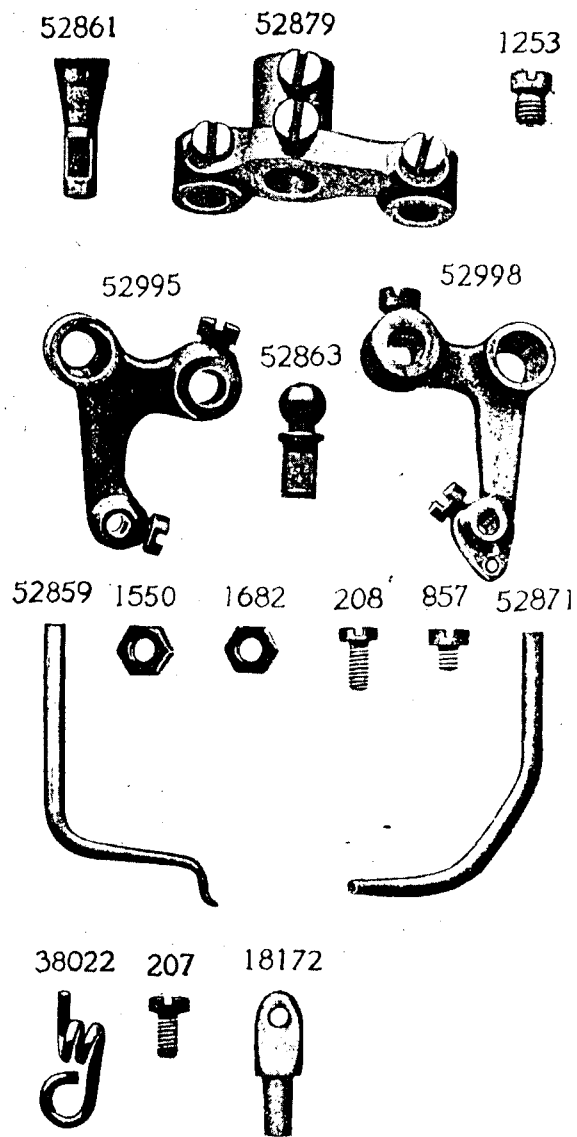


PLATE 6601—FULL SIZE

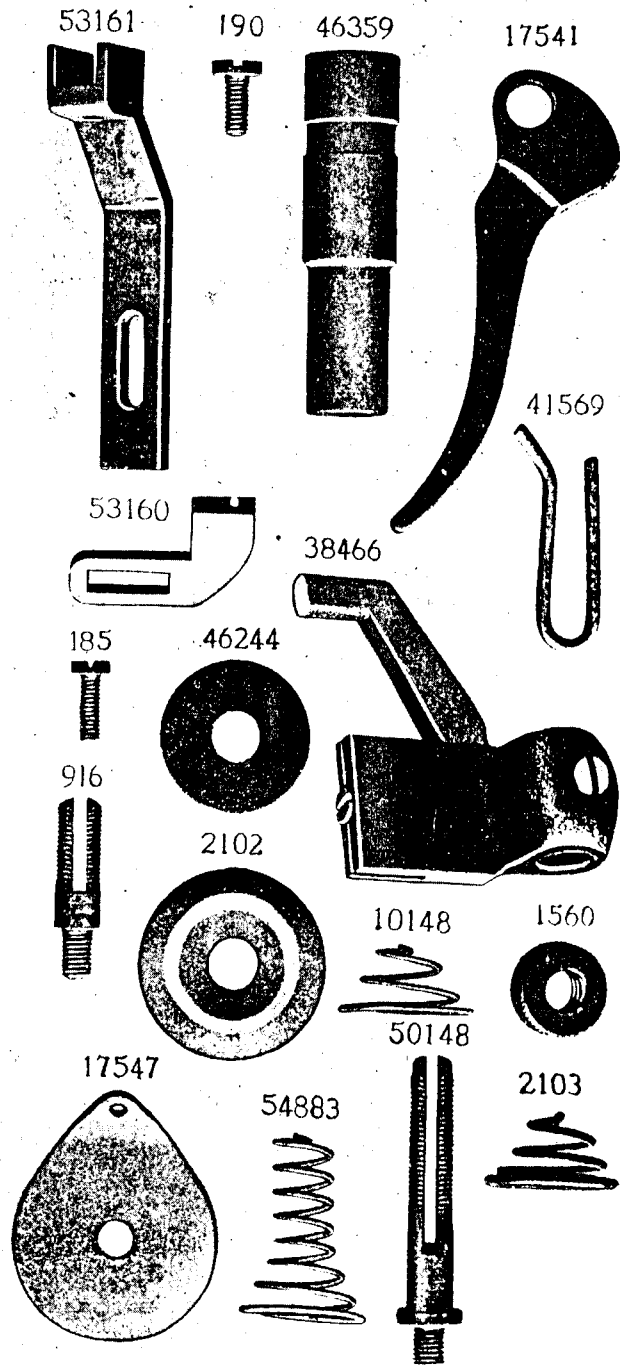


PLATE 6602—FULL SIZE

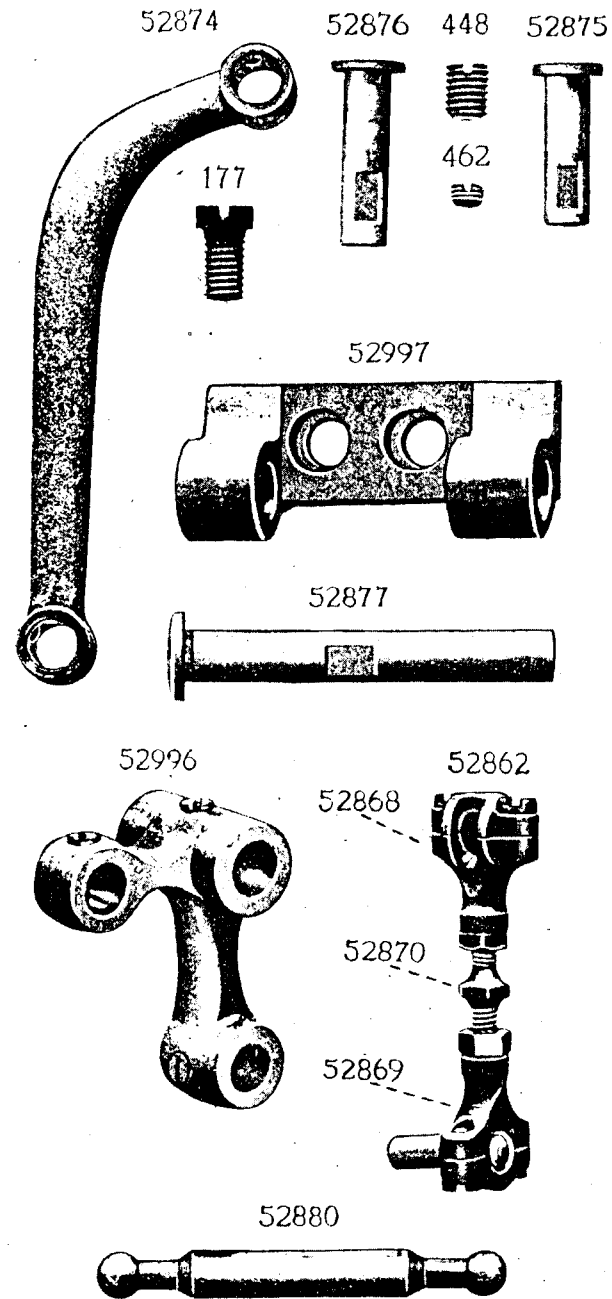


PLATE 6603—FULL SIZE

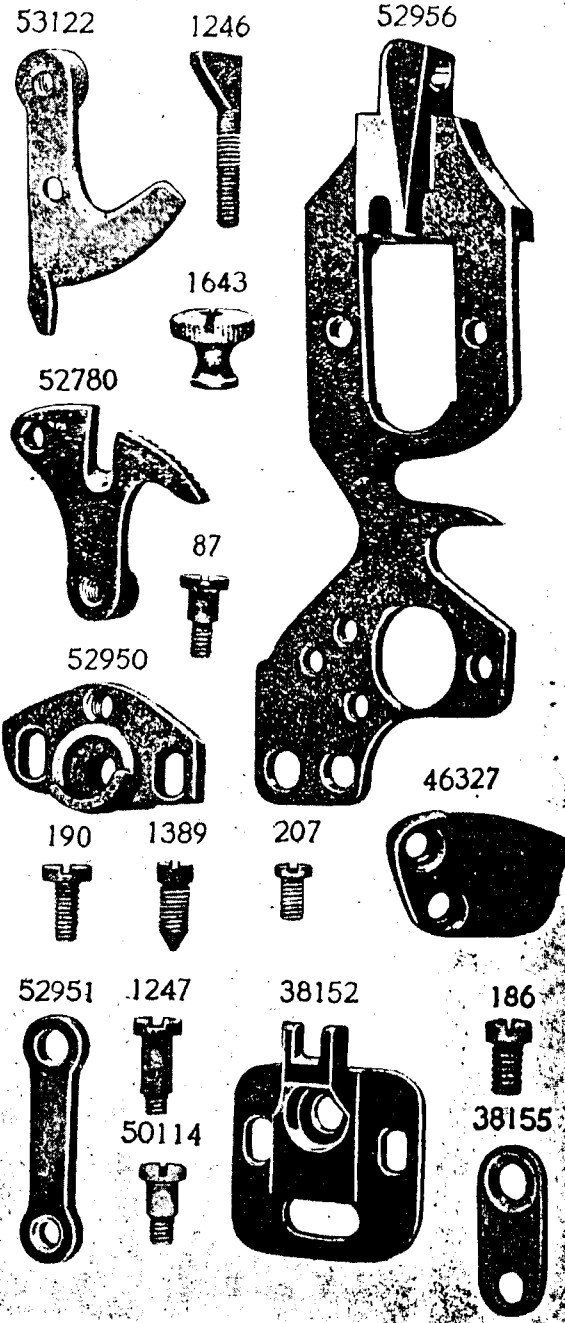


PLATE 6604—FULL SIZE

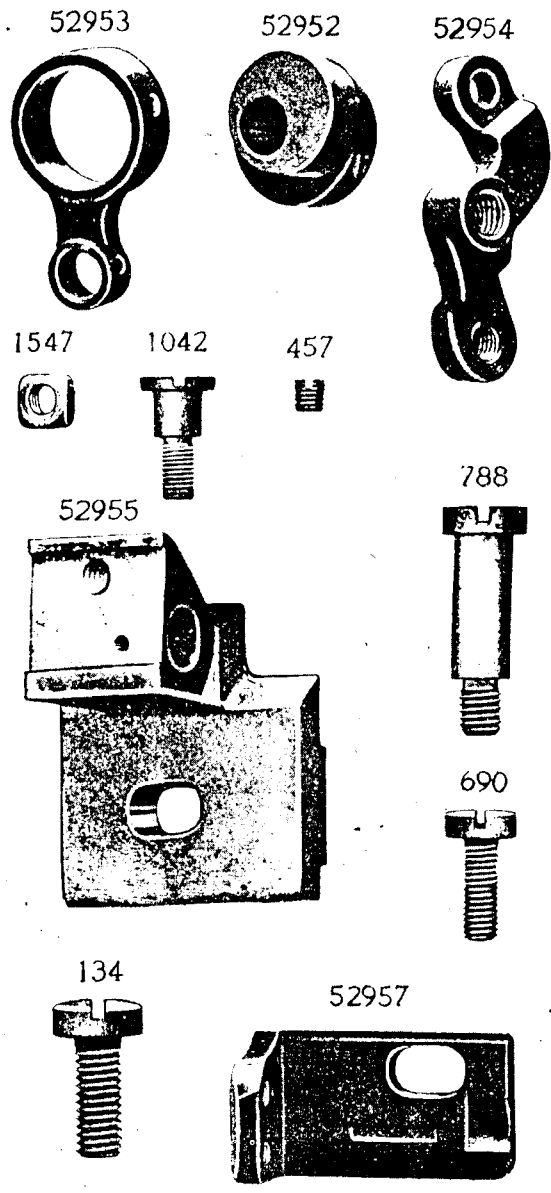
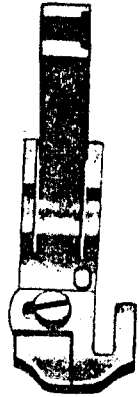


PLATE 6605—FULL SIZE

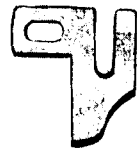
52967



53044



53042



52960



240

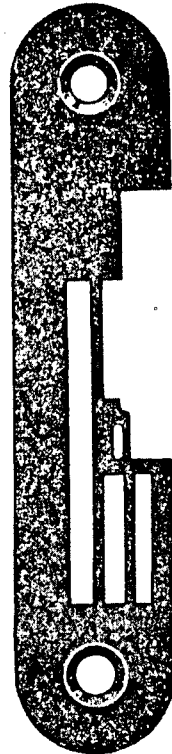


52961



PLATE 6606—FULL SIZE

52972



46362



52970



52971

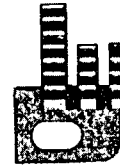


PLATE 6607—FULL SIZE

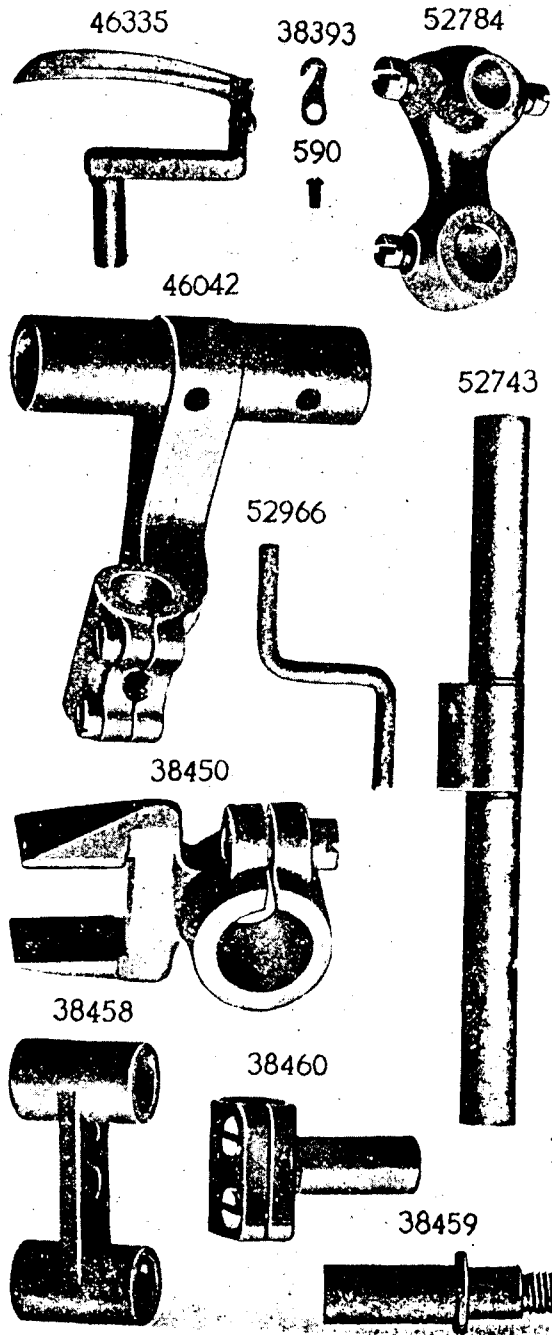


PLATE 6608—FULL SIZE

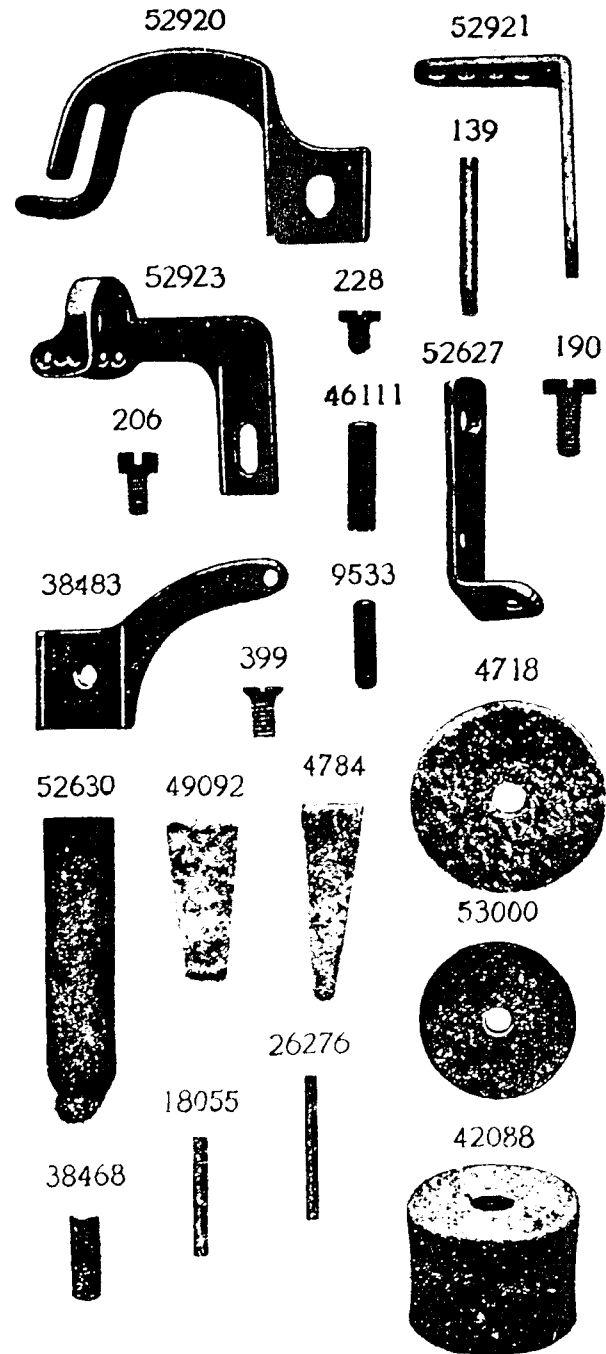


PLATE 6609--FULL SIZE

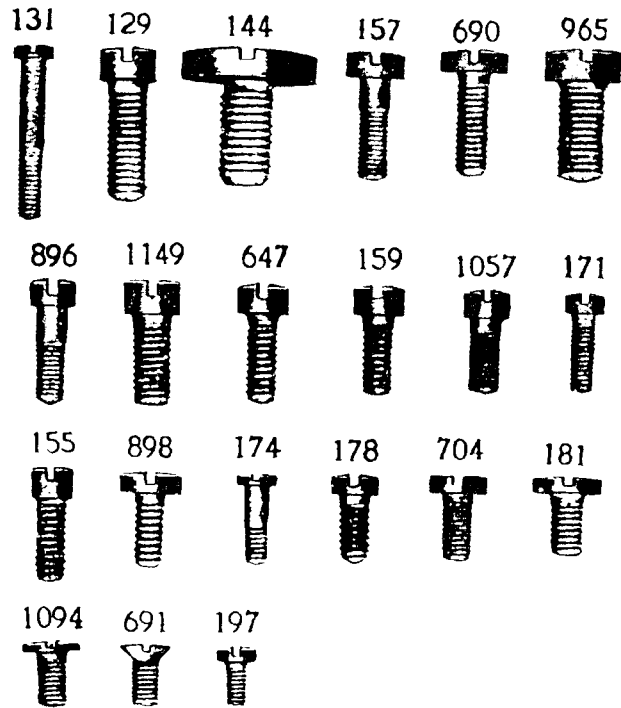


PLATE 6610--FULL SIZE

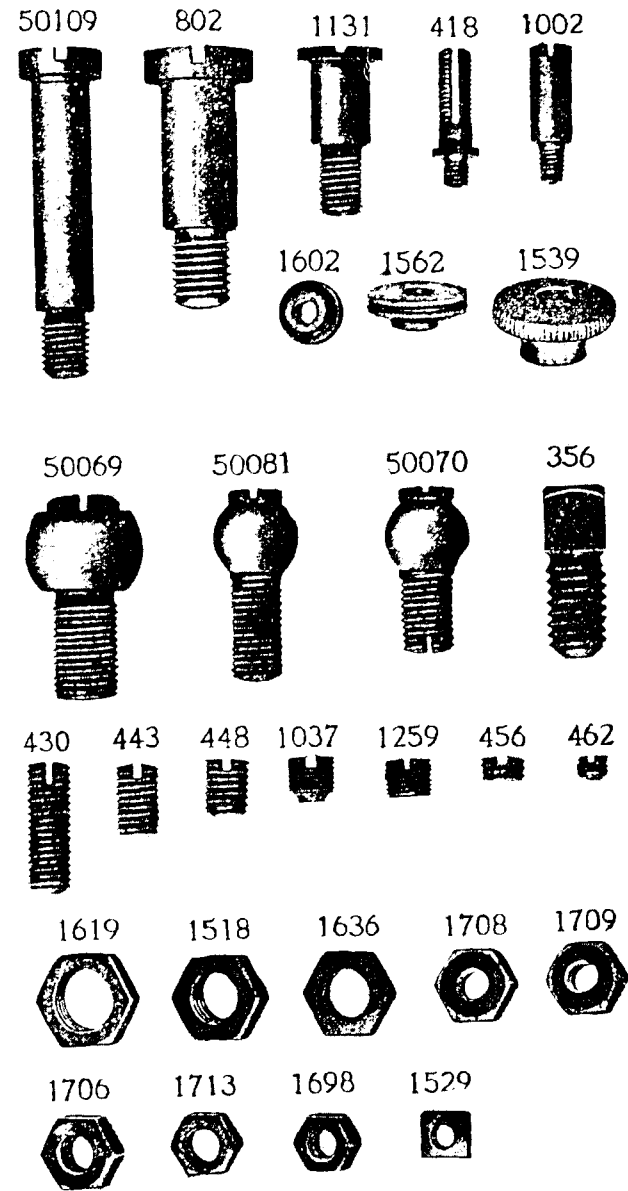


PLATE 6611—FULL SIZE

1408

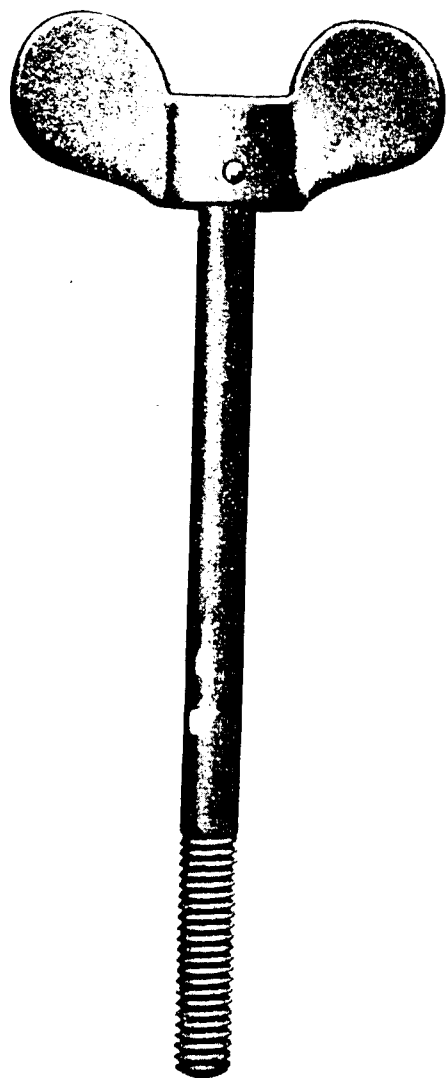


PLATE 6612—ONE-HALF SIZE

26026 26485 36563 22003 38487

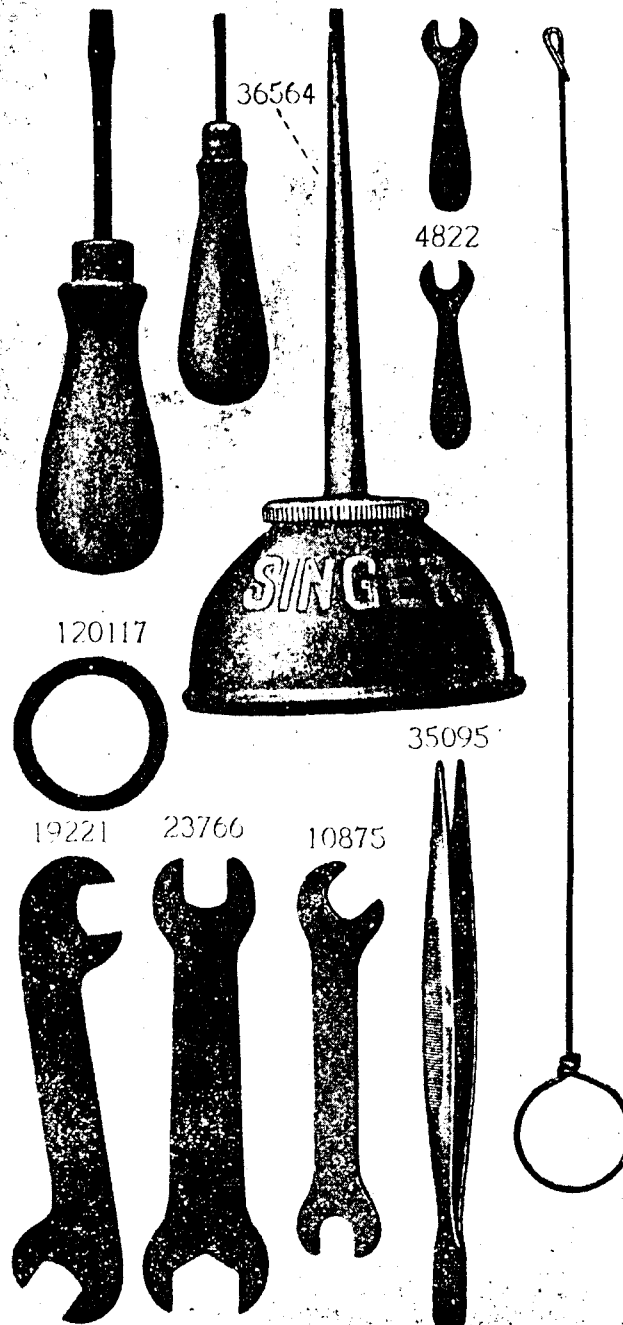
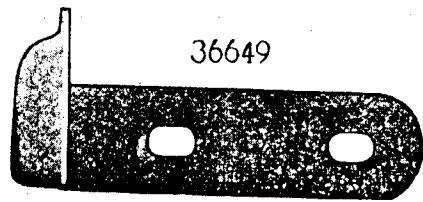


PLATE 6613—FULL SIZE



1443

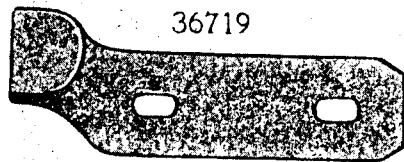
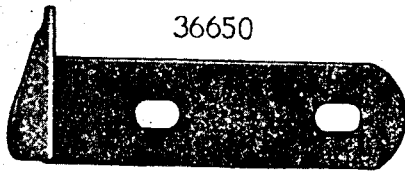


PLATE 6614—ONE-FOURTH SIZE

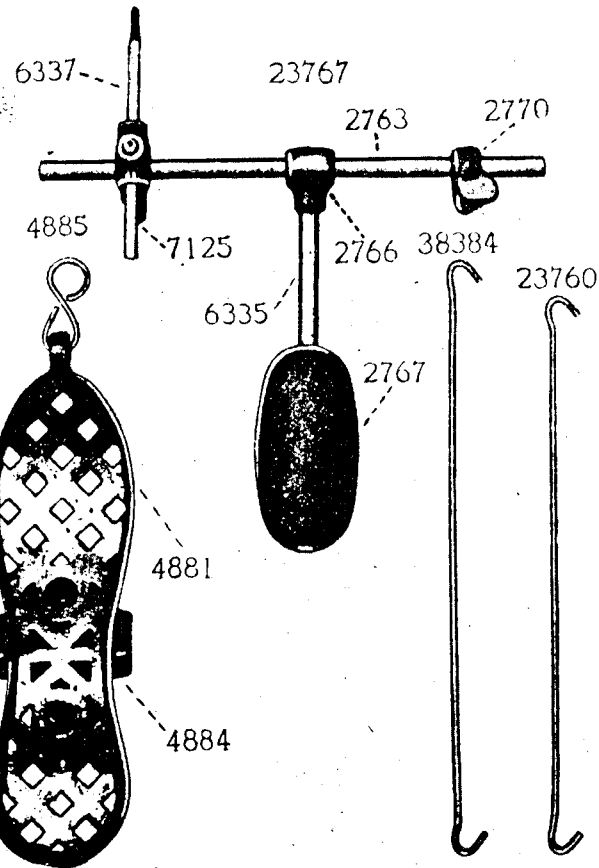
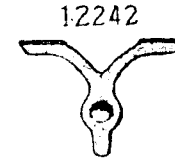
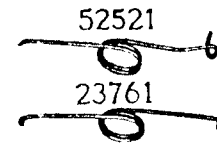
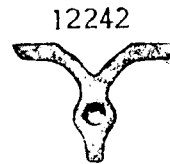
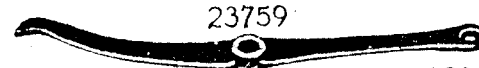
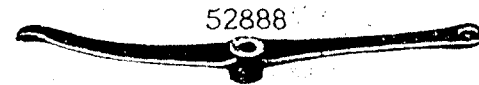
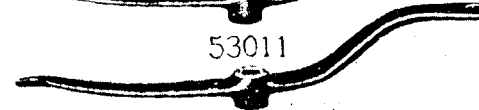
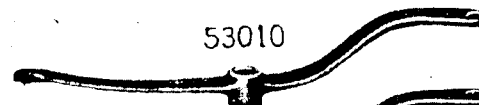


PLATE 6615—ONE-HALF SIZE

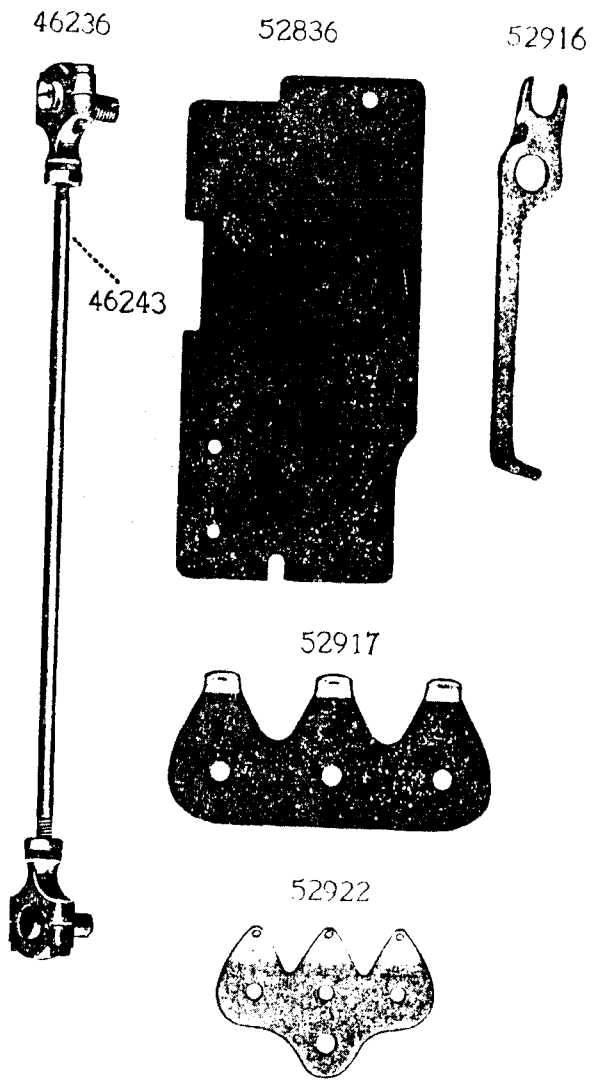


PLATE 6616—FULL SIZE

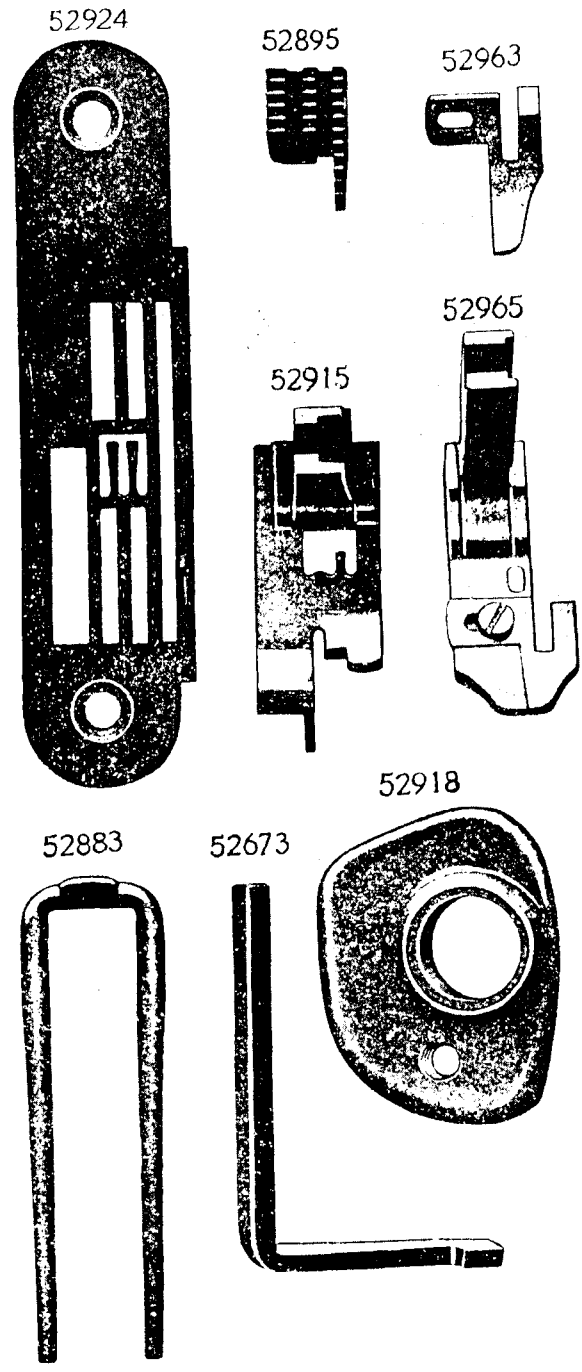
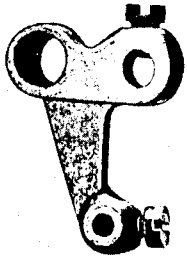
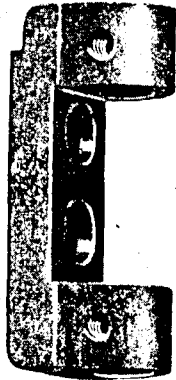


PLATE 6617—FULL SIZE

52860



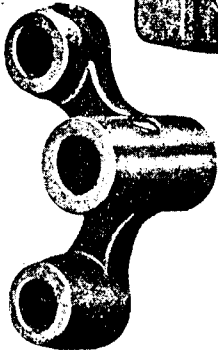
52873



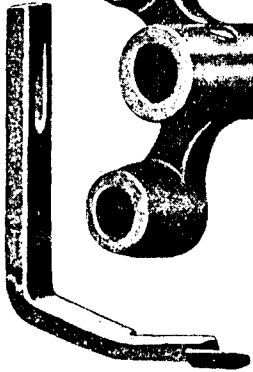
52878



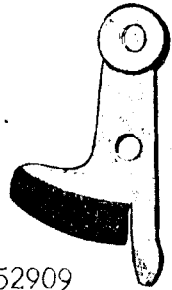
52872



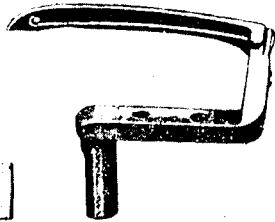
52962



52781



52909



52919



10141



52910



2455



52828

