

Singer 7-27

Singer 7-28

Singer 7-38

Singer 7-39

Form 18235  
January, 1928  
PRINTED IN U. S. A.

**LIST**  
**OF**  
**PARTS**



**MACHINES**  
**Nos. 7-27, 7-28, 7-38**  
**and 7-39**

---

**THE SINGER MANUFACTURING COMPANY**

COPYRIGHT, U. S. A.,  
1916, 1918, 1920, 1927 AND 1928  
BY THE SINGER MANUFACTURING COMPANY  
ALL RIGHTS RESERVED FOR ALL COUNTRIES

## INDEX

	PAGE
ACCESSORIES.....	29
BELT SHIFTER PARTS.....	25
BOBBIN WINDERS.....	31
DRIVING ATTACHMENTS.....	27
CORDER (ADJUSTABLE).....	29
FOOT LIFTER PARTS.....	35
HEMMER ON SLIDE.....	30
LAP SEAM FELLERS.....	30
MACHINE No. 7-27.....	7
"    "    7-28.....	17
"    "    7-38.....	24
"    "    7-39.....	25
NUMERICAL LIST OF PARTS.....	39
STAND No. 25206.....	36
"    "    25207.....	37
TABLE BELT GUIDE.....	38
THREAD UNWINDER.....	38

## INSTRUCTIONS FOR ORDERING

In ordering from this list, use **ONLY** the part NUMBER in the **FIRST** column.

The number stamped on a Sewing Machine part is in every case the number of the single part only.

Every combination of parts sent out as such has its specific number, which, although not stamped on the parts, must be used when ordering the combination.

Each number always indicates the **SAME PART** in whatever list it appears or for whatever machine.

The letters after some of the numbers indicate the style of finish only, as follows:

- A. Hardened, Polished and Plated.
- B. Polished and Plated.
- C. Hardened only.
- D. Polished only.
- E. Soft, not Polished.
- F. Hardened and Polished.
- G.
- H. Blued.
- J. Plated only.
- K. Hardened and Plated.
- L. Brass or Gilt.
- M. Oxidized.
- P. Japanned.
- R. Merlized.
- T. Copper-plated.

These letters **MUST BE USED** when they appear in the list, and **AFTER** the number as in the list.

In this series:

- 1 to 1500 and 50001 to 51500 are Screw Numbers.
- 1501 to 1800 and 51501 to 51800 are Nut Numbers.
- 1801 to 2000 and 51801 to 52000 are Roller Numbers.
- 2001 to 50000 and 52001 and upward are numbers of Machine Parts.

The figures in the second column refer only to the plates, illustrating the parts, and are **NOT TO BE USED** in ordering.

Parts marked with an asterisk (\*) are furnished only when repairs are made at factory.

When ordering parts which differ as to **GAUGE** (the distance between seams) the **GAUGE** as well as the **NUMBER MUST BE GIVEN** on order.

## LIST OF PARTS COMPLETE FOR

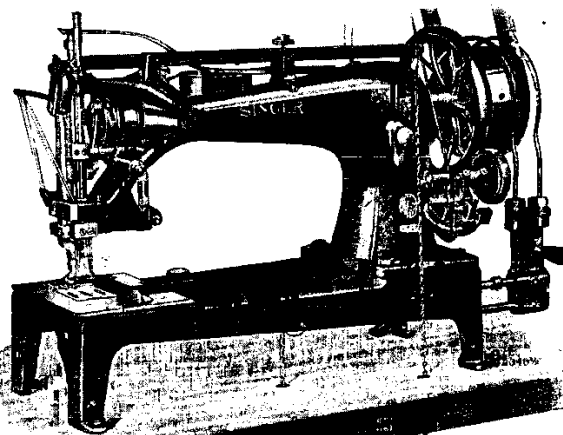

## MACHINE No. 7-27

**HAS TWO NEEDLES, TWO CYLINDER SHUTTLES, Nos. 19568 AND 19569. GAUGES 3/4 TO 1 INCH. CAN BE FURNISHED FROM 1 INCH UP TO 1 1/2 INCH GAUGE AT AN ADDITION OF \$55.00 TO THE REGULAR SELLING PRICE OF THE MACHINE. INDEPENDENT UPPER AND UNDER FEEDS, EACH OF WHICH CAN BE REGULATED AS DESIRED. FOOT LIFTER AND BELT SHIFTER.**

NO.	PLATE	NAME
*19964	—	Arm.....
8702	7854	" Dowel Pin.....
50348E	7855	" Screw.....
11878	7856	" Shaft.....
11354	7857	" " Bushing.....
437C	899	" " " Set Screw.....
19668	911	" Side Cover.....
65D	899	" " " Hinge Screw.....
19786	7858	" Spool Bracket.....
19787	4403	" " " Spool Pin.....

NO.	PLATE	NAME
19788	—	Arm Spool Bracket complete, Nos. 19786 and two 19787
338D	7855	Arm Spool Bracket Screw
58411	7849	Balance Wheel (grooved) 4 $\frac{1}{8}$ in. diam., with two 354c
58407	7849	Balance Wheel and Pulley (tight) with two 354c
354c	899	Balance Wheel and Pulley (tight) Set Screw
354c	899	Balance Wheel Set Screw
*19556	—	Bed
58218	7858	Cloth Plate with 58219, 58220 and four 58221
*58219	—	Cloth Plate Packing (back)
*58220	—	" " " (front)
58221	4492	" " " Rivet
389P	901	" " " Screw
11363	7856	Crank Connecting Rod with 11364 and two 145E
*11364	—	Crank Connecting Rod Cap
145E	899	" " " " Screw
565c	898	" " " " Hinge Screw
1513j	7859	" " " " " Nut
58327	7860	Feed (lower) Bar
307c	898	" " " " Screw Centre
1513j	7859	" " " " " Nut
11367	7857	" " " " Cam with two 445c
445c	7859	" " " " Set Screw
11368	7857	" " " " Connecting Link
565c	898	" " " " " Hinge Screw
1513j	7859	" " " " " " " Nut
58328	4498	Feed (lower) Dog
381D	899	" " " " " Screw
11370	7856	" " " " " Forked Connection
565c	898	" " " " " " " Hinge Screw
1513j	7859	" " " " " " " " Nut
19970	7847	Feed (lower) Lifting Rock Shaft with 134D, 2022 and 19967
19971	—	Feed (lower) Lifting Rock Shaft complete, Nos. 19812 and 19970
19812	4421	Feed (lower) Lifting Rock Shaft Crank with 346E and 1861
346E	7859	Feed (lower) Lifting Rock Shaft Crank Clamping Screw

NO.	PLATE	NAME
1861	7854	Feed (lower) Lifting Rock Shaft Crank Roller and Stud
564c	898	Feed (lower) Lifting Rock Shaft Screw Centre
1508E	7850	Feed (lower) Lifting Rock Shaft Screw Centre Nut
19967	7857	Feed (lower) Lifting Rock Shaft Wearing Block
2022	7854	Feed (lower) Lifting Rock Shaft Wearing Block Position Pin
134D	7859	Feed (lower) Lifting Rock Shaft Wearing Block Screw
11375	7857	Feed (lower) Regulator
568E	898	" " " " Hinge Screw
50322D	7855	" " " " Thumb Screw
58233	7847	" " " " Rock Shaft
58234	—	Feed (lower) Rock Shaft complete, Nos. 58233 and 58235
58235	4491	Feed (lower) Rock Shaft Crank with 346E
346E	7859	" " " " " Clamping Screw
564c	898	Feed (lower) Rock Shaft Screw Centre
1508E	7850	" " " " " " " Nut
19669	911	" (upper) Bar
19670	912	" " " " Guide Bracket (lower) with 456c
19671	—	Feed (upper) Bar Guide Bracket (lower) complete, Nos. 19670, 19672 and two 190D
19672	912	Feed (upper) Bar Guide Bracket (lower) Cap
190D	899	Feed (upper) Bar Guide Bracket (lower) Cap Screw
2117	7854	Feed (upper) Bar Guide Bracket (lower) Pin
456c	7859	Feed (upper) Bar Guide Bracket (lower) Set Screw
19673	911	Feed (upper) Bar Guide Bracket (upper)
159D	901	" " " " " " " Screw (back)
134D	7859	Feed (upper) Bar Guide Bracket (upper) Screw (front)
19674	911	Feed (upper) Bar Hinge Bracket with 145D, 795c and two 445c
145D	899	Feed (upper) Bar Hinge Bracket Adjusting Screw

NO.	PLATE	NAME
19675	911	Feed (upper) Bar Hinge Bracket Guide Plate.....
381D	899	Feed (upper) Bar Hinge Bracket Guide Plate Screw.....
795c	7861	Feed (upper) Bar Hinge Bracket Set Screw (long).....
445c	7859	Feed (upper) Bar Hinge Bracket Set Screw (short).....
448c	7859	Feed (upper) Bar Hinge Bracket Support Screw.....
1520E	7859	Feed (upper) Bar Hinge Bracket Support Screw Nut.....
23D	7859	Feed (upper) Bar Hinge Screw.....
19676	7857	" " Cam with two 445c.....
445c	7859	" " Set Screw.....
19527	7860	" " Connecting Link.....
65D	899	" " " " Hinge Screw.....
19528	7857	" " Regulator with 231c and 453c.....
912c	7861	Feed (upper) Regulator Adjusting Screw.....
1596D	7859	" " " " " " Nut.....
19529	7862	Feed (upper) Regulator Adjusting Screw Sleeve.....
231c	901	Feed (upper) Regulator Adjusting Screw Stop Screw.....
3012	7854	Feed (upper) Regulator Pin.....
453c	899	" " " Set Screw.....
19677	7857	" " " Shaft.....
11393	7848	" " " " Collar with two 453c.....
453c	899	Feed (upper) Regulator Shaft Collar Set Screw.....
11708	7857	Feed (upper) Regulator Shaft Driving Crank with 453c and 1804.....
3012	7854	Feed (upper) Regulator Shaft Driving Crank Pin.....
1804	899	Feed (upper) Regulator Shaft Driving Crank Roller and Stud.....
453c	899	Feed (upper) Regulator Shaft Driving Crank Set Screw.....
11698	7857	Feed (upper) Shaft.....
19678	912	" " " Crank with 453c, 1518E and 1845.....
2117	7854	Feed (upper) Shaft Crank Pin.....
1845	899	" " " " Roller and Screw Stud.....

NO.	PLATE	NAME
1518E	7859	Feed (upper) Shaft Crank Roller and Screw Stud Nut.....
453c	899	Feed (upper) Shaft Crank Set Screw.....
19532	869	" " " Driving Crank with 453c.....
2117	7854	Feed (upper) Shaft Driving Crank Pin.....
453c	899	" " " " " Set Screw.....
19679	912	Feeding Foot.....
164D	899	" " Screw.....
1654c	7859	" " " Nut.....
26419	7863	Guide (6 in. face).....
885D	7855	" Thumb Screw.....
19535	7864	Lifting Presser Bar.....
19536	—	" " " 19535 with 64052.....
19680	7865	" " " Bell Crank.....
19681	—	Lifting Presser Bar Bell Crank complete, Nos. 611c, 19540 and 19680.....
19539	7865	Lifting Presser Bar Bell Crank Adjusting Link.....
19540	—	Lifting Presser Bar Bell Crank Adjusting Link complete, Nos. 1518E, 1828, 2718 and 19539.....
1828	899	Lifting Presser Bar Bell Crank Adjusting Link Roller with 372c.....
372c	898	Lifting Presser Bar Bell Crank Adjusting Link Roller Screw.....
1518E	7859	Lifting Presser Bar Bell Crank Adjusting Link Roller Screw Nut.....
2718	897	Lifting Presser Bar Bell Crank Adjusting Link Roller Screw Nut Washer.....
611c	7855	Lifting Presser Bar Bell Crank Adjusting Link Screw.....
19682	913	Lifting Presser Bar Bell Crank Connecting Stud with 445c and 523c.....
523c	901	Lifting Presser Bar Bell Crank Connecting Stud Set Screw (large).....
445c	7859	Lifting Presser Bar Bell Crank Connecting Stud Set Screw (small).....
50206D	7855	Lifting Presser Bar Bell Crank Hinge Screw.....
1583E	7859	Lifting Presser Bar Bell Crank Hinge Screw Nut.....
11909	7860	Lifting Presser Bar Lifter with 8761 and 8763.....
8760	7850	Lifting Presser Bar Lifter Friction Washer.....
16D	899	" " " " Hinge Screw.....
8761	7854	" " " " Stop Pin.....

NO.	PLATE	NAME
19683	913	Lifting Presser Bar Lifting Link .....
8763	7854	" " " " " Hinge Stud
8973	7854	" " " " " " "
		Pin .....
43267	4492	Lifting Presser Bar Lifting Link Hinge Stud Washer .....
257E	7855	Lifting Presser Bar Screw Bushing (lower)
913E	7855	" " " " " (upper)
11031	7858	" " " Spring (flat) .....
58252	7851	" " " Bracket .....
1177D	4494	" " " Screw
4389	7854	" " " Guide Pin .....
50323D	7855	" " " Regulating Thumb Screw .....
19732	911	Needle Bar .....
19735	—	Needle Bar complete, with adjustable clamps, Nos. 19732 to 19734 and two 898D .....
*19564	869	Needle Bar Connecting Link .....
566C	898	" " " " Hinge Screw
1513J	7859	" " " " " " "
		Nut .....
19565	869	Needle Bar Connecting Stud with 129D and 445F .....
58203	—	Needle Bar Connecting Stud 19565 with 19564 .....
129D	901	Needle Bar Connecting Stud Clamping Screw .....
445F	7859	Needle Bar Connecting Stud Set Screw .....
257E	7855	" " Screw Bushing .....
19733	914	" Clamp (left) with 191F .....
19734	914	" " (right) with 191F .....
898D	901	" " Screw .....
191F	899	" Set Screw .....
58253	—	Oil Cup .....
11917	7847	" " Cover .....
9084	7854	" " " Hinge Pin .....
2205	7854	" " " Latch Spring .....
207F	901	" " " " " Screw .....
8953	7854	" or Wax Stripper (felt) .....
11918	7854	" " " " Washer (steel) for 11917 .....
8482	7862	Oil or Wax Stripper Washer (steel) for 58253 .....
207F	901	Oil or Wax Stripper Washer Screw .....

NO.	PLATE	NAME
58254	7847	Oil Cup complete, Nos. 2205, 8482, 9084, 11917, 11918, 58253, two 8953 and three 207F .....
	134D	7859 Oil Cup Screw .....
*11841	7848	Oscillating Rock Shaft (steel) .....
11842	—	Oscillating Rock Shaft complete, Nos. 622c, 1508E, 11165, 11841 and 58293 .....
11398	7848	Oscillating Rock Shaft Hinge Pin .....
*58293	—	" " " " " 11398 with 1508E .....
1508E	7850	Oscillating Rock Shaft Hinge Pin Nut .....
622c	899	" " " " " Screw Bearing .....
1508E	7850	Oscillating Rock Shaft Hinge Pin Screw Bearing Nut .....
11165	897	Oscillating Rock Shaft Oil Pad .....
19567	7858	" Shaft .....
11848	—	" " Crank .....
19696	4421	Oscillating Shaft Crank complete, Nos. 453c, 1513J, 5868 and 11848 .....
40025	4492	Oscillating Shaft Crank Pin .....
453c	899	" " " Set Screw .....
9119	4421	" " " Slide Block .....
5868	4421	Oscillating Shaft Crank Slide Block complete, Nos. 190D, 1054c, 5968 and 9119 .....
190D	899	Oscillating Shaft Crank Slide Block Cap Screw .....
5968	7850	Oscillating Shaft Crank Slide Block Cap Screw Washer .....
1054c	4421	Oscillating Shaft Crank Slide Block Screw Stud .....
1513J	7859	Oscillating Shaft Crank Slide Block Screw Stud Nut .....
11910	7866	Shuttle (inside) Bobbin .....
19570	867	" " Cylinder .....
*19984	—	" " " 19570 with 774F and 19580 .....
8961	7866	Shuttle (inside) Cylinder Hinge Pin .....
19695	866	" " " Latch .....
12002	7866	" " " " Pin .....
11854	7866	" " " " Spring .....
590D	901	" " " " " Screw .....
19573	867	" " Frame .....
*19987	—	" " " 19573 with 590D, 11854, 12002 and 19695 .....
774F	4494	Shuttle (inside) Tension Regulating Screw
19580	866	" " " Spring .....

NO.	PLATE	NAME
19568	866	Shuttle (cylinder, inside) 3 in. diam., complete, Nos. 8961, 11910, 19984 and 19987
11910	7866	Shuttle (outside) Bobbin.....
19571	867	" " Cylinder.....
*19985	—	" " " " 19571 with 774F and 19581.....
8961	7866	Shuttle (outside) Cylinder Hinge Pin.....
11853	7866	" " " " Latch.....
12002	7866	" " " " Pin.....
11854	7866	" " " " Spring.....
590D	901	" " " " " " Screw.....
19574	867	Shuttle (outside) Frame.....
*19988	—	" " " " 19574 with 590D, 11853, 11854 and 12002.....
774F	4494	Shuttle (outside) Tension Regulating Screw.....
19581	866	Shuttle (outside) Tension Spring.....
19569	866	Shuttle (cylinder, outside) 3 in. diam., complete, Nos. 8961, 11910, 19985 and 19988.....
19572	864	Shuttle Driver with 445c.....
8873	7862	" " Pin.....
445c	7859	" " Set Screw.....
19575	864	" Race Back (inside).....
19576	864	" " (outside).....
11833	7850	" " " Position Pin.....
19577	864	" " " Spring.....
32D	901	" " " " Screw.....
19578	864	" " Body.....
19579	—	Shuttle Race complete, Nos. 19575, 19576, 19578, two each 32D, 19577 and four 11833.....
58277	4492	Shuttle Race Dowel Pin.....
123D	901	" " Screw.....
11241	7848	Tension Friction Washer (cloth) large....
8879	7862	" " " " small....
19684	913	" " " " (steel).....
1535E	7859	" Regulating Thumb Nut.....
8787	7862	" " " " Washer..
710E	7861	" Screw Stud.....
19685	913	" " " Flange.....
19686	913	" Spring.....
19687	913	" Thread Guard.....
164D	899	" " " Screw.....
41544	7862	" " " " Washer....
58795	7854	" Wheel.....

NO.	PLATE	NAME
19889	—	Tension (wheel) complete, Nos. 710E, 1535E, 8787, 11241, 19684 to 19686 and two each 8879 and 58795.....
19689	914	Thread Eyelet (double) top of arm.....
166D	899	" " Screw.....
2102	3583	" Retaining Disc.....
1560c	3583	" " Regulating Thumb Nut.....
8905	7850	" " " " " " Washer.....
408E	898	Thread Retaining Screw Stud for 11426... ..
686E	7861	" " " " " " 11041... ..
2103	3583	" " Spring.....
11425	7862	" " Thread Eyelet for 11426.....
11950	7862	" " " " " " 11041.....
11426	—	Thread Retainer (long stud) complete, Nos. 408E, 1560c, 2103, 8905 and two 2102.....
11041	—	Thread Retainer (short stud) complete, Nos. 686E, 1560c, 2103, 8905 and two 2102.....
11428	7867	Thread Take-up Cam (steel) with two 434c.....
8873	7862	" " " Pin.....
434c	899	" " " Set Screw.....
58301	7860	" " Lever.....
58302	—	" " " 58301 with 1995... ..
58316	—	" " " 58302 with 50437D.....
50437D	4494	" " " Hinge Screw.....
1995	7868	" " " Roller and Screw Stud with 1518E.....
1518E	7859	Thread Take-up Lever Roller and Screw Stud Nut.....
19690	914	Thread Take-up Spring.....
19614	7854	" " " Hook for 19691... ..
19694	914	" " " " " " 19675... ..
19691	914	" " " Lever with 19614 and 19793.....
19692	914	Thread Take-up Spring Lever Regulator.....
164D	899	" " " " " " Screw.....
41544	7862	Thread Take-up Spring Lever Regulator Screw Washer.....
19793	914	Thread Take-up Spring Lever Stop Pin... ..
19693	914	" " " " Washer....
19591	—	Throat Plate Body.....
19997	—	" " Needle Hole Strip (left)....
19592	868	" " " " (right)....
401D	899	" " " " " " Screw....



NO.	PLATE	NAME
19593	868	Throat Plate complete for 58328, Nos. 19591, 19592, 19997 and four 401D.....
381D	899	Throat Plate Screw.....

**LIST OF PARTS COMPLETE  
FOR  
MACHINE No. 7-28**

**FOR NARROW GAUGES. HAS TWO NEEDLES, TWO BOX SHUTTLES, NOS. 43277 AND 43279. GAUGE AS SPECIFIED ON ORDER, FROM  $\frac{3}{16}$  TO  $\frac{1}{8}$  INCH. DROP FEED, ADJUSTABLE PRESSER, EITHER VIBRATING OR STATIONARY, AND BELT SHIFTER.**

NO.	PLATE	NAME
*19963	—	Arm with 11559, 19888 and two each 128E and 612E.....
19785	914	Arm Dowel Pin.....
*19887	—	" Packing Plate.....
50347E	4494	" Screw.....
43263	4492	" " Washer.....
19747	7856	" Shaft.....
11354	7857	" " Bushing.....
437C	899	" " " Set Screw.....
11913	7856	" Side Cover.....
65D	899	" " " Hinge Screw.....
19786	7858	" Spool Bracket.....
19787	4403	" " " Spool Pin.....
19788	—	Arm Spool Bracket complete, Nos. 19786 and two 19787.....
338D	7855	Arm Spool Bracket Screw.....
19991	4496	Balance Wheel and Pulley (tight) with two 354C.....
354C	899	Balance Wheel Set Screw.....
*19756	—	Bed.....
58224	7858	Cloth Plate with 58225, 58226 and four 58227.....
*58225	—	Cloth Plate Packing (back).....
*58226	—	" " " (front).....
58227	4492	" " " Rivet.....
145F	899	" " Screw.....
19758	4403	Crank Connecting Rod with 19759 and two 575E.....
*19759	—	Crank Connecting Rod Cap.....
575E	7859	" " " " Screw.....
1151C	7861	" " " Hinge Screw.....
1646E	7859	" " " " " Nut.....

NO.	PLATE	NAME
58216	7858	Face Plate.....
58217	—	Face Plate complete, Nos. 910c, 11867, 11874, 11875, 19583, 19590, 19701, 19866, 19886, 41544, 58216 and three 164d.....
19583	869	Face Plate Thread Eyelet.....
19590	7854	“ “ “ Guard.....
164d	899	“ “ “ “ Screw.....
161d	901	“ “ “ “ Screw.....
19891	7860	Feed Bar.....
307c	898	“ “ “ “ Screw Centre.....
1513j	7859	“ “ “ “ Nut.....
11367	7857	“ “ “ “ Cam with two 445c.....
445c	7859	“ “ “ “ Set Screw.....
11368	7857	“ “ “ “ Connecting Link.....
565c	898	“ “ “ “ Hinge Screw.....
1513j	7859	“ “ “ “ “ Nut.....
19795	4431	“ “ “ “ Dog, for general work.....
381d	899	“ “ “ “ Screw.....
19762	4403	“ “ “ “ Forked Connection.....
565c	898	“ “ “ “ Hinge Screw.....
1513j	7859	“ “ “ “ “ Nut.....
58346	7856	Feed Lifting Rock Shaft with 134d, 2022 and 19967.....
58400	—	Feed Lifting Rock Shaft complete, Nos. 19812 and 58346.....
19812	4421	Feed Lifting Rock Shaft Crank with 346E and 1861.....
346E	7859	Feed Lifting Rock Shaft Crank Clamping Screw.....
1861	7854	Feed Lifting Rock Shaft Crank Roller and Stud.....
294c	7861	Feed Lifting Rock Shaft Screw Centre... 1503E 7850 “ “ “ “ “ Nut
1503E	7850	“ “ “ “ “ “ “ “ Nut
19967	7857	“ “ “ “ “ “ “ “ Wearing Block
2022	7854	“ “ “ “ “ “ “ “ “ “
134d	7859	Position Pin.....
11375	7857	Feed Lifting Rock Shaft Wearing Block Screw.....
1568E	898	“ “ “ “ Hinge Screw.....
50322d	7855	“ “ “ “ Thumb Screw.....
58233	7847	“ “ “ “ Rock Shaft.....
58234	—	Feed Rock Shaft complete, Nos. 58233 and 58235.....
58235	4491	Feed Rock Shaft Crank with 346E.....
346E	7859	“ “ “ “ “ “ “ “ Clamping Screw

NO.	PLATE	NAME
294c	7861	Feed Rock Shaft Screw Centre.....
1503E	7850	“ “ “ “ “ “ “ “ Nut.....
26176	7863	Guide (6 in. face).....
885d	7855	“ “ “ “ Thumb Screw.....
58236	7864	Lifting Presser Bar.....
11523	7865	“ “ “ “ Bell Crank.....
11524	7865	“ “ “ “ “ “ “ “ Adjusting Link.....
11525	—	Lifting Presser Bar Bell Crank Adjusting Link complete, Nos. 1518E, 1828, 2718 and 11524.....
1828	899	Lifting Presser Bar Bell Crank Adjusting Link Roller with 372c.....
372c	898	Lifting Presser Bar Bell Crank Adjusting Link Roller Screw.....
1518E	7859	Lifting Presser Bar Bell Crank Adjusting Link Roller Screw Nut.....
2718	897	Lifting Presser Bar Bell Crank Adjusting Link Roller Screw Nut Washer.....
611c	7855	Lifting Presser Bar Bell Crank Adjusting Link Screw.....
11526	7854	Lifting Presser Bar Bell Crank Connecting Stud with two 858c.....
11527	—	Lifting Presser Bar Bell Crank Connecting Stud complete, Nos. 164d, 11526 and 11528.....
164d	899	Lifting Presser Bar Bell Crank Connecting Stud Cap Screw.....
11528	7862	Lifting Presser Bar Bell Crank Connecting Stud Cap Screw Washer.....
858c	7859	Lifting Presser Bar Bell Crank Connecting Stud Set Screw.....
50206d	7855	Lifting Presser Bar Bell Crank Hinge Screw.....
1583E	7859	Lifting Presser Bar Bell Crank Hinge Screw Nut.....
11867	7860	Lifting Presser Bar Lifter.....
58237	4491	“ “ “ “ “ “ “ “ Bracket with 1497F and 58238.....
1497F	4491	Lifting Presser Bar Lifter Bracket Set Screw.....
58238	4491	Lifting Presser Bar Lifter Bracket Spring Bearing.....
19866	7854	Lifting Presser Bar Lifter Hinge Pin.....
910c	7859	“ “ “ “ “ “ “ “ Set Screw.....



NO.	PLATE	NAME
8864	7866	Shuttle (inside) Main Spring.....
838E	7859	" " " " Screw.....
43208	7866	" " " " Steady Pin
791F	4494	" " Tension Regulating Screw
8865	7866	" " " Spring.....
330D	901	" " " " Screw.....
14222	7866	" " " " Steady Pin
43277	7820	Shuttle (inside) complete, Nos. 8816, 8861, 43207 and 43280.....
43207	7866	Shuttle (outside) Bobbin.....
16910	7866	" " " Retaining Spring
8818	7866	" " " " " "
		Rivet.....
*8867	—	Shuttle (outside) Body with 838E, 8819, 16910, 43208 and two 8818.....
*43278	—	Shuttle (outside) Cover.....
*43281	—	" " " 43278 with 330D, 791F, 8817, 8818, 8820 and 14222.....
8816	7866	Shuttle (outside) Cover Hinge Pin.....
8817	7866	" " Delivery Eye Thread Guard.....
8818	7866	Shuttle (outside) Delivery Eye Thread Guard Rivet.....
8819	7866	Shuttle (outside) Main Spring.....
838E	7859	" " " " Screw.....
43208	7866	" " " " Steady Pin
791F	4494	" " Tension Regulating Screw
8820	7866	" " " Spring.....
330D	901	" " " " Screw.....
14222	7866	" " " " Steady Pin
43279	7820	Shuttle (outside) complete, Nos. 8816, 8867, 43207 and 43281.....
19894	7867	Shuttle Driver with 445C.....
8055	7862	" " Pin.....
445C	7859	" " Set Screw.....
19895	—	" Race Body.....
19896	4407	" " Loop Separator.....
335D	7859	" " " Screw.....
19776	4408	" " Ring (inside).....
19777	4408	" " " (outside).....
134D	7859	" " " Screw.....
19897	4407	Shuttle Race complete, Nos. 19776, 19777, 19895, 19896, two 335D and six 134D...
58277	4492	Shuttle Race Dowel Pin.....
123D	901	" " Screw.....
11241	7848	Tension Friction Washer (cloth) large....
8879	7862	" " " " small....

NO.	PLATE	NAME
19684	913	Tension Friction Washer (steel).....
1535E	7859	" Regulating Thumb Nut.....
8787	7862	" " " " Washer
709E	7861	" Screw Stud.....
19685	913	" " " Flange.....
19686	913	" Spring.....
58795	7854	" Wheel.....
19701	—	Tension (wheel) complete, Nos. 709E, 1535E, 8787, 11241, 19684 to 19686 and two each 8879 and 58795.....
19584	869	Thread Eyelet (double) top of arm.....
166D	899	" " Screw.....
19585	869	" Retaining Bracket.....
180D	901	" " " Screw.....
2102	3583	" " Disc.....
1560C	3583	" " Regulating Thumb Nut
8905	7850	" " " " " "
		Washer.....
633E	7861	Thread Retaining Screw Stud.....
6312	7866	" " " " Washer....
2103	3583	" " Spring.....
19586	7866	" " Thread Guide Pin....
19587	—	Thread Retainer complete, Nos. 19585, 19586, two each 633E, 1560C, 2103, 6312, 8905 and four 2102.....
11428	7867	Thread Take-up Cam (steel) with two 434C.....
8873	7862	Thread Take-up Cam Pin.....
434C	899	" " " Set Screw.....
58319	4492	" " " Washer.....
58303	7860	" " Lever.....
58304	—	" " " 58303 with 1995..
58312	—	" " " 58304 with 50437D
50437D	4494	" " " Hinge Screw....
1995	7868	" " " Roller and Screw Stud with 1518E.....
1518E	7859	Thread Take-up Lever Roller and Screw Stud Nut.....
11874	7860	Thread Take-up Spring.....
11875	7857	" " " Regulator.....
164D	899	" " " " Screw
164D	899	" " " " Screw.....
41544	7862	" " " " Washer...
19886	7854	" " " Thread Guard...
19796	—	Throat Plate Body.....
19797	4431	" " Needle Hole Strip.....
691D	7859	" " " " " Screw....

NO.	PLATE	NAME
19798	4431	Throat Plate complete for 19795, Nos. 19796, 19797 and two 691d.....
381d	899	Throat Plate Screw.....
19784	4403	Vibrating Presser Bar.....
19888	7865	“ “ “ Cap Bracket (lower)
11559	7865	“ “ “ “ “ (upper)
612E	901	“ “ “ “ “ Screw (long).....
128E	901	Vibrating Presser Bar Cap Bracket Screw (short).....
58239	4491	Vibrating Presser Bar Guide Bracket with 874d and 1497F.....
1497F	4491	Vibrating Presser Bar Guide Bracket Set Screw.....
681d	7859	Vibrating Presser Bar Hinge Screw.....
11563	7854	“ “ “ Spring Stud with 19877.....
19877	7854	Vibrating Presser Bar Spring Stud Pin... ..
190d	899	“ “ “ “ “ Screw
11564	7854	“ “ “ “ “ Spring
58240	4491	“ “ “ Stop Block.....
682d	7859	“ “ “ “ “ Thumb Screw.....
6312	7866	Vibrating Presser Bar Stop Block Thumb Screw Washer.....
874d	4491	Vibrating Presser Bar Stop Block Stop Screw.....
19595	7868	Vibrating Presser Foot.....
690d	7859	“ “ “ Screw.....
1654c	7859	“ “ “ “ Nut.....

## MACHINE No. 7-38

HAS S. D. A., OTHERWISE SAME AS No. 7-27

NO.	PLATE	NAME
58329	7847	Arm Shaft, in place of 11878.....
949d	4494	“ “ Screw.....
9842	4492	“ “ “ Washer.....
122301	7849	Balance Wheel with two 354c.....
122302	4496	“ “ 122301 with 11442, 122307, two 1402d and four 401E.....
25362	7850	Balance Wheel Ball, size $\frac{1}{8}$ in.....
122303	—	“ “ “ Ring.....
122304	7851	“ “ “ “ 122303 with eighteen 25362.....

NO.	PLATE	NAME
122306	7851	Balance Wheel Ball Washer (left).....
122307	7851	“ “ “ “ (right).....
1402d	4494	“ “ “ “ “ Screw
11442	7852	“ “ Friction Washer (paper)...
401E	899	“ “ “ “ Screw....

## MACHINE No. 7-39

HAS S. D. A., OTHERWISE SAME AS No. 7-28

NO.	PLATE	NAME
58334	7856	Arm Shaft, in place of 19747.....
949d	4494	“ “ Screw.....
9842	4492	“ “ “ Washer.....
58335	4496	Balance Wheel with two 354c.....
58336	—	“ “ 58335 with 11442, 122307, two 1402d and four 401E.....
25362	7850	Balance Wheel Ball, size $\frac{1}{8}$ in.....
122303	—	“ “ “ Ring.....
122304	7851	“ “ “ “ 122303 with eighteen 25362.....
122306	7851	Balance Wheel Ball Washer (left).....
122307	7851	“ “ “ “ (right).....
1402d	4494	“ “ “ “ “ Screw
11442	7852	“ “ Friction Washer (paper)...
401E	899	“ “ “ “ Screw....

## BELT SHIFTER PARTS

FOR 7-27 MACHINE

NO.	PLATE	NAME
6439	—	Chain, 36 in. to 45 in., with 56864 and 56865.....

NOTE: When ordering 6439, state length required

4879	7860	Chain Connecting Link.....
56864	7860	“ Hook (large).....
56865	7862	“ “ (small).....
11446	7868	“ Eyelet.....
11447	7865	“ Pulley.....
567d	898	“ “ Screw.....
11940	7867	Fork.....
434c	899	“ Set Screw.....

## BELT SHIFTER PARTS

NO.	PLATE	NAME
11941	7867	Frame with 8804 and two 434c.....
8804	—	“ Handle.....
11450	7864	Guide Rod.....
2117	7854	“ “ Pin.....
58408	—	Pulley (loose).....
58409	7865	“ “ Flanged Bushing with two 435c.....
435c	7859	Pulley (loose) Flanged Bushing Set Screw
11451	7864	Slide Rod.....
11453	7862	“ “ Collar with two 448c.....
448c	7859	“ “ “ Set Screw.....
2117	7854	“ “ Pin.....
11942	7857	“ “ Spring.....
11453	7862	“ “ “ Collar with two 448c....
448c	7859	“ “ “ “ Set Screw.....
4881	7849	Treadle.....
4882	7860	“ Shaft.....
4883	7865	“ Spring.....
4884	7849	“ Stand.....
4885	7849	Treadle complete, Nos. 4879, 4881 to 4884 and two wood screws 1 in. No. 16.....
11945	—	Belt Shifter complete, Nos. 567D, 4885, 6439, 11446, 11447, 11450, 11451, 11940 to 11942, 58408, 58409 and two each 2117 and 11453.....

## BELT SHIFTER PARTS

## FOR 7-28 MACHINE

NO.	PLATE	NAME
6439	—	Chain, 36 in. to 45 in., with 56864 and 56865.....

NOTE: When ordering 6439, state length required

4879	7860	Chain Connecting Link.....
56864	7860	“ Hook (large).....
56865	7862	“ “ (small).....
11446	7868	“ Eyelet.....
9137	—	“ Pulley.....
10D	7861	“ “ Screw.....
11940	7867	Fork.....
434c	899	“ Set Screw.....
11941	7867	Frame with 8804 and two 434c.....
8804	—	“ Handle.....

## BELT SHIFTER PARTS

NO.	PLATE	NAME
19992	—	Guide Rod.....
3012	7854	“ “ Pin.....
19993	—	Pulley (loose).....
11459	897	“ “ Collar with two 448c.....
448c	7859	“ “ “ Set Screw.....
11451	7864	Slide Rod.....
2117	7854	“ “ Pin.....
11454	7857	“ “ Spring.....
11453	7862	“ “ “ Collar with two 448c....
448c	7859	“ “ “ “ Set Screw.....
4881	7849	Treadle.....
4882	7860	“ Shaft.....
4883	7865	“ Spring.....
4884	7849	“ Stand.....
4885	7849	Treadle complete, Nos. 4879, 4881 to 4884 and two wood screws 1 in. No. 16.....
19994	—	Belt Shifter complete, Nos. 10D, 2117, 3012, 4885, 6439, 9137, 11446, 11451, 11453, 11454, 11459, 11940, 11941 and 19991 to 19993.....

## DRIVING ATTACHMENTS

## FOR MACHINES Nos. 7-38 AND 7-39

NO.	PLATE	NAME
122301	7849	Balance Wheel with two 354c, for 122302
58335	4496	“ “ “ “ “ “ 58336
122302	4496	“ “ 122301 with 11442, 122307, two 1402D and four 401E, for 58379.....
58336	—	Balance Wheel 58335 with 11442, 122307, two 1402D and four 401E, for 58380....
25362	7850	Balance Wheel Ball, size $\frac{3}{8}$ in.....
122303	—	“ “ “ Ring.....
122304	7851	“ “ “ “ 122303 with eighteen 25362.....
122306	7851	Balance Wheel Ball Washer (left).....
122307	7851	“ “ “ “ (right).....
1402D	4494	“ “ “ “ “ Screw
11442	7852	“ “ Friction Washer (paper)...
401E	899	“ “ “ “ Screw....
354c	899	“ “ Set Screw.....
8984	7848	Brake Block (wood).....
9D	898	“ “ Screw.....
11440	7849	Friction Pulley, 7 in. diam., $1\frac{1}{2}$ in. face, with 448c and 11441.....

## DRIVING ATTACHMENTS

NO.	PLATE	NAME
11441	7851	Friction Pulley Centre Bearing.....
448c	7859	“ “ Set Screw.....
19662	906	Lever.....
58378	—	Lever 19662 with 9d, 134d, 8984, 8991, 8992, 19663 and two 497E, for 58379....
58248	7849	Lever.....
58286	—	Lever 58248 with 9d, 134d, 8984, 8991, 8992, 19663 and two 497E, for 58380....
19663	906	Lever Bracket.....
497E	7861	“ “ Bolt with 1522E.....
1522E	7859	“ “ Nut.....
134d	7859	“ Screw.....
8991	7851	“ “ Washer.....
8992	7851	“ Spring.....
14785	4454	“ “ Hook, for machine on top of table.....
19863	4454	Lever Spring Hook, for machine flush with table.....
1520E	7859	Lever Spring Hook Nut.....
6055	4454	“ “ “ Washer.....
9091	7849	Shaft Driving Pulley (sectional) 10 in. diam., 1½ in. face. 1¼ in. bore, with two 597c.....
597c	7861	Shaft Driving Pulley Clamping Screw....
126036	7849	Treadle.....
126205	—	“ Bracket (left).....
126206	7852	Treadle Bracket (left) complete, Nos. 23258, 126205, 126207, 126208 and two wood screws 1 in. No. 14.....
126207	7848	Treadle Bracket (left) Hook.....
23258	7850	“ “ “ “ Friction Washer.....
126208	7850	Treadle Bracket (left) Hook Rivet.....
46681	7867	“ “ (right).....
60502	—	“ “ “ 46681 with two wood screws 1 in. No. 14.....
27637	7847	Treadle Pitman Rod (lower).....
27638	7848	“ “ “ “ Spring.....
6055	4454	“ “ “ “ Washer.....
27639	7847	“ “ “ (upper).....
9079	7847	“ “ “ Clamp with 354c....
354c	899	“ “ “ Screw.....
27640	7847	Treadle Pitman complete, Nos. 2762, 6055, 27637 to 27639 and two 9079.....
2762	4454	Treadle Stop Collar with 362c.....
362c	899	“ “ “ Set Screw.....

## DRIVING ATTACHMENTS

NO.	PLATE	NAME
126209	—	Treadle complete, Nos. 60502, 126036 and 126206.....
126210	—	Treadle and Pitman complete, Nos. 27640 and 126209.....
58379	—	Driving Attachment complete for 58329, for 7-38 Machine, Nos. 1520E, 6055, 9091, 11440, 14785, 58378, 122302, 122304, 122306 and 126210.....
58380	—	Driving Attachment complete for 58334, for 7-39 Machine, Nos. 1520E, 6055, 9091, 11440, 14785, 58286, 58336, 122304, 122306 and 126210.....

## ACCESSORIES

NO.	PLATE	NAME
11361	7848	Bed Bracket (left) with wood screw 1 in. No. 16.....
11360	7848	Bed Bracket (right) with wood screw 1 in. No. 16.....
507E	898	Bed Bracket Bolt with 1515E, for 11360 and 11361.....
1515E	7859	Bed Bracket Bolt Nut.....
120344	4484	Oiler (copper plated) with 120345.....
120345	4484	“ Spout, 5 in. long.....
11831	4484	Screw Driver (large).....
26026	4484	“ “ (small).....
8908	4484	Wrench for 1520.....
8909	4484	“ “ 1513.....
8910	4484	“ “ 1508, 1583, 1588 and 1596....
8911	4484	“ “ 1503.....
23535	4484	“ “ 346, 1528 and 1547.....

## CORDER (Adjustable)

## FOR BUGGY CUSHIONS

NO.	PLATE	NAME
26795	4413	Cord Guide.....
26796	4413	“ “ Arm with 26798 and three 6037.....
1044d	7859	Cord Guide Arm Hinge Screw.....
26797	4413	“ “ Bed.....

NO.	PLATE	NAME
26798	4413	Cord Guide Bracket.....
6037	7850	" " " Rivet.....
190d	899	" " Screw.....
26799	4413	Corder complete, Nos. 190d, 1044d and 26795 to 26797.....
19715	7868	Lifting Presser Foot for 26799.....
14592	7848	Vibrating Presser Bar for 26799.....
26509	4413	" " Foot for 14592.....
19717	7868	" " " " 26799.....

NOTE: Presser Feet are used with, but not included in, No. 26799

## HEMMER ON SLIDE

NO.	PLATE	NAME
120147	7869	Hemmer on Slide 120148 with two 50027d, for heavy duck, for 7-27 and 7-38 Machines.....
50027d	4494	Hemmer Screw.....
120148	—	" Slide.....
120146	—	Cloth Plate for 120147.....

## LAP SEAM FELLERS

NO.	PLATE	NAME
26789	7869	Lap Seam Feller on Shank for 7-28 and 7-39 Machines.....
120182	7869	Lap Seam Feller on Slide 120148 with two 50027d, for 7-27 and 7-38 Machines....
120148	—	Lap Seam Feller Slide.....
50027d	4494	" " " Screw for 120182.....
164d	899	" " " " 26789.....
41544	7862	" " " " Washer for 26789
19718	920	Presser Foot for 26789.....
19799	4419	Feed Dog for 26789, for 7-28 and 7-39 Machines.....
19800	4419	Throat Plate Body.....
19801	4419	" " Needle Hole Strip.....
691d	7859	" " " " Screw....
19802	4419	Throat Plate complete for 19799, Nos. 19800, 19801 and two 691d.....

## BOBBIN WINDERS

### BOBBIN WINDER

(SWINGING AUTOMATIC, RIGHT HAND)  
FOR FLAT OR ROUND BELT, FOR 11910

NO.	PLATE	NAME
41439	3579	Base with 458c, 27916 and two 28084....
41398	3583	Bobbin Carrier Key.....
27916	3583	Brake (leather).....
28084	3583	" Rivet.....
41440	3581	Frame.....
41441	3581	" Hinge Pin.....
458c	3583	" " " Set Screw.....
4784	3583	" Oil Pad (felt).....
41442	3581	" Spring.....
41443	3581	Pulley with 155c.....
155c	901	" Set Screw.....
41444	3579	Spindle with 41398.....
41557	3579	Stop Latch.....
*60630	—	" " 41557 with 2269 and 41446....
41446	3579	" " Hinge Pin.....
2269	3583	" " Pin.....
41447	3581	Tripping Arm with 176d.....
176d	3583	" " Clamping Screw.....
41558	3579	Bobbin Winder, Nos. 41439 to 41444, 41447, 60630, two 4784 and three wood screws 1 in. No. 7.....

### THREAD UNWINDER PARTS

27555	3582	Spool Pin.....
41450	3582	" Rest.....
41451	—	" " 41450 with 138B and 27555....
138B	898	" Set Screw.....
27557	3582	" Stand with 138B.....
41514	3582	" Weight, 4 in. diam., with 41515....
41515	3583	" " Centre Pin.....
2102	3583	Tension Disc.....
1560c	3583	" Regulating Thumb Nut.....
828c	4494	" Screw Stud.....
2103	3583	" Spring.....
5769	3583	" Thread Eyelet.....
17547	4492	" " Guard.....
60608	3582	Thread Guard.....
27560	3582	" " Rod, 26 in. long.....



NO.	PLATE	NAME
138B	898	Thread Guard Rod Set Screw.....
330D	901	“ “ Set Screw.....
60609	—	Thread Guard complete, Nos. 330D, 828C, 1560C, 2103, 5769, 17547, 60608 and two 2102.....
41454	3582	Thread Unwinder complete, for one large spool, Nos. 27557, 27560, 41451, 41514, 60609 and three wood screws 1¼ in. No. 12.....
41559	—	Bobbin Winder (swinging automatic, right hand) complete, Nos. 41454 and 41558.....

**BOBBIN WINDER**

(SWINGING AUTOMATIC, LEFT HAND)  
FOR 43207  
FOR 19991, FOR 7-28 MACHINE

NO.	PLATE	NAME
41894	6781	Base with 449C.....
894D	899	“ Screw.....
60213	7854	Bobbin Position Pin.....
41896	7865	Frame.....
41441	3581	“ Hinge Pin.....
449C	3583	“ “ “ Set Screw.....
4784	3583	“ Oil Pad (felt).....
41897	7865	“ Spring.....
43270	4486	Friction Pulley with 43271, two 448C and ten 15405.....
43271	4486	Friction Pulley Ring (leather).....
15405	4492	“ “ “ Rivet.....
448C	7859	“ “ Set Screw.....
60261	7827	Spindle.....
454C	4494	“ Set Screw.....
60215	4486	“ Shaft with 454C and 60213.....
60262	7827	Stop Latch.....
41446	3579	“ “ Hinge Pin.....
2269	3583	“ “ Pin.....
41899	4486	Tripping Arm with 176D.....
176D	3583	“ “ Clamping Screw.....
60263	7827	Bobbin Winder, Nos. 2269, 41441, 41446, 41894, 41896, 41897, 41899, 43270, 60215, 60261, 60262 and two 4784.....
60264	7867	Bracket.....
50124D	4494	“ Screw.....
9842	4492	“ “ Washer.....

**THREAD UNWINDER PARTS**

NO.	PLATE	NAME
27555	3582	Spool Pin.....
27583	7285	“ Rest.....
27556	—	“ “ 27583 with 138B and two 27555
138B	898	“ “ Set Screw.....
27557	3582	“ Stand with 138B.....
2102	3583	Tension Disc.....
1560C	3583	“ Regulating Thumb Nut.....
828C	4494	“ Screw Stud.....
2103	3583	“ Spring.....
5769	3583	“ Thread Eyelet.....
17547	4492	“ “ Guard.....
60608	3582	Thread Guard.....
27560	3582	“ “ Rod, 26 in. long.....
138B	898	“ “ “ Set Screw.....
330D	901	“ “ Set Screw.....
60609	—	Thread Guard complete, Nos. 330D, 828C, 1560C, 2103, 5769, 17547, 60608 and two 2102.....
41823	7285	Thread Unwinder complete, for two large spools, Nos. 27556, 27557, 27560, 60609 and three wood screws 1¼ in. No. 12..
60265	—	Bobbin Winder (swinging automatic, left hand) complete, Nos. 9842, 41823, 50124D, 60263, 60264 and three 894D...

**BOBBIN WINDER**

(SWINGING AUTOMATIC, LEFT HAND)  
FOR 43207  
FOR 58336, FOR 7-39 MACHINE

This Bobbin Winder is the same as 60265 with  
the following exception:

NO.	PLATE	NAME
60218	7867	Bracket, in place of 60264.....
60266	—	Bobbin Winder (swinging automatic, left hand) complete, Nos. 9842, 41823, 50124D, 60218, 60263 and three 894D...

**BOBBIN WINDER**

(SWINGING AUTOMATIC, LEFT HAND)  
FOR 11910, FOR 7-38 MACHINE

NO.	PLATE	NAME
41894	6781	Base with 449c.....
894b	899	" Screw.....
41895	4492	Bobbin Carrier Key.....
41896	7865	Frame.....
41441	3581	" Hinge Pin.....
449c	3583	" " Set Screw.....
4784	3583	" Oil Pad (felt).....
41897	7865	" Spring.....
43270	4486	Friction Pulley with 43271, two 448c and ten 15405.....
43271	4486	Friction Pulley Ring (leather).....
15405	4492	" " Rivet.....
448c	7859	" " Set Screw.....
41898	6781	Spindle with 41895.....
41557	3579	Stop Latch.....
*60630	—	" " 41557 with 2269 and 41446....
41446	3579	" " Hinge Pin.....
2269	3583	" " Pin.....
41899	4486	Tripping Arm with 176d.....
176d	3583	" " Clamping Screw.....
41900	6781	Bobbin Winder, Nos. 41441, 41894, 41896 to 41899, 43270, 60630 and two 4784....
60271	7852	Bracket.....
50124d	4494	" Screw.....
9842	4492	" Washer.....

**THREAD UNWINDER PARTS**

27555	3582	Spool Pin.....
27583	7285	" Rest.....
27556	—	" " 27583 with 138B and two 27555
138B	898	" " Set Screw.....
27557	3582	" Stand with 138B.....
2102	3583	Tension Disc.....
1560c	3583	" Regulating Thumb Nut.....
828c	4494	" Screw Stud.....
2103	3583	" Spring.....
5769	3583	" Thread Eyelet.....
17547	4492	" " Guard.....
60608	3582	Thread Guard.....
27560	3582	" " Rod, 26 in. long.....
138B	898	" " Set Screw.....
330d	901	" " Set Screw.....

NO.	PLATE	NAME
60609	—	Thread Guard complete, Nos. 330d, 828c, 1560c, 2103, 5769, 17547, 60608 and two 2102.....
41823	7285	Thread Unwinder complete, for two large spools, Nos. 27556, 27557, 27560, 60609 and three wood screws 1¼ in. No. 12....
60272	—	Bobbin Winder (swinging automatic, left hand) complete, Nos. 9842, 41823, 41900, 50124d, 60271 and three 894d....

**BOBBIN WINDER**

(SWINGING AUTOMATIC, LEFT HAND)  
FOR 11910, FOR 7-27 MACHINE

This Bobbin Winder is the same as 60272 with  
the following exception:

NO.	PLATE	NAME
60274	7852	Bracket, in place of 60271.....
60275	—	Bobbin Winder (swinging automatic, left hand) complete, Nos. 9842, 41823, 41900, 50124d, 60274 and three 894d....

**FOOT LIFTER PARTS**

NO.	PLATE	NAME
13351	—	Chain, length 46 in. to 55 in., with 56864 and 56865.....

NOTE: When ordering No. 13351 state length required

4879	7860	Chain Connecting Link.....
56864	7860	" Hook (large).....
56865	7862	" " (small).....
64052	7862	Lifting Collar with 1149c.....
1149c	7859	" " Clamping Screw.....
58311	7858	" Lever.....
8055	7862	" " Hinge Pin.....
19520	7860	" " Spring.....
32d	901	" " Screw.....
4881	7849	Treadle.....
4882	7860	" Shaft.....
4883	7865	" Spring.....
4884	7849	" Stand.....

NO.	PLATE	NAME
4885	7849	Treadle complete, Nos. 4879, 4881 to 4884 and two wood screws 1 in. No. 16.....
1964S	—	Foot Lifter complete for 7-27 and 7-38 Machines, Nos. 32D, 4885, 8055, 13351, 19520, 58311 and 64052.....

## STAND No. 25206

### (ROCKING TREADLE)

NO.	PLATE	NAME
25004	906	Band Wheel (two speed) $11\frac{1}{8}$ in. and $14\frac{3}{16}$ in. diam., with 9296.....
559E	7848	Band Wheel Stud.....
1503E	7850	" " " Nut.....
150D	899	" " " Screw.....
25011	897	" " " Washer.....
25114	897	" " " Washer.....
25012	—	Belt, size $\frac{3}{8}$ in., length $80\frac{1}{2}$ in., with 25030
25030	7850	" Hook.....
25034	1860	Brace with two 46661.....
534E	898	" Bolt with 1510E.....
1510E	7850	" " Nut.....
25061	1860	Leg (left).....
25062	1860	" (right).....
25073	906	Pitman (wood).....
25089	869	" Cotter Pin.....
9296	7850	" Stud.....
11743	7850	" Washer.....
25080	906	Treadle with two each 164D, 25085 and 41544.....
296C	898	Treadle Screw Centre.....
46661	—	" " " 296C with 1507J....
1507J	7859	" " " Nut.....
25085	—	" Strap (leather).....
164D	899	" " Screw.....
41544	7862	" " " Washer.....
25086	906	Wrench for 1507 and 1510.....
25206	—	Stand (iron work) complete, Nos. 150D, 559E, 1503E, 25004, 25011, 25034, 25061, 25062, 25073, 25080, 25086, 25114, two each 11743, 25089 and four 534E.....

## STAND No. 25207

### (ROTARY TREADLE)

NO.	PLATE	NAME
25087	4460	Band Wheel (two speed) 12 in. and 14 in. diam., with 25088.....
8873	7862	Band Wheel Pin.....
25090	4460	" " Shaft.....
25091	7852	" " " Crank with 355c and 25088.....
8873	7862	Band Wheel Shaft Crank Pin.....
355c	901	" " " " Set Screw.....
25013	—	Belt, size $\frac{3}{8}$ in., length $86\frac{1}{2}$ in., with 25030
25030	7850	" Hook.....
25093	4459	Brace with 448c.....
534E	898	" Bolt with 1510E.....
1510E	7850	" " Nut.....
25094	4459	Leg.....
25326	4460	" Stay Rod.....
1588c	7850	" " " Nut.....
25327	4454	" " " " Packing.....
25328	—	Leg Stay Rod complete, Nos. 25326 and two each 1588c and 25327.....
25095	4460	Pitman with four wood screws $1\frac{1}{8}$ in. No. 6 R. H. B.....
25089	869	Pitman Cotter Pin.....
25088	7850	" Stud.....
11743	7850	" Washer.....
25096	7852	Treadle with four 129E.....
129E	901	" Screw.....
25097	4460	" Shaft.....
25098	897	" " Bushing.....
448c	7859	" " " Set Screw.....
25091	7852	" " Crank with 355c and 25088
8873	7862	" " " Pin.....
355c	901	" " " Set Screw.....
25099	897	" " Collar with 448c.....
448c	7859	" " " Set Screw.....
25086	906	Wrench for 1510.....
25207	—	Stand (iron work) complete, Nos. 25086, 25087, 25090, 25093, 25097 to 25099, 25328, two each 25094 to 25096, three 25091 and four each 534E, 8873, 11743 and 25089.....

## TABLE BELT GUIDE

NO.	PLATE	NAME
58263	7852	Bracket with 448c.....
58264	7852	Pulley.....
58265	7852	" Shaft with 58266 and 58267.....
58266	4492	" " Oil Hole Plug.....
58267	—	" " Packing (wick).....
448c	7859	" " Set Screw.....
58268	—	Table Belt Guide complete, for flat belt, for power table, Nos. 58264, 58265, two 58263 and eight wood screws 1½ in. No. 14 R. H. B.....

## THREAD UNWINDER

FOR TWO LARGE SPOOLS OF THREAD  
FOR 5201, FOR 25207

NO.	PLATE	NAME
60636	7852	Holder with 138B.....
27555	3582	Spool Pin.....
27583	7285	" Rest.....
27556	—	" " 27583 with 138B and two 27555 138B 898 " " Set Screw.....
2102	3583	Tension Disc.....
1560c	3583	" Regulating Thumb Nut.....
828c	4494	" Screw Stud.....
2103	3583	" Spring.....
5769	3583	" Thread Eyelet.....
17547	4492	" " Guard.....
60608	3582	Thread Guard.....
27693	7849	" " Rod, 37 in. long.....
138B	898	" " " Set Screw.....
330b	901	" " " Set Screw.....
60609	—	Thread Guard complete, Nos. 330b, 828c, 1560c, 2103, 5769, 17547, 60608 and two 2102.....
60637	—	Thread Unwinder complete, Nos. 27556, 27693, 60609, 60636 and two wood screws 1¼ in. No. 12.....

## NUMERICAL LIST OF PARTS

NO.	PLATE	NAME
9D	898	Driving Attachment Brake Block Screw for 58286 and 58378.....
10D	7861	Belt Shifter Chain Pulley Screw for 19994
16D	899	Lifting Presser Bar Lifter Hinge Screw for 7-27 and 7-38 Machines.....
23D	7859	Feed (upper) Bar Hinge Screw for 7-27 and 7-38 Machines.....
32D	901	Foot Lifter Lifting Lever Spring Screw for 19648.....
32D	901	Shuttle Race Back Spring Screw for 19579
65D	899	Arm Side Cover Hinge Screw.....
65D	899	Feed (upper) Connecting Link Hinge Screw for 7-27 and 7-38 Machines.....
123D	901	Shuttle Race Screw.....
128E	901	Vibrating Presser Bar Cap Bracket Screw (short) for 19963.....
129D	901	Needle Bar Connecting Stud Clamping Screw for 19565.....
129E	901	Treadle Screw for 25096.....
134D	7859	Driving Attachment Lever Screw for 58286 and 58378.....
134D	7859	Feed Lifting Rock Shaft Wearing Block Screw for 58346.....
134D	7859	Feed (lower) Lifting Rock Shaft Wearing Block Screw for 19970.....
134D	7859	Feed (upper) Bar Guide Bracket (upper) Screw (front) for 7-27 and 7-38 Machines
134D	7859	Oil Cup Screw.....
134D	7859	Shuttle Race Ring Screw for 19897.....
138D	898	Thread Unwinder Spool Rest Set Screw for 27556 and 41451.....
138B	898	Thread Unwinder Thread Guard Rod Set Screw for 27557 and 60636.....
145D	899	Feed (upper) Bar Hinge Bracket Adjust- ing Screw for 19674.....
145E	899	Crank Connecting Rod Cap Screw for 11363.....
145F	899	Cloth Plate Screw for 7-28 and 7-39 Ma- chines.....
150D	899	Band Wheel Stud Screw for 25206.....
155c	901	Bobbin Winder Pulley Set Screw for 41443
159D	901	Feed (upper) Bar Guide Bracket (upper) Screw (back) for 7-27 and 7-38 Machines

NO.	PLATE	NAME
161D	901	Face Plate Screw for 7-28 and 7-39 Machines.....
164D	899	Face Plate Thread Guard Screw for 58217
164D	899	Feeding Foot Screw for 7-27 and 7-38 Machines.....
164D	899	Lap Seam Feller Screw for 26789.....
164D	899	Lifting Presser Bar Bell Crank Connecting Stud Cap Screw for 11527.....
164D	899	Oscillating Shaft Crank Slide Block Cap Screw for 19773.....
164D	899	Tension Thread Guard Screw for 7-27 and 7-38 Machines.....
164D	899	Thread Take-up Spring Lever Regulator Screw for 7-27 and 7-38 Machines.....
164D	899	Thread Take-up Spring Regulator Screw for 58217.....
164D	899	Thread Take-up Spring Screw for 58217
164D	899	Treadle Strap Screw for 25080.....
166D	899	Thread Eyelet Screw.....
176D	3583	Bobbin Winder Tripping Arm Clamping Screw for 41447 and 41899.....
180D	901	Thread Retaining Bracket Screw for 7-28 and 7-39 Machines.....
190D	899	Corder Cord Guide Screw for 26799.....
190D	899	Feed (upper) Bar Guide Bracket (lower) Cap Screw for 19671.....
190D	899	Oil Cup Lamp Holder Screw for 7-28 and 7-39 Machines.....
190D	899	Oscillating Shaft Crank Slide Block Cap Screw for 5868.....
190D	899	Vibrating Presser Bar Spring Stud Screw for 7-28 and 7-39 Machines.....
191F	899	Needle Set Screw for 19733, 19734, 19822, 19823, 19825, 19826, 19828 and 19829
207F	901	Oil Cup Cover Latch Spring Screw for 58254.....
207F	901	Oil or Wax Stripper Washer Screw for 58254.....
231C	901	Feed (upper) Regulator Adjusting Screw Stop Screw for 19528.....
257E	7855	Lifting Presser Bar Screw Bushing (lower) for 7-27 and 7-38 Machines.....
257E	7855	Needle Bar Screw Bushing.....
294C	7861	Feed Lifting Rock Shaft Screw Centre for 7-28 and 7-39 Machines.....
294C	7861	Feed Rock Shaft Screw Centre for 7-28 and 7-39 Machines.....

NO.	PLATE	NAME
296C	898	Treadle Screw Centre for 46661.....
307C	898	Feed Bar Screw Centre for 7-28 and 7-39 Machines.....
307C	898	Feed (lower) Bar Screw Centre for 7-27 and 7-38 Machines.....
330D	901	Shuttle (inside) Tension Spring Screw for 43280.....
330D	901	Shuttle (outside) Tension Spring Screw for 43281.....
330D	901	Thread Unwinder Thread Guard Set Screw for 60609.....
335D	7859	Shuttle Race Loop Separator Screw for 19897.....
338D	7855	Arm Spool Bracket Screw.....
346E	7859	Feed Lifting Rock Shaft Crank Clamping Screw for 19812.....
346E	7859	Feed Rock Shaft Crank Clamping Screw for 58235.....
346E	7859	Feed (lower) Lifting Rock Shaft Crank Clamping Screw for 19812.....
346E	7859	Feed (lower) Rock Shaft Crank Clamping Screw for 58235.....
354C	899	Balance Wheel and Pulley (tight) Set Screw for 58407.....
354C	899	Balance Wheel Set Screw for 19991, 58335, 58411 and 122301.....
354C	899	Treadle Pitman Rod Clamp Screw for 9079
355C	901	Band Wheel Shaft Crank Set Screw for 25091.....
355C	901	Treadle Shaft Crank Set Screw for 25091
362C	899	" Stop Collar Set Screw for 2762...
372C	898	Lifting Presser Bar Bell Crank Adjusting Link Roller Screw for 1828.....
381D	899	Feed Dog Screw for 7-28 and 7-39 Machines.....
381D	899	Feed (lower) Dog Screw for 7-27 and 7-38 Machines.....
381D	899	Feed (upper) Bar Hinge Bracket Guide Plate Screw for 7-27 and 7-38 Machines
381D	899	Throat Plate Screw.....
389F	901	Cloth Plate Screw for 7-27 and 7-38 Machines.....
401D	899	Throat Plate Needle Hole Strip Screw for 19593.....
401E	899	Balance Wheel Friction Washer Screw for 58336 and 122302.....
408E	898	Thread Retaining Screw Stud for 11426...

NO.	PLATE	NAME
434c	899	Belt Shifter Fork Set Screw for 11941.....
434c	899	Thread Take-up Cam Set Screw for 11428
435c	7859	Belt Shifter Pulley (loose) Flanged Bushing Set Screw for 58409.....
437c	899	Arm Shaft Bushing Set Screw.....
445c	7859	Feed (upper) Bar Hinge Bracket Set Screw (short) for 19674.....
445c	7859	Feed Cam Set Screw for 11367.....
445c	7859	" (lower) Cam Set Screw for 11367....
445c	7859	" (upper) Cam Set Screw for 19676....
445c	7859	Lifting Presser Bar Bell Crank Connecting Stud Set Screw (small) for 19682.....
445f	7859	Needle Bar Connecting Stud Set Screw for 19565.....
445c	7859	Oscillating Shaft Crank Set Screw for 19892.....
445c	7859	Shuttle Driver Set Screw for 19572 and 19894.....
448c	7859	Belt Shifter Pulley (loose) Collar Set Screw for 11459.....
448c	7859	Belt Shifter Slide Rod Collar Set Screw for 11453.....
448c	7859	Belt Shifter Slide Rod Spring Collar Set Screw for 11453.....
448c	7859	Bobbin Winder Friction Pulley Set Screw for 43270.....
448c	7859	Driving Attachment Friction Pulley Set Screw for 11440.....
448c	7859	Feed (upper) Bar Hinge Bracket Support Screw for 7-27 and 7-38 Machines.....
448c	7859	Table Belt Guide Pulley Shaft Set Screw for 58263.....
448c	7859	Treadle Shaft Bushing Set Screw for 25093
448c	7859	" " Collar Set Screw for 25099
449c	3583	Bobbin Winder Frame Hinge Pin Set Screw for 41894.....
453c	899	Feed (upper) Regulator Set Screw for 19528.....
453c	899	Feed (upper) Regulator Shaft Collar Set Screw for 11393.....
453c	899	Feed (upper) Regulator Shaft Driving Crank Set Screw for 11708.....
453c	899	Feed (upper) Shaft Crank Set Screw for 19678.....
453c	899	Feed (upper) Shaft Driving Crank Set Screw for 19532.....

NO.	PLATE	NAME
453c	899	Oscillating Shaft Crank Set Screw for 19696.....
454c	4494	Bobbin Winder Spindle Set Screw for 60215.....
456c	7859	Feed (upper) Bar Guide Bracket (lower) Set Screw for 19670.....
458c	3583	Bobbin Winder Frame Hinge Pin Set Screw for 41439.....
497E	7861	Driving Attachment Lever Bracket Bolt with 1522E, for 58286 and 58378.....
507E	898	Bed Bracket Bolt with 1515E, for 11360 and 11361 (Accessories).....
523c	901	Lifting Presser Bar Bell Crank Connecting Stud Set Screw (large) for 19682.....
534E	898	Brace Bolt with 1510E, for 25205 and 25207
559E	7848	Band Wheel Stud for 25205.....
564c	898	Feed (lower) Lifting Rock Shaft Screw Centre for 7-27 and 7-38 Machines.....
564c	898	Feed (lower) Rock Shaft Screw Centre for 7-27 and 7-38 Machines.....
565c	898	Crank Connecting Rod Hinge Screw for 7-27 and 7-38 Machines.....
565c	898	Feed Connecting Link Hinge Screw for 7-28 and 7-39 Machines.....
565c	898	Feed (lower) Connecting Link Hinge Screw for 7-27 and 7-38 Machines.....
565c	898	Feed Forked Connection Hinge Screw for 7-28 and 7-39 Machines.....
565c	898	Feed (lower) Forked Connection Hinge Screw for 7-27 and 7-38 Machines.....
566c	898	Needle Bar Connecting Link Hinge Screw
567D	898	Belt Shifter Chain Pulley Screw for 11945
568E	898	Feed Regulator Hinge Screw for 7-28 and 7-39 Machines.....
568E	898	Feed (lower) Regulator Hinge Screw for 7-27 and 7-38 Machines.....
575E	7859	Crank Connecting Rod Cap Screw for 19758.....
590D	901	Shuttle (inside) Cylinder Latch Spring Screw for 19987.....
590D	901	Shuttle (outside) Cylinder Latch Spring Screw for 19988.....
597C	7861	Driving Attachment Shaft Driving Pulley Clamping Screw for 9091.....
611c	7855	Lifting Presser Bar Bell Crank Adjusting Link Screw for 19681 and 7-28 and 7-39 Machines.....

## NUMERICAL LIST OF PARTS

NO.	PLATE	NAME
612E	901	Vibrating Presser Bar Cap Bracket Screw (long) for 19963.....
622c	899	Oscillating Rock Shaft Hinge Pin Screw Bearing for 11842.....
633E	7861	Thread Retaining Screw Stud for 19587..
654c	7861	Oscillating Rock Shaft Hinge Pin Screw Bearing for 19790.....
681D	7859	Vibrating Presser Bar Hinge Screw for 7-28 and 7-39 Machines.....
682D	7859	Vibrating Presser Bar Stop Block Thumb Screw for 7-28 and 7-39 Machines.....
686E	7861	Thread Retaining Screw Stud for 11041..
690D	7859	Vibrating Presser Foot Screw for 7-28 and 7-39 Machines.....
691D	7859	Throat Plate Needle Hole Strip Screw for 19798 and 19802.....
709E	7861	Tension Screw Stud for 19701.....
710E	7861	" " " " 19889.....
774F	4494	Shuttle (inside) Tension Regulating Screw for 19984.....
774F	4494	Shuttle (outside) Tension Regulating Screw for 19985.....
791F	4494	Shuttle (inside) Tension Regulating Screw for 43280.....
791F	4494	Shuttle (outside) Tension Regulating Screw for 43281.....
795c	7861	Feed (upper) Bar Hinge Bracket Set Screw (long) for 19674.....
S28c	4494	Thread Unwinder Tension Screw Stud for 60609.....
S38E	7859	Shuttle (inside) Main Spring Screw for 8861.....
S38E	7859	Shuttle (outside) Main Spring Screw for 8867.....
S58c	7859	Lifting Presser Bar Bell Crank Connecting Stud Set Screw for 11526.....
S74D	4491	Vibrating Presser Bar Stop Block Stop Screw for 58239.....
S85D	7855	Guide Thumb Screw.....
S94D	899	Bobbin Winder Base Screw for 60265, 60266, 60272 and 60275.....
S98D	901	Needle Clamp Screw for 19735, 19824, 19827 and 19830.....
910c	7859	Lifting Presser Bar Lifter Hinge Pin Set Screw for 58217.....
912c	7861	Feed (upper) Regulator Adjusting Screw for 7-27 and 7-38 Machines.....

## NUMERICAL LIST OF PARTS

NO.	PLATE	NAME
913E	7855	Lifting Presser Bar Screw Bushing (upper) for 7-27 and 7-38 Machines.....
949D	4494	Arm Shaft Screw for 7-38 and 7-39 Machines.....
1044D	7859	Corder Cord Guide Arm Hinge Screw for 26799.....
1054c	4421	Oscillating Shaft Crank Slide Block Screw Stud for 5868.....
1149c	7859	Foot Lifter Lifting Collar Clamping Screw for 64052.....
1151c	7861	Crank Connecting Rod Hinge Screw for 7-28 and 7-39 Machines.....
1156c	4406	Oscillating Shaft Crank Slide Block Screw Stud for 19773.....
1177D	4494	Lifting Presser Bar Spring Bracket Screw
1402D	4494	Balance Wheel Ball Washer (right) Screw for 55336 and 122302.....
1497F	4491	Lifting Presser Bar Lifter Bracket Set Screw for 58237.....
1497F	4491	Vibrating Presser Bar Guide Bracket Set Screw for 58239.....
1503E	7850	Band Wheel Stud Nut for 25206.....
1503E	7850	Feed Lifting Rock Shaft Screw Centre Nut for 7-28 and 7-39 Machines.....
1503E	7850	Feed Rock Shaft Screw Centre Nut for 7-28 and 7-39 Machines.....
1503E	7850	Oscillating Rock Shaft Hinge Pin Nut for 19790.....
1503E	7850	Oscillating Rock Shaft Hinge Pin Screw Bearing Nut for 19790.....
1507J	7859	Treadle Screw Centre Nut for 46661.....
1508E	7850	Feed (lower) Lifting Rock Shaft Screw Centre Nut for 7-27 and 7-38 Machines.....
1508E	7850	Feed (lower) Rock Shaft Screw Centre Nut for 7-27 and 7-38 Machines.....
1508E	7850	Oscillating Rock Shaft Hinge Pin Nut for 58293.....
1508E	7850	Oscillating Rock Shaft Hinge Pin Screw Bearing Nut for 11842.....
1508E	7850	Oscillating Shaft Crank Slide Block Screw Stud Nut for 19893.....
1510E	7850	Brace Bolt Nut for 534.....
1513J	7859	Crank Connecting Rod Hinge Screw Nut for 7-27 and 7-38 Machines.....
1513J	7859	Feed Bar Screw Centre Nut for 7-28 and 7-39 Machines.....

## NUMERICAL LIST OF PARTS

NO.	PLATE	NAME
1513J	7859	Feed (lower) Bar Screw Centre Nut for 7-27 and 7-38 Machines.....
1513J	7859	Feed Connecting Link Hinge Screw Nut for 7-28 and 7-39 Machines.....
1513J	7859	Feed (lower) Connecting Link Hinge Screw Nut for 7-27 and 7-38 Machines.....
1513J	7859	Feed Forked Connection Hinge Screw Nut for 7-28 and 7-39 Machines.....
1513J	7859	Feed (lower) Forked Connection Hinge Screw Nut for 7-27 and 7-38 Machines.....
1513J	7859	Needle Bar Connecting Link Hinge Screw Nut.....
1513J	7859	Oscillating Shaft Crank Slide Block Screw Stud Nut for 19696.....
1515E	7859	Bed Bracket Bolt Nut for 507.....
1518E	7859	Feed (upper) Shank Crank Roller and Screw Stud Nut for 19678.....
1518E	7859	Lifting Presser Bar Bell Crank Adjusting Link Roller Screw Nut for 11525 and 19540.....
1518E	7859	Thread Take-up Lever Roller and Screw Stud Nut for 1995.....
1520E	7859	Driving Attachment Lever Spring Hook Nut for 58379 and 58380.....
1520E	7859	Feed (upper) Bar Hinge Bracket Support Screw Nut for 7-27 and 7-38 Machines.....
1522E	7859	Driving Attachment Lever Bracket Bolt Nut for 497.....
1535E	7859	Tension Regulating Thumb Nut for 19701 and 19889.....
1560c	3583	Thread Retaining Regulating Thumb Nut for 11041, 11426 and 19587.....
1560c	3583	Thread Unwinder Tension Regulating Thumb Nut for 60609.....
1583E	7859	Lifting Presser Bar Bell Crank Hinge Screw Nut.....
1588c	7850	Leg Stay Rod Nut for 25328.....
1596d	7859	Feed (upper) Regulator Adjusting Screw Nut for 7-27 and 7-38 Machines.....
1646E	7859	Crank Connecting Rod Hinge Screw Nut for 7-28 and 7-39 Machines.....
1654c	7859	Feeding Foot Screw Nut for 7-27 and 7-38 Machines.....
1654c	7859	Vibrating Presser Foot Screw Nut for 7-28 and 7-39 Machines.....
1804	899	Feed (upper) Regulator Shaft Driving Crank Roller and Stud for 11708.....

## NUMERICAL LIST OF PARTS

NO.	PLATE	NAME
1828	899	Lifting Presser Bar Bell Crank Adjusting Link Roller with 372c, for 11525 and 19540.....
1845	899	Feed (upper) Shaft Crank Roller and Screw Stud for 19678.....
1861	7854	Feed Lifting Rock Shaft Crank Roller and Stud for 19812.....
1861	7854	Feed (lower) Lifting Rock Shaft Crank Roller and Stud for 19812.....
1995	7868	Thread Take-up Lever Roller and Screw Stud with 1518E, for 58302 and 58304..
2022	7854	Feed Lifting Rock Shaft Wearing Block Position Pin for 58346.....
2022	7854	Feed (lower) Lifting Rock Shaft Wearing Block Position Pin for 19970.....
2102	3583	Thread Retaining Disc for 11041, 11426 and 19587.....
2102	3583	Thread Unwinder Tension Disc for 60609
2103	3583	" Retaining Spring for 11041, 11426 and 19587.....
2103	3583	Thread Unwinder Tension Spring for 60609
2117	7854	Belt Shifter Guide Rod Pin for 11945....
2117	7854	" " Slide Rod Pin for 11945 and 19994.....
2117	7854	Feed (upper) Bar Guide Bracket (lower) Pin for 7-27 and 7-38 Machines.....
2117	7854	Feed (upper) Shaft Crank Pin for 7-27 and 7-38 Machines.....
2117	7854	Feed (upper) Shaft Driving Crank Pin for 7-27 and 7-38 Machines.....
2205	7854	Oil Cup Cover Latch Spring for 58254...
2269	3583	Bobbin Winder Stop Latch Pin for 60263 and 60630.....
2718	897	Lifting Presser Bar Bell Crank Adjusting Link Roller Screw Nut Washer for 11525 and 19540.....
2762	4454	Treadle Stop Collar with 362c, for 27640
3012	7854	Belt Shifter Guide Rod Pin for 19994....
3012	7854	Feed (upper) Regulator Pin for 7-27 and 7-38 Machines.....
3012	7854	Feed (upper) Regulator Shaft Driving Crank Pin for 7-27 and 7-38 Machines..
4389	7854	Lifting Presser Bar Spring Guide Pin....
4784	3583	Bobbin Winder Frame Oil Pad (felt) for 41558, 41900 and 60263.....
4879	7860	Chain Connecting Link for 4885.....



## NUMERICAL LIST OF PARTS

NO.	PLATE	NAME
Nos. 4881 to 4884 FOR 4885		
4881	7849	Treadle.....
4882	7860	" Shaft.....
4883	7865	" Spring.....
4884	7849	" Stand.....
4885	7849	Treadle complete for 11945, 19648 and 19994, Nos. 4879, 4881 to 4884 and two wood screws 1 in. No. 16.....
5769	3583	Thread Unwinder Tension Thread Eyelet for 60609.....
5868	4421	Oscillating Shaft Crank Slide Block complete for 16696, Nos. 190b, 1054c, 5968 and 9119.....
5968	7850	Oscillating Shaft Crank Slide Block Cap Screw Washer for 5868.....
6037	7850	Corder Cord Guide Bracket Rivet for 26796.....
6055	4454	Driving Attachment Lever Spring Hook Nut Washer for 58379 and 58380.....
6055	4454	Treadle Pitman Rod (lower) Spring Washer for 27640.....
6312	7866	Thread Retaining Screw Stud Washer for 19587.....
6312	7866	Vibrating Presser Bar Stop Block Thumb Screw Washer for 7-28 and 7-39 Machines.....
6439	—	Belt Shifter Chain, 36 in. to 45 in., with 56864 and 56865, for 11945 and 19994..
8055	7862	Foot Lifter Lifting Lever Hinge Pin for 19648.....
8055	7862	Shuttle Driver Pin for 7-28 and 7-39 Machines.....
8482	7862	Oil or Wax Stripper Washer (steel) for 58253, for 58254.....
8702	7854	Arm Dowel Pin for 7-27 and 7-38 Machines
8760	7850	Lifting Presser Bar Lifter Friction Washer for 7-27 and 7-38 Machines.....
8761	7854	Lifting Presser Bar Lifter Stop Pin for 11909.....
8763	7854	Lifting Presser Bar Lifting Link Hinge Stud for 11909.....
8787	7862	Tension Regulating Thumb Nut Washer for 19701 and 19889.....
8804	—	Belt Shifter Frame Handle for 11941.....
8816	7866	Shuttle (inside) Cover Hinge Pin for 43277
8816	7866	" (outside) Cover Hinge Pin for 43277

## NUMERICAL LIST OF PARTS

NO.	PLATE	NAME
8817	7866	Shuttle (outside) Delivery Eye Thread Guard for 43281.....
8818	7866	Shuttle (inside) Bobbin Retaining Spring Rivet for 8861.....
8818	7866	Shuttle (inside) Delivery Eye Thread Guard Rivet for 43280.....
8818	7866	Shuttle (outside) Bobbin Retaining Spring Rivet for 8867.....
8818	7866	Shuttle (outside) Delivery Eye Thread Guard Rivet for 43281.....
8819	7866	Shuttle (outside) Main Spring for 8867...
8820	7866	" " Tension Spring for 43281
*8861	—	" (inside) Body with 838e, 8864, 16909, 43208 and two 8818, for 43277..
*8863	7866	Shuttle (inside) Delivery Eye Thread Guard for 43280.....
8864	7866	Shuttle (inside) Main Spring for 8861....
8865	7866	" " Tension Spring for 43280
*8867	—	" (outside) Body with 838e, 8819, 16910, 43208 and two 8818, for 43279..
8873	7862	Band Wheel Pin for 25207.....
8873	7862	" " Shaft Crank Pin for 25207..
8873	7862	Oscillating Shaft Crank Pin for 7-28 and 7-39 Machines.....
8873	7862	Shuttle Driver Pin for 7-27 and 7-38 Machines.....
8873	7862	Thread Take-up Cam Pin.....
8873	7862	Treadle Shaft Crank Pin for 25207.....
8879	7862	Tension Friction Washer (cloth) small, for 19701 and 19889.....
8905	7850	Thread Retaining Regulating Thumb Nut Washer for 11041, 11426 and 19587.....
8908	4484	Wrench for 1520 (Accessories).....
8909	4484	" " 1513 (Accessories).....
8910	4484	" " 1508, 1583, 1588 and 1596 (Accessories).....
8911	4484	Wrench for 1503 (Accessories).....
8953	7854	Oil or Wax Stripper (felt) for 58254.....
8961	7866	Shuttle (inside) Cylinder Hinge Pin for 19568.....
8961	7866	Shuttle (outside) Cylinder Hinge Pin for 19569.....
8973	7854	Lifting Presser Bar Lifting Link Hinge Stud Pin for 7-27 and 7-38 Machines...
8984	7848	Driving Attachment Brake Block (wood) for 58286 and 58378.....

## NUMERICAL LIST OF PARTS

NO.	PLATE	NAME
8991	7851	Driving Attachment Lever Screw Washer for 58286 and 58378.....
8992	7851	Driving Attachment Lever Spring for 58286 and 58378.....
9079	7847	Treadle Pitman Rod Clamp with 354c, for 27640.....
9084	7854	Oil Cup Cover Hinge Pin for 58254.....
9091	7849	Shaft Driving Pulley (sectional) 10 in. diam., 1½ in. face, 1⅜ in. bore, with two 597c, for 58379 and 58380.....
9115	7864	Oscillating Rock Shaft Hinge Pin for 19790
9119	4421	“ Shaft Crank Slide Block for 5868.....
9137	—	Belt Shifter Chain Pulley for 19994.....
9296	7850	Pitman Stud for 25004.....
9842	4492	Arm Shaft Screw Washer for 7-38 and 7-39 Machines.....
9842	4492	Bobbin Winder Bracket Screw Washer for 60265, 60266, 60272 and 60275.....
11031	7858	Lifting Presser Bar Spring (flat).....
11041	—	Thread Retainer (short stud) complete for 7-27 and 7-38 Machines, Nos. 686b, 1560c, 2103, 8905 and two 2102.....
11165	897	Oscillating Rock Shaft Oil Pad for 11842 and 19790.....
11241	7848	Tension Friction Washer (cloth) large, for 19701 and 19889.....
11354	7857	Arm Shaft Bushing.....
11360	7848	Bed Bracket (right) with wood screw 1 in. No. 16 (Accessories).....
11361	7848	Bed Bracket (left) with wood screw 1 in. No. 16 (Accessories).....
11363	7856	Crank Connecting Rod with 11364 and two 145b, for 7-27 and 7-38 Machines...
*11364	—	Crank Connecting Rod Cap for 11363....
11367	7857	Feed Cam with two 445c, for 7-28 and 7-39 Machines.....
11367	7857	Feed (lower) Cam with two 445c, for 7-27 and 7-38 Machines.....
11368	7857	Feed Connecting Link for 7-28 and 7-39 Machines.....
11368	7857	Feed (lower) Connecting Link for 7-27 and 7-38 Machines.....
11370	7856	Feed (lower) Forked Connection for 7-27 and 7-38 Machines.....
11375	7857	Feed Regulator for 7-28 and 7-39 Machines

## NUMERICAL LIST OF PARTS

NO.	PLATE	NAME
11375	7857	Feed (lower) Regulator for 7-27 and 7-38 Machines.....
11393	7848	Feed (upper) Regulator Shaft Collar with two 453c, for 7-27 and 7-38 Machines...
11398	7848	Oscillating Rock Shaft Hinge Pin for 58293
11425	7862	Thread Retaining Thread Eyelet for 11426
11426	—	Thread Retainer (long stud) complete for 7-27 and 7-38 Machines, Nos. 408e, 1560c 2103, 8905 and two 2102.....
11428	7867	Thread Take-up Cam (steel) with two 434c
11440	7849	Driving Attachment Friction Pulley, 7 in. diam., 1½ in. face, with 448c and 11441, for 58379 and 58380.....
11441	7851	Driving Attachment Friction Pulley Centre Bearing for 11440.....
11442	7852	Balance Wheel Friction Washer (paper) for 58336 and 122302.....
11446	7868	Belt Shifter Chain Eyelet for 11945 and 19994.....
11447	7865	Belt Shifter Chain Pulley for 11945.....
11450	7864	“ “ Guide Rod for 11945.....
11451	7864	“ “ Slide Rod for 11945 and 19994
11453	7862	“ “ “ “ Collar with two 448c, for 11945.....
11453	7862	Belt Shifter Slide Rod Spring Collar with two 448c, for 11945 and 19994.....
11454	7857	Belt Shifter Slide Rod Spring for 19994...
11459	897	“ “ Pulley (loose) Collar with two 448c, for 19994.....
11523	7865	Lifting Presser Bar Bell Crank for 7-28 and 7-39 Machines.....
11524	7865	Lifting Presser Bar Bell Crank Adjusting Link for 11525.....
11525	—	Lifting Presser Bar Bell Crank Adjusting Link complete for 7-28 and 7-39 Machines, Nos. 1518e, 1828, 2718 and 11524
11526	7854	Lifting Presser Bar Bell Crank Connecting Stud with two 858c, for 11527.....
11527	—	Lifting Presser Bar Bell Crank Connecting Stud complete for 7-28 and 7-39 Machines, Nos. 164d, 11526 and 11528....
11528	7862	Lifting Presser Bar Bell Crank Connecting Stud Cap Screw Washer for 11527.....
11544	7864	Oil Cup Lamp Holder for 7-28 and 7-39 Machines.....
11559	7865	Vibrating Presser Bar Cap Bracket (upper) for 19963.....

NO.	PLATE	NAME
11563	7854	Vibrating Presser Bar Spring Stud with 19877, for 7-28 and 7-39 Machines.....
11564	7854	Vibrating Presser Bar Spring Stud Spring for 7-28 and 7-39 Machines.....
11698	7857	Feed (upper) Shaft for 7-27 and 7-38 Machines.....
11708	7857	Feed (upper) Regulator Shaft Driving Crank with 453c and 1804, for 7-27 and 7-38 Machines.....
11743	7850	Pitman Washer for 25206 and 25207.....
11831	4484	Screw Driver, large (Accessories).....
11833	7850	Shuttle Race Back Position Pin for 19579
*11841	7848	Oscillating Rock Shaft (steel) for 11842..
11842	—	Oscillating Rock Shaft complete for 7-27 and 7-38 Machines, Nos. 622c, 1508e, 11165, 11841 and 58293.....
11848	—	Oscillating Shaft Crank for 19696.....
11853	7866	Shuttle (outside) Cylinder Latch for 19988
11854	7866	" (inside) Cylinder Latch Spring for 19987.....
11854	7866	Shuttle (outside) Cylinder Latch Spring for 19988.....
11867	7860	Lifting Presser Bar Lifter for 58217.....
11874	7860	Thread Take-up Spring for 58217.....
11875	7857	" " " Regulator for 58217
11878	7856	Arm Shaft for 7-27 Machine.....
11909	7860	Lifting Presser Bar Lifter with 8761 and 8763, for 7-27 and 7-38 Machines.....
11910	7866	Shuttle (inside) Bobbin for 19568.....
11910	7866	" (outside) Bobbin for 19569.....
11913	7856	Arm Side Cover for 7-28 and 7-39 Machines
11917	7847	Oil Cup Cover for 58254.....
11918	7854	" or Wax Stripper Washer (steel) for 11917, for 58254.....
11940	7867	Belt Shifter Fork for 11945 and 19994....
11941	7867	" " Frame with 8804 and two 434c, for 11945 and 19994.....
11942	7857	Belt Shifter Slide Rod Spring for 11945...
11945	—	Belt Shifter complete for 7-27 Machine, Nos. 567b, 4885, 6439, 11446, 11447, 11450, 11451, 11940 to 11942, 58408, 58409 and two each 2117 and 11453....
11950	7862	Thread Retaining Thread Eyelet for 11041
12002	7866	Shuttle (inside) Cylinder Latch Pin for 19987.....
12002	7866	Shuttle (outside) Cylinder Latch Pin for 19988.....

NO.	PLATE	NAME
13351	—	Foot Lifter Chain, length 46 in. to 55 in., with 56864 and 56865, for 19648.....
14222	7866	Shuttle (inside) Tension Spring Steady Pin for 43280.....
14222	7866	Shuttle (outside) Tension Spring Steady Pin for 43281.....
14592	7848	Vibrating Presser Bar for 26799.....
14785	4454	Driving Attachment Lever Spring Hook, for machine on top of table, for 58379 and 58380.....
15405	4492	Bobbin Winder Friction Pulley Ring Rivet for 43270.....
16909	7866	Shuttle (inside) Bobbin Retaining Spring for 8861.....
16910	7866	Shuttle (outside) Bobbin Retaining Spring for 8867.....
17547	4492	Thread Unwinder Tension Thread Guard for 60609.....
19520	7860	Foot Lifter Lifting Lever Spring for 19648
19527	7860	Feed (upper) Connecting Link for 7-27 and 7-38 Machines.....
19528	7857	Feed (upper) Regulator with 231c and 453c, for 7-27 and 7-38 Machines.....
19529	7862	Feed (upper) Regulator Adjusting Screw Sleeve for 7-27 and 7-38 Machines.....
19532	869	Feed (upper) Shaft Driving Crank with 453c, for 7-27 and 7-38 Machines.....
19535	7864	Lifting Presser Bar for 19536.....
19536	—	" " " 19535 with 64052, for 7-27 and 7-38 Machines.....
19539	7865	Lifting Presser Bar Bell Crank Adjusting Link for 19540.....
19540	—	Lifting Presser Bar Bell Crank Adjusting Link complete for 19681, Nos. 1518e, 1828, 2718 and 19539.....
*19556	—	Bed for 7-27 and 7-38 Machines.....
*19564	869	Needle Bar Connecting Link for 58203...
19565	869	" " " Stud with 129b and 445f, for 58203.....
19567	7858	Oscillating Shaft for 7-27 and 7-38 Machines.....
19568	866	Shuttle (cylinder, inside) 3 in. diam., complete, for 7-27 and 7-38 Machines, Nos. 8961, 11910, 19984 and 19987.....
19569	866	Shuttle (cylinder, outside) 3 in. diam., complete, for 7-27 and 7-38 Machines, Nos. 8961, 11910, 19985 and 19988....

## NUMERICAL LIST OF PARTS

NO.	PLATE	NAME
19570	867	Shuttle (inside) Cylinder for 19984.....
19571	867	" (outside) Cylinder for 19985.....
19572	864	" Driver with 445c, for 7-27 and 7-38 Machines.....
19573	867	Shuttle (inside) Frame for 19987.....
19574	867	" (outside) Frame for 19988.....
19575	864	" Race Back (inside) for 19579.....
19576	864	" " (outside) for 19579.....
19577	864	" " " Spring for 19579.....
19578	864	" " " Body for 19579.....
19579	—	Shuttle Race complete for 7-27 and 7-38 Machines, Nos. 19575, 19576, 19578, two each 32b, 19577 and four 11833....
19580	866	Shuttle (inside) Tension Spring for 19984
19581	866	" (outside) Tension Spring for 19985
19583	869	Face Plate Thread Eyelet for 58217.....
19584	869	Thread Eyelet (double) top of arm, for 7-28 and 7-39 Machines.....
19585	869	Thread Retaining Bracket for 19587.....
19586	7866	" " Thread Guide Pin for 19587.....
19587	—	Thread Retainer complete for 7-28 and 7-39 Machines, Nos. 19585, 19586, two each 633e, 1560c, 2103, 6312, 8905 and four 2102.....
19590	7854	Face Plate Thread Guard for 58217.....
19591	—	Throat Plate Body for 19593.....
19592	868	" " Needle Hole Strip (right) for 19593.....
19593	868	Throat Plate complete for 58328, Nos. 19591, 19592, 19997 and four 401b.....
19595	7868	Vibrating Presser Foot for 7-28 and 7-39 Machines.....
19614	7854	Thread Take-up Spring Hook for 19691..
19648	—	Foot Lifter complete for 7-27 and 7-38 Machines, Nos. 32b, 4885, 8055, 13351, 19520, 58311 and 64052.....
19662	906	Driving Attachment Lever for 58378.....
19663	906	" " " Bracket for 58286 and 58378.....
19668	911	Arm Side Cover for 7-27 and 7-38 Machines
19669	911	Feed (upper) Bar for 7-27 and 7-38 Ma- chines.....
19670	912	Feed (upper) Bar Guide Bracket (lower) with 456c, for 19671.....

## NUMERICAL LIST OF PARTS

NO.	PLATE	NAME
19671	—	Feed (upper) Bar Guide Bracket (lower) complete for 7-27 and 7-38 Machines, Nos. 19670, 19672 and two 190d.....
19672	912	Feed (upper) Bar Guide Bracket (lower) Cap for 19671.....
Nos. 19673 TO 19679 FOR 7-27 AND 7-38 MACHINES		
19673	911	Feed (upper) Bar Guide Bracket (upper)..
19674	911	" " " Hinge Bracket with 145d, 795c and two 445c.....
19675	911	Feed (upper) Bar Hinge Bracket Guide Plate.....
19676	7857	Feed (upper) Cam with two 445c.....
19677	7857	" " " Regulator Shaft.....
19678	912	" " " Shaft Crank with 453c, 1518e and 1845.....
19679	912	Feeding Foot.....
19680	7865	Lifting Presser Bar Bell Crank for 19681
19681	—	Lifting Presser Bar Bell Crank complete for 7-27 and 7-38 Machines, Nos. 611c, 19540 and 19680.....
19682	913	Lifting Presser Bar Bell Crank Connecting Stud with 445c and 523c, for 7-27 and 7-38 Machines.....
19683	913	Lifting Presser Bar Lifting Link for 7-27 and 7-38 Machines.....
19684	913	Tension Friction Washer (steel) for 19701 and 19889.....
19685	913	Tension Screw Stud Flange for 19701 and 19889.....
19686	913	Tension Spring for 19701 and 19889.....
19687	913	Tension Thread Guard for 7-27 and 7-38 Machines.....
Nos. 19689 TO 19693 FOR 7-27 AND 7-38 MACHINES		
19689	914	Thread Eyelet (double) top of arm.....
19690	914	" Take-up Spring.....
19691	914	" " " Lever with 19614 and 19793.....
19692	914	Thread Take-up Spring Lever Regulator..
19693	914	" " " " Washer....
19694	914	" " " " Hook for 19675..
19695	866	Shuttle (inside) Cylinder Latch for 19987
19696	4421	Oscillating Shaft Crank complete for 7-27 and 7-38 Machines, Nos. 453c, 1513j, 5868 and 11848.....

## NUMERICAL LIST OF PARTS

NO.	PLATE	NAME
19701	—	Tension (wheel) complete for 58217, Nos. 709e, 1535e, 8787, 11241, 19684 to 19686 and two each 8879 and 58795.....
19715	7868	Lifting Presser Foot for 26799.....
19717	7868	Vibrating Presser Foot for 26799.....
19718	920	Presser Foot for 26789.....
19732	911	Needle Bar for 19735.....
19733	914	" Clamp (left) with 191e, for 19735..
19734	914	" " (right) with 191e, for 19735
19735	—	Needle Bar complete, with adjustable clamps, for 7-27 and 7-38 Machines, Nos. 19732 to 19734 and two 898d.....
19747	7856	Arm Shaft for 7-28 Machine.....
*19756	—	Bed for 7-28 and 7-39 Machines.....
19758	4403	Crank Connecting Rod with 19759 and two 575e, for 7-28 and 7-39 Machines.....
*19759	—	Crank Connecting Rod Cap for 19758....
19762	4403	Feed Forked Connection for 7-28 and 7-39 Machines.....
*19768	7867	Oscillating Rock Shaft for 19790.....
19769	7856	" Shaft for 7-28 and 7-39 Machines.....
19771	4406	Oscillating Shaft Crank Slide Block for 19773.....
19772	4406	Oscillating Shaft Crank Slide Block Cap Screw Washer for 19773.....
19773	4406	Oscillating Shaft Crank Slide Block complete for 19893, Nos. 164d, 1156e, 19771 and 19772.....
19776	4408	Shuttle Race Ring (inside) for 19897....
19777	4408	" " " (outside) for 19897....
19784	4403	Vibrating Presser Bar for 7-28 and 7-39 Machines.....
19785	914	Arm Dowel Pin for 7-28 and 7-39 Machines
19786	7858	" Spool Bracket for 19788.....
19787	4403	" " " Spool Pin for 19788..
19788	—	Arm Spool Bracket complete, Nos. 19786 and two 19787.....
19790	—	Oscillating Rock Shaft complete for 7-28 and 7-39 Machines, Nos. 654c, 9115, 11165, 19768 and two 1503e.....
19793	914	Thread Take-up Spring Lever Stop Pin for 19691.....
19795	4431	Feed Dog, for general work, for 7-28 and 7-39 Machines.....
19796	—	Throat Plate Body for 19798.....
19797	4431	" " Needle Hole Strip for 19798

## NUMERICAL LIST OF PARTS

NO.	PLATE	NAME
19798	4431	Throat Plate complete for 19795, Nos. 19796, 19797 and two 691d.....
19799	4419	Feed Dog for 26789, for 7-28 and 7-39 Machines.....
19800	4419	Throat Plate Body for 19802.....
19801	4419	" " Needle Hole Strip for 19802
19802	4419	Throat Plate complete for 19799, Nos. 19800, 19801 and two 691d.....
19812	4421	Feed Lifting Rock Shaft Crank with 346e and 1861, for 58400.....
19812	4421	Feed (lower) Lifting Rock Shaft Crank with 346e and 1861, for 19971.....
Nos. 19821 TO 19830 FOR 7-28 AND 7-39 MACHINES		
19821	7864	Needle Bar for 19824, 19827 and 19830...
19822	7862	" Clamp (left) with 191e, for 19824
19823	7862	" " (right) with 191e, for 19824
19824	—	Needle Bar complete, with adjustable clamps, for $\frac{3}{4}$ in. to $\frac{1}{2}$ in. gauges, Nos. 19821 to 19823 and two 898d.....
19825	7862	Needle Clamp (left) with 191e, for 19827..
19826	7862	" " (right) with 191e, for 19827
19827	—	Needle Bar complete, with adjustable clamps, for $\frac{25}{64}$ in. to $\frac{1}{8}$ in. gauges, Nos. 19821, 19825, 19826 and two 898d.....
19828	7862	Needle Clamp (left) with 191e, for 19830..
19829	7862	" " (right) with 191e, for 19830
19830	—	Needle Bar complete, with adjustable clamps, for $\frac{1}{4}$ in. to $\frac{3}{8}$ in. gauges, Nos. 19821, 19828, 19829 and two 898d.....
19863	4454	Driving Attachment Lever Spring Hook, for machine flush with table, for 58379 and 58380.....
19866	7854	Lifting Presser Bar Lifter Hinge Pin for 58217.....
19877	7854	Vibrating Presser Bar Spring Stud Pin for 11563.....
19886	7854	Thread Take-up Spring Thread Guard for 58217.....
*19887	—	Arm Packing Plate for 7-28 and 7-39 Machines.....
19888	7865	Vibrating Presser Bar Cap Bracket (lower) for 19963.....
19889	—	Tension (wheel) complete for 7-27 and 7-38 Machines, Nos. 710e, 1535e, 8787, 11241, 19684 to 19686 and two each 8879 and 58795.....
19891	7860	Feed Bar for 7-28 and 7-39 Machines....

NO.	PLATE	NAME
Nos. 19892 TO 19897 FOR 7-28 AND 7-39 MACHINES		
19892	—	Oscillating Shaft Crank with 445c, for 19893.....
19893	7865	Oscillating Shaft Crank complete, Nos. 1508e, 19773 and 19892.....
19894	7867	Shuttle Driver with 445c.....
19895	—	“ Race Body for 19897.....
19896	4407	“ “ Loop Separator for 19897... ..
19897	4407	Shuttle Race complete, Nos. 19776, 19777, 19895, 19896, two 335d and six 134d... ..
*19963	—	Arm with 11559, 19888 and two each 128e and 612e, for 7-28 and 7-39 Machines... ..
*19964	—	Arm for 7-27 and 7-38 Machines.....
19967	7857	Feed Lifting Rock Shaft Wearing Block for 58346.....
19967	7857	Feed (lower) Lifting Rock Shaft Wearing Block for 19970.....
19970	7847	Feed (lower) Lifting Rock Shaft with 134d, 2022 and 19967, for 19971.....
19971	—	Feed (lower) Lifting Rock Shaft complete for 7-27 and 7-38 Machines, Nos. 19812 and 19970.....
*19984	—	Shuttle (inside) Cylinder 19570 with 774f and 19580, for 19568.....
*19985	—	Shuttle (outside) Cylinder 19571 with 774f and 19581, for 19569.....
*19987	—	Shuttle (inside) Frame 19573 with 590b, 11854, 12002 and 19695, for 19568.....
*19988	—	Shuttle (outside) Frame 19574 with 590b, 11853, 11854 and 12002, for 19569.....
19991	4496	Balance Wheel and Pulley (tight) with two 354c, for 19994.....
19992	—	Belt Shifter Guide Rod for 19994.....
19993	—	“ “ Pulley (loose) for 19994.....
19994	—	Belt Shifter complete for 7-28 Machine, Nos. 10b, 2117, 3012, 4885, 6439, 9137, 11446, 11451, 11453, 11454, 11459, 11940, 11941 and 19991 to 19993.....
19997	—	Throat Plate Needle Hole Strip (left) for 19593.....
23258	7850	Treadle Bracket (left) Hook Friction Washer for 126206.....
23535	4484	Wrench for 346, 1528 and 1547 (Accessories).....
25004	906	Band Wheel (two speed) 11 $\frac{1}{8}$ in. and 14 $\frac{1}{8}$ in. diam., with 9296, for 25206.....

NO.	PLATE	NAME
25011	897	Band Wheel Stud Screw Washer for 25206
25012	—	Belt, size $\frac{3}{8}$ in., length 80 $\frac{1}{2}$ in., with 25030, for 25206.....
25013	—	Belt, size $\frac{3}{8}$ in., length 86 $\frac{1}{2}$ in., with 25030, for 25207.....
25030	7850	Belt Hook for 25012 and 25013.....
25034	1860	Brace with two 46661, for 25206.....
25061	1860	Leg (left) for 25206.....
25062	1860	“ (right) for 25206.....
25073	906	Pitman (wood) for 25206.....
25080	906	Treadle with two each 164d, 25085 and 41544, for 25206.....
25085	—	Treadle Strap (leather) for 25080.....
25086	906	Wrench for 1507 and 1510, for 25206 and 25207.....
25087	4460	Band Wheel (two speed) 12 in. and 14 in. diam., with 25088, for 25207.....
25088	7850	Pitman Stud for 25087 and 25091.....
25089	869	“ Cotter Pin for 25206 and 25207.. ..
25090	4460	Band Wheel Shaft for 25207.....
25091	7852	“ “ “ Crank with 355c and 25088, for 25207.....
25091	7852	Treadle Shaft Crank with 355c and 25088, for 25207.....
Nos. 25093 TO 25099 FOR 25207		
25093	4459	Brace with 448c.....
25094	4459	Leg.....
25095	4460	Pitman with four wood screws 1 $\frac{1}{8}$ in. No. 6 R. H. B. ....
25096	7852	Treadle with four 129e.....
25097	4460	“ Shaft.....
25098	897	“ “ Bushing.....
25099	897	“ “ Collar with 448c.....
25114	897	Band Wheel Stud Washer for 25206.....
25206	—	Stand (iron work) rocking treadle, complete, Nos. 150b, 559b, 1503e, 25004, 25011, 25034, 25061, 25062, 25073, 25080, 25086, 25114, two each 11743, 25089 and four 534e.....
25207	—	Stand (iron work) rotary treadle, complete, Nos. 25086, 25087, 25090, 25093, 25097 to 25099, 25328, two each 25094 to 25096, three 25091 and four each 534e, 8873, 11743 and 25089.....
25326	4460	Leg Stay Rod for 25328.....
25327	4454	“ “ “ Nut Packing for 25328....

## NUMERICAL LIST OF PARTS

NO.	PLATE	NAME
25328	—	Leg Stay Rod complete for 25207, Nos. 25326 and two each 1588c and 25327.
25362	7850	Balance Wheel Ball, size $\frac{3}{16}$ in., for 122304
26026	4484	Screw Driver, small (Accessories)
26176	7863	Guide (6 in. face) for 7-28 and 7-39 Machines
26419	7863	Guide (6 in. face) for 7-27 and 7-38 Machines
26509	4413	Vibrating Presser Foot for 14592
26789	7869	Lap Seam Feller on Shank for 7-28 and 7-39 Machines
26795	4413	Corder Cord Guide for 26799
26796	4413	“ “ “ Arm with 26798 and three 6037, for 26799
26797	4413	Corder Cord Guide Bed for 26799
26798	4413	“ “ “ Bracket for 26796
26799	4413	Corder (adjustable) complete, for buggy cushions, Nos. 190b, 1044d and 26795 to 26797
27555	3582	Thread Unwinder Spool Pin for 27556 and 41451
27556	—	Thread Unwinder Spool Rest 27583 with 138B and two 27555, for 41823 and 60637
27557	3582	Thread Unwinder Spool Stand with 138B, for 41454 and 41823
27560	3582	Thread Unwinder Thread Guard Rod, 26 in. long, for 41454 and 41823
27583	7285	Thread Unwinder Spool Rest for 27556
27637	7847	Treadle Pitman Rod (lower) for 27640
27638	7848	“ “ “ Spring for 27640
27639	7847	Treadle Pitman Rod (upper) for 27640
27640	7847	Treadle Pitman complete for 126210, Nos. 2762, 6055, 27637 to 27639 and two 9079
27693	7849	Thread Unwinder Thread Guard Rod, 37 in. long, for 60637
27916	3583	Bobbin Winder Brake (leather) for 41439
28084	3583	“ “ “ Rivet for 41439
40025	4492	Oscillating Shaft Crank Pin for 7-27 and 7-38 Machines
41398	3583	Bobbin Winder Bobbin Carrier Key for 41444
41439	3579	Bobbin Winder Base with 458c, 27916 and two 28084, for 41558
41440	3581	Bobbin Winder Frame for 41558
41441	3581	“ “ “ Hinge Pin for 41558, 41900 and 60263

## NUMERICAL LIST OF PARTS

NO.	PLATE	NAME
41442	3581	Bobbin Winder Frame Spring for 41558
41443	3581	“ “ Pulley with 155c, for 41558
41444	3579	“ “ Spindle with 41398, for 41558
41446	3579	Bobbin Winder Stop Latch Hinge Pin for 60263 and 60630
41447	3581	Bobbin Winder Tripping Arm with 176b, for 41558
41450	3582	Thread Unwinder Spool Rest for 41451
41451	—	“ “ “ “ 41450 with 138B and 27555, for 41454
41454	3582	Thread Unwinder complete, for one large spool, for 41559, Nos. 27557, 27560, 41451, 41514, 60609 and three wood screws $1\frac{1}{4}$ in. No. 12
41514	3582	Thread Unwinder Spool Weight, 4 in. diam., with 41515, for 41454
41515	3583	Thread Unwinder Spool Weight Centre Pin for 41514
41544	7862	Lap Seam Feller Screw Washer for 26789
41544	7862	Tension Thread Guard Screw Washer for 7-27 and 7-38 Machines
41544	7862	Thread Take-up Spring Lever Regulator Screw Washer for 7-27 and 7-38 Machines
41544	7862	Thread Take-up Spring Screw Washer for 58217
41544	7862	Treadle Strap Screw Washer for 25080
41557	3579	Bobbin Winder Stop Latch for 60630
41558	3579	“ “ “ for 41559, Nos. 41439 to 41444, 41447, 60630, two 4784 and three wood screws 1 in. No. 7
41559	—	Bobbin Winder (swinging automatic, right hand) complete, for flat or round belt, for 11910, Nos. 41454 and 41558
41823	7285	Thread Unwinder complete, for two large spools, for 60265, 60266, 60272 and 60275, Nos. 27556, 27557, 27560, 60609 and three wood screws $1\frac{1}{4}$ in. No. 12
41894	6781	Bobbin Winder Base with 449c, for 41900 and 60263
41895	4492	Bobbin Winder Bobbin Carrier Key for 41898
41896	7865	Bobbin Winder Frame for 41900 and 60263
41897	7865	“ “ “ Spring for 41900 and 60263

NO.	PLATE	NAME
41898	6781	Bobbin Winder Spindle with 41895, for 41900.....
41899	4486	Bobbin Winder Tripping Arm with 176D, for 41900 and 60263.....
41900	6781	Bobbin Winder for 60272 and 60275, Nos. 41441, 41894, 41896 to 41899, 43270, 60630 and two 4784.....
43207	7866	Shuttle (inside) Bobbin for 43277.....
43207	7866	" (outside) Bobbin for 43279.....
43208	7866	" (inside) Main Spring Steady Pin for 8861.....
43208	7866	Shuttle (outside) Main Spring Steady Pin for 8867.....
43263	4492	Arm Screw Washer for 7-28 and 7-39 Machines.....
43267	4492	Lifting Presser Bar Lifting Link Hinge Stud Washer for 7-27 and 7-38 Machines.....
43270	4486	Bobbin Winder Friction Pulley with 43271, two 448c and ten 15405, for 41900 and 60263.....
43271	4486	Bobbin Winder Friction Pulley Ring (leather) for 43270.....
*43276	—	Shuttle (inside) Cover for 43280.....
43277	7820	Shuttle (inside) complete for 7-28 and 7-39 Machines, Nos. 8816, 8861, 43207 and 43280.....
*43278	—	Shuttle (outside) Cover for 43281.....
43279	7820	Shuttle (outside) complete for 7-28 and 7-39 Machines, Nos. 8816, 8867, 43207 and 43281.....
*43280	—	Shuttle (inside) Cover 43276 with 330D, 791F, 8818, 8863, 8865 and 14222, for 43277.....
*43281	—	Shuttle (outside) Cover 43278 with 330D, 791F, 8817, 8818, 8820 and 14222, for 43279.....
46661	—	Treadle Screw Centre 296c with 1507J, for 25034.....
46681	7867	Treadle Bracket (right) for 60502.....
50027D	4494	Hemmer Screw for 120147.....
50027D	4494	Lap Seam Feller Screw for 120182.....
50124D	4494	Bobbin Winder Bracket Screw for 60265, 60266, 60272 and 60275.....
50206D	7855	Lifting Presser Bar Bell Crank Hinge Screw.....
50322D	7855	Feed Regulator Thumb Screw for 7-28 and 7-39 Machines.....

NO.	PLATE	NAME
50322D	7855	Feed (lower) Regulator Thumb Screw for 7-27 and 7-38 Machines.....
50323D	7855	Lifting Presser Bar Spring Regulating Thumb Screw.....
50347E	4494	Arm Screw for 7-28 and 7-39 Machines.....
50348E	7855	" " " 7-27 and 7-38 Machines.....
50437D	4494	Thread Take-up Lever Hinge Screw for 58312 and 58316.....
56864	7860	Foot Lifter Chain Hook (large) for 6439 and 13351.....
56865	7862	Foot Lifter Chain Hook (small) for 6439 and 13351.....
58203	—	Needle Bar Connecting Stud 19565 with 19564.....
58216	7858	Face Plate for 58217.....
58217	—	Face Plate complete for 7-28 and 7-39 Machines, Nos. 910c, 11867, 11874, 11875, 19583, 19590, 19701, 19866, 19886, 41544, 58216 and three 164D....
58218	7858	Cloth Plate with 58219, 58220 and four 58221, for 7-27 and 7-38 Machines.....
*58219	—	Cloth Plate Packing (back) for 58218....
*58220	—	" " " (front) for 58218....
58221	4492	" " " Rivet for 58218.....
58224	7858	" " with 58225, 58226 and four 58227, for 7-28 and 7-39 Machines.....
*58225	—	Cloth Plate Packing (back) for 58224....
*58226	—	" " " (front) for 58224....
58227	4492	" " " Rivet for 58224.....
58233	7847	Feed Rock Shaft for 58234.....
58233	7847	" (lower) Rock Shaft for 58234.....
58234	—	Feed Rock Shaft complete for 7-28 and 7-39 Machines, Nos. 58233 and 58235..
58234	—	Feed (lower) Rock Shaft complete for 7-27 and 7-38 Machines, Nos. 58233 and 58235
58235	4491	Feed Rock Shaft Crank with 346E, for 58234.....
58235	4491	Feed (lower) Rock Shaft Crank with 346E, for 58234.....

Nos. 58236 TO 58240 FOR 7-28 AND 7-39 MACHINES

58236	7864	Lifting Presser Bar.....
58237	4491	" " " Lifter Bracket with 1497F and 58238.....
58238	4491	Lifting Presser Bar Lifter Bracket Spring Bearing for 58237.....



## NUMERICAL LIST OF PARTS

NO.	PLATE	NAME
58239	4491	Vibrating Presser Bar Guide Bracket with 874d and 1497F.....
58240	4491	Vibrating Presser Bar Stop Block.....
58248	7849	Driving Attachment Lever for 58286.....
58252	7851	Lifting Presser Bar Spring Bracket.....
58253	—	Oil Cup for 58254.....
58254	7847	Oil Cup complete, Nos. 2205, 8482, 9084, 11917, 11918, 58253, two 8953 and three 207F.....
58263	7852	Table Belt Guide Bracket with 448c, for 58268.....
58264	7852	Table Belt Guide Pulley for 58268.....
58265	7852	“ “ “ “ Shaft with 58266 and 58267, for 58268.....
58266	4492	Table Belt Guide Pulley Shaft Oil Hole Plug for 58265.....
58267	—	Table Belt Guide Pulley Shaft Packing (wick) for 58265.....
58268	—	Table Belt Guide complete, for flat belt, for power table, Nos. 58264, 58265, two 58263 and eight wood screws 1½ in. No. 14 R. H. B.....
58277	4492	Shuttle Race Dowel Pin.....
58286	—	Driving Attachment Lever 58248 with 9d, 134d, 8984, 8991, 8992, 19663 and two 497E, for 58380.....
*58293	—	Oscillating Rock Shaft Hinge Pin 11398 with 1508E, for 11842.....
58301	7860	Thread Take-up Lever for 58302.....
58302	—	“ “ “ “ 58301 with 1995, for 58316.....
58303	7860	Thread Take-up Lever for 58304.....
58304	—	“ “ “ “ 58303 with 1995, for 58312.....
58311	7858	Foot Lifter Lifting Lever for 19648.....
58312	—	Thread Take-up Lever 58304 with 50437d, for 7-28 and 7-39 Machines.....
58316	—	Thread Take-up Lever 58302 with 50437d, for 7-27 and 7-38 Machines.....
58319	4492	Thread Take-up Cam Washer for 7-28 and 7-39 Machines.....
58327	7860	Feed (lower) Bar for 7-27 and 7-38 Machines.....
58328	4498	Feed (lower) Dog for 7-27 and 7-38 Machines.....
58329	7847	Arm Shaft for 7-38 Machine.....
58334	7856	“ “ “ “ 7-39 Machine.....

## NUMERICAL LIST OF PARTS

NO.	PLATE	NAME
58335	4496	Balance Wheel with two 354c, for 58336..
58336	—	“ “ “ “ 58335 with 11442, 122307, two 1402d and four 401E, for 58380....
58346	7856	Feed Lifting Rock Shaft with 134d, 2022 and 19967, for 58400.....
58378	—	Driving Attachment Lever 19662 with 9d, 134d, 8984, 8991, 8992, 19663 and two 497E, for 58379.....
58379	—	Driving Attachment complete for 58329, for 7-38 Machine, Nos. 1520E, 6055, 9091, 11440, 14785, 58378, 122302, 122304, 122306 and 126210.....
58380	—	Driving Attachment complete for 58334, for 7-39 Machine, Nos. 1520E, 6055, 9091, 11440, 14785, 58286, 58336, 122304, 122306 and 126210.....
58400	—	Feed Lifting Rock Shaft complete for 7-28 and 7-39 Machines, Nos. 19812 and 58346
58407	7849	Balance Wheel and Pulley (tight) with two 354c, for 7-27 and 7-38 Machines..
58408	—	Belt Shifter Pulley (loose) for 11945.....
58409	7865	“ “ “ “ Flanged Bushing with two 435c, for 11945.....
58411	7849	Balance Wheel (grooved) 4¼ in. diam., with two 354c, for 7-27 Machine....
58795	7854	Tension Wheel for 19701 and 19889.....
60213	7854	Bobbin Winder Bobbin Position Pin for 60215.....
60215	4486	Bobbin Winder Spindle Shaft with 454c and 60213, for 60263.....
60218	7867	Bobbin Winder Bracket for 60266.....
60261	7827	“ “ “ “ Spindle for 60263.....
60262	7827	“ “ “ “ Stop Latch for 60263....
60263	7827	Bobbin Winder for 60265 and 60266, Nos. 2269, 41441, 41446, 41894, 41896, 41897, 41899, 43270, 60215, 60261, 60262 and two 4784.....
60264	7867	Bobbin Winder Bracket for 60265.....
60265	—	Bobbin Winder (swinging automatic, left hand) complete for 43207, for 19991, for 7-28 Machine, Nos. 9842, 41823, 50124d, 60263, 60264 and three 894d.....
60266	—	Bobbin Winder (swinging automatic, left hand) complete for 43207, for 58336, for 7-39 Machine, Nos. 9842, 41823, 50124d, 60218, 60263 and three 894d.....
60271d	7852	Bobbin Winder Bracket for 60272.....

NO.	PLATE	NAME
60272	—	Bobbin Winder (swinging automatic, left hand) complete for 11910, for 122302, for 7-38 Machine, Nos. 9842, 41823, 41900, 50124d, 60271 and three 894d...
60274	7852	Bobbin Winder Bracket for 60275.....
60275	—	Bobbin Winder (swinging automatic, left hand) complete for 11910, for 58411, for 7-27 Machine, Nos. 9842, 41823, 41900, 50124d, 60274 and three 894d.....
60502	—	Treadle Bracket (right) 46681 with two wood screws 1 in. No. 14, for 126209..
60608	3582	Thread Unwinder Thread Guard for 60609
60609	—	Thread Unwinder Thread Guard complete for 41454, 41823 and 60637, Nos. 330d, 828c, 1560c, 2103, 5769, 17547, 60608 and two 2102.....
*60630	—	Bobbin Winder Stop Latch 41557 with 2269 and 41446, for 41558 and 41900..
60636	7852	Thread Unwinder Holder with 138b, for 60637.....
60637	—	Thread Unwinder complete, for two large spools of thread, for 5201, for 25207, Nos. 27556, 27693, 60609, 60636 and two wood screws 1¼ in. No. 12.....
64052	7862	Foot Lifter Lifting Collar with 1149c, for 19648.....
120146	—	Cloth Plate for 120147.....
120147	7869	Hemmer on Slide 120148 with two 50027d, for heavy duck, for 7-27 and 7-38 Machines.....
120148	—	Hemmer Slide for 120147.....
120148	—	Lap Seam Feller Slide for 120182.....
120182	7869	Lap Seam Feller on Slide 120148 with two 50027d, for 7-27 and 7-38 Machines....
120344	4484	Oiler (copper plated) with 120345 (Accessories).....
120345	4484	Oiler Spout, 5 in. long, for 120344.....
122301	7849	Balance Wheel with two 354c, for 122302
122302	4496	" " 122301 with 11442, 122307, two 1402d and four 401e, for 58379....
122303	—	Balance Wheel Ball Ring for 122304.....
122304	7851	" " " " 122303 with eighteen 25362, for 58379 and 58380...
122306	7851	Balance Wheel Ball Washer (left) for 58379 and 58380.....
122307	7851	Balance Wheel Ball Washer (right) for 58336 and 122302.....

NO.	PLATE	NAME
126036	7849	Driving Attachment Treadle for 126209..
126205	—	" " " Bracket (left) for 126206.....
126206	7852	Driving Attachment Treadle Bracket (left) complete for 126209, Nos. 23258, 126205, 126207, 126208 and two wood screws 1 in. No. 14.....
126207	7848	Driving Attachment Treadle Bracket (left) Hook for 126203.....
126208	7850	Driving Attachment Treadle Bracket (left) Hook Rivet for 126206.....
126209	—	Driving Attachment Treadle complete for 126210, Nos. 60502, 126036 and 126206
126210	—	Driving Attachment Treadle and Pitman complete for 58379 and 58380, Nos. 27640 and 126209.....

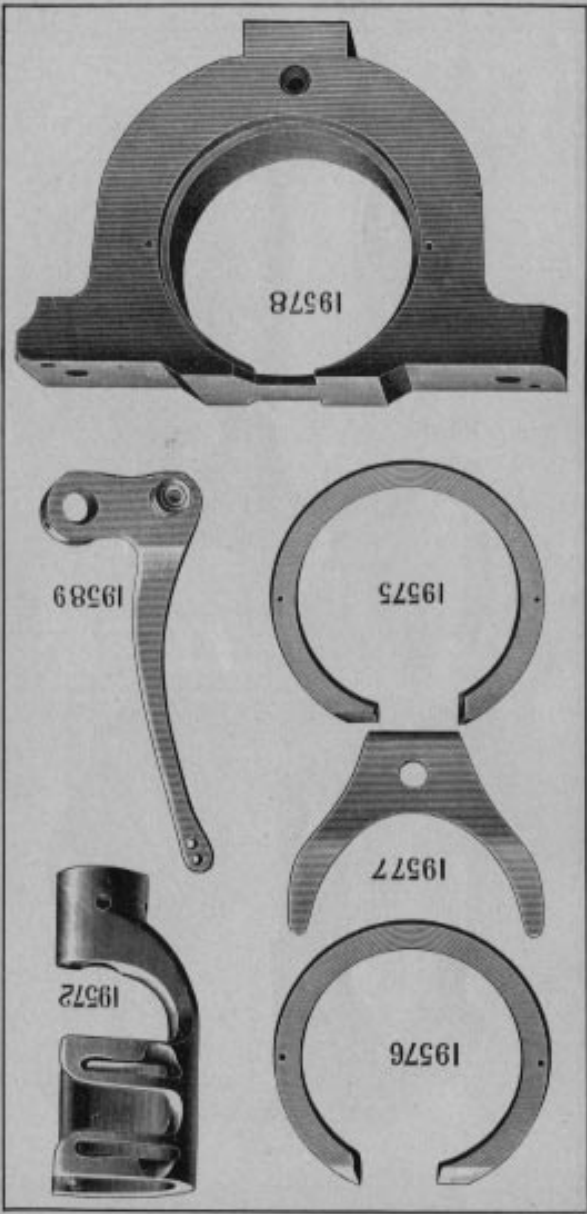

PLATE 864-ONE-HALF SIZE

PLATE 866—FULL SIZE

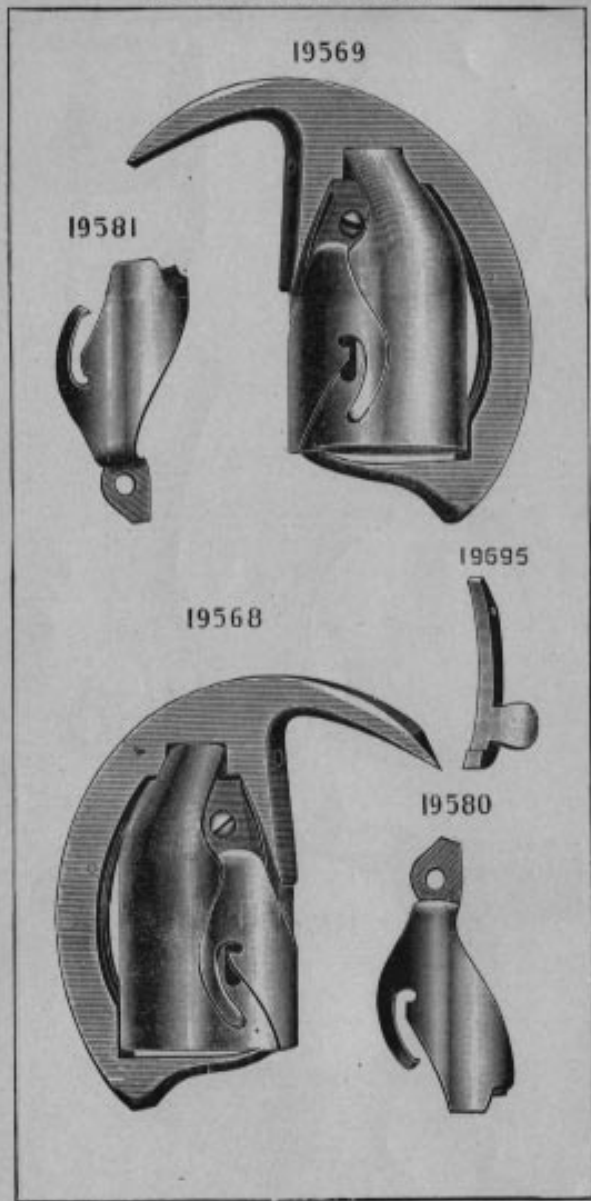

PLATE 867—FULL SIZE

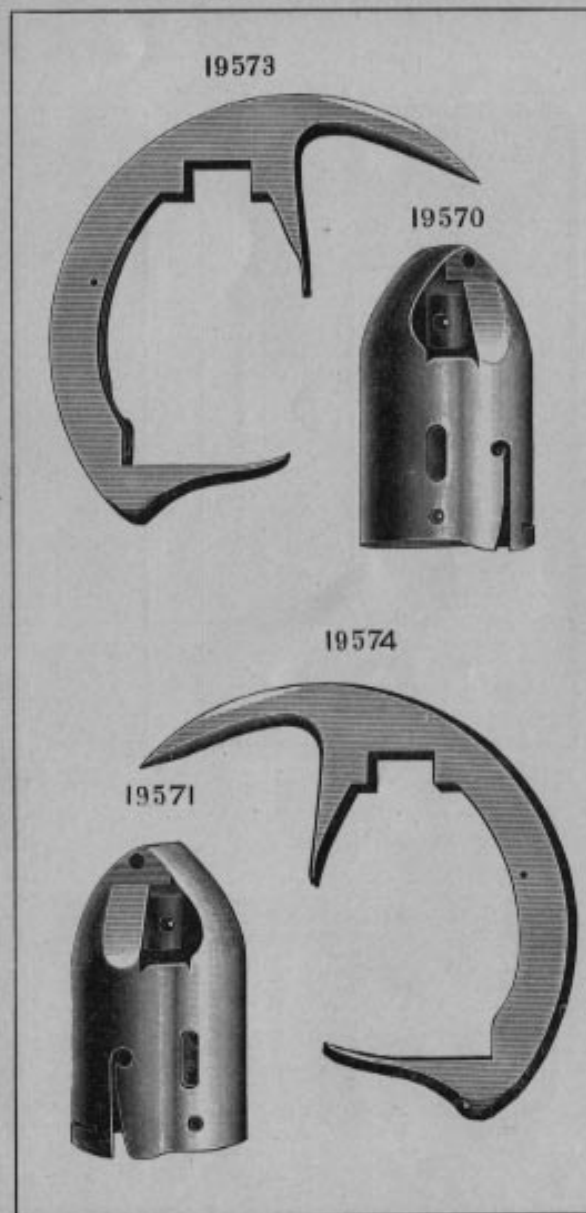
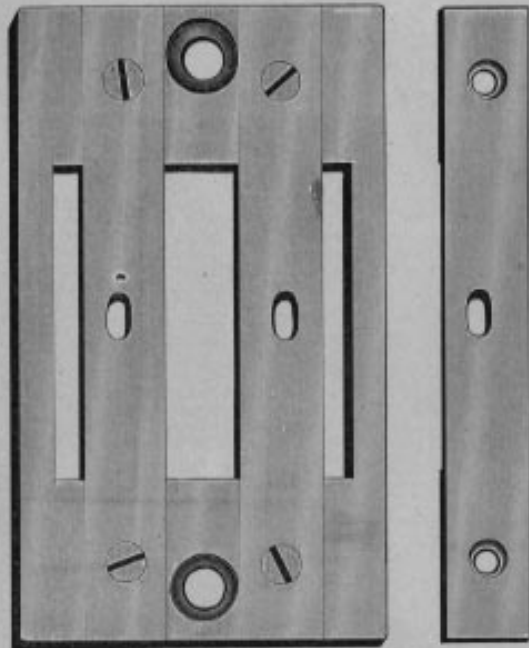

PLATE 868—FULL SIZE

19593

19592



19580

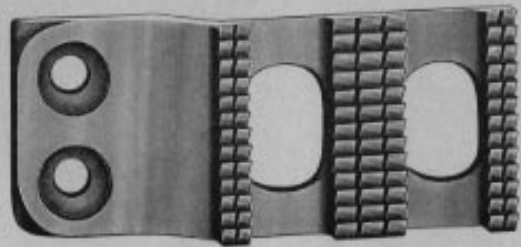
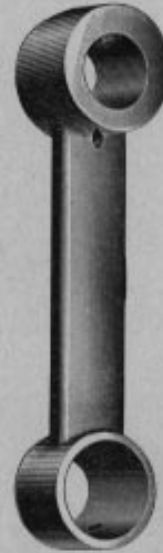

PLATE 869—FULL SIZE

19583

19532

19564



25089



19584

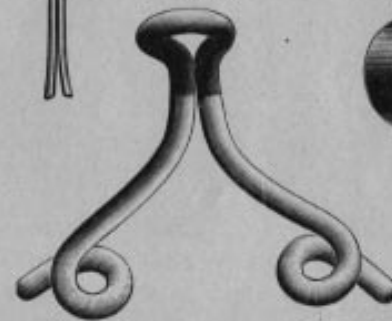

19585

19565



PLATE 897—FULL SIZE

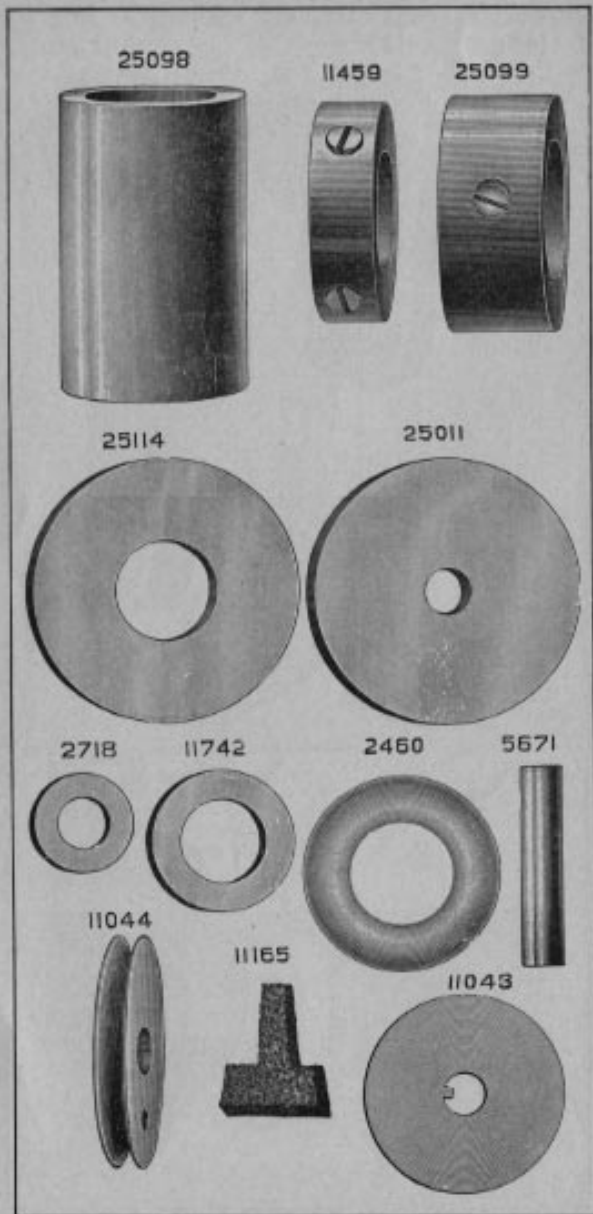

PLATE 898—FULL SIZE

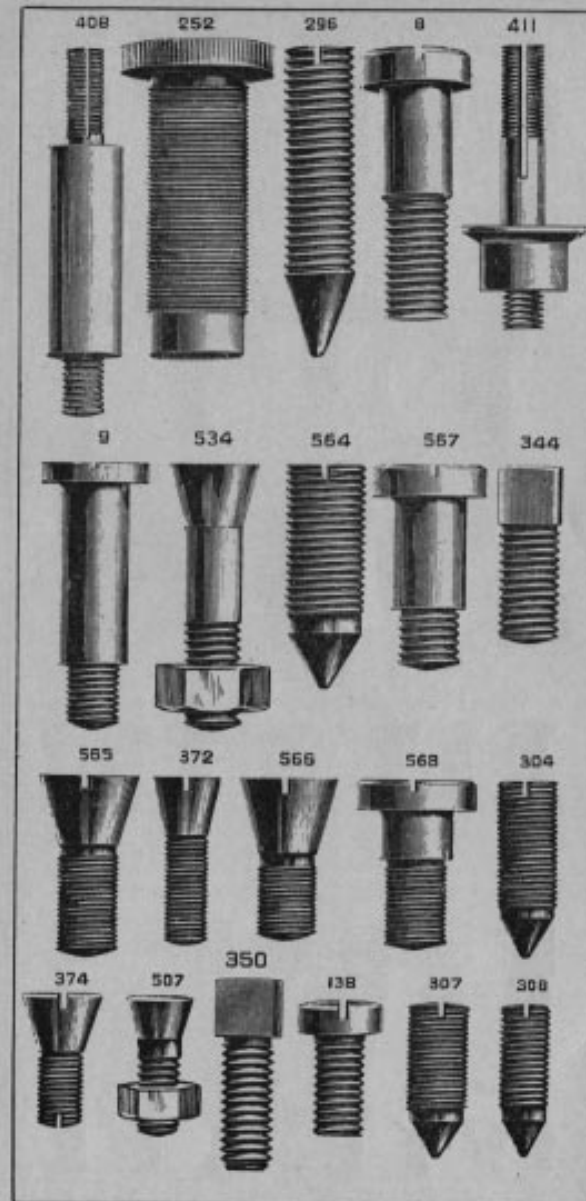

PLATE 899—FULL SIZE

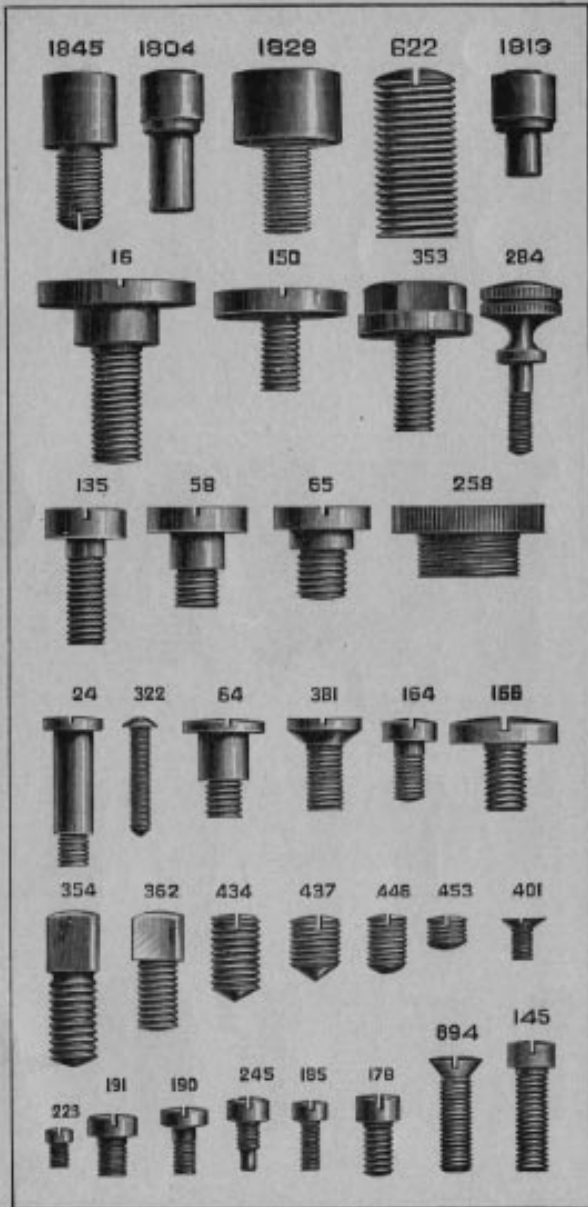

PLATE 901—FULL SIZE

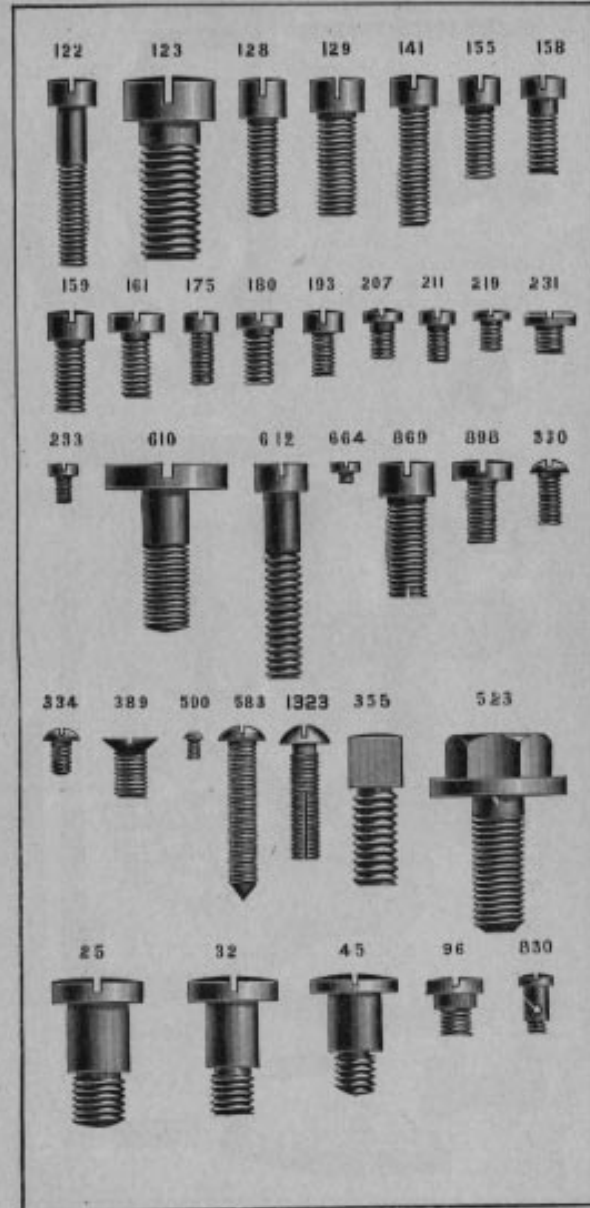

PLATE 906—ONE-NINTH SIZE

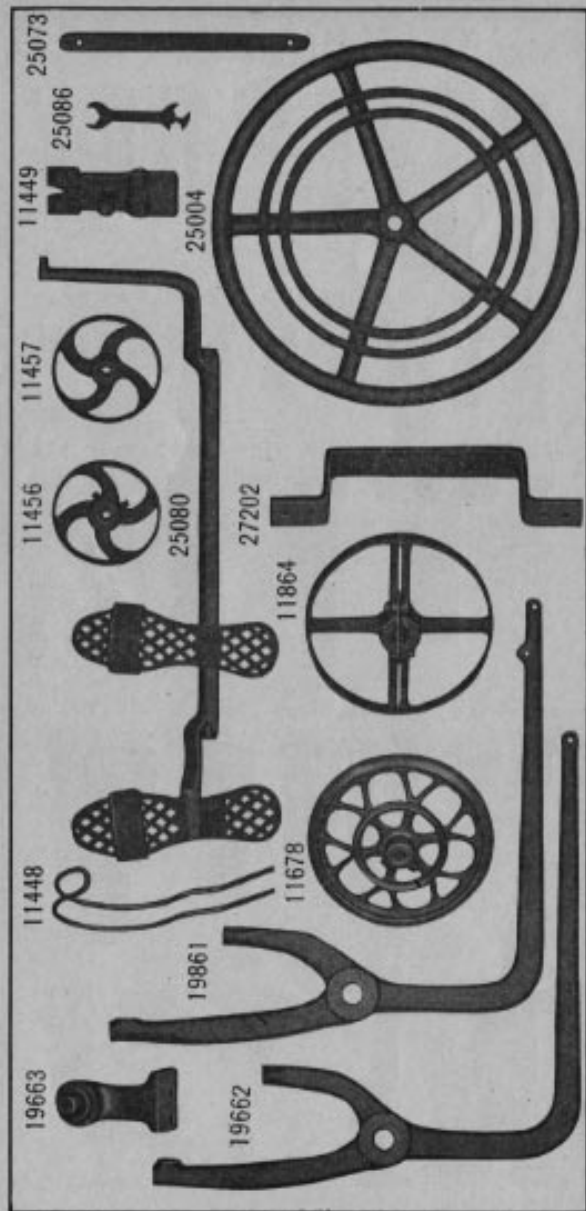

PLATE 911—ONE-HALF SIZE

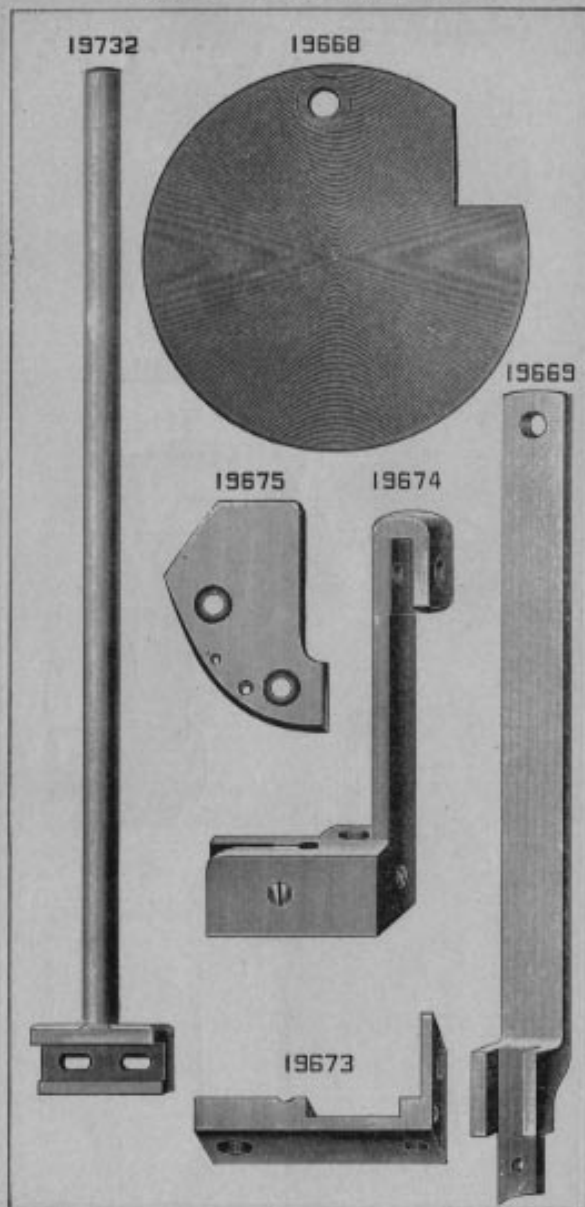



PLATE 912—FULL SIZE

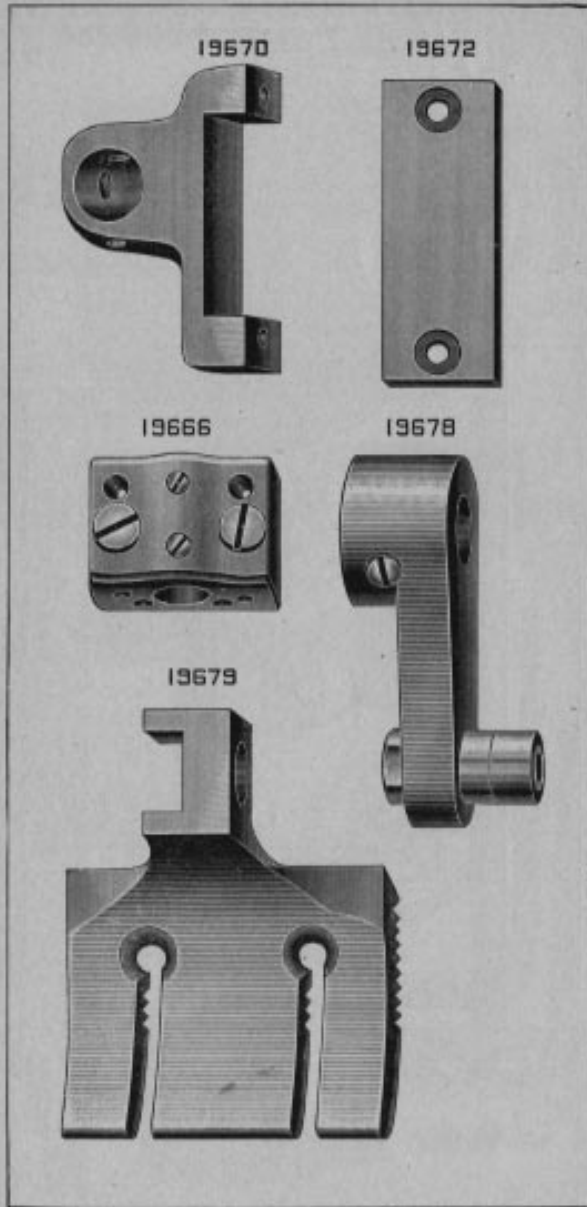

PLATE 913—FULL SIZE

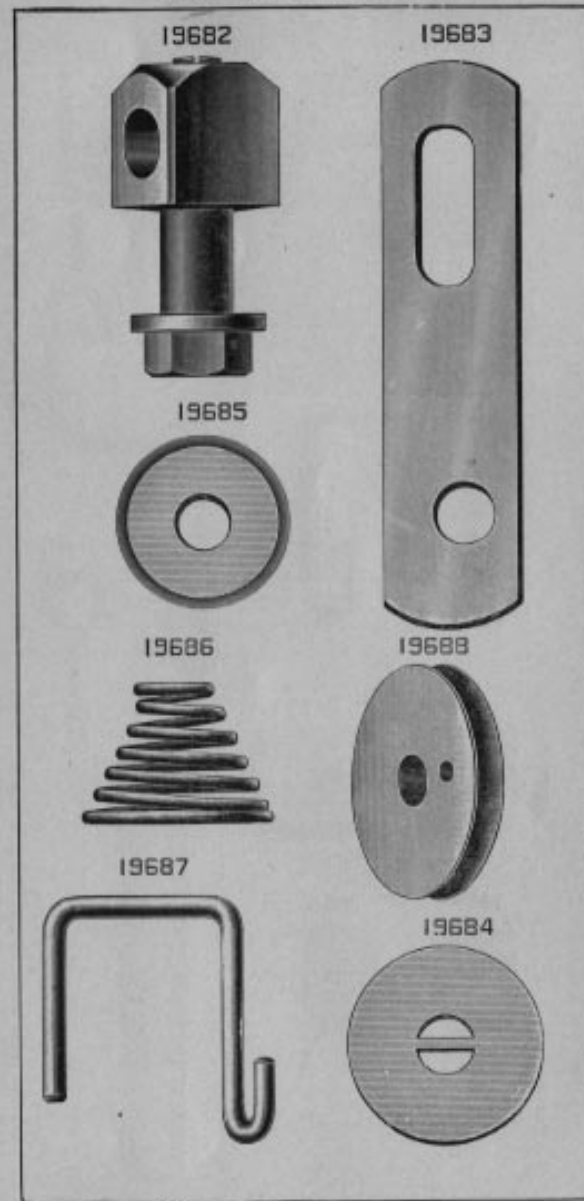

PLATE 914—FULL SIZE

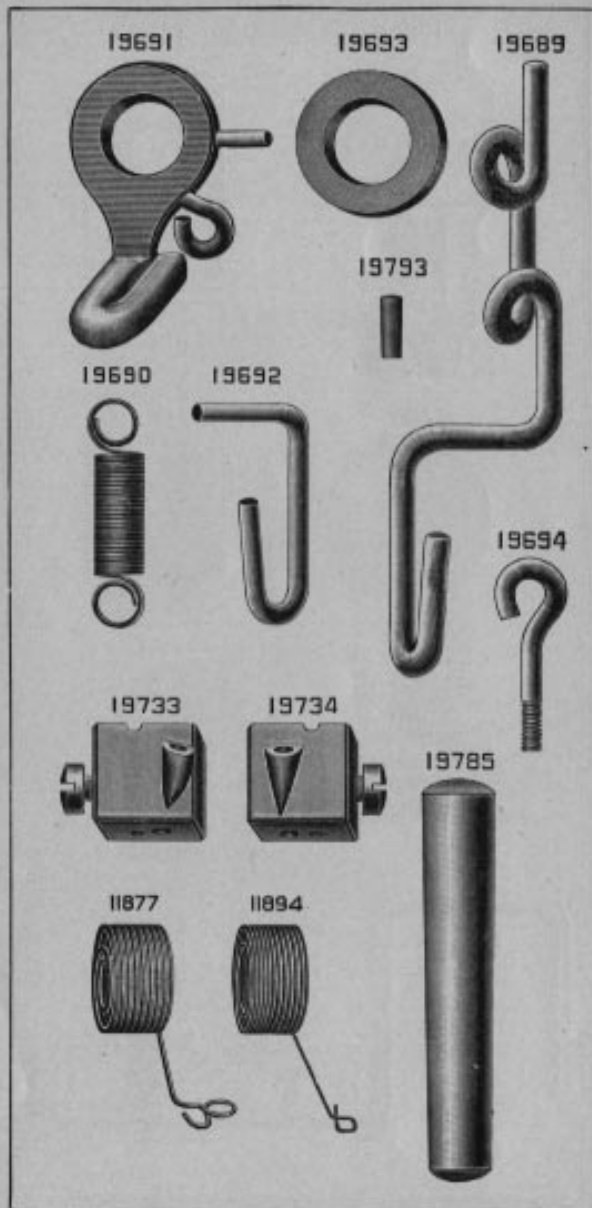
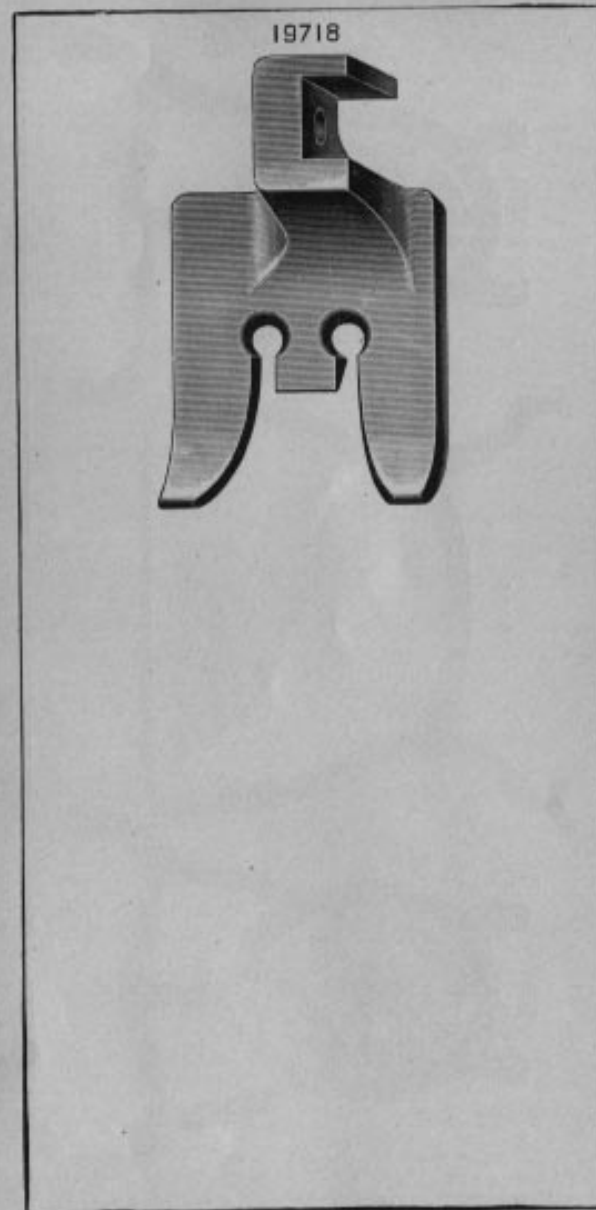

PLATE 920—FULL SIZE



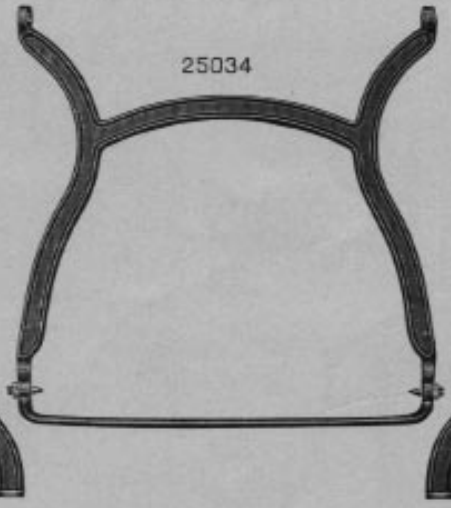
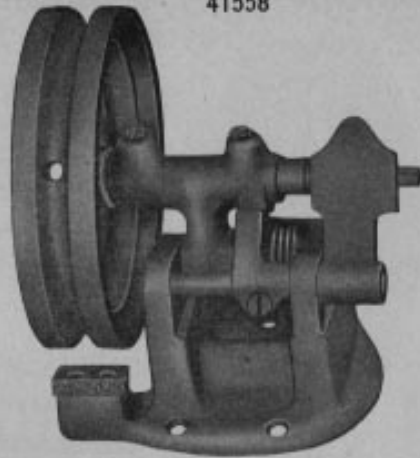

PLATE 1860—ONE-NINTH SIZE

PLATE 3579—ONE-HALF SIZE

41558



41439

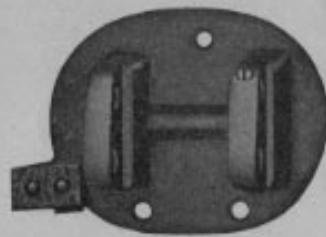

41557



41444



41446



PLATE 3581—ONE-HALF SIZE

41443



41447



41442



41441



41440



PLATE 3582—ONE-FOURTH SIZE

41454



60608

27560

41514



27555

41450

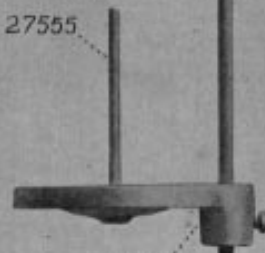

27557



**PLATE 3583—FULL SIZE**

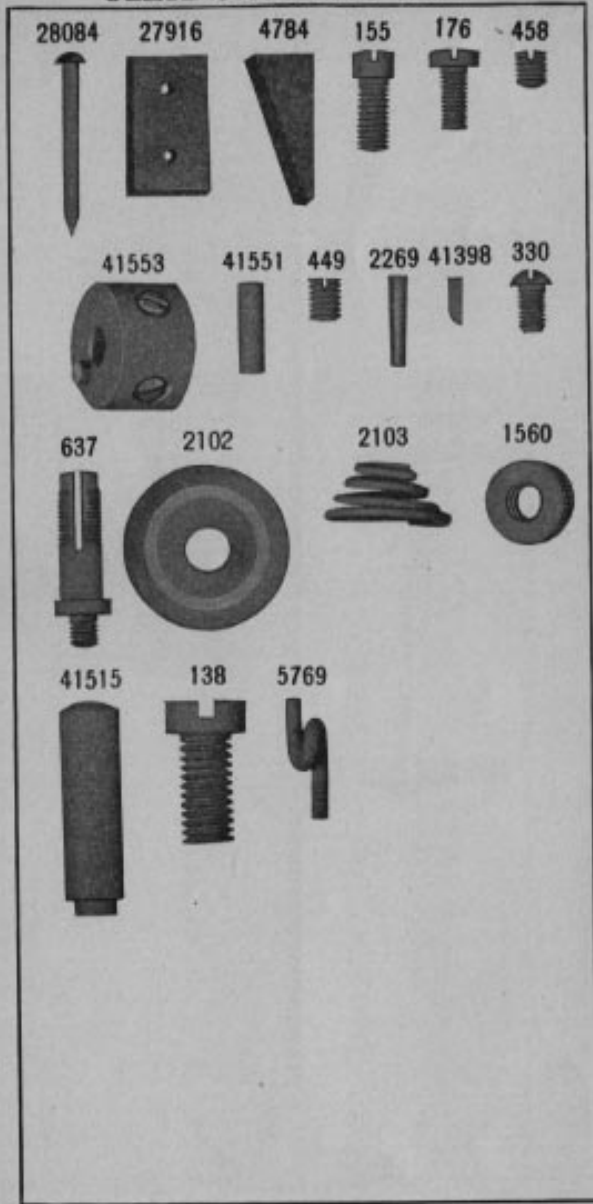

**PLATE 4403—ONE-HALF SIZE**

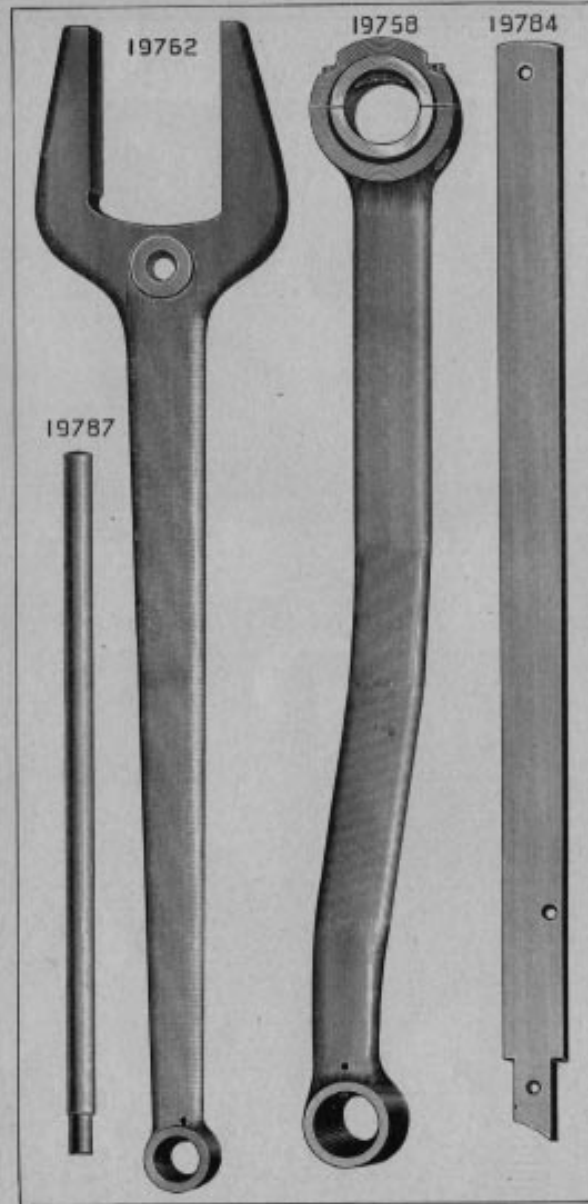

PLATE 4406—FULL SIZE

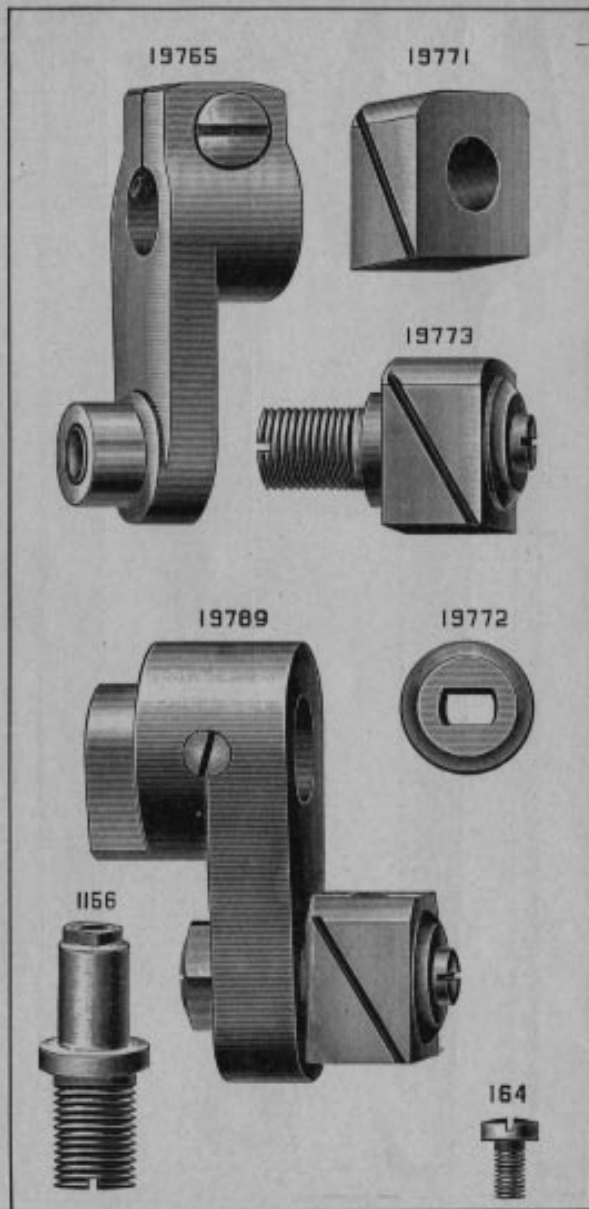

PLATE 4407—ONE-HALF SIZE

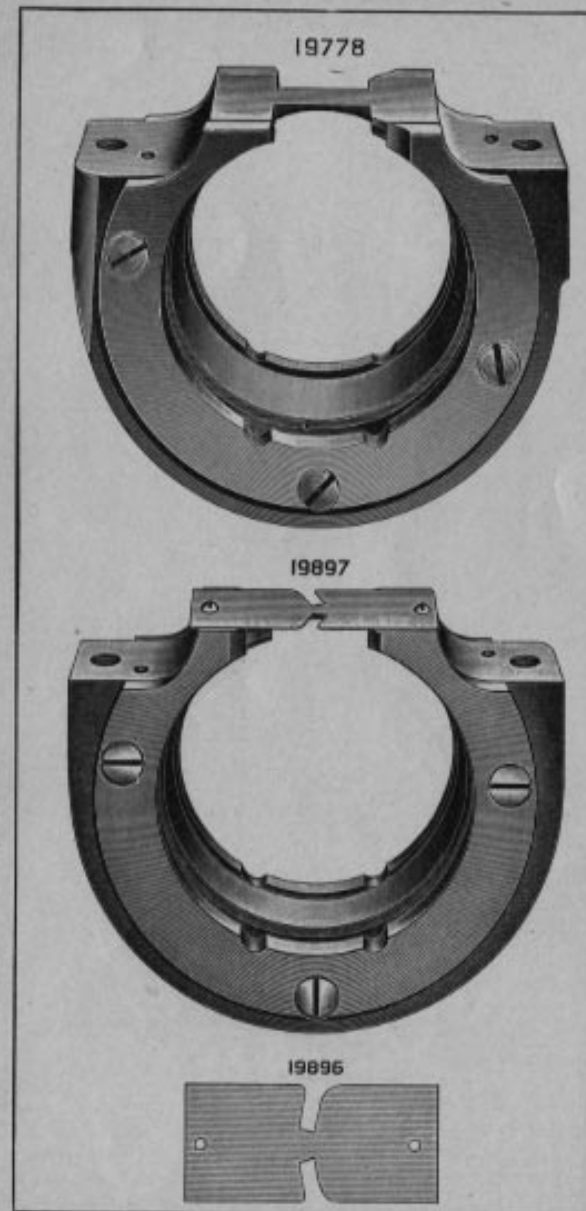

PLATE 4408—ONE-HALF SIZE

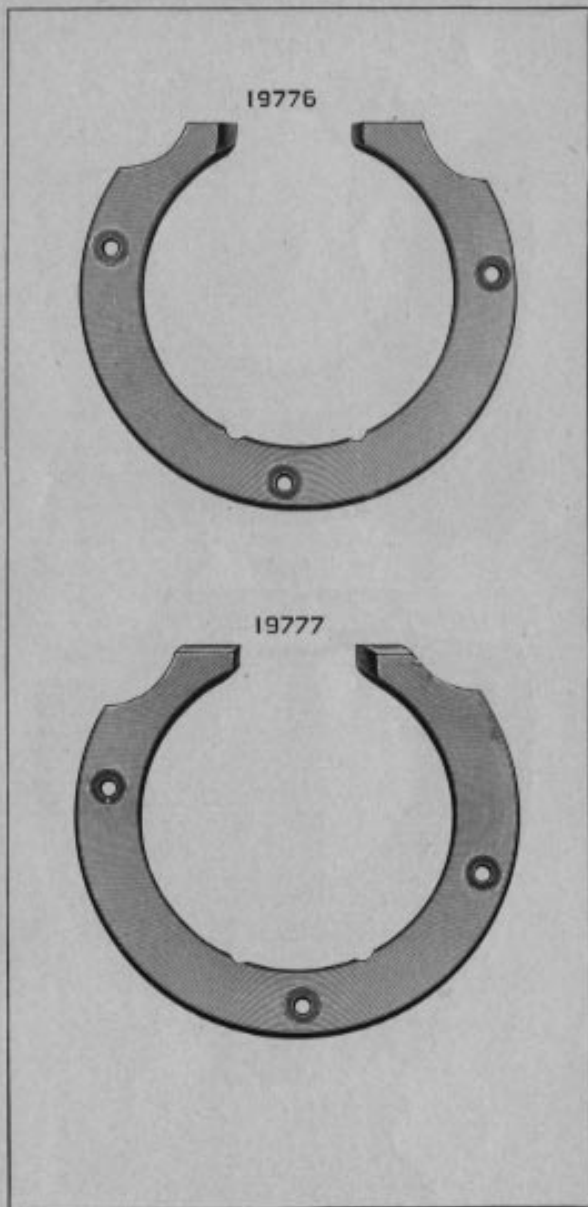

PLATE 4413—FULL SIZE

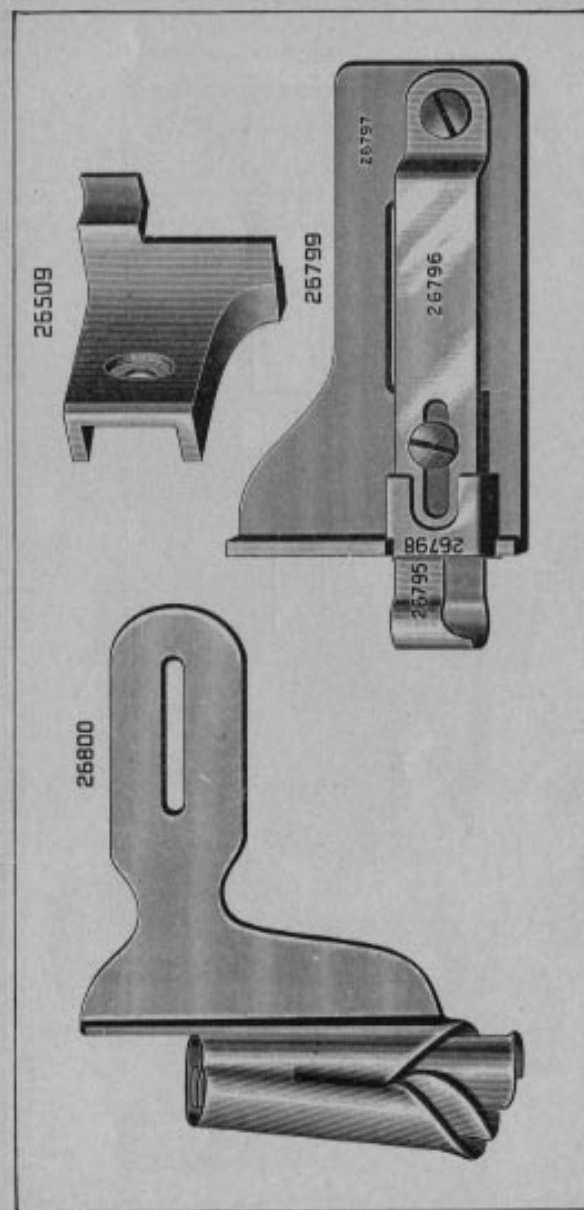



PLATE 4419—FULL SIZE

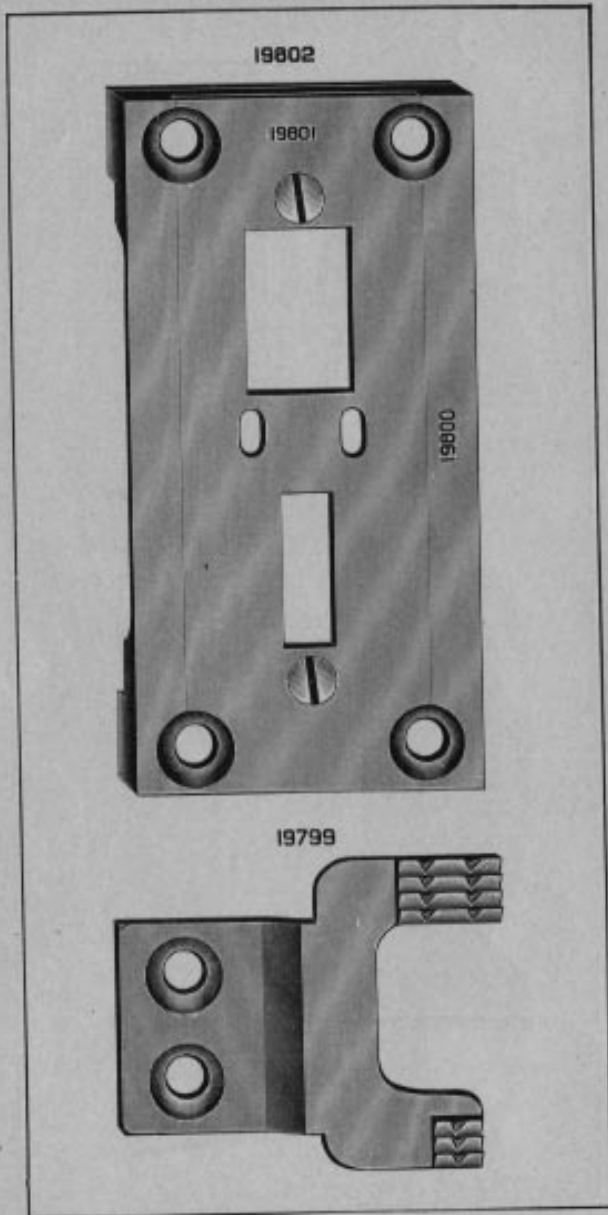

PLATE 4421—FULL SIZE

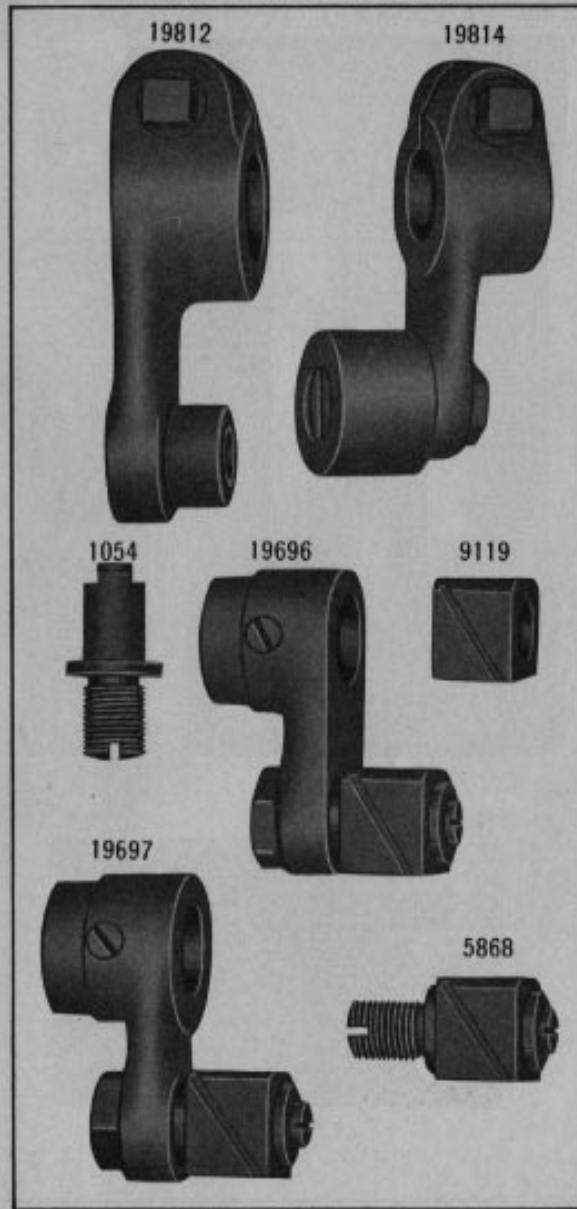

PLATE 4431—FULL SIZE

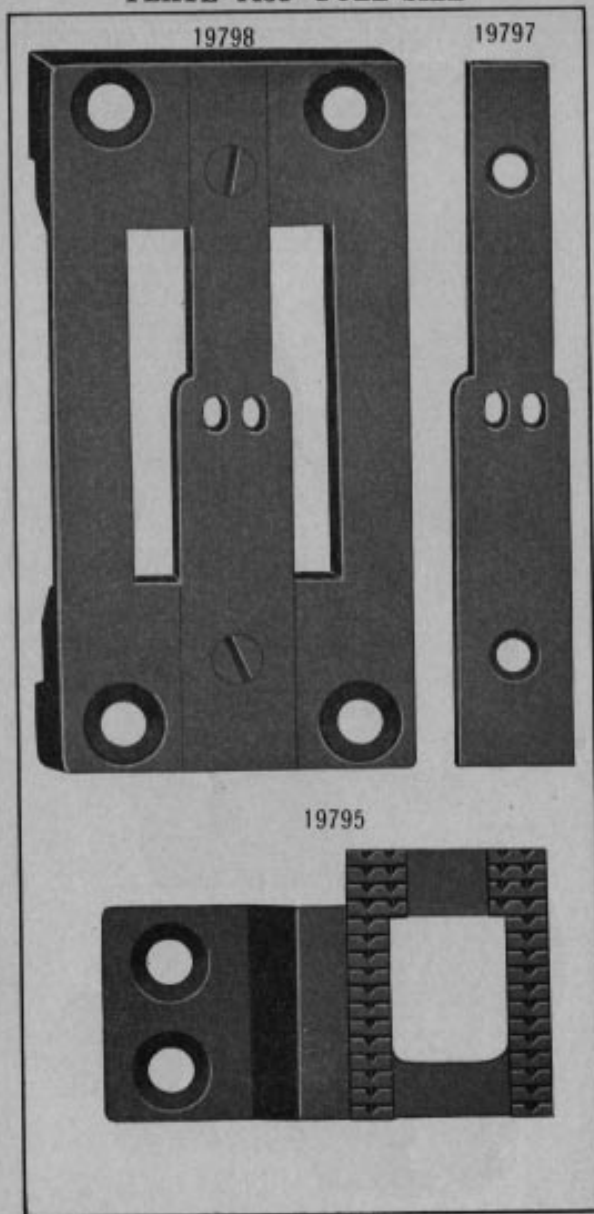

PLATE 4454—FULL SIZE

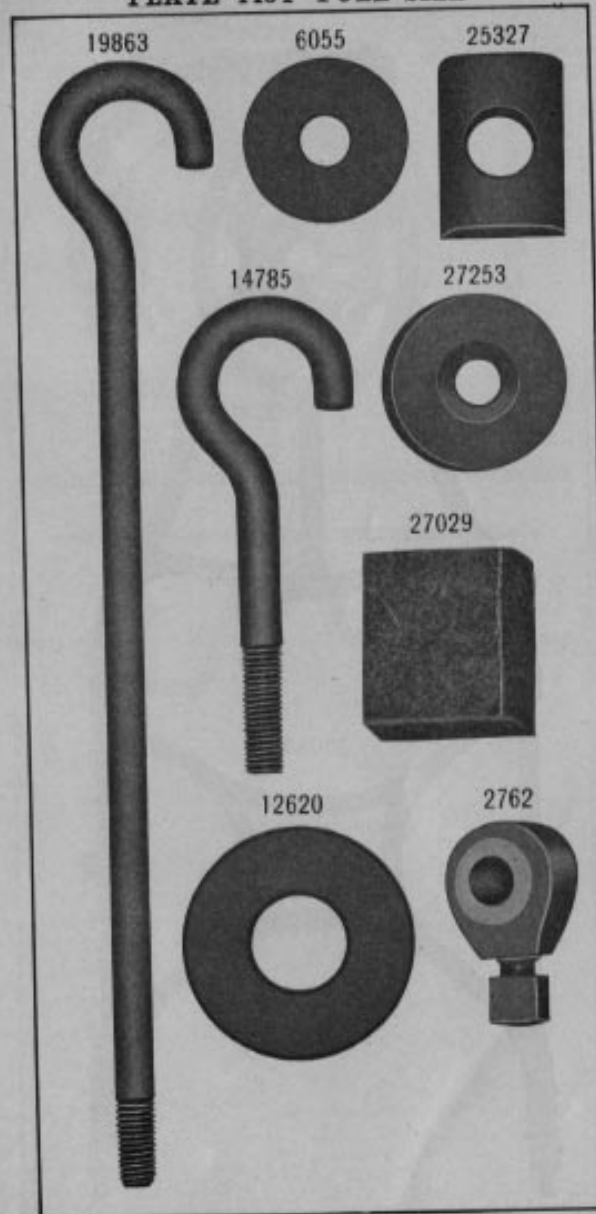

PLATE 4459—ONE-NINTH SIZE

25094



25093

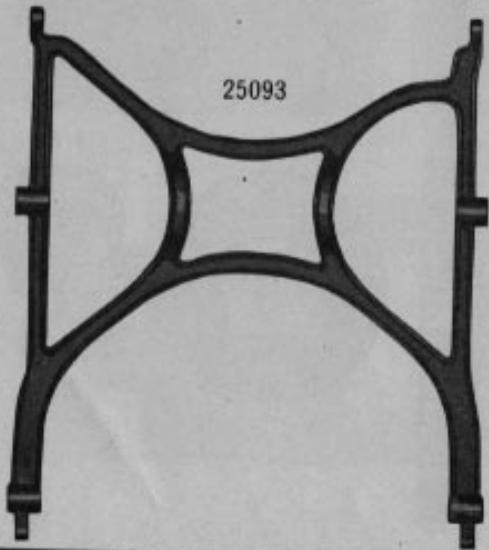

PLATE 4460—ONE-NINTH SIZE

25087

25095



25090



25326



25097



PLATE 4484—ONE-HALF SIZE

23535 120344 8909 26026 11831



PLATE 4486—ONE-HALF SIZE

43271 43270 41899

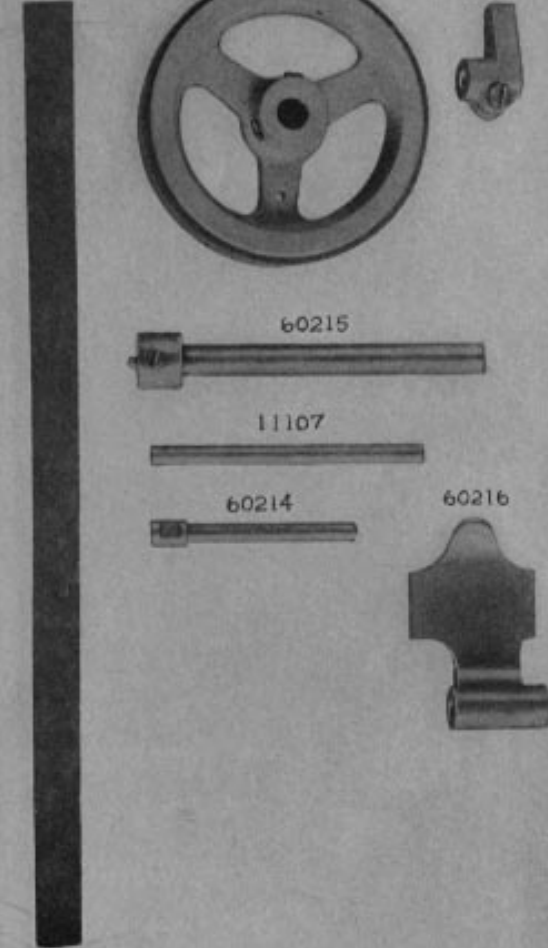

PLATE 4491—FULL SIZE



PLATE 4492—FULL SIZE

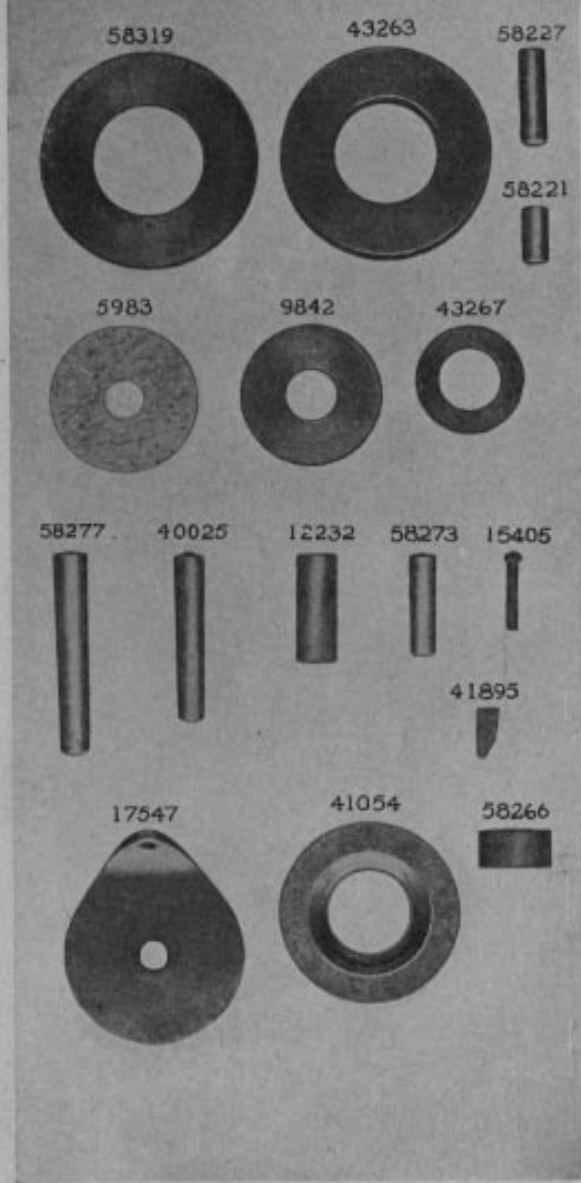

PLATE 4494—FULL SIZE

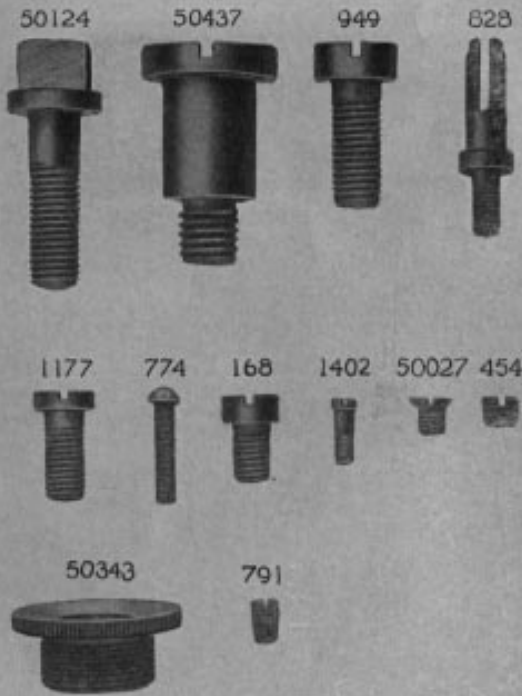

PLATE 4496—ONE-EIGHTH SIZE

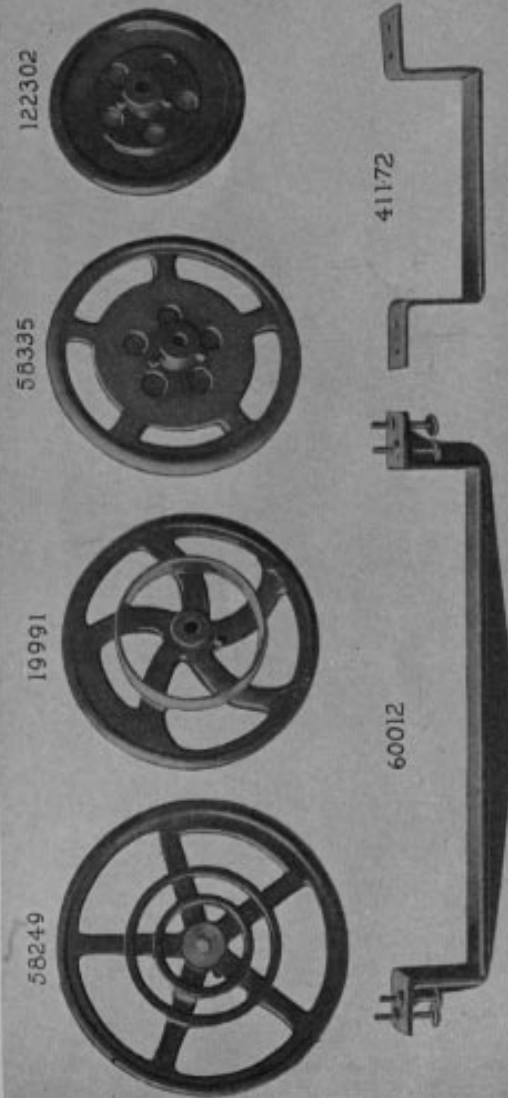

PLATE 4498--FULL SIZE

58328

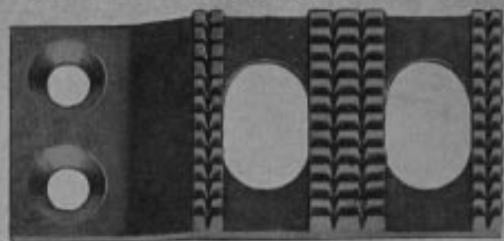
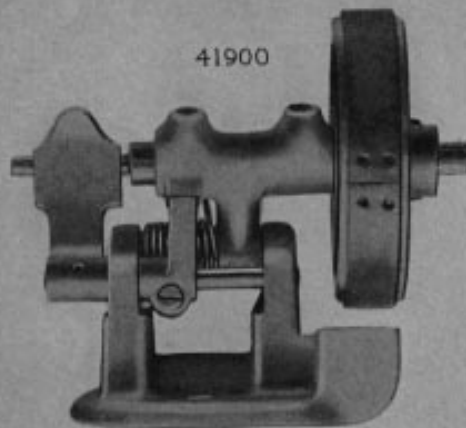
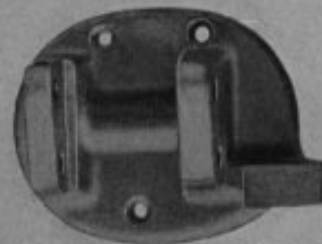

PLATE 6781--ONE-HALF SIZE

41900



41894



41557



41898



41446



PLATE 7285—ONE-FOURTH SIZE

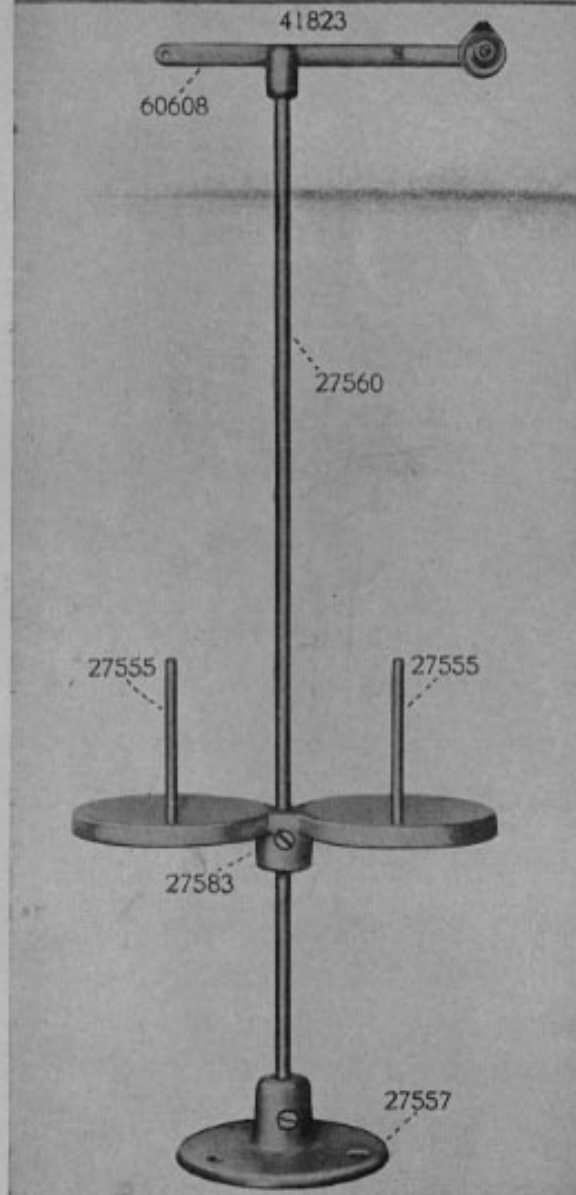

PLATE 7820—FULL SIZE

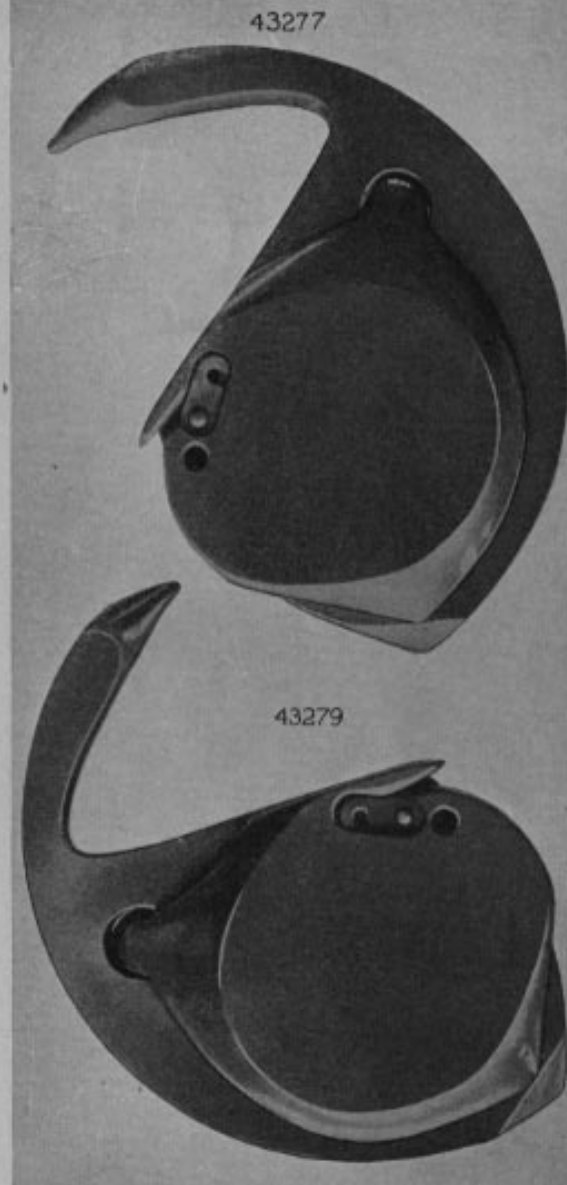
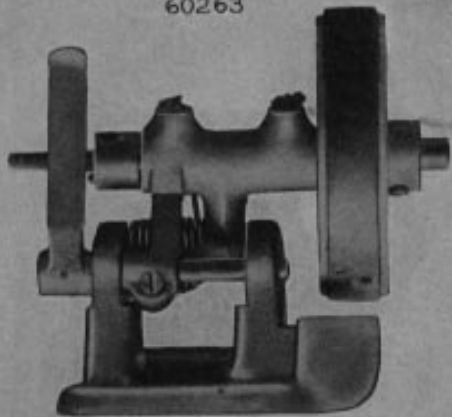



PLATE 7827—ONE-HALF SIZE

60263



60262



60261



PLATE 7847—ONE-FOURTH SIZE

58329



58233



19970



27640



27637

58254



11917

25881



PLATE 7848—ONE-HALF SIZE

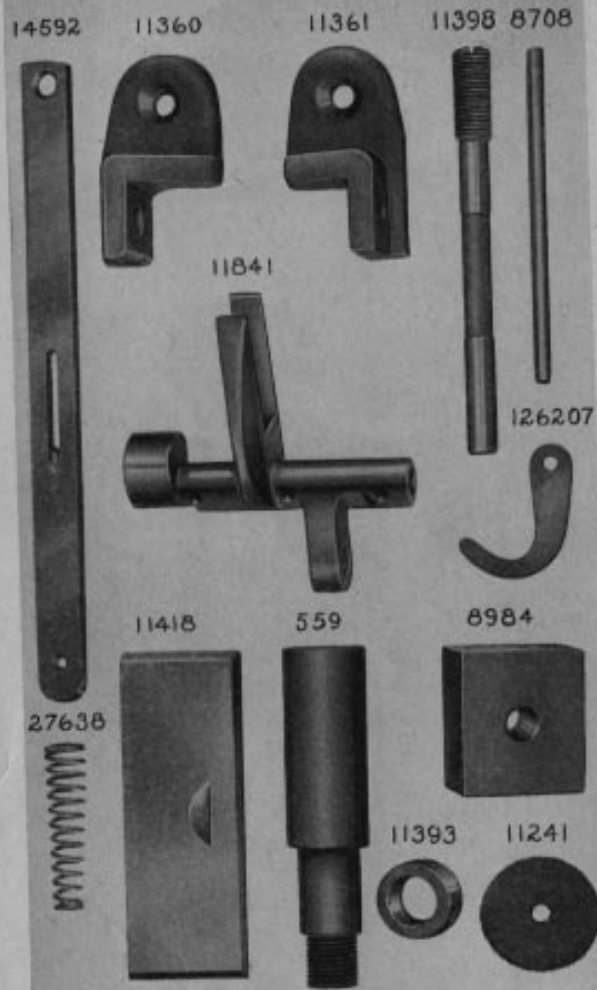

PLATE 7849—ONE-NINTH SIZE

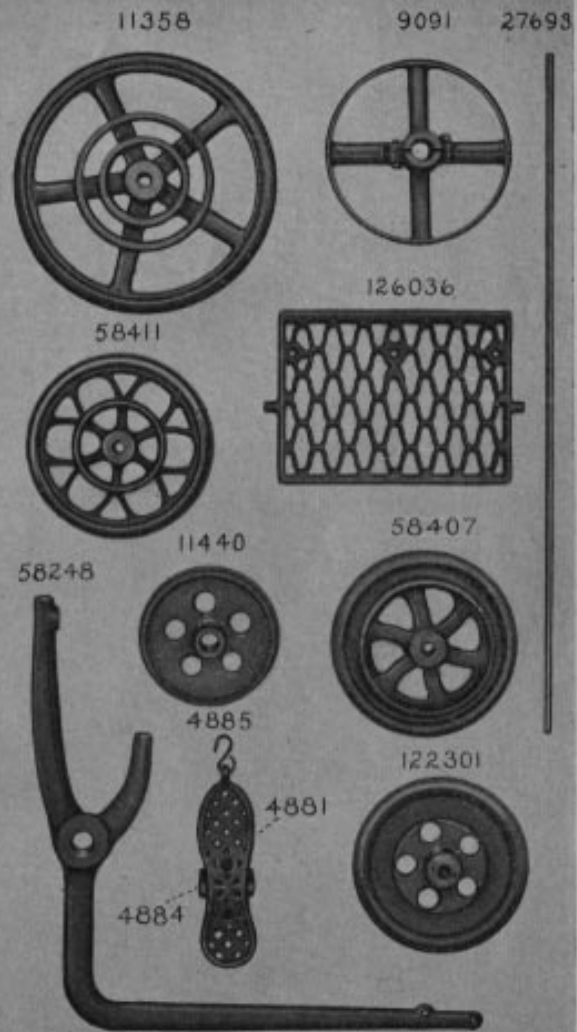

PLATE 7850—FULL SIZE

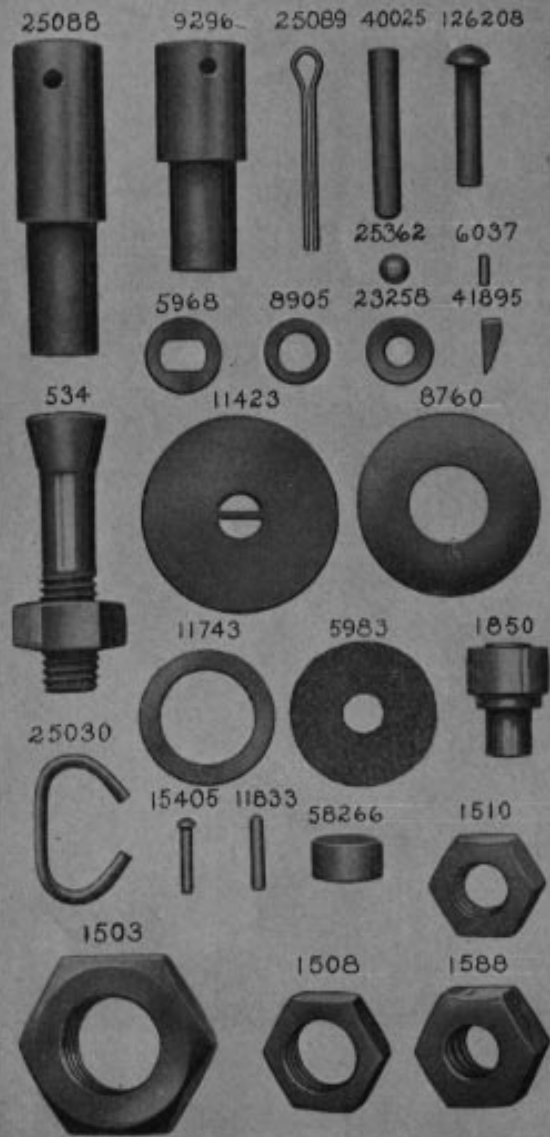

PLATE 7851—ONE-HALF SIZE

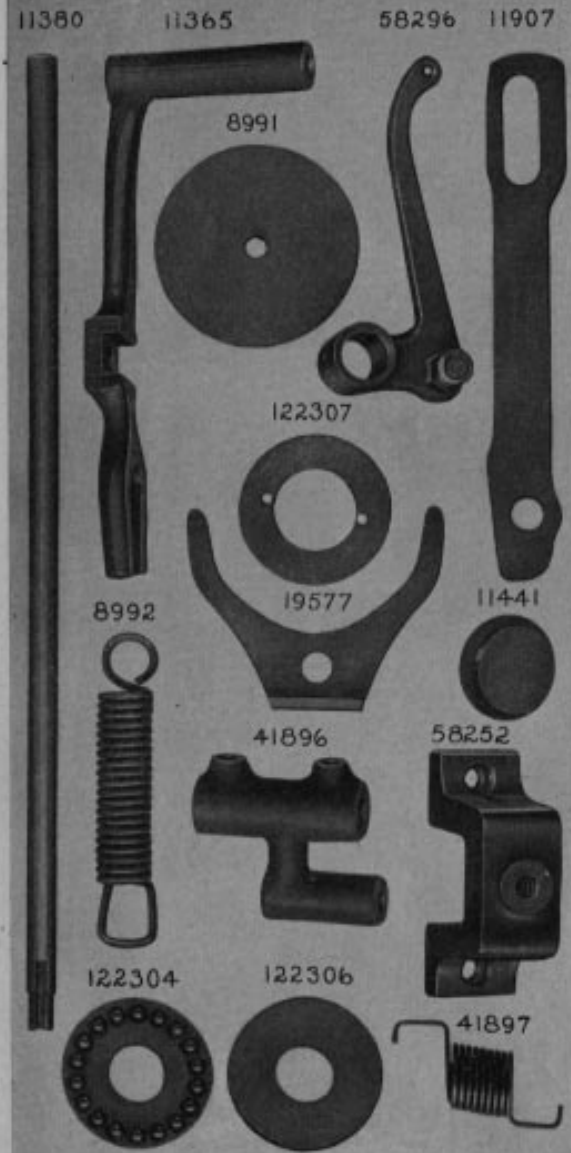

PLATE 7852—ONE-FOURTH SIZE

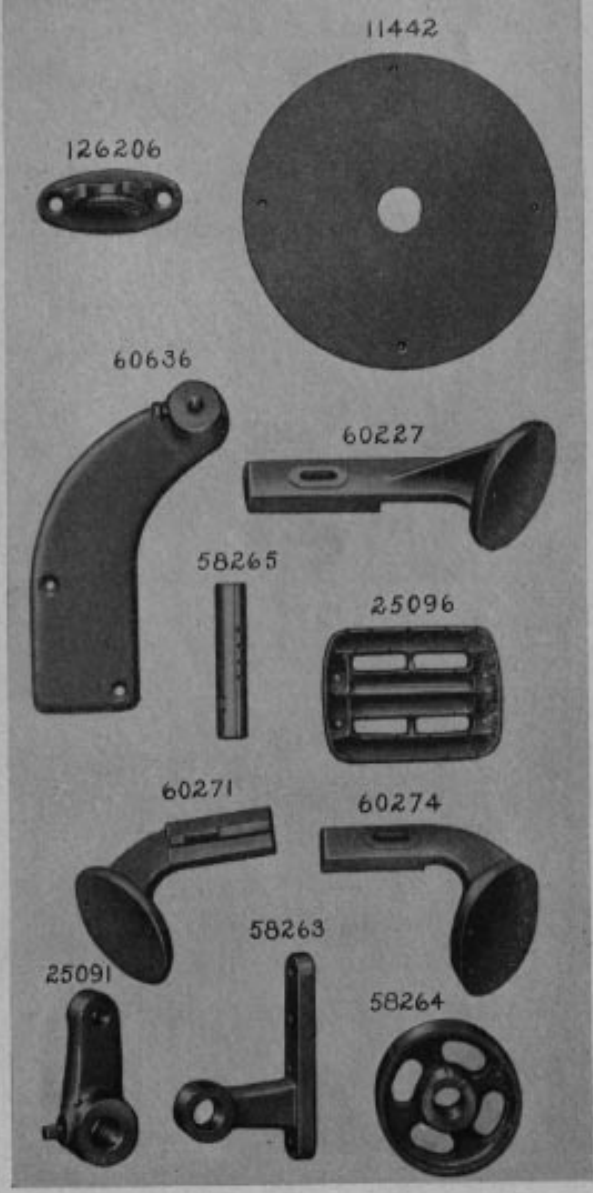

PLATE 7854—FULL SIZE

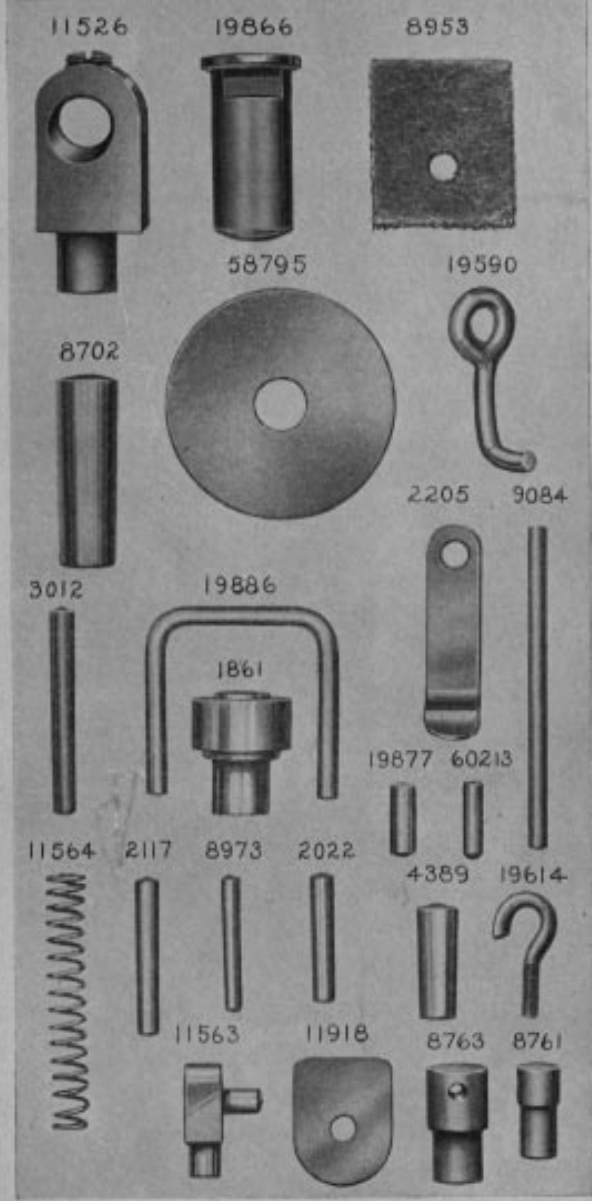

PLATE 7855—FULL SIZE



PLATE 7856—ONE-FOURTH SIZE

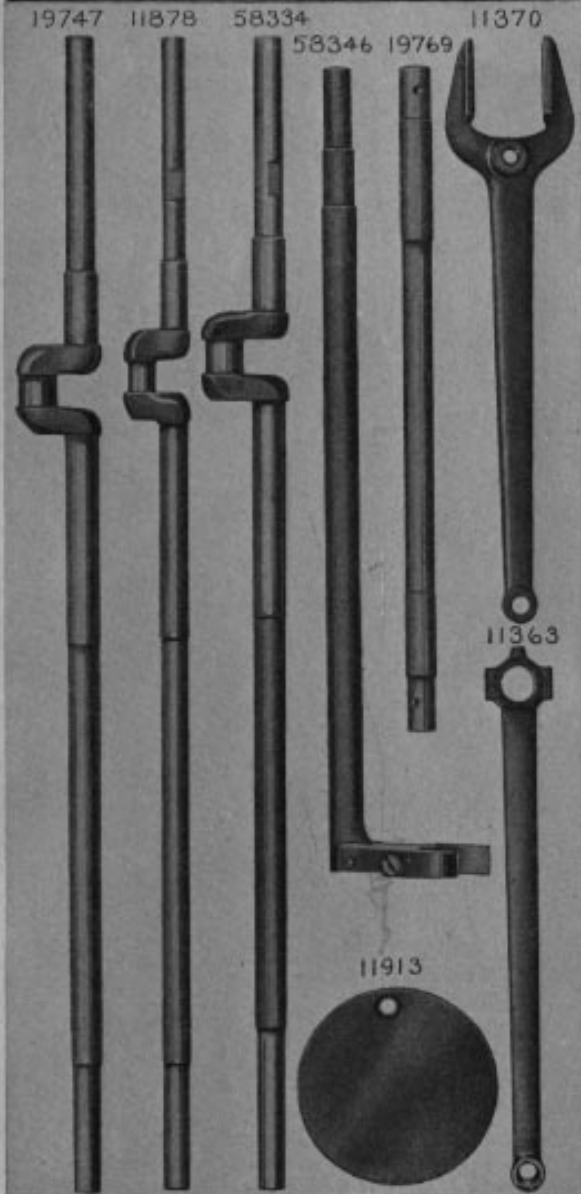

PLATE 7857—ONE-HALF SIZE

11708 19967 11375 11454 19677



19528

19676

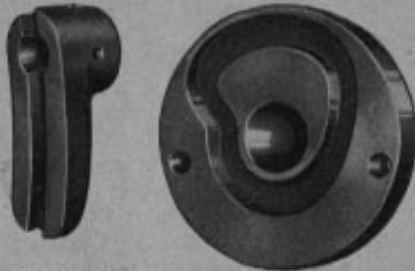

11698 11875

11354

11942

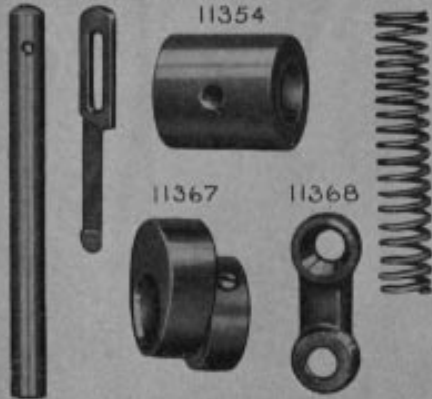

11367

11368



PLATE 7858—ONE-FOURTH SIZE

58218 58311 19567 11031

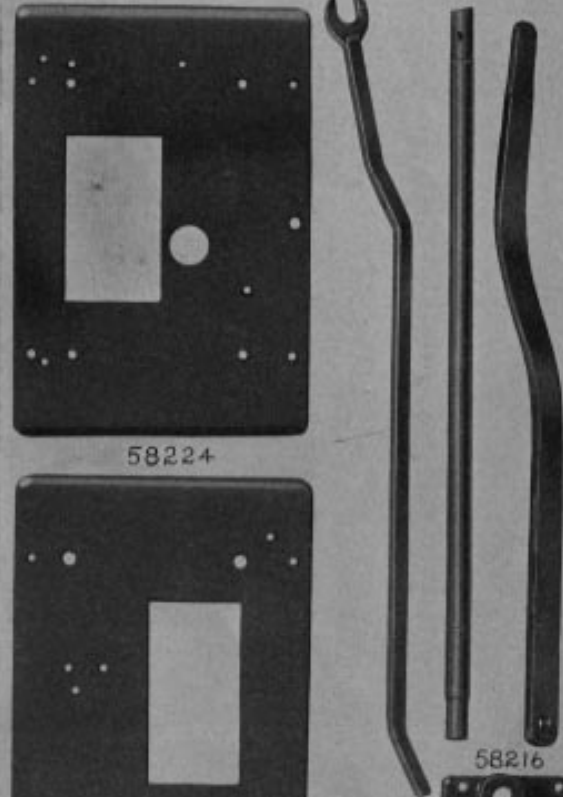

58224

58216

19786

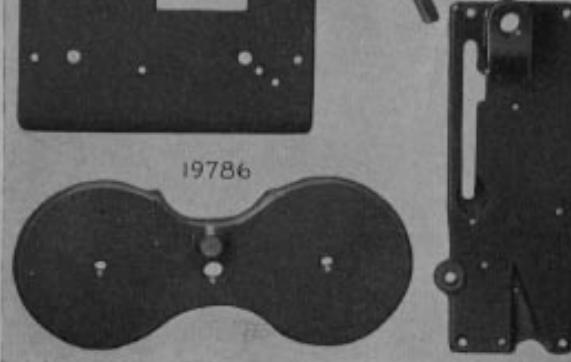

PLATE 7859—FULL SIZE

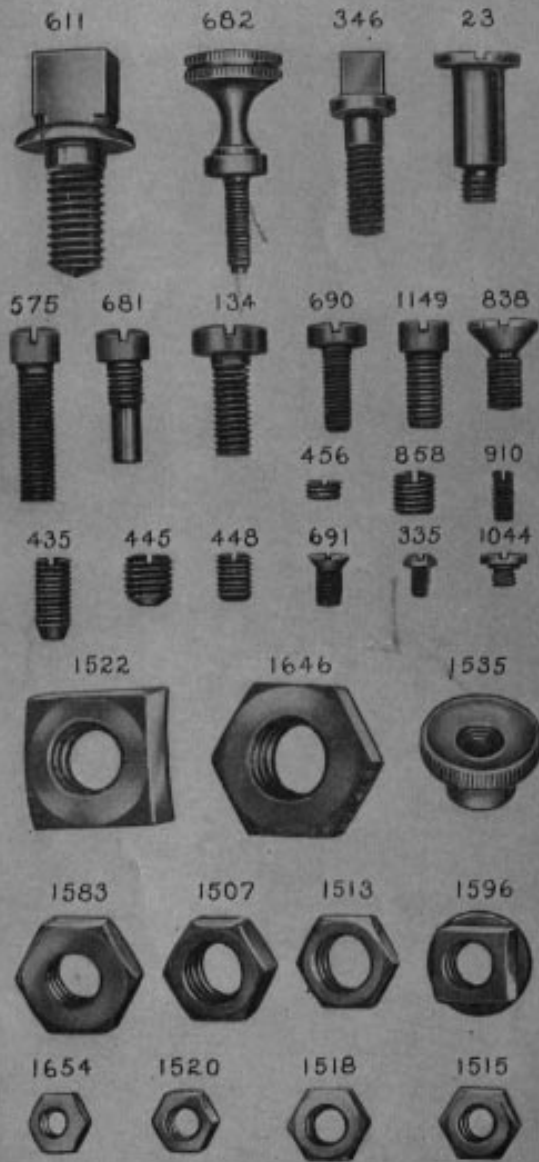

PLATE 7860—ONE-HALF SIZE

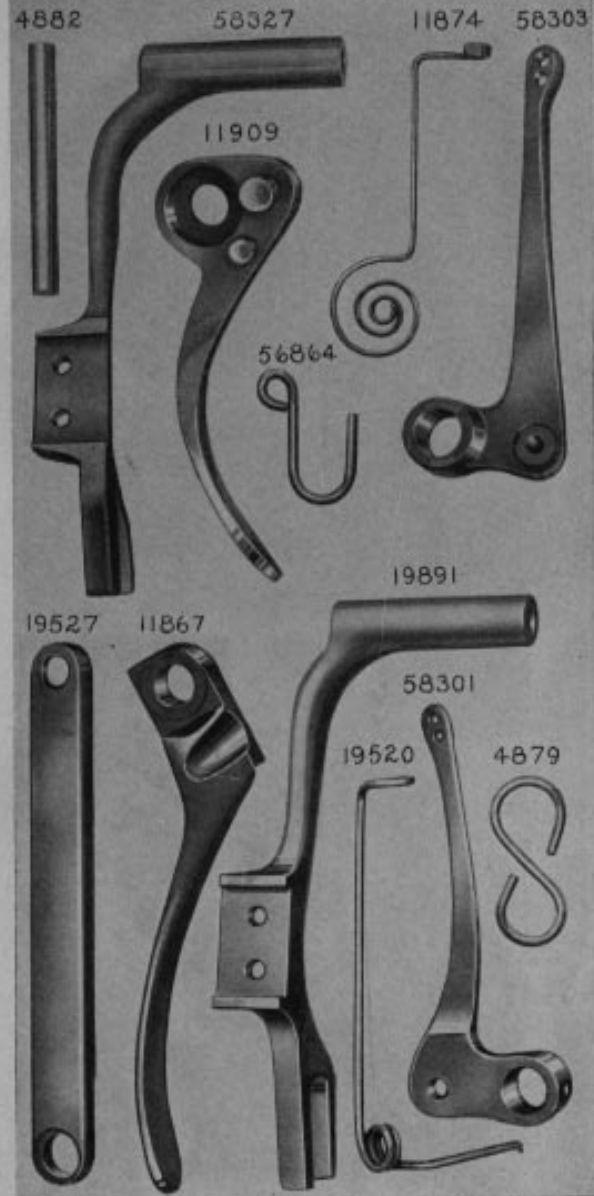

PLATE 7861—FULL SIZE

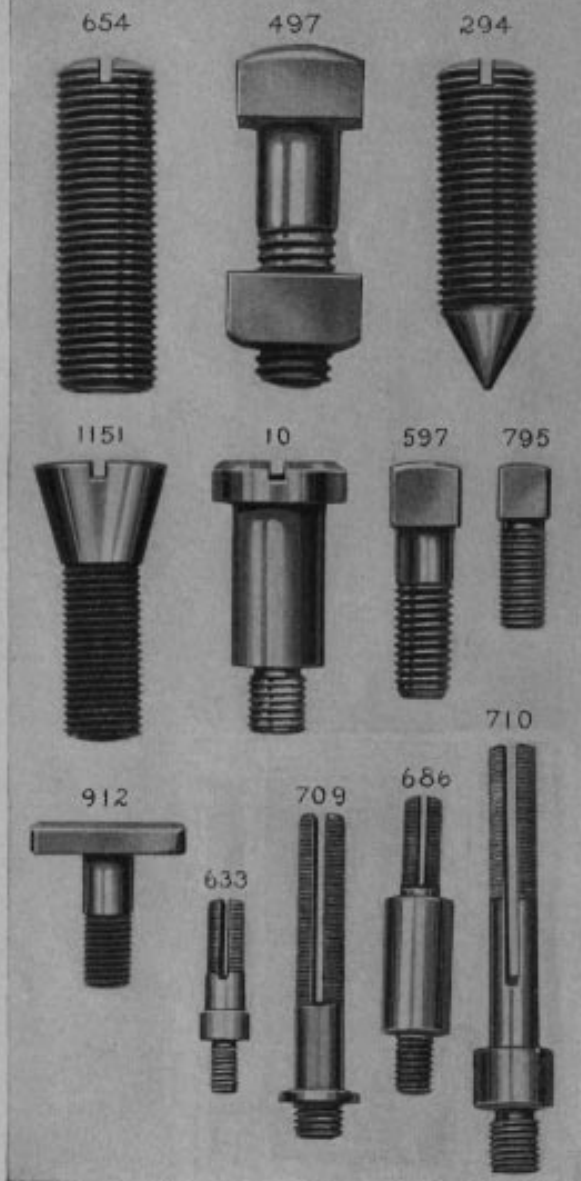

PLATE 7862—FULL SIZE

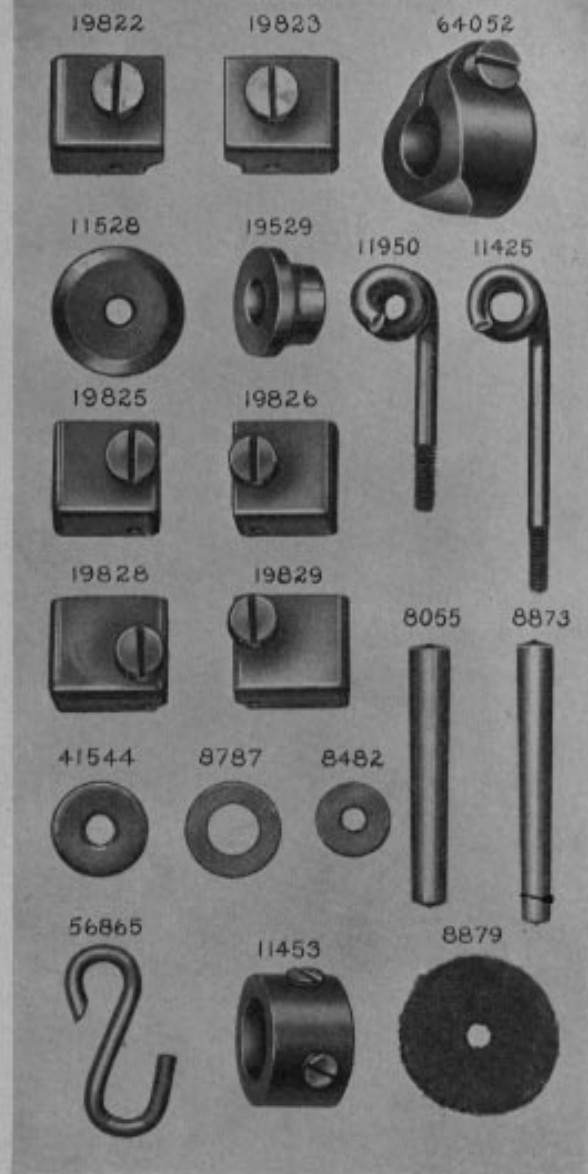



PLATE 7863—ONE-HALF SIZE

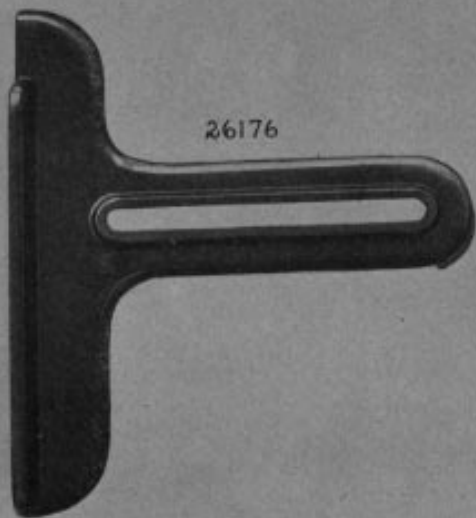
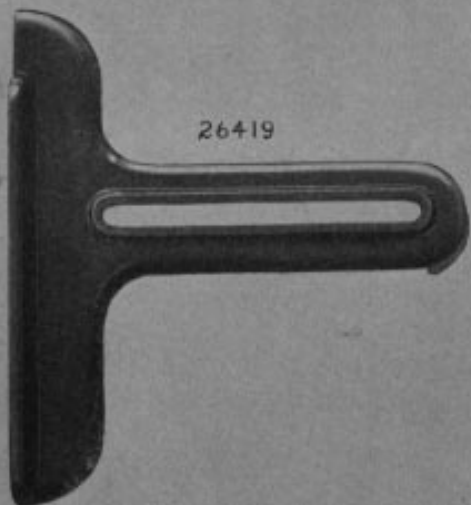
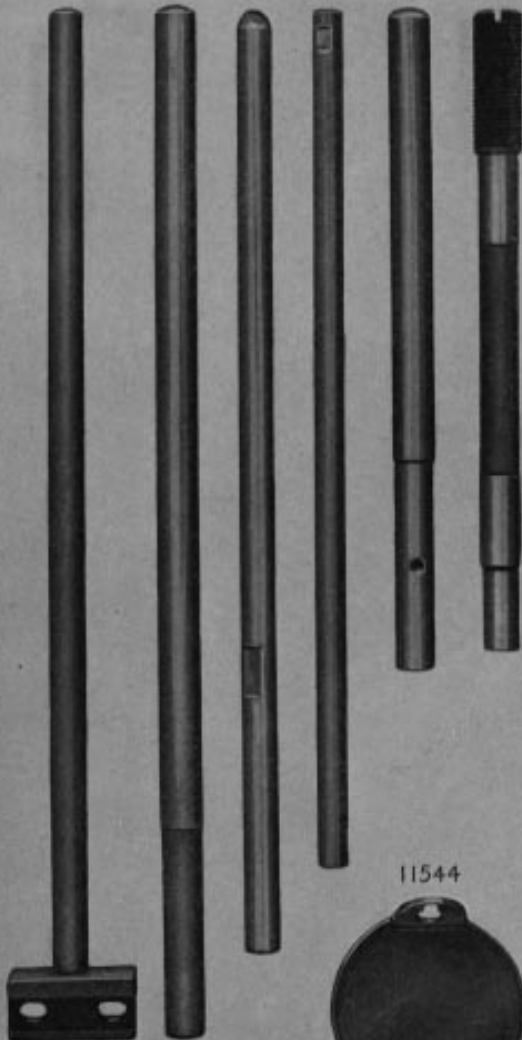

PLATE 7864—ONE-HALF SIZE

19821 11451 19535 58236 11450 9115



11544



PLATE 7865—ONE-HALF SIZE

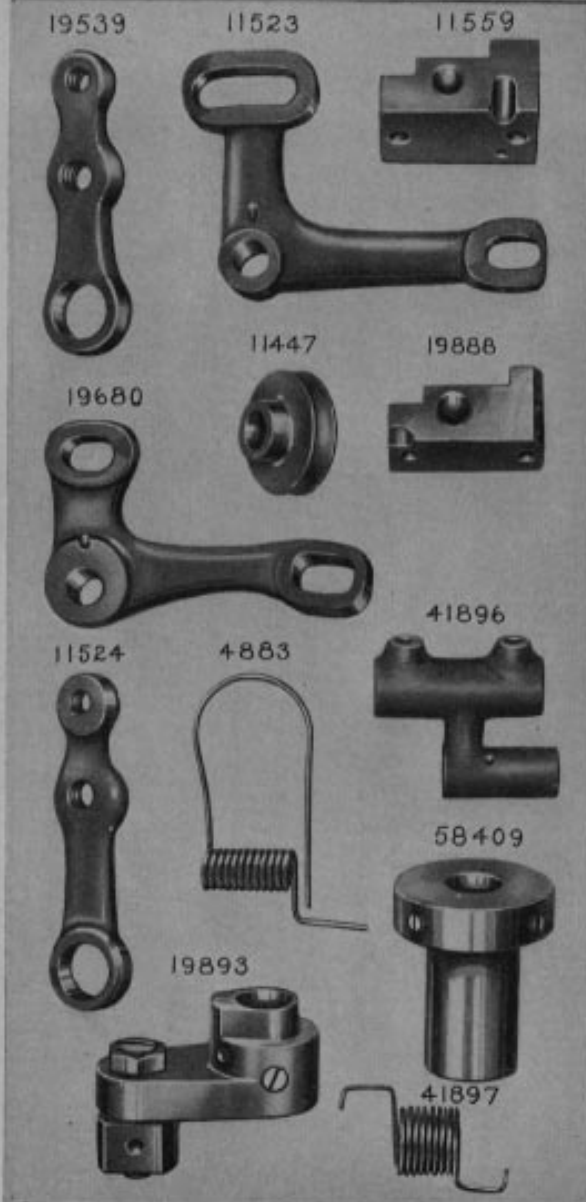

PLATE 7866—FULL SIZE

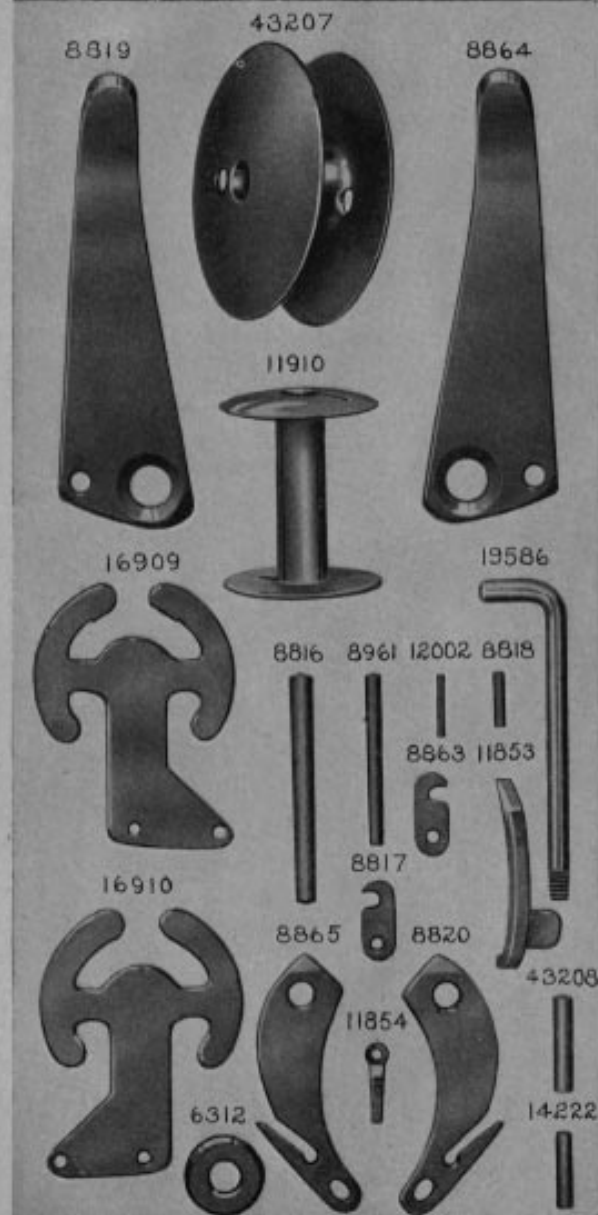
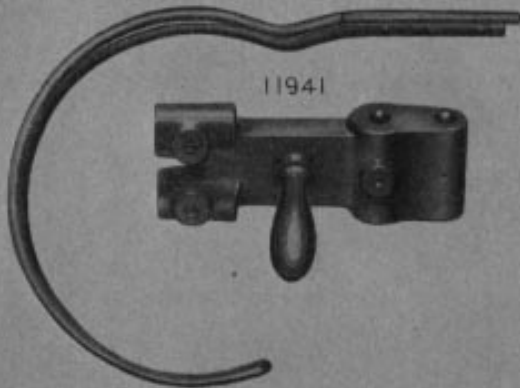

PLATE 7867—ONE-FOURTH SIZE

11940



11941



19894



11428



46681



60218



60264



19768

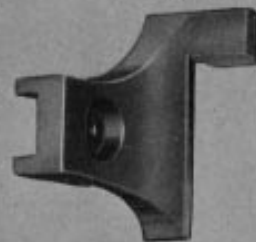

PLATE 7868—FULL SIZE

19715



19717



1995



11446



19595

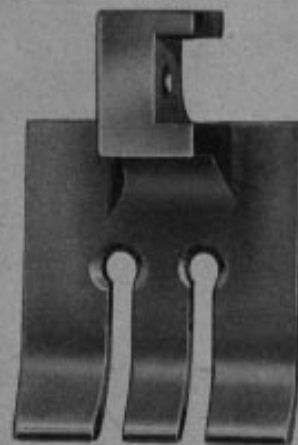
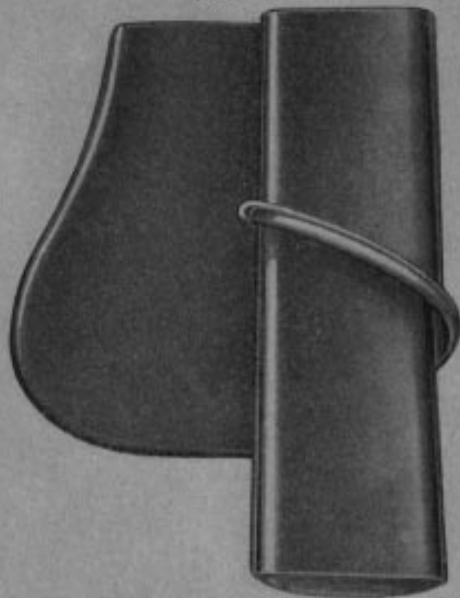

PLATE 7869—ONE-HALF SIZE

120147



26789



120182

