

Singer 78-2

Singer 78-3

Form 18942
October, 1935
Printed in U. S. A.

LIST OF PARTS



SINGER** MACHINES Nos. 78-2 and 78-3

THE SINGER MANUFACTURING COMPANY

**A Trade Mark of THE SINGER MANUFACTURING COMPANY

INSTRUCTIONS FOR OILING

To ensure easy running and prevent unnecessary wear of the parts which are in movable contact, the machine requires oiling and when in continuous use, "TYPE B" or "TYPE D" OIL, sold by Singer Sewing Machine Company, should be applied at least twice each day to all oil holes marked "OIL", as instructed in Form 8348.

"TYPE D" OIL should be used when an oil is desired which will produce a minimum of stain on fabrics, even after a long period of storage.

Copyright, U. S. A., 1921, 1923 and 1935
by The Singer Manufacturing Company
All Rights Reserved for All Countries

INDEX

	Page
Attachments and Accessories.....	12
Binders.....	12
Bobbin Winders.....	18
Foot Lifter Parts.....	20
Hammers.....	21
Knee Lifter Parts.....	21
Machine No. 78-2.....	5
Machine No. 78-3.....	11
Numerical List of Parts.....	23

INSTRUCTIONS FOR ORDERING

In ordering from this list, use ONLY the part NUMBER in the FIRST column.

The number stamped on a Sewing Machine Part is in every case the number of the single part only.

Every combination of parts sent out as such has its specific number, which, although not stamped on the parts, must be used when ordering the combination.

Each number always indicates the SAME PART in whatever list it appears, or for whatever machine.

The letters after some of the numbers indicate the style of finish only, as follows:

A-Hardened, Polished, Nickel Plated and Buffed

B-Polished, Nickel Plated and Buffed

C-Hardened Only

D-Polished Only

E-Soft, Not Polished

F-Hardened and Polished

G-Bright Rumbled and Nickel Plated

H-Blued

J-Nickel Plated Only

K-Hardened and Nickel Plated

L-Brass Plated

M-Oxidized

N-Japanned, Dull

P-Japanned, Bright

R-Merlized

T-Copper Plated

T.A-Hardened, Polished, Copper and Nickel Plated and Buffed

T.B-Copper and Nickel Plated and Polished

T.J-Copper and Nickel Plated Only

T.K-Hardened, Copper and Nickel Plated

T.M-Copper Plated and Oxidized

T.L-Copper and Brass Plated

U-Zinc Plated

V-Silver Plated

W-Polished and Nickel Plated

Y-Black Nickel Plated Only

Z-Chromium Plated

Z.B-Polished, Nickel Plated, Buffed and Chromium Plated

Z.J-Nickel and Chromium Plated

These letters MUST BE USED when they appear in the list; and AFTER the number as in the list.

In this series:

1 to 1500, 50001 to 51500 and 140001 to 142000 are Screw Numbers

1501 to 1800 and 51501 to 51600 are Nut Numbers

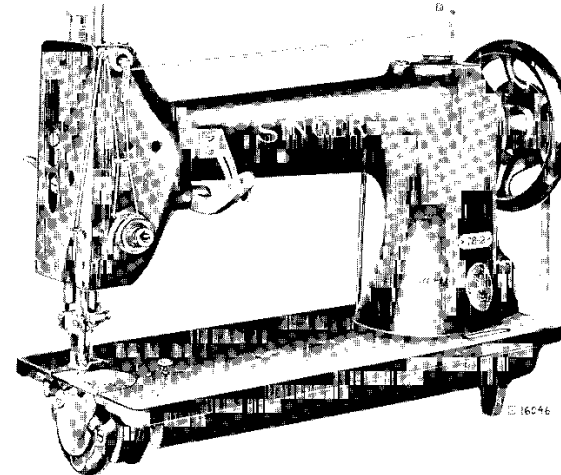
1801 to 2000 and 51801 to 52000 are Roller Numbers

2001 to 50000 and 52001 to 140000 and 142000 to 190000 are Sewing Machine Parts, 190001 and upward are numbers of Electrical Parts.

The figures in the second column refer only to the plates, illustrating the parts, and are NOT TO BE USED in ordering.

Parts marked with an asterisk (*) are furnished only when repairs are made at factory.

**LIST OF PARTS COMPLETE
FOR**



MACHINE NO. 78-2

FOR CLOSING FILLED MATTRESSES. ALSO FOR BINDING FILLED MATTRESSES AFTER THEY HAVE BEEN CLOSED. THE END OF THE MACHINE BED IS FLUSH WITH THE SHUTTLE RACE SO THAT THE MATTRESS CAN BE BROUGHT CLOSE TO THE NEEDLE. COMBINED UPPER AND NEEDLE FEED. NO UNDER FEED.

No.	Plate	Name
*37363	----	Arm with 15404 and two 15405.....
8582	6143	" Dowel Pin.....
11119	6143	" Oil Tube with 52045, for oiling 37343.
12454	6143	" " " " 52045, for oiling 37344.
52045	6143	" " " Packing (wick).....
748E	6143	" Screw (back).....
854E	6143	" " (front).....
37377	6154	" Shaft.....
12357	6144	" " Flanged Bushing (back).....
448C	6143	" " " " Set Screw.
37303	6144	" " " " (front).....
430C	6143	" " " " Set Screw.
144D	6143	" " Screw.....
29505	6144	" Top Cover.....
29506	6144	Arm Top Cover complete, Nos. 29505, 29507 and 29601.....

PARTS FOR MACHINE 78-2

No.	Plate	Name
4303	6147	Needle Clamp with 808F.....
808F	6145	" " Screw.....
37423	6147	" " Plate (large needle hole) for 37381
37381	6147	" " " " " " 37423
		with 37384 and two 1161D.....
37424	6147	Needle Plate (medium needle hole) for 37382.....
37382	6147	Needle Plate (medium needle hole) 37424 with 37384 and two 1161D.....
37384	6147	Needle Plate Thread Guard.....
1161D	6147	" " " " Screw.....
891F	6145	" " " " Screw.....
44222	6146	Oil Cup.....
44223	6146	" " 44222 with 44005.....
44214	----	" " Extension.....
44005	6146	" " " 44214 with 24075.....
24075	6146	" " " Post.....
44006	6146	" " Packing (felt).....
44224	6146	" " Thread Retainer.....
44225	6146	Oil Cup complete, Nos. 44006, 44223 and 44224.....
24104	6153	Oscillating Rock Shaft.....
24105	----	Oscillating Rock Shaft complete, Nos. 4784, 12388 and 24104.....
12388	6146	Oscillating Rock Shaft Hinge Pin.....
878J	6149	" " " " " Oil Hole Stop Screw.....
12459	6149	Oscillating Rock Shaft Hinge Pin Oil Hole Stop Screw Washer (leather).....
448C	6143	Oscillating Rock Shaft Hinge Pin Set Screw
4784	6146	" " " Oil Pad.....
12389	6146	" " Shaft.....
37385	----	" " Crank.....
37386	6148	Oscillating Shaft Crank complete, Nos. 457C, 1518E, 19449 and 37385.....
2049	6145	Oscillating Shaft Crank Pin.....
457C	6149	" " " Set Screw.....
19448	6148	" " " Slide Block.....
226J	6148	" " " " " Cap Screw.....
12424	6148	Oscillating Shaft Crank Slide Block Cap Screw Washer.....
988C	6148	Oscillating Shaft Crank Slide Block Screw Stud.....
1518J	6148	Oscillating Shaft Crank Slide Block Screw Stud Nut.....
19449	----	Oscillating Shaft Crank Slide Block complete, Nos. 226J, 988C, 12424 and 19448..

PARTS FOR MACHINE 78-2

No.	Plate	Name
1210E	6149	Pressure Regulating Thumb Screw.....
299E	6148	Shuttle Bobbin.....
224840	----	" " " Case with 2523 and 7553....
15140	6148	" " " " Latch.....
2973	6148	" " " " Lever.....
2974	6148	" " " " " Fulcrum Pin.....
2975	6148	Shuttle Bobbin Case Latch Spring.....
592E	6148	" " " " Stop Screw.....
15141	----	" " " " Hinge, Nos. 2973, 2974 and 15140.....
7553	6148	Shuttle Bobbin Case Position Finger.....
2523	6148	" " " " " Rivet..
37411	6153	" " " " " Plate.....
391J	6148	" " " " " Screw..
224841	6148	Shuttle Bobbin Case complete, Nos. 591F, 592E, 2975, 15141, 224840 and 224842.....
37854	6148	Shuttle Body.....
591F	6148	" Tension Regulating Screw.....
224842	6148	" " Spring.....
37855	6148	Shuttle, 1 11/16 in. diam., Nos. 299E, 37854 and 224841.....
*37371	----	Shuttle Driver.....
37372	6148	" " " 37371 with two 462C.....
2049	6145	" " " Pin.....
462C	6149	" " " Set Screw.....
2531	6109	" Race Back.....
2532	6109	" " " Position Pin.....
2533	6109	" " " Spring.....
648D	6109	" " " Screw.....
37360	----	" " Body.....
37405	6153	" " " 37360 with 37361 and two 1053D.....
37361	6109	Shuttle Race Cap.....
1053D	6109	" " " Screw.....
37413	6153	" " Cover.....
1160D	6149	" " " Screw.....
37412	6153	Shuttle Race complete, Nos. 648D, 2531, 2533, 37405, 37411 and two each 391J and 2532.
145E	6109	Shuttle Race Screw.....
2102	6149	Tension Disc.....
1560C	6149	" Regulating Thumb Nut.....
32572	6149	" Releasing Disc.....
37375	6153	" " Lever.....
37387	6153	" " " Connection.....
37388	6153	" " " " Extension
190J	6145	" " " " " Screw.....

No.	Plate	Name
7071	6149	Tension Releasing Lever Connection Extension Screw Washer.....
8285	6149	Tension Releasing Lever Hinge Pin.....
24143	6149	" " " Spring.....
32574	6149	" " " Pin.....
1274C	6149	" Screw Stud.....
2103	6149	" Spring.....
12149	6149	" Thread Guard.....
37404	----	Tension complete, Nos. 1274C, 1560C, 2103, 8511, 32572, 32574, 37351 and two 2102....
24078	6150	Thread Guard (side of arm).....
52454	6150	" Retainer.....
910C	6150	" " Set Screw.....
37389	6112	" Take-up Crank.....
3094	6112	" " " Wedge.....
690E	6112	" " " " Screw.....
37343	6112	" " " Lever.....
12166	6112	" " " Hinge Pin.....
37344	6112	" " " Link.....
11204	6112	" " " " Hinge Pin.....
430C	6112	" " " " " Set Screw.....
37345	----	Thread Take-up Lever complete, Nos. 12166, 37343 and 37344.....
8511	6150	Thread Take-up Spring.....
37351	6150	" " " Regulator.....
446C	6150	" " " " Set Screw.....
37414	6155	Drip Pan with four 1 in. wire nails.....
*15404	----	Trade Mark.....
15405	----	" " Rivet.....

MACHINE NO. 78-3

FOR STITCHING AUTOMOBILE TOPS, CURTAINS, UPHOLSTERY;
ALSO FOR PLAIN STITCHING IN FABRICS. COMBINED UPPER AND
NEEDLE FEED. NO UNDER FEED.

This machine is the same as the 78-2 Machine with the
following exceptions:

No.	Plate	Name
*37304	----	Bed, in place of 37410.....
37326	6149	Feeding Foot, for automobile work.....
38253	6149	Lifting Presser Foot for 37326.....
37373	6153	Shuttle Bobbin Case Position Plate, in place of 37411.....
37374	6109	Shuttle Race complete, Nos. 648D, 2531, 2533, 37373, 37405 and two each 391J and 2532, in place of 37412.....
12431	6153	Shuttle Race Slide.....
12432	6153	Shuttle Race Slide complete, Nos. 4307, 12431 and two 725J.....
4307	6153	Shuttle Race Slide Spring.....
725J	6150	" " " " Screw.....
44212	6154	Drip Pan with four 1 in. wire nails, in place of 37414.....

ATTACHMENTS AND ACCESSORIES

No.	Plate	Name
12361	6150	Machine Hinge Connection.....
44139	6150	" " Plate.....
44140	----	Machine Hinge complete, Nos. 12361, 44139 and wood screw 1 1/4 in. No. 14.....
12405	6150	Machine Rest (felt).....
41400	6120	" " Pin (wood) 3 1/8 in. long....
120342	6120	Oiler (copper plated) with 120343.....
120343	6120	" Spout, 3 1/2 in. long.....
26026	6120	Screw Driver (machine).....
26485	6120	" " (shuttle tension).....
8909	6120	Wrench for 1518.....
19221	6120	" " 1619.....

BINDER ON SHANK

FOR MATTRESS WORK

No.	Plate	Name
36235	----	Binder.....
220J	6151	" Adjusting Screw.....
7806	6151	" " Washer.....
36236	----	" Shank.....
36237	6122	Binder on Shank complete, Nos. 36235, 36236 and two each 220J and 7806.....
190J	6145	Binder Screw.....
7071	6149	" " Washer.....
36238	6122	Feeding Foot.....
36239	6122	Lifting Presser Foot.....

BINDER ON SHANK

FOR FURNITURE SLIP COVERS

No.	Plate	Name
36240	----	Binder.....
220J	6151	" Adjusting Screw.....
7806	6151	" " Washer.....
36241	----	" Shank.....
36242	6122	Binder on Shank complete, Nos. 36240, 36241 and two each 220J and 7806.....
190J	6145	Binder Screw.....

BINDER ON SHANK

No.	Plate	Name
7071	6149	Binder Screw Washer.....
36238	6122	Feeding Foot.....
36239	6122	Lifting Presser Foot.....

BINDER ON SHANK

FOR ENAMELLED BINDING FOR CHAIR BOTTOMS,
SEAT CURTAINS OR OTHER SIMILAR WORK.

No.	Plate	Name
36243	----	Binder.....
233J	6123	" Adjusting Screw.....
36244	----	" Shank.....
36245	6123	Binder on Shank complete, Nos. 36243, 36244 and two 233J.....
190J	6145	Binder Screw.....
7071	6149	" " Washer.....
37326	6149	Feeding Foot.....
36246	6123	Lifting Presser Foot.....

BINDER ON SHANK

FOR BIAS BINDING, FOR TURNING UNDER BOTH
EDGES OF BINDING FOR GENERAL WORK.

No.	Plate	Name
36247	----	Binder.....
233J	6123	" Adjusting Screw.....
36244	----	" Shank.....
36248	6124	Binder on Shank complete, Nos. 36244, 36247 and two 233J.....
190J	6145	Binder Screw.....
7071	6149	" " Washer.....
37326	6149	Feeding Foot.....
36249	6124	Lifting Presser Foot.....

BINDER ON SHANK

FOR BIAS BINDING, TO TURN UNDER THE TOP EDGE ONLY,
FOR SUSPENDER ENDS AND OTHER SIMILAR WORK.

No.	Plate	Name
36250	----	Binder.....

BINDER ON SHANK

No.	Plate	Name
233J	6123	Binder Adjusting Screw.....
7806	6151	" " " Washer.....
36251	----	" Shank.....
36252	6125	Binder on Shank complete, Nos. 233J, 7806, 36250 and 36251.....
190J	6145	Binder Screw.....
7071	6149	" " Washer.....
37326	6149	Feeding Foot.....
36253	6125	Lifting Presser Foot.....

BINDER ON SHANK

FOR BINDING WITH BRAID FOR GENERAL WORK.

No.	Plate	Name
36254	----	Binder.....
233J	6123	" Adjusting Screw.....
7806	6151	" " " Washer.....
36255	----	" Shank.....
36256	6124	Binder on Shank complete, Nos. 233J, 7806, 36254 and 36255.....
190J	6145	Binder Screw.....
7071	6149	" " Washer.....
37326	6149	Feeding Foot.....
36249	6124	Lifting Presser Foot.....

BINDER ON SHANK

FOR LIGHT LEATHER OR OIL CLOTH BINDING FOR LEATHER.

No.	Plate	Name
36268	----	Binder.....
233J	6123	" Adjusting Screw.....
7806	6151	" " " Washer.....
1835	6126	" Roller.....
1521D	6126	" " Nut.....
36269	----	" Shank.....
36270	6126	Binder on Shank complete, Nos. 1521D, 1835, 36268, 36269 and two each 233J and 7806.
190J	6145	Binder Screw.....
7071	6149	" " Washer.....
36271	6126	Feeding Foot.....
36272	6126	Lifting Presser Foot.....

BINDER ON SHANK

FOR BINDING TICKET HOLDERS WITH IMITATION
LEATHER BINDING.

No.	Plate	Name
36409	----	Binder.....
220J	6151	" Adjusting Screw.....
7806	6151	" " " Washer.....
36255	----	" Shank.....
36410	6128	Binder on Shank complete, Nos. 220J, 7806, 36255 and 36409.....
190J	6145	Binder Screw.....
7071	6149	" " Washer.....
36232	6159	Feeding Foot.....
36233	6159	Lifting Presser Foot.....

BINDER ON SHANK

FOR GENERAL WORK, FOR FIRST LINE OF STITCHING,
FOR BINDING WITH TAPE, LOWER PART OF BINDING
TO EXTEND UNDER FOR SECOND LINE OF STITCHING.

No.	Plate	Name
36411	----	Binder.....
220J	6151	" Adjusting Screw.....
7806	6151	" " " Washer.....
36236	----	" Shank.....
36412	6129	Binder on Shank complete, Nos. 36236, 36411 and two each 220J and 7806.....
190J	6145	Binder Screw.....
7071	6149	" " Washer.....
18055	6145	Feeding Foot Hinge Pin.....
37356	----	" " Plate.....
37357	----	" " Shank.....
37358	6129	Feeding Foot (hinged) complete, Nos. 18055 37356 and 37357.....
37329	6129	Lifting Presser Foot.....

BINDER ON SHANK

FOR BINDING TWO PIECES OF LEATHER WITH THIN
LEATHER BINDING.

No.	Plate	Name
36406	----	Binder.....

BINDER ON SHANK

No.	Plate	Name
220J	6151	Binder Adjusting Screw.....
7806	6151	" " " Washer.....
36236	----	" Shank.....
36407	6130	Binder on Shank complete, Nos. 36236, 36406 and two each 220J and 7806.....
190J	6145	Binder Screw.....
7071	6149	" " " Washer.....
37326	6149	Feeding Foot.....
36249	6124	Lifting Presser Foot.....

BINDER ON SHANK

FOR HEAVY SEAMS.

No.	Plate	Name
121470	6156	Binder.....
233J	6123	" Adjusting Screw.....
7806	6151	" " " Washer.....
121471	6156	" Shank.....
121472	6156	Binder (adjustable) on Shank complete, Nos. 121470, 121471 and two each 233J and 7806.....
190J	6145	Binder Screw.....
7071	6149	" " " Washer.....
36232	6159	Feeding Foot.....
36233	6159	Lifting Presser Foot.....

BINDER ON SHANK

FOR OILCLOTH.

No.	Plate	Name
121473	6157	Binder.....
220J	6151	" Adjusting Screw.....
7806	6151	" " " Washer.....
36236	----	" Shank.....
121474	6157	Binder (adjustable) on Shank, complete, Nos. 36236, 121473 and two each 220J and 7806.....
190J	6145	Binder Screw.....
7071	6149	" " " Washer.....
36232	6159	Feeding Foot.....
36233	6159	Lifting Presser Foot.....

BINDER (ENGLISH)

FOR IMITATION BINDING OF SUITCASE WORK.

No.	Plate	Name
121475	6158	Binder Folder.....
1442J	6158	" " " Screw.....
121476	6158	" Plate.....
26617	6158	" Ribbon Tension Pin (bent).....
26618	6158	" " " " Plate.....
26486	6158	" " " " Pin (straight).....
25734	6158	Binder Ribbon Tension complete, Nos. 26617 26618 and seven 26486.....
190J	6145	Binder Ribbon Tension Screw.....
7071	6149	" " " " Washer.....
50004B	6158	" Screw.....
121478	6157	Feeding Foot.....
121479	6157	Lifting Presser Foot.....
121480	6157	Needle Plate for 121481.....
121481	6157	" " " 121480 with 37384 and two 1161D.....
37384	6147	Needle Plate Thread Guard.....
1161D	6147	" " " " Screw.....
121477	----	Binder (English) complete, Nos. 1442J, 25734, 121475, 121476, 121478, 121479, 121481 and two each 190J, 7071 and 50004B.....

BINDER (ENGLISH)

FOR CANVAS WORK.

No.	Plate	Name
121482	6159	Binder.....
207J	6159	" Adjusting Screw.....
121483	6159	" Plate.....
228J	6159	" Screw.....
36232	6159	Feeding Foot.....
36233	6159	Lifting Presser Foot.....
121485	6159	Needle Plate.....
121486	6159	" " " 121485 with 37384 and two 1161D.....
37384	6147	Needle Plate Thread Guard.....
1161D	6147	" " " " Screw.....
121484	----	Binder (English) complete, Nos. 228J, 36232 36233, 121482, 121483, 121486 and two 207J

BINDER (TRANSVERSE)
FOR BINDING LEATHER SHOES.

No.	Plate	Name
121487	6160	Binder (transverse).....
50163J	6160	" Adjusting Screw.....
121488	6160	" Plate.....
1423J	6160	" " Screw.....
36232	6159	Feeding Foot.....
36233	6159	Lifting Presser Foot.....
121490	6160	Needle Plate.....
121491	6160	Needle Plate 121490 with 37384 and two 1181D.....
37384	6147	Needle Plate Thread Guard.....
1181D	6147	" " " Screw.....
121489	----	Binder (transverse) complete, Nos. 1423J, 36232, 36233, 121487, 121489, 121491 and two 50163J.....

BOBBIN WINDER

(SWINGING AUTOMATIC, RIGHT HAND)

No.	Plate	Name
27540	6152	Base.....
15072	6150	Bobbin Position Pin.....
27302	6152	Frame.....
50356D	6150	" Hinge Screw.....
1620J	6150	" " " Nut.....
27303	6149	" Spring.....
27541	6152	Pulley.....
*27849	6152	Spindle.....
27538	6152	" 27849 with 15072, 27350 and 41828..
*27850	6150	" Collar.....
41828	6150	" " Pin.....
27306	6152	Spool Pin.....
27307	6152	" Stand.....
27308	6152	Spool Stand complete, Nos. 418E, 1562J, 210E 10141, 11241, 27306, 27307 and two each 2455 and wood screws 1 in. No. 10.....
11241	6150	Spool Washer (cloth).....
27312	6152	Stop Latch.....
35D	6150	" " Hinge Screw.....
2455	6151	Tension Disc.....
1562J	6151	" Regulating Thumb Nut.....
418E	6151	" Screw Stud.....

No.	Plate	Name
10141	6151	Tension Spring.....
210E	6151	" Thread Guide.....
27647	----	Bobbin Winder, Nos. 35D, 1620J, 27302, 27303, 27312, 27538, 27540, 27541, 50356D and two wood screws 1 in. No. 7.....
27544	----	Bobbin Winder (swinging automatic, right hand) complete, Nos. 27308 and 27647...

BOBBIN WINDER

(SWINGING AUTOMATIC, RIGHT HAND)

FOR POWER TABLE

No.	Plate	Name
225433	3469	Bobbin Winder and Tension Bracket Base....
225453	3470	Frame with 202277 and 225438.....
225454	3471	" Hinge Pin.....
202277	3471	" Oil Packing (wick).....
225438	3471	" " Well Cap.....
225455	3471	" Spring.....
225456	3471	" " Plunger.....
202473	3471	Pulley with 200380C.....
200380C	3471	" Set Screw.....
225381	3470	Spindle.....
225444	3471	Stop Latch.....
200056E	3471	" " Screw.....
225458	3471	" " Thumb Lever.....
225459	3471	" " " Hinge Stud.....
202478	3471	" " Trip Lever.....
200299H	3471	" " " Hinge Screw.....
225461	3471	Tension Bracket with 201499B.....
200082D	3471	" " Screw.....
228026	----	" " " Washer.....
210E	3471	" Disc.....
202407	3471	" Spring.....
201499B	3471	" Stud.....
201572B	3471	" " Thumb Nut.....
225462	----	Tension Bracket complete, Nos. 201572B, 202407, 225461 and two 210E.....
225382	3469	Bobbin Winder (swinging automatic, right hand) complete, Nos. 200056E, 200082D, 200299H, 202473, 202478, 225381, 225433, 225444, 225453 to 225456, 225458, 225462, 228026 and two each 225459 and wood screws 3/4 in. No. 12 R.H.B.....

FOOT LIFTER PARTS

No.	Plate	Name
5596	6152	Bell Crank.....
56848	----	" " 5596 with 5599 and 5601.....
5599	6152	" " Bracket.....
178E	6150	" " " Screw.....
5601	6151	" " Hinge Pin.....
5735	6152	" " Spring.....
5598	6152	Bell Crank complete, Nos. 5735 and 56848..
5670	----	Chain, length 26 in. to 35 in., with 56864 and 56865.....
Note: When ordering No. 5670, state length required		
4879	6151	Chain Connecting Link.....
56864	6151	" Hook (large).....
56865	6151	" (small).....
37346	6155	Lifting Lever with 453C.....
12415	6144	" " Connecting Rod.....
12416	6151	" " " " Joint.....
76D	6151	" " " " " Hinge Screw.....
1521E	6150	Lifting Lever Connecting Rod Lock Nut....
802D	6150	" " Hinge Screw.....
37390	6151	" " Link.....
766D	6151	" " " Hinge Screw.....
4727	6151	" " Pin.....
453C	6145	" " " Set Screw.....
2763	22161	Rock Shaft.....
12242	22161	" " Hanger with two wood screws 1 in. No. 10.....
6337	22161	Rock Shaft Lifting Bracket with two 356C..
12243	22161	" " " Hook.....
7125	22161	" " " Hook.....
356C	6151	" " " " Set Screw.....
356C	6151	" " " " Set Screw.....
2770	22161	" " Stop Dog with 356C.....
356C	6151	" " " " Set Screw.....
4880	22161	Rock Shaft complete, Nos. 2763, 2770, 7125, 12243 and two each 6337 and 12242.....
4881	6155	Treadle.....
4882	6152	" Shaft.....
4883	6152	" Spring.....
4884	6155	" Stand.....
4885	6155	Treadle complete, Nos. 4879, 4881 to 4884 and two wood screws 1 in. No. 16.....
37392	----	Foot Lifter complete, Nos. 76D, 766D, 802D, 1521E, 4727, 4880, 4885, 5598, 5670, 12415, 12416, 37346, 37390 and two 178E.....

HEMMER ON SHANK

FOR CANVAS, ENAMELLED CLOTH, THIN LEATHER, ETC.

No.	Plate	Name
36262	----	Hemmer.....
220J	6151	" Adjusting Screw.....
7806	6151	" " Washer.....
36236	----	" Shank.....
36263	6134	Hemmer on Shank complete, Nos. 36236, 36262 and two each 220J and 7806.....
190J	6145	Hemmer Screw.....
7071	6149	" " Washer.....
37326	6149	Feeding Foot.....
36264	6134	Lifting Presser Foot.....

HEMMER (ADJUSTABLE) ON SHANK

FOR CANVAS WORK.

No.	Plate	Name
121492	6156	Hemmer Folder (lower).....
121493	6156	" " (upper).....
725J	6150	" (adjusting) Screw.....
121494	6156	" Shank.....
121495	6156	Hemmer (adjustable) on Shank complete, Nos. 121492 to 121494 and four 725J.....
190J	6145	Hemmer Screw.....
7071	6149	" " Washer.....
36232	6159	Feeding Foot.....
36233	6159	Lifting Presser Foot.....

KNEE LIFTER PARTS

No.	Plate	Name
5596	6152	Bell Crank.....
56848	----	" " 5596 with 5599 and 5601.....
5599	6152	" " Bracket.....
178E	6150	" " " Screw.....
5601	6151	" " Hinge Pin.....
5735	6152	" " Spring.....
5598	6152	Bell Crank complete, Nos. 5735 and 56848..
37346	6155	Lifting Lever with 453C.....
12415	6144	" " Connecting Rod.....
12416	6151	" " " " Joint.....

No.	Plate	Name
76D	6151	Lifting Lever Connecting Rod Joint Hinge Screw.....
1521E	6150	Lifting Lever Connecting Rod Lock Nut.....
802D	6150	" " Hinge Screw.....
37390	6151	" " Link.....
766D	6151	" " Hinge Screw.....
4727	6151	" " Pin.....
453C	6145	" " Set Screw.....
2783	22161	Rock Shaft.....
7539	22161	" " Hanger with two wood screws 1 in. No. 10.....
2765	22161	Rock Shaft Knee Arm.....
2786	22161	" " " " Hub with 356C.....
356C	6151	" " " " Set Screw.....
2768	----	Rock Shaft Knee Arm complete, Nos. 2765 to 2767.....
2767	22161	Rock Shaft Knee Plate with 356C.....
356C	6151	" " " " Set Screw.....
6337	22161	" " Lifting Bracket with two 356C..
2778	22161	" " " " Hook.....
356C	6151	" " " " Set Screw.....
356C	6151	" " " " Set Screw.....
2770	22161	" " Stop Dog with 356C.....
356C	6151	" " " " Set Screw.....
12250	22161	Rock Shaft complete, Nos. 2763, 2768, 2778, 6337 and two each 2770 and 7539.....
37393	----	Knee Lifter complete (power table or stand) Nos. 76D, 766D, 802D, 1521E, 4727, 5598, 12250, 12415, 12416, 37348, 37390 and two 178E.....

NUMERICAL LIST OF PARTS

No.	Plate	Name
35D	6150	Bobbin Winder Stop Latch Hinge Screw for 27647.....
76D	6151	Lifting Lever Connecting Rod Joint Hinge Screw for 37392 and 37393.....
79C	6143	Arm Top Cover Hinge Screw.....
144D	6143	" Shaft Screw.....
145E	6109	Shuttle Race Screw.....
155C	6112	Needle Bar Connecting Stud Set Screw for 37332.....
165D	6145	Feed Regulator Lever Cap Screw.....
178F	6103	" Bar Guide Bracket Cap Screw.....
178F	6103	" " Socket Joint Cap Screw.....
178E	6150	Bell Crank Bracket Screw for 37392 and 37393.....
190J	6145	Binder Ribbon Tension Screw for 121477....
190J	6145	" Screw for 36237, 36242, 36245, 36248, 36252, 36256, 36270, 36407, 36410 and 36412
190J	6145	Feeding Foot Screw.....
190J	6145	Hemmer Screw for 36263 and 121495.....
190J	6145	Lifting Presser Foot Screw.....
190J	6145	Tension Releasing Lever Connection Extension Screw.....
207J	6159	Binder Adjusting Screw for 121484.....
212D	6103	Feed Bar Bell Crank Cap Screw.....
212D	6103	" " " " Slide Block Cap Screw for 37348.....
212D	6145	Lifting Presser Bar Connecting Link Cap Screw.....
219F	6143	Face Plate Screw.....
220J	6151	Binder Adjusting Screw for 36237, 36242, 36407, 36410, 36412 and 121474.....
220J	6151	Hemmer Adjusting Screw for 36263.....
226J	6148	Oscillating Shaft Crank Slide Block Cap Screw for 19449.....
228J	6159	Binder Screw for 121484.....
233J	6123	" Adjusting Screw for 36245, 36248, 36252, 36256, 36270 and 121472.....
233J	6145	Needle Bar Thread Guard Screw.....
284D	6145	Guide Thumb Screw.....
330D	6145	Feed Regulator Lever Clamp Screw for 37319
330D	6145	" " " Segment Screw.....
356C	6151	Rock Shaft Lifting Bracket Hook Set Screw for 6337.....
356C	6151	Rock Shaft Lifting Bracket Set Screw for 6337.....

No.	Plate	Name
356C	6151	Rock Shaft Stop Dog Set Screw for 2770....
356C	6151	" " Knee Arm Hub Set Screw for 2766
356C	6151	" " Plate Set Screw for 2767..
391J	6148	Shuttle Bobbin Case Position Plate Screw for 37374 and 37412.....
418E	6151	Bobbin Winder Tension Screw Stud for 27308
430C	6143	Arm Shaft Flanged Bushing (front) Set Screw.....
430C	6112	Thread Take-up Lever Link Hinge Pin Set Screw.....
446C	6150	Thread Take-up Spring Regulator Set Screw.
448C	6143	Arm Shaft Flanged Bushing (back) Set Screw
448C	6143	Balance Wheel Set Screw for 4370.....
448C	6143	Oscillating Rock Shaft Hinge Pin Set Screw
453C	6145	Lifting Presser Bar Lifting Bracket Set Screw for 37328.....
453C	6145	Lifting Lever Pin Set Screw for 37346.....
457C	6149	Oscillating Shaft Crank Set Screw for 37386.....
462C	6149	Shuttle Driver Set Screw for 37372.....
591F	6148	" Tension Regulating Screw for 224841.....
592E	6148	Shuttle Bobbin Case Latch Stop Screw for 224841.....
648D	6109	Shuttle Race Back Spring Screw for 37374 and 37412.....
690E	6112	Thread Take-up Crank Wedge Screw.....
691F	6145	Needle Plate Screw.....
725J	6150	Hemmer (adjusting) Screw for 121495.....
725J	6150	Shuttle Race Slide Spring Screw for 12432, for 78-3 Machine.....
748E	6143	Arm Screw (back).....
766D	6151	Lifting Lever Link Hinge Screw for 37392 and 37393.....
775E	6112	Needle Bar Connecting Link Cap Screw.....
794E	6112	" " " " Adjusting Screw for 37331.....
802D	6150	Lifting Lever Hinge Screw for 37392 and 37393.....
808F	6145	Needle Clamp Screw for 4303.....
854E	6143	Arm Screw (front).....
858C	6145	Needle Bar Crank and Feed Cam Set Screw for 37333.....
878J	6149	Oscillating Rock Shaft Hinge Pin Oil Hole Stop Screw.....
896C	6143	Crank Connecting Rod Cap Screw for 20197..
908C	6143	" " " Hinge Screw.....
910C	6150	Thread Retainer Set Screw.....

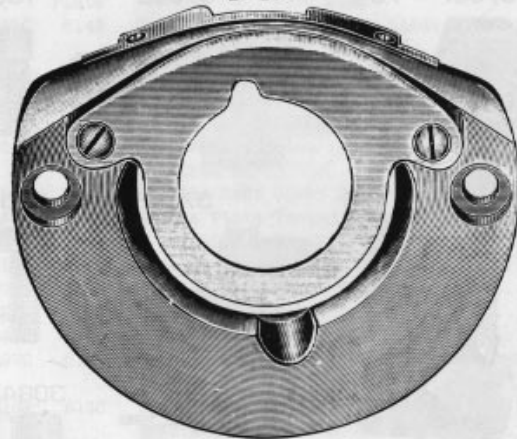
No.	Plate	Name
988C	6148	Oscillating Shaft Crank Slide Block Screw Stud for 19449.....
1053D	6109	Shuttle Race Cap Screw for 37405.....
1057E	6145	Feed Regulator Lever Clamping Screw for 37318.....
1065C	6145	Needle Bar Crank and Feed Cam Position Screw for 37333.....
1160D	6149	Shuttle Race Cover Screw for 78-2 Machine.
1161D	6147	Needle Plate Thread Guard Screw for 37381, 37382,121481,121486 and 121491.....
1210E	6149	Pressure Regulating Thumb Screw.....
1274C	6149	Tension Screw Stud for 37404.....
1423J	6160	Binder Plate Screw for 121489.....
1442J	6158	" Folder Screw for 121477.....
1497C	6103	Feed Bar Bell Crank Bracket Set Screw for 37379.....
1518J	6148	Oscillating Shaft Crank Slide Block Screw Stud Nut for 37386.....
1521E	6150	Lifting Lever Connecting Rod Lock Nut for 37392 and 37393.....
1521D	6126	Binder Roller Nut for 36270.....
1560C	6149	Tension Regulating Thumb Nut for 37404....
1562J	6151	Bobbin Winder Tension Regulating Thumb Nut for 27308.....
1619E	6143	Crank Connecting Rod Hinge Screw Nut.....
1620J	6150	Bobbin Winder Frame Hinge Screw Nut for 27647.....
1813	6145	Feed Regulator Crank Roller and Stud for 37317.....
1835	6126	Binder Roller for 36270.....
2049	6145	Feed Regulator Crank Pin.....
2049	6145	Oscillating Shaft Crank Pin.....
2049	6145	Shuttle Driver Pin.....
2102	6149	Tension Disc for 37404.....
2102	3471	Bobbin Winder Tension Disc for 225462....
2103	6149	Tension Spring for 37404.....
2106	6151	Bobbin Winder Tension Thread Guide for 27308.....
2455	6151	Bobbin Winder Tension Disc for 27308.....
2523	6148	Shuttle Bobbin Case Position Finger Rivet for 224840.....
2531	6109	Shuttle Race Back for 37374 and 37412....
2532	6109	" " " Position Pin for 37374 and 37412.....
2533	6109	Shuttle Race Back Spring for 37374 and 37412.....
2763	22161	Rock Shaft for 4880 and 12250.....
2765	22161	" " Knee Arm for 2768.....

NUMERICAL LIST OF PARTS

No.	Plate	Name
2766	22161	Rock Shaft Knee Arm Hub with 356C, for 2768.....
2767	22161	Rock Shaft Knee Plate with 356C, for 2768.
2768	-----	Rock Shaft Knee Arm complete, Nos. 2765 to 2767, for 12250.....
2770	22161	Rock Shaft Stop Dog with 356C, for 4880 and 12250.....
2778	22161	Rock Shaft Lifting Bracket Hook for 12250.
2827	6143	Face Plate Thread Guard (lower) with 8505, for 37306.....
2973	6148	Shuttle Bobbin Case Latch Lever for 15141.
2974	6148	" " " " " Fulcrum Pin, for 15141.....
2975	6148	Shuttle Bobbin Case Latch Spring for 224841.....
2996	6148	Shuttle Bobbin for 37855.....
3094	6112	Thread Take-up Crank Wedge.....
4302	6147	Needle Bar Thread Guard.....
4303	6147	" Clamp with 808F.....
4307	6153	Shuttle Race Slide Spring for 12432, for 78-3 Machine.....
4370	6154	Balance Wheel, heavy rim, 2 3/4 in. pulley with two 448C.....
4430	6143	Arm Top Cover Friction Washer.....
4727	6151	Lifting Lever Pin for 37392 and 37393.....
4784	6146	Oscillating Rock Shaft Oil Pad for 24105..
4879	6151	Chain Connecting Link for 4885.....
4880	22161	Rock Shaft complete, Nos. 2763, 2770, 7125, 12243 and two each 6337 and 12242, for 37392.....
4881	6155	Treadle for 4885.....
4882	6152	" Shaft for 4885.....
4883	6152	" Spring for 4885.....
4884	6155	" Stand for 4885.....
4885	6155	Treadle complete, Nos. 4879, 4881 to 4884 and two wood screws 1 in. No. 18, for 37392.....
5596	6152	Bell Crank for 56848.....
5598	6152	Bell Crank complete, Nos. 5735 and 56848, for 37392 and 37393.....
5599	6152	Bell Crank Bracket for 56848.....
5601	6151	" " Hinge Pin for 56848.....
5670	----	Chain, length 26 in. to 35 in., with 56864 and 56865, for 37392.....
5681	6146	Needle Bar.....
5735	6152	Bell Crank Spring for 5598.....
6337	22161	Rock Shaft Lifting Bracket with two 356C, for 4880 and 12250.....

PLATE 6109—FULL SIZE

37374



37361

1053



2531

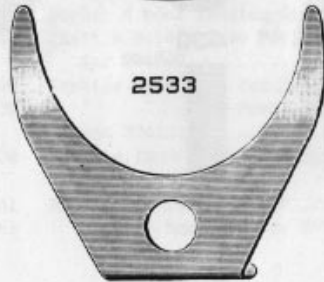
2532



648



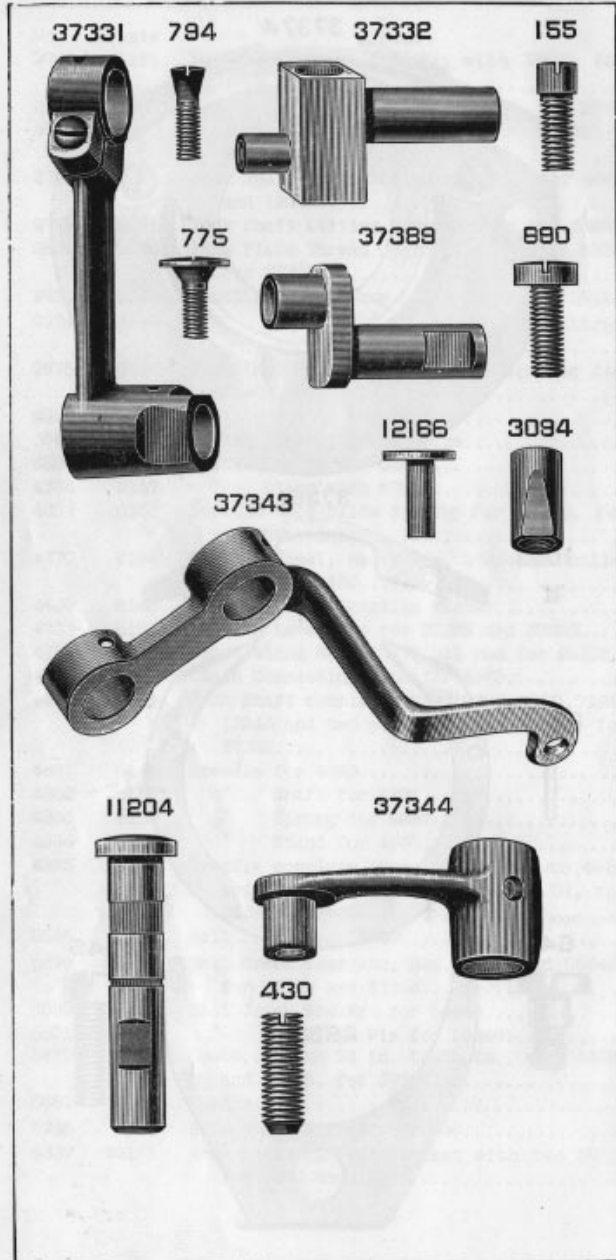
2533



145

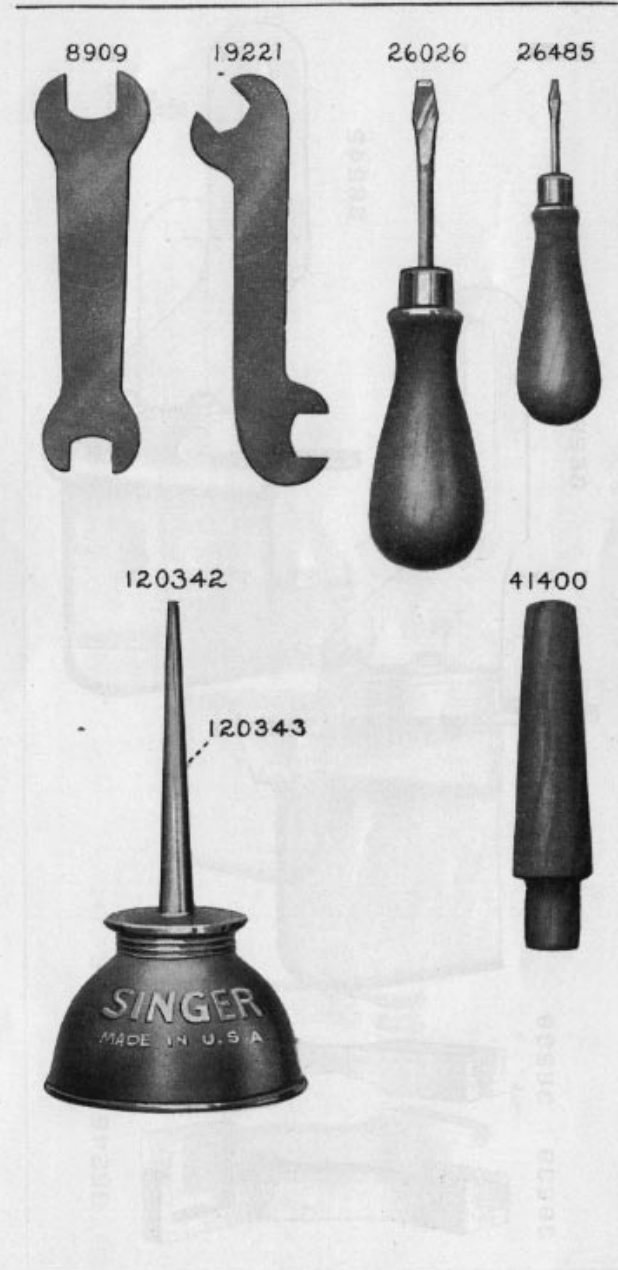


PLATE 6112—FULL SIZE



4

PLATE 6120—ONE-HALF SIZE



5

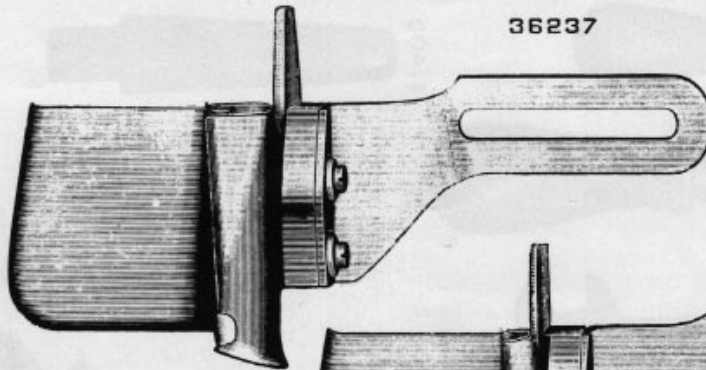
6

36239

36238



36237



36242

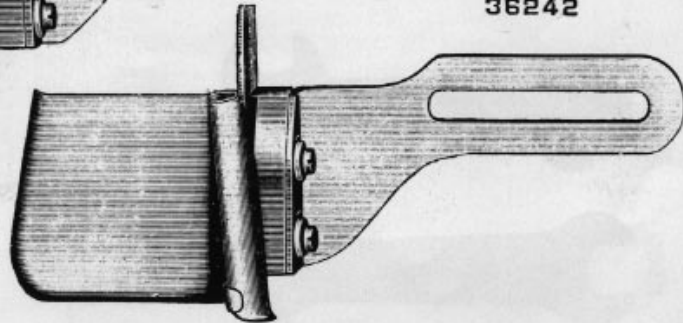
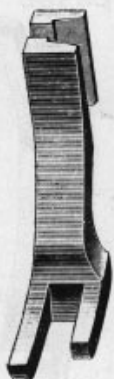


PLATE 6122-FULL SIZE

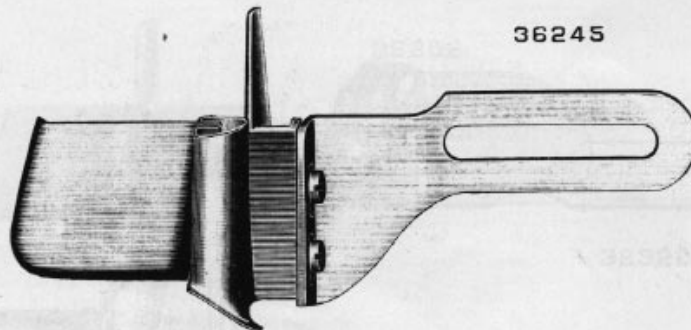


36246

37326



36245



233



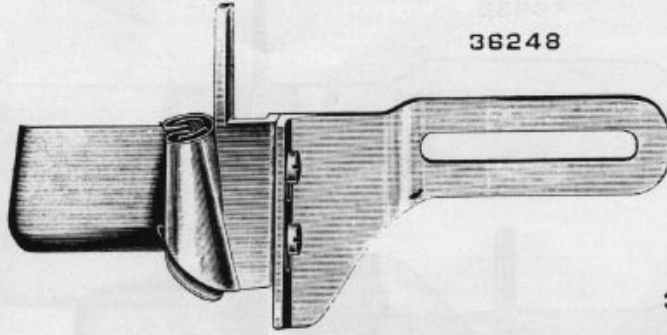
PLATE 6123-FULL SIZE

7

2

36249

37326



36248

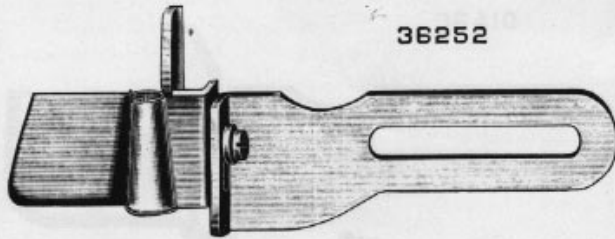
36256



PLATE 6124—FULL SIZE

36253

37326



36252

PLATE 6125—FULL SIZE

9

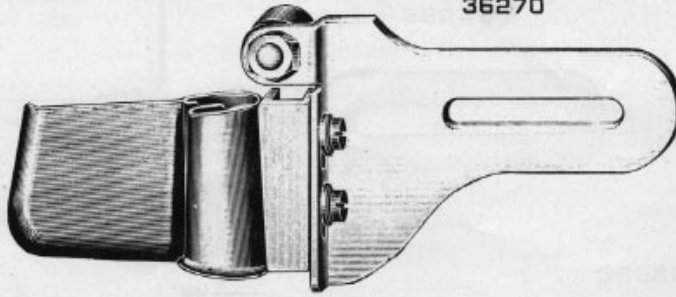
10
36272



36271



36270



1835



1521



PLATE 6126—FULL SIZE

36233



36232



36410

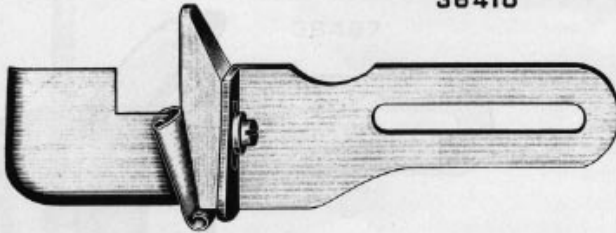


PLATE 6128—FULL SIZE

12

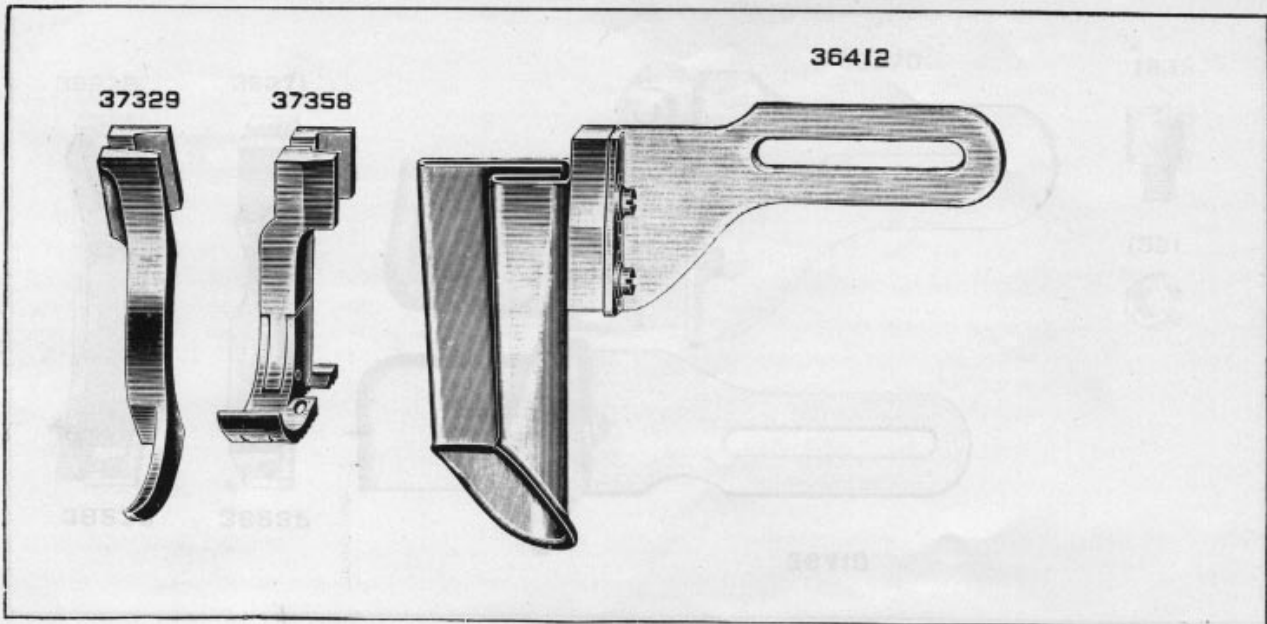


PLATE 6129—FULL SIZE

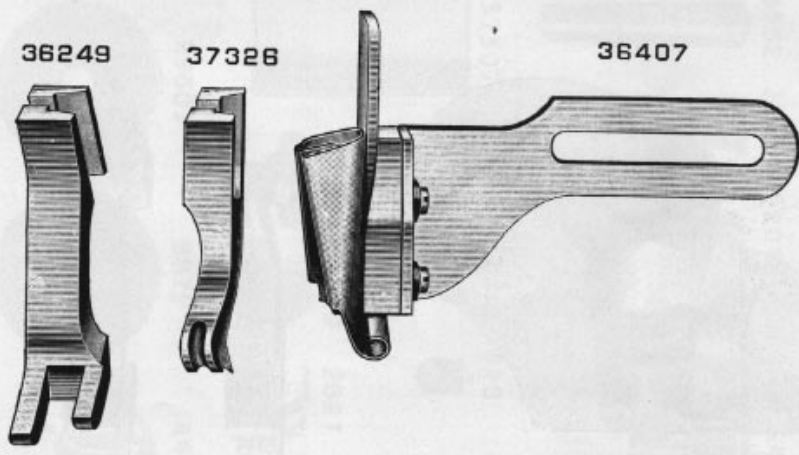
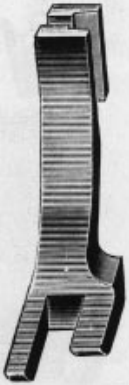


PLATE 6130—FULL SIZE

13

H

36264



37326



36263

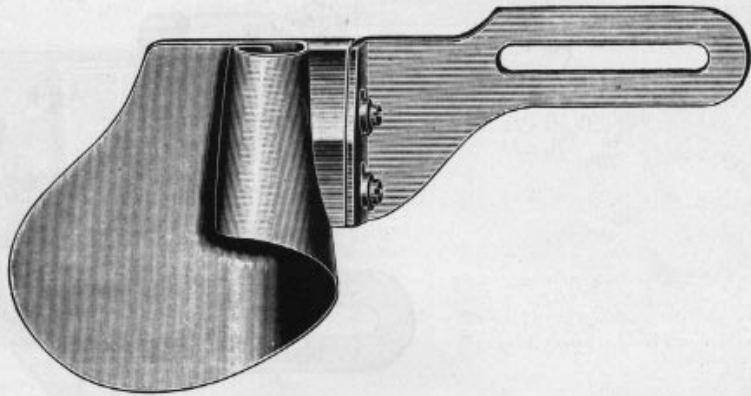


PLATE 6134—FULL SIZE

PLATE 6143-FULL SIZE

29507



854



748



12454



8582



11119



52045



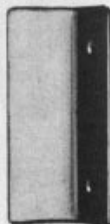
908



144



37307



430



896



448



219



79



1619



2827



8505



29601



8879



4430



47

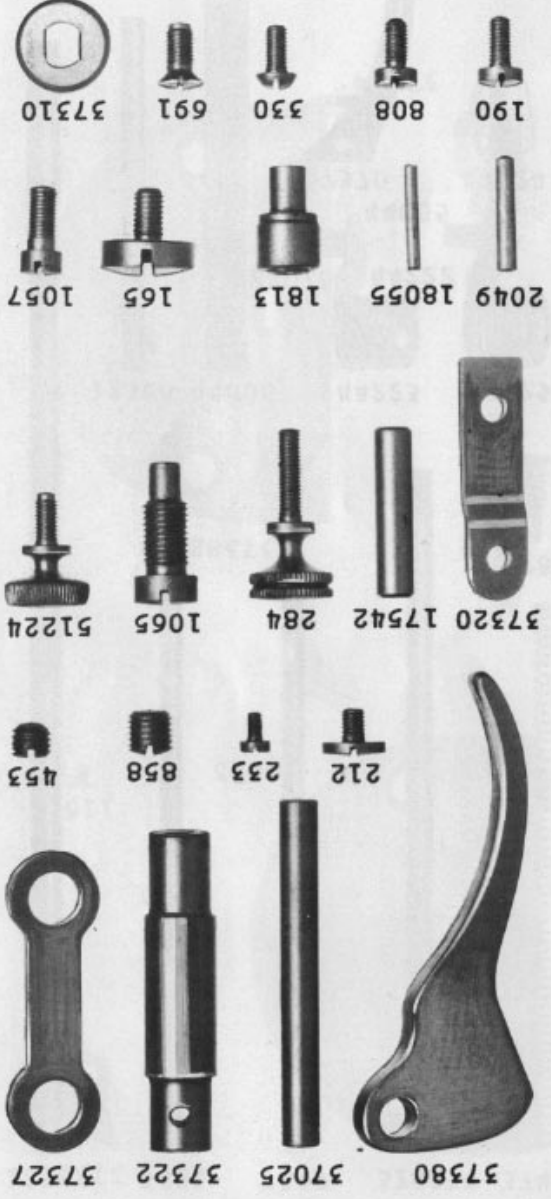


PLATE 6145-FULL SIZE

46

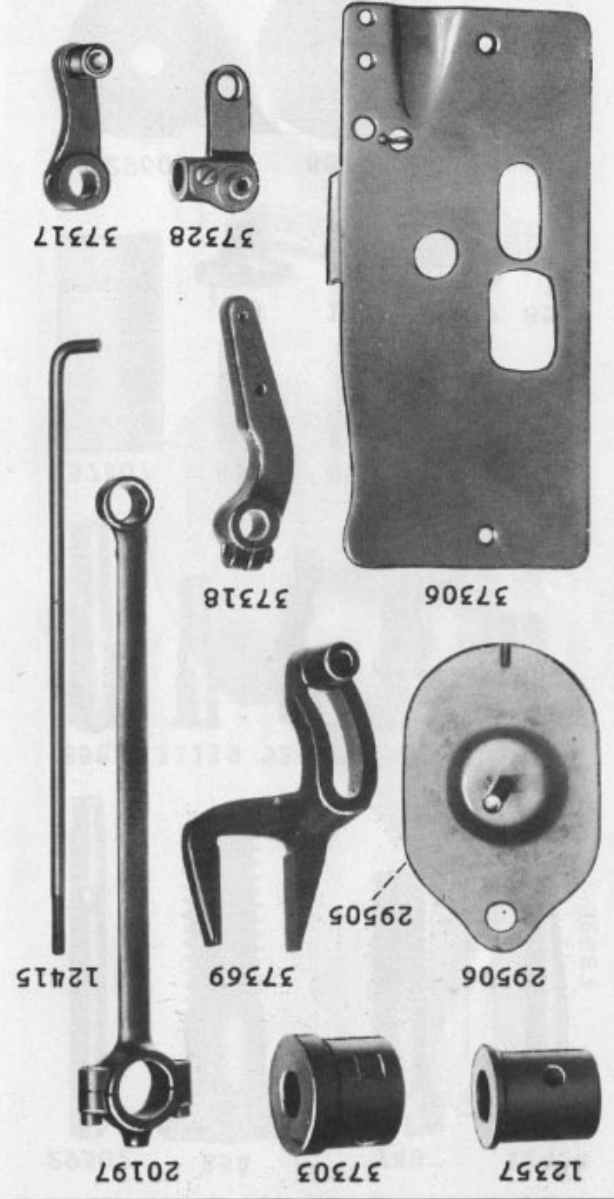
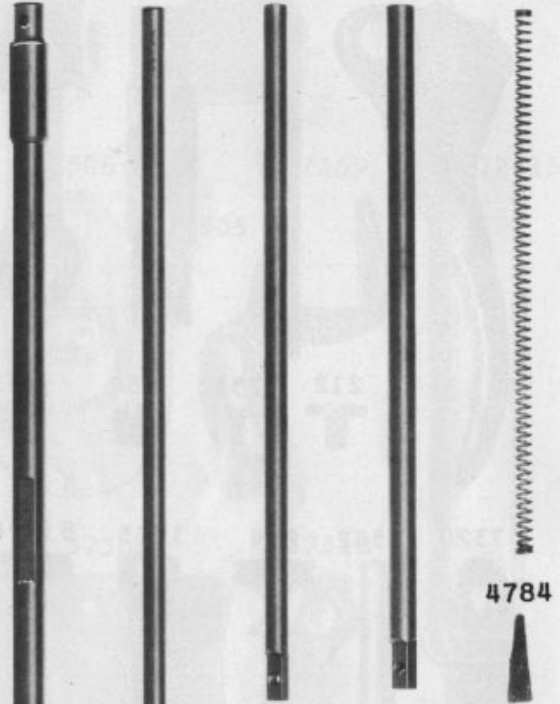


PLATE 6144-ONE-HALF SIZE

PLATE 6146 -ONE-HALF SIZE

12389 5681 7299 37023 37408



4784

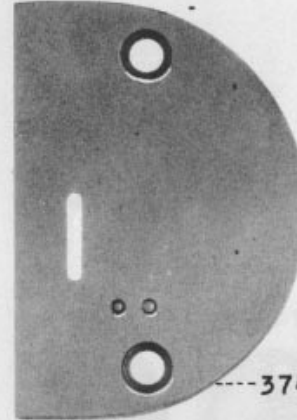
12388 44006 44223 44225



18

PLATE 6147-FULL SIZE

37381 37384

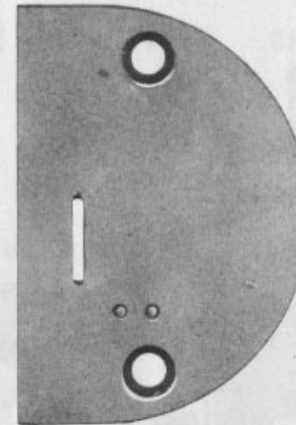


1161
T

4302



37382



4303



37424

19

PLATE 6148-FULL SIZE

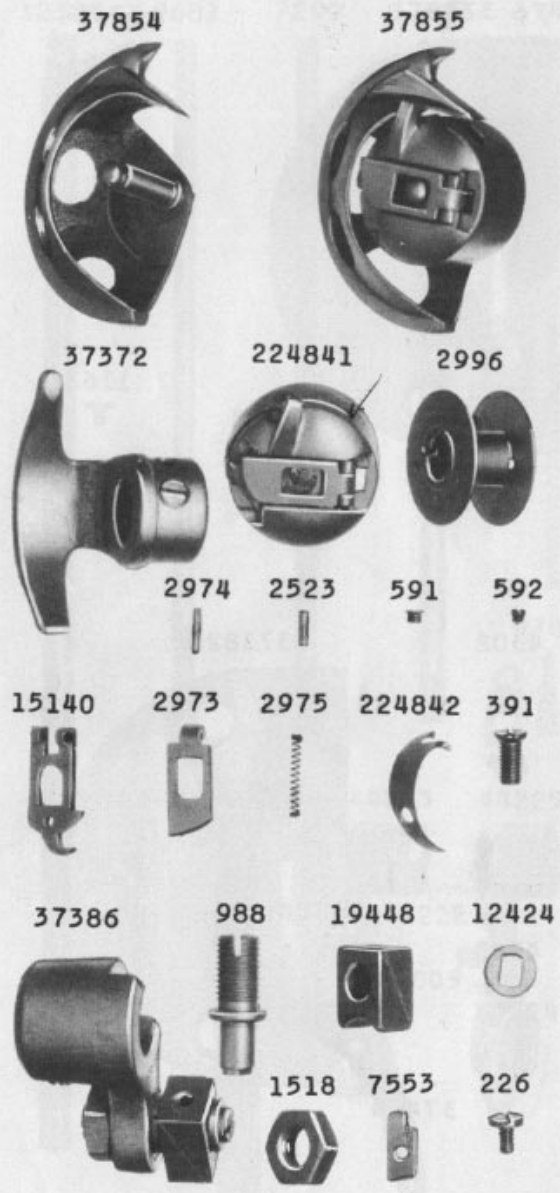


PLATE 6149-FULL SIZE

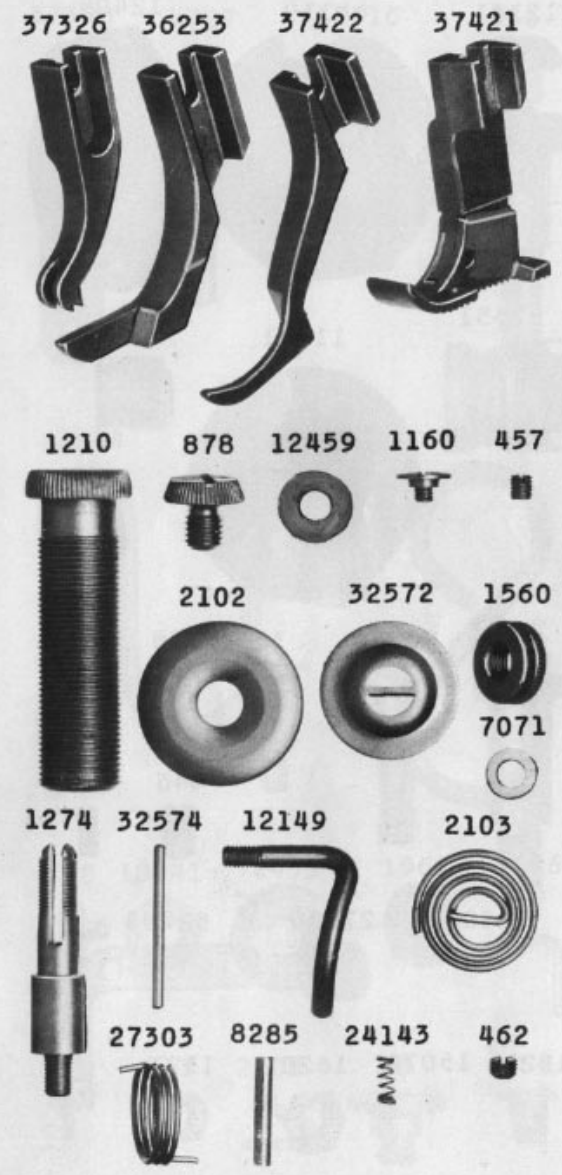


PLATE 6150-FULL SIZE

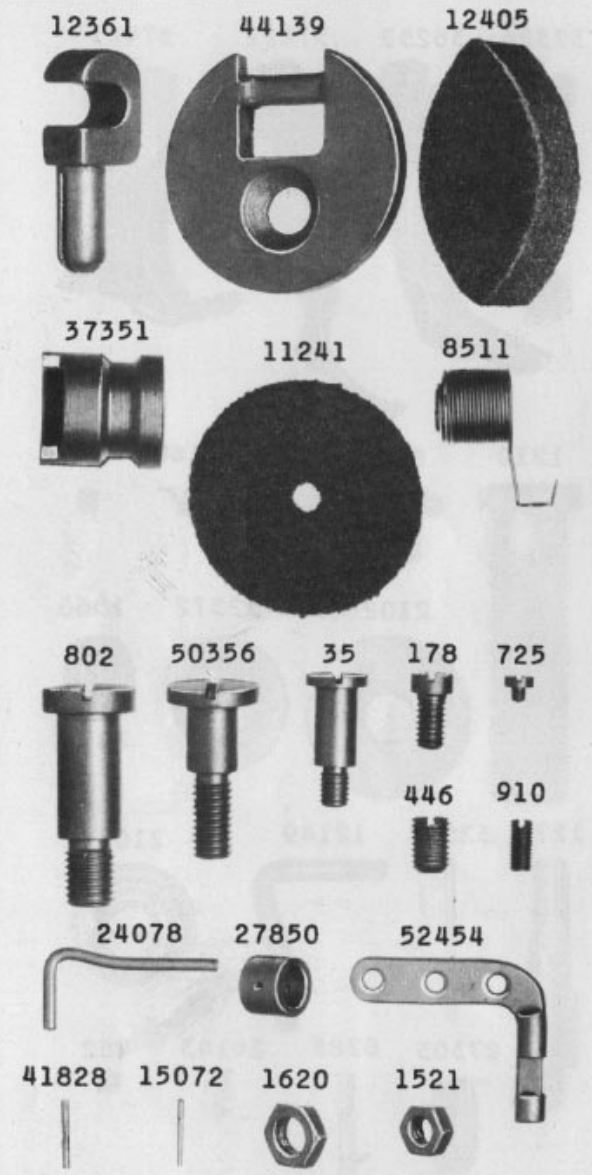


PLATE 6151-FULL SIZE

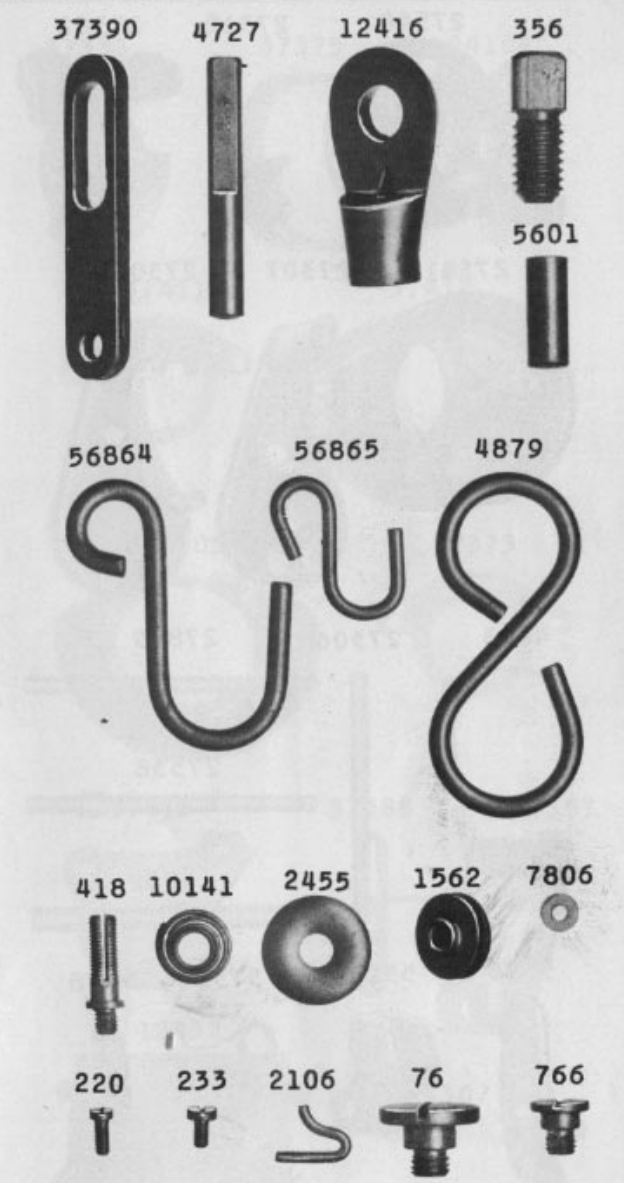


PLATE 6152-ONE-HALF SIZE



PLATE 6153-ONE-HALF SIZE

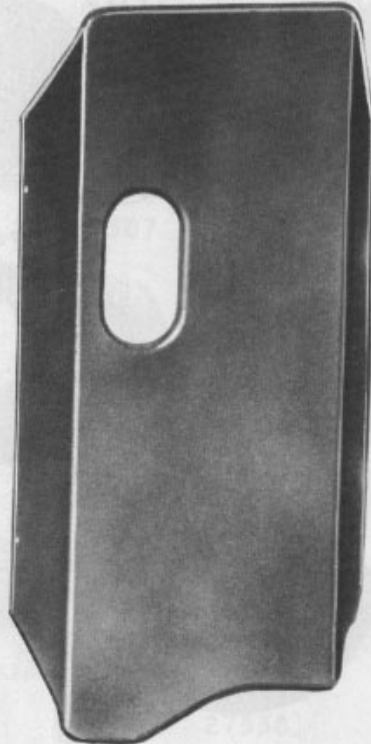


PLATE 6154-ONE-FOURTH SIZE

37377



44212



4370



PLATE 6155-ONE-FOURTH SIZE

37346



37414



4885



4881

4884

PLATE 6156-ONE-HALF SIZE

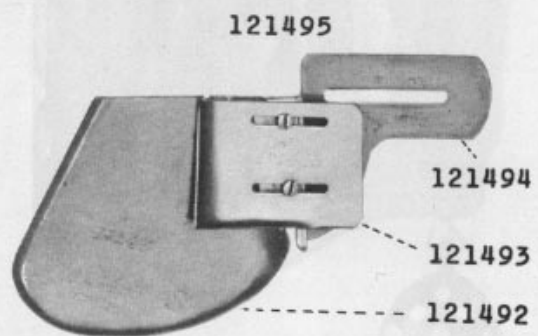
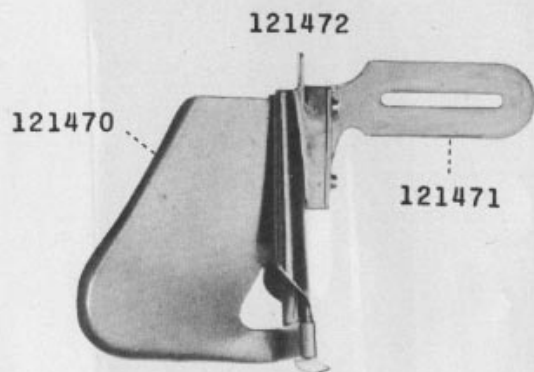
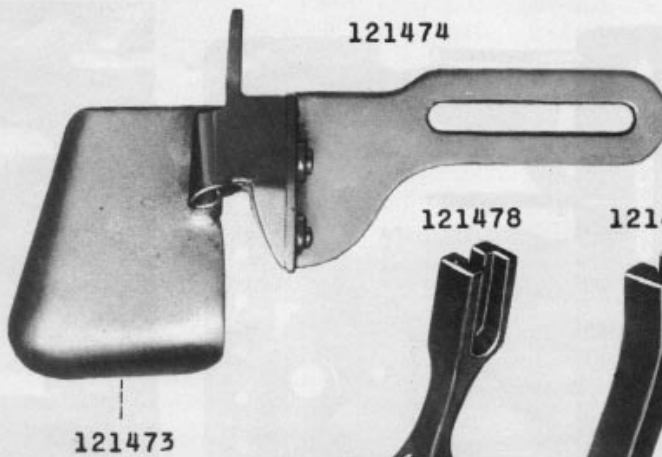
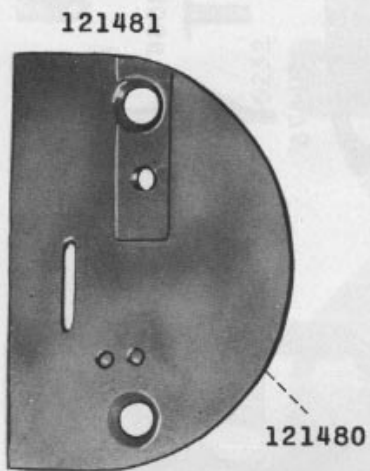


PLATE 6157-FULL SIZE



121474



29

PLATE 8158-FULL SIZE

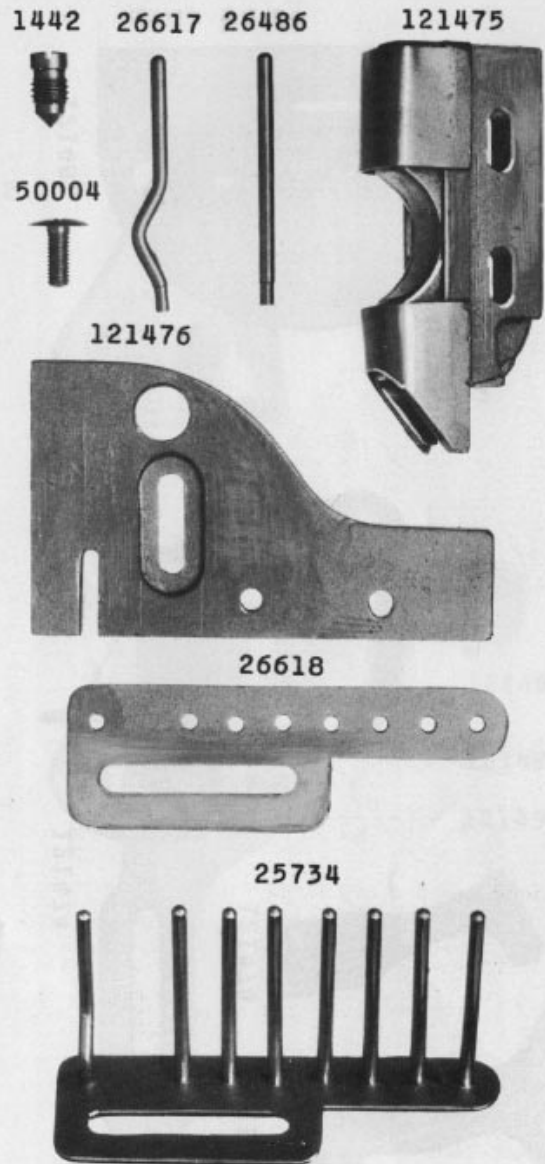


PLATE 8159-FULL SIZE

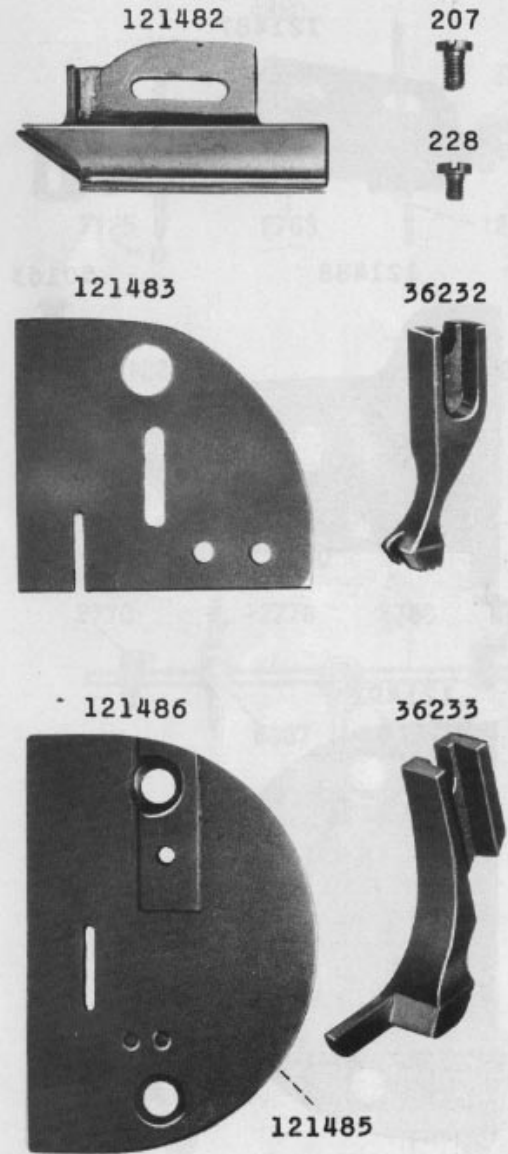
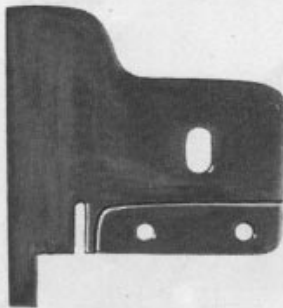


PLATE 6160-FULL SIZE

121487



121488



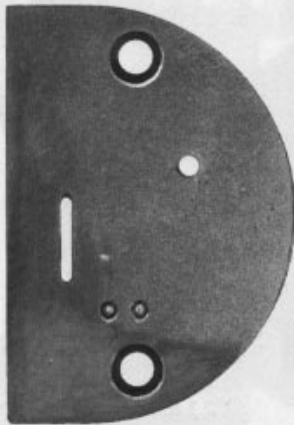
50163



1423



121491

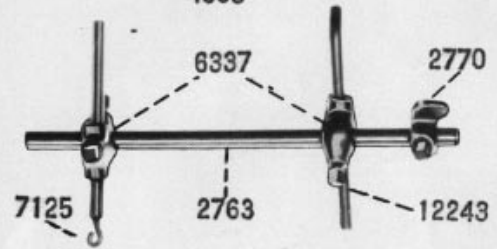


121490

32

PLATE 22161-ONE-FOURTH SIZE

4880



6337

2770

7125

2763

12243

12242



12242



12250

2770

2778

2763

2770

6337

2766

2765

2767

7539



7539



33