

Singer 69-20

Singer 69-21

Singer 81-16

FORM 8031  
JUNE, 1923  
PRINTED IN U. S. A.

**LIST**  
OF  
**PARTS**



**MACHINES**  
**Nos. 69-20, 69-21 and 81-16**

---

**THE SINGER MANUFACTURING COMPANY**

COPYRIGHT, U. S. A.,  
1915, 1916, 1917, 1922 AND 1923  
BY THE SINGER MANUFACTURING CO.  
ALL RIGHTS RESERVED FOR ALL COUNTRIES

## INDEX

	PAGE
ACCESSORIES .....	33
ATTACHMENTS AND ACCESSORIES .....	33
BOBBIN WINDER .....	34
FOOT LIFTER PARTS .....	25
IRON BASE .....	33
KNEE LIFTER PARTS .....	36
MACHINE No. 69-20 .....	7
"    "    69-21 .....	17
"    "    81-16 .....	27
NUMERICAL LIST OF PARTS .....	41
OBSOLETE PARTS .....	40
PROTECTOR .....	36
STAND FOR ELECTRIC MOTOR .....	37
STARTING LEVER AND FOOT LIFTER PARTS .....	38
TABLE BELT GUIDE .....	38
THREAD UNWINDERS .....	39

### INSTRUCTIONS FOR ORDERING

In ordering from this list, use **ONLY** the part **NUMBER** in the **FIRST** column.

The number stamped on a Sewing Machine part is in every case the number of the single part only

Every combination of parts sent out as such has its specific number, which, although not stamped on the parts, must be used when ordering the combination.

Each number always indicates the **SAME PART** in whatever list it appears, or for whatever machine.

The letters after some of the numbers indicate the style of finish only, as follows:

- A. Hardened, Polished and Plated.
- B. Polished and Plated
- C. Hardened only.
- D. Polished only.
- E. Soft, not Polished.
- F. Hardened and Polished.
- G.
- H. Blued.
- J. Plated only.
- K. Hardened and Plated.
- L. Brass or Gilt.
- M. Oxidized.
- F. Japanned.
- R. Parkerized.

These letters **MUST BE USED** when they appear in the list, and **AFTER** the number as in the list.

In this series

- 1 to 1500 and 50001 to 51500 are Screw Numbers.
- 1501 to 1800 are Nut Numbers.
- 1801 to 2000 are Roller Numbers.
- 2001 to 50000 and 52001 and upward are numbers of Machine Parts.

The figures in the second column refer only to the plates, illustrating the parts, and are **NOT TO BE USED** in ordering.

Parts marked with an asterisk (\*) are furnished only when repairs are made at factory.

### LIST OF PARTS COMPLETE

FOR

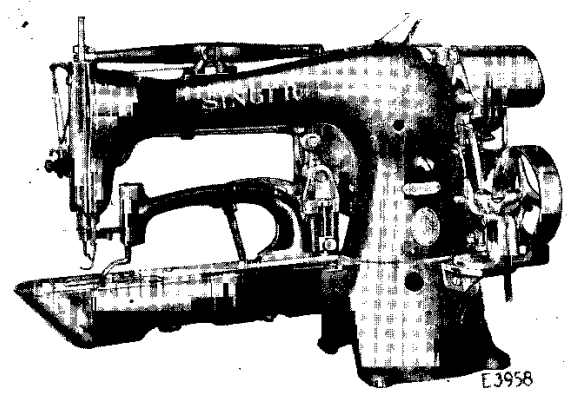

### MACHINE No. 69-20

FOR MAKING THE FERN LEAF DESIGN AT THE UPPER END OF THE CLOCKING ON HOSEIERY. MAKES 42 STITCHES IN THE COMPLETE DESIGN.

NO.	PLATE	NAME
55341	8581	Arch Clamp Foot with 55342.....
39206	8581	" " " Lifter with 17866.....
	190d	5556 " " " " Screw.....
55342	8581	" " " Lifting Stud.....
55343	8581	" " " Plate.....
	217j	5556 " " " " Screw.....
39303	8581	" " " Spring.....
	217j	5556 " " " " Screw (lower)...
	1175j	8581 " " " " " (upper)...
55344	5043	" " Frame.....
14079	8581	" " " Dowel Pin.....
	181d	5021 " " " Screw.....
55345	—	Arch Clamp complete, Nos. 810r, 1175r, 1654c, 18489, 39303, 55341, 55343, 55344, 55348, 55349, 55351, two each 181d, 14079 and five 217j.....

## PARTS FOR MACHINE No. 69-20

NO.	PLATE	NAME
*18439	—	Arm with 4449, 17844 and two 164E.....
4389	8581	" Dowel Pin.....
4448	3722	" Oil Tube for intermediate bearing...
880E	3724	" Screw.....
17702	3728	" Shaft.....
17703	5001	" " Bushing (back).....
50333c	8581	" " " Adjusting Screw.....
1520E	3724	Arm Shaft Bushing (back) Adjusting Screw Nut.....
*4449	—	Arm Shaft Bushing (front).....
18498	5044	Belt Cover.....
39290	5001	" " Bracket with 184E and 17741
184E	5021	" " " Screw Stud.....
17741	8581	" " " Stud.....
217D	5556	" " Screw.....
39222	5001	" Shifter.....
39223	8581	" " Clamp.....
1255D	5021	" " " Screw.....
4292	5045	Crank Connecting Rod with 4349 and two 158E.....
*4349	—	Crank Connecting Rod Cap.....
158E	3724	" " " " Screw.....
375c	3724	" " " Hinge Screw.....
1518E	3718	" " " " Nut.....
*55346	—	Cylinder.....
18388	8581	" Block.....
1300D	8581	" " Screw.....
55347	5046	" End Cover.....
17724	5001	Face Plate.....
*63736	—	" " 17724 with 2105.....
17725	—	Face Plate complete, Nos. 448c, 600c, 1560c, 2103, 2107, 2124, 2127, 63736 and two each 233D and 2102.....
164D	3724	Face Plate Screw.....
2107	3722	" " Thread Guard.....
233D	3722	" " " Screw.....
55376	5045	Feed Across Connection with 21358, 55377 and four 1057E.....
55379	—	Feed Across Connection 55376 with 50598c and 55382.....
*21358	—	Feed Across Connection Cap (lower).....
1057E	5047	" " " " " Screw.....
*55377	—	" " " " (upper).....
1057E	5047	" " " " " Screw.....
18356	5045	" " Regulator with 1952.....

## PARTS FOR MACHINE No. 69-20

NO.	PLATE	NAME
50598c	5047	Feed Across Regulator Adjusting Ball Screw Stud.....
1676c	5047	Feed Across Regulator Adjusting Ball Screw Stud Nut.....
17738	5047	Feed Across Regulator Adjusting Ball Screw Stud Nut Washer.....
18357	5047	Feed Across Regulator Hinge Stud.....
690D	5047	" " " " " Clamp- ing Screw.....
1952	5047	Feed Across Regulator Roller and Stud...
18358	5046	" " Shaft.....
18359	5047	" " " Collar with two 200F..
200F	5047	" " " Set Screw.....
18421	5047	" " " Crank (back) with 160E and 200c.....
55382	5047	Feed Across Shaft Crank (back) Ball Stud
200c	5047	" " " " " Set Screw.....
160E	5047	Feed Across Shaft Crank (back) Clamping Screw.....
18362	5007	Feed Across Shaft Crank (front) with 160E and 18363.....
160E	5047	Feed Across Shaft Crank (front) Clamping Screw.....
18363	5007	Feed Across Shaft Crank (front) Stud.....
18364	5007	" " " " " Slide Block.....
18410	—	Feed Cam with 17874 and two each 190D and 1192c.....
18415	5007	Feed Cam Driving Worm with 1441c and 1442c.....
1442c	5021	Feed Cam Driving Worm Position Screw
1441c	5021	" " " " Set Screw.....
17797	5048	" " " " Wheel with 453c.....
3012	3722	Feed Cam Driving Worm Wheel Pin.....
453c	5007	" " " " " Set Screw.....
18384	5007	" " Pin.....
1192c	3724	" " Set Screw.....
18416	5046	" " Shaft.....
18417	5049	" " " Bracket.....
1177D	5047	" " " " Screw (back)...
1193D	3724	" " " " " (front)...
1653c	3724	" " " Nut.....
55348	8575	" Plate.....
*18437	5046	" " Carrier Bar.....

NO.	PLATE	NAME
55349	---	Feed Plate Carrier Bar 18437 with 934J, 1195E, 1221c, 18390, 55350, 55355, two 55300 and four 17806.....
55350	5047	Feed Plate Carrier Bar Block.....
55351	8575	" " " " " Cover.....
1221c	5007	" " " " " Screw.....
55300	8576	" " " " " Steady Pin.....
17805	5007	" " " " " Pivot Block.....
1194D	5007	" " " " " Screw.....
18390	5007	" " " " " Plate.....
934J	5007	" " " " " Screw.....
1654c	8576	" " " " " Nut.....
17806	8576	" " " " " Position Stud.....
1195E	8576	" " " " " Screw Stud.....
55352	5048	" " " " " Regulator with 1953.....
55353	5048	" " " " " Bracket with 690D, 39310 and two 160D.....
55354	---	Feed Regulator Bracket 55353 with 18356, 18357, 55352 and 55356.....
*39310	---	Feed Regulator Bracket Cap.....
160D	5047	" " " " " Screw.....
8589	3722	" " " " " Dowel Pin.....
1177E	5047	" " " " " Screw.....
17744	5047	" " " " " Hinge Stud.....
55355	5047	" " " " " Post.....
18489	3759	" " " " " Guide.....
810J	3759	" " " " " Cap Screw.....
1953	5021	" " " " " Roller and Screw Stud with 1655c and 14017.....
1655c	5021	Feed Regulator Roller and Screw Stud Nut.....
14017	5047	" " " " " " " " Washer.....
55356	8575	Feed Regulator Swivel.....
1191D	5047	" " " " " Thumb Screw.....
55319	8576	Knife (needle thread).....
55320	8576	" (shuttle thread).....
18370	5044	" Bar with 18373 and two 17822.....
55357	8576	" " " " " Cap.....
219D	8576	" " " " " Screw.....
18372	5016	" " " " " Connection with 17917.....
190D	5556	" " " " " Screw.....
7071	8576	" " " " " Washer.....
17915	5016	" " " " " Slide Block.....
17917	---	" " " " " " " " 17915 with 17916.....
17916	5016	Knife Bar Connection Slide Block Stud.....

NO.	PLATE	NAME
39297	5016	Knife Bar Driving Lever with 190D, 1420E, 17919 and 39298.....
1382F	5016	Knife Bar Driving Lever Hinge Screw.....
1681c	5016	" " " " " " " Nut.....
39298	5016	" " " " " Lock Stud.....
17919	5016	" " " " " " " Spring.....
190D	5556	" " " " " " " " Screw.....
1420E	5016	Knife Bar Driving Lever Lock Stud Stop Screw.....
18373	8576	Knife Bar Rack.....
17822	8576	" " " " " Rivet.....
39235	5048	" " " " " Cam Lever Body.....
39409	---	" " " " " 39235 with 39460.....
39329	5048	Knife Cam Lever complete, Nos. 19793 and 39409.....
18470	5048	Knife Cam Lever Bracket with 1177D.....
8589	3722	" " " " " Dowel Pin.....
670E	5021	" " " " " Screw.....
50029c	3759	" " " " " Hinge Screw.....
18471	3759	" " " " " " " Bushing.....
*18472	---	" " " " " " " " 18471 with 50029c.....
1177D	5047	Knife Cam Lever Hinge Screw Bushing Clamping Screw.....
1980	3759	Knife Cam Lever Roller and Screw Stud with 1654c.....
1654c	8576	Knife Cam Lever Roller and Screw Stud Nut.....
39330	3759	Knife Cam Lever Slide with 1980.....
39460	---	" " " " " 39330 with 1255D and 39331.....
1255D	5021	Knife Cam Lever Slide Screw.....
39331	3759	" " " " " " " Washer.....
19793	8576	" " " " " Steady Pin.....
17825	8576	" " " " " Holder with 17826, 17830 and two 7298.....
55323	---	Knife Holder 17825 with 1198c, 17829, 55319 and 55320.....
17826	8576	Knife Holder Pinion.....
7298	8576	" " " " " Dowel Pin.....
17827	8576	" " " " " Stud.....
17828	8576	" " " " " Bracket with 17827.....
50018F	5021	Knife Holder Pinion Stud Bracket Screw.....
1698c	5021	" " " " " " " " Nut.....

NO.	PLATE	NAME
1198c	8576	Knife Screw .....
55321	8576	" (stationary) .....
*55322	8576	" " Bracket .....
42639	8576	" " " Pin .....
50117J	8576	" " " Screw .....
17829	8576	" Thread Holder .....
17830	8576	" " " Position Pin .....
17831	5046	Needle Bar with 237F .....
*39203	3718	" " Connecting Link .....
63756	—	" " " " 39203 with 21629 .....
377c	3718	Needle Bar Connecting Link Hinge Screw
1518E	3718	" " " " " " "
		Nut .....
21629	3718	Needle Bar Connecting Stud with 155c...
155c	3718	" " " " " Set Screw..
39350	5045	" " Thread Nipper Driving Lever (adjustable) with 39351 and two 335d
39351	3759	Needle Bar Thread Nipper Driving Lever Extension .....
335d	3759	Needle Bar Thread Nipper Driving Lever Extension Screw .....
1196c	3721	Needle Bar Thread Nipper Driving Lever Hinge Screw .....
39352	5045	Needle Bar Thread Nipper Driving Lever Spring .....
17834	3718	Needle Bar Thread Nipper Lever with 17835 .....
17835	3718	Needle Bar Thread Nipper Lever Bushing
1200d	3718	" " " " " Hinge Screw .....
39276	8576	Needle Bar Thread Nipper Lever Spring
1329d	8576	" " " " " " "
		Screw .....
17837	5045	Needle Bar Thread Nipper Rod .....
17838	3718	" " " " " Adjusting Stud .....
1651E	5021	Needle Bar Thread Nipper Rod Adjusting Stud Lock Nut .....
17839	3718	Needle Bar Thread Nipper Rod Arm with 196F .....
196F	3718	Needle Bar Thread Nipper Rod Arm Set Screw .....
17840	5001	Needle Bar Thread Nipper Rod Support
190d	5556	" " " " " " "
		Screw .....
237F	3724	Needle Set Screw .....

NO.	PLATE	NAME
*6022	5001	Oscillating Rock Shaft (steel) with 4784..
55278	—	Oscillating Rock Shaft complete, Nos. 1513J, 6022 and 6489 .....
6489	5001	Oscillating Rock Shaft Hinge Pin .....
1513J	3724	" " " " " Nut .....
4784	8576	" " " Oil Pad .....
18385	5046	" Shaft .....
18386	—	" Crank .....
18387	5017	Oscillating Shaft Crank complete, Nos. 237F, 1519E, 15171 and 18386 .....
2049	5017	Oscillating Shaft Crank Pin .....
237F	5017	" " " Set Screw .....
15170	5017	" " " Slide Block .....
229d	5017	" " " " " Cap Screw .....
12424	5017	Oscillating Shaft Crank Slide Block Cap Screw Washer .....
1035c	5017	Oscillating Shaft Crank Slide Block Screw Stud .....
1519E	5017	Oscillating Shaft Crank Slide Block Screw Stud Nut .....
15171	5017	Oscillating Shaft Crank Slide Block com- plete, Nos. 229d, 1035c, 12424 and 15170
2058	5046	Presser Bar .....
17841	3718	" " Collar with two 196F .....
196F	3718	" " " Set Screw .....
17842	3718	" " Guide Bracket with 453c .....
453c	5007	" " " " Set Screw .....
17843	5045	" " Lifting Lever .....
17844	5049	" " " Bracket .....
164E	3724	" " " " " Screw .....
1201c	5021	" " " " Hinge Screw .....
17845	5046	" " " " Rod .....
17846	—	" " " " Chain .....
8414	5001	" " Spring .....
17941	5049	Pulley (loose) 2 7/8 in. diam .....
17848	5049	" " Bushing .....
2269	3722	" " " Position Pin .....
1202d	3724	" " Cap Screw .....
17942	5049	" (tight) 2 7/8 in. diam., with 2269...
2022	3722	" " Pin .....
17955	—	Pulleys complete, Nos. 1202d, 1206c, 17848, 17854, 17941 and 17942 .....
2996	5017	Shuttle Bobbin .....
15140	5017	" " Case Latch .....
2973	5017	" " " " Lever .....

## PARTS FOR MACHINE No. 69-20

NO.	PLATE	NAME
2974	5017	Shuttle Bobbin Case Latch Lever Fulcrum Pin.....
2975	5017	Shuttle Bobbin Case Latch Spring.....
592E	5017	" " " " Stop Screw...
15141	—	" " " " Hinge, Nos. 2973, 2974 and 15140.....
55358	—	Shuttle Bobbin Case Position Finger.....
2523	5017	" " " " " Rivet
55359	8577	Shuttle Bobbin Case complete, Nos. 591F, 592E, 2523, 2975, 15141, 55358 and 55360.....
21562	5017	Shuttle Body.....
591F	5017	" Tension Regulating Screw.....
55360	8577	" " Spring.....
55361	—	Shuttle, 1 $\frac{1}{4}$ in. diam., Nos. 2996, 21562 and 55359.....
*2542	—	Shuttle Driver.....
2441	5017	" " 2542 with two 462c.....
2049	5017	" " Pin.....
462c	5017	" " Set Screw.....
55362	—	" Race Body.....
21623	8577	" " Cap.....
662D	8577	" " " Screw.....
2523	5017	" " " Steady Pin.....
55363	8577	" " Ring.....
18413	8577	" " " Spring.....
1289D	8577	" " " " Screw.....
55364	8577	Shuttle Race (flexible) complete, Nos. 662D, 2523, 21623, 55362, 55363 and two each 1289D and 18413.....
171D	8577	Shuttle Race Screw.....
17853	5048	Starting Lever.....
1262c	5021	" " Hinge Screw.....
1662c	5021	" " " " Nut.....
17886	5048	" " Pitman.....
17854	3721	Stop Cam.....
17855	3721	" " Interlocking Rod.....
55387	—	" " " " Case.....
18492	5049	" " " " " 55387 with 18443 and two 193D.....
55285	—	Stop Cam Interlocking Rod Case 18492 with 1318D, 17855, 17863, 17864, 39222, 39223 and two 1255D.....
39346	5049	Stop Cam Interlocking Rod Case Bracket

## PARTS FOR MACHINE No. 69-20

NO.	PLATE	NAME
55304	—	Stop Cam Interlocking Rod Case Bracket complete, Nos. 1182E, 1196c, 1204E, 1254c, 1262c, 1508E, 1662c, 17853, 17859, 17861, 17862, 17872, 17873, 39346, 55285 and two 898D.....
18493	—	Stop Cam Interlocking Rod Case Bracket 55304 with 39343, 39344 and two 1186D
16532	3722	Stop Cam Interlocking Rod Case Bracket Dowel Pin.....
1343E	5021	Stop Cam Interlocking Rod Case Bracket Screw.....
1204E	3721	Stop Cam Interlocking Rod Case Hinge Screw.....
17859	5048	Stop Cam Interlocking Rod Case Socket Joint.....
898D	3721	Stop Cam Interlocking Rod Case Socket Joint Cap Screw.....
39343	5049	Stop Cam Interlocking Rod Case Spring (flat).....
430c	3759	Stop Cam Interlocking Rod Case Spring Adjusting Screw.....
1520E	3759	Stop Cam Interlocking Rod Case Spring Adjusting Screw Nut.....
39344	3759	Stop Cam Interlocking Rod Case Spring Bracket with 430c and 1520E.....
1186D	5021	Stop Cam Interlocking Rod Case Spring Bracket Screw.....
17861	3721	Stop Cam Interlocking Rod Case Stop Stud.....
1254c	5021	Stop Cam Interlocking Rod Case Stop Stud Screw Bushing.....
1508E	5021	Stop Cam Interlocking Rod Case Stop Stud Screw Bushing Lock Nut.....
17862	3721	Stop Cam Interlocking Rod Case Stop Stud Spring.....
18443	8581	Stop Cam Interlocking Rod Case Wearing Block.....
193D	5587	Stop Cam Interlocking Rod Case Wearing Block Screw.....
17863	3721	Stop Cam Interlocking Rod Spring.....
17864	3721	" " " " Stop.....
1318D	8581	" " " " " Screw..
3012	3722	" " Pin.....
1206c	3721	" " Screw.....
2102	3722	Tension Disc.....
1560c	3722	" Regulating Thumb Nut.....



NO.	PLATE	NAME
600c	3722	Tension Screw Stud.....
448c	3722	" " " Set Screw.....
2103	3722	" Spring.....
2105	3722	" Thread Guard.....
*55302	—	Thread Take-up Cam.....
18392	5045	" " " 55302 with 446c....
3012	3722	" " " Pin.....
446c	3724	" " " Set Screw.....
*18393	5049	" " Lever with 1822.....
55283	—	" " " 18393 with 79c....
79c	5021	" " " Hinge Screw.....
1822	5021	" " " Roller and Stud..
2124	3722	" " Spring.....
2127	3722	" " " Regulator Plate
233d	3722	" " " " " " "
		Adjusting Screw.....
55365	8576	Thread Wiper Body.....
1207d	7229	" " " Hinge Screw.....
17866	7229	" " " Hook.....
17867	7229	" " " Support.....
641c	5021	" " " " Set Screw...
17868	7229	" " " Wire.....
337d	3718	" " " " Screw.....
17869	7229	" " " " " Washer.
55366	—	Throat Plate with 55322 and two 42639..
55367	8578	" " 55366 with 55326 and two
		1208d.....
55326	8578	Throat Plate Needle Hole Bushing.....
1208d	8578	" " " " " Screw
55368	—	Throat Plate complete, Nos. 1698c, 17828,
		50018f, 50117j, 55321, 55323 and 55367
691f	3724	Throat Plate Screw.....
17872	3721	Trip Lever.....
1196c	3721	" " Hinge Screw.....
17873	3721	" " Spring.....
1182E	8576	" " " Screw.....
17874	7229	Tripping Point.....
190d	5556	" " " Screw.....

## LIST OF PARTS COMPLETE

FOR

## MACHINE No. 69-21

FOR MAKING THE ARROW HEAD DESIGN AT THE UPPER END  
OF THE STEM OF CLOCKING ON HOSIERY. MAKES  
36 STITCHES IN THE COMPLETE DESIGN.

NO.	PLATE	NAME
55369	8575	Arch Clamp Foot with 63726.....
17708	8575	" " " Lifter with 17866.....
190d	5556	" " " " Screw.....
63726	8575	" " " Lifting Stud.....
17960	8581	" " " Plate.....
217j	5556	" " " " Screw.....
39303	8581	" " " Spring.....
217j	5556	" " " " Screw (lower)...
1175j	8581	" " " " " (upper)...
55370	5043	" " Frame.....
14079	8581	" " " Dowel Pin.....
181d	5021	" " " Screw.....
55371	—	Arch Clamp complete, Nos. 810r, 1175r,
		1654c, 17960, 18367, 18489, 39303,
		55369, 55370, 55373, 55374, two each
		181d, 14079 and five 217j.....
*18439	—	Arm with 4449, 17844 and two 164E.....
4389	8581	" Dowel Pin.....
4448	3722	" Oil Tube for intermediate bearing...
880E	3724	" Screw.....
17702	3728	" Shaft.....
17703	5001	" " Bushing (back).....
50333c	8581	" " " " Adjusting
		Screw.....
1520E	3724	Arm Shaft Bushing (back) Adjusting
		Screw Nut.....
*4449	—	Arm Shaft Bushing (front).....
18498	5044	Belt Cover.....
39290	5001	" " Bracket with 184E and 17741.
184E	5021	" " " Screw Stud.....
17741	8581	" " " Stud.....
217d	5556	" " Screw.....
39222	5001	" Shifter.....
39223	8581	" " Clamp.....
1255d	5021	" " " Screw.....

NO.	PLATE	NAME
4292	5045	Crank Connecting Rod with 4349 and two 158E.....
*4349	—	Crank Connecting Rod Cap.....
158E	3724	“ “ “ “ “ Screw.....
375c	3724	“ “ “ “ “ Hinge Screw.....
1518E	3718	“ “ “ “ “ Nut.....
*18352	—	Cylinder.....
18388	8581	“ “ Block.....
1300D	8581	“ “ Screw.....
55347	5046	“ “ End Cover.....
17724	5001	Face Plate.....
*63736	—	“ “ 17724 with 2105.....
17725	—	Face Plate complete, Nos. 448c, 600c, 1560c, 2103, 2107, 2124, 2127, 63736 and two each 233D and 2102.....
164D	3724	Face Plate Screw.....
2107	3722	“ “ Thread Guard.....
233D	3722	“ “ “ “ “ Screw.....
55376	5045	Feed Across Connection with 21358, 55377 and four 1057E.....
55379	—	Feed Across Connection 55376 with 50598c and 55382.....
*21358	—	Feed Across Connection Cap (lower).....
1057E	5047	“ “ “ “ “ “ Screw.....
*55377	—	“ “ “ “ “ (upper).....
1057E	5047	“ “ “ “ “ “ Screw.....
18356	5045	“ “ “ “ “ Regulator with 1952.....
50598c	5047	“ “ “ “ “ Adjusting Ball Screw Stud.....
1676c	5047	Feed Across Regulator Adjusting Ball Screw Stud Nut.....
17738	5047	Feed Across Regulator Adjusting Ball Screw Stud Nut Washer.....
18357	5047	Feed Across Regulator Hinge Stud.....
690D	5047	“ “ “ “ “ “ Clamping Screw.....
1952	5047	Feed Across Regulator Roller and Stud.....
18358	5046	“ “ “ “ “ Shaft.....
18359	5047	“ “ “ “ “ Collar with two 200F.....
200F	5047	“ “ “ “ “ “ Set Screw.....
18421	5047	“ “ “ “ “ Crank (back) with 160E and 200c.....
55382	5047	Feed Across Shaft Crank (back) Ball Stud.....
200c	5047	“ “ “ “ “ “ “ Set Screw.....
160E	5047	Feed Across Shaft Crank (back) Clamping Screw.....

NO.	PLATE	NAME
18362	5007	Feed Across Shaft Crank (front) with 160E and 18363.....
160E	5047	Feed Across Shaft Crank (front) Clamping Screw.....
18363	5007	Feed Across Shaft Crank (front) Stud.....
18364	5007	“ “ “ “ “ “ Slide Block.....
55372	—	Feed Cam with 17874 and two each 190D and 1192c.....
39211	5045	Feed Cam Driving Worm with 1441c and 1442c.....
1442c	5021	Feed Cam Driving Worm Position Screw.....
1441c	5021	“ “ “ “ “ “ Set Screw.....
39212	5045	“ “ “ “ “ “ Wheel with 453c.....
3012	3722	Feed Cam Driving Worm Wheel Pin.....
453c	5007	“ “ “ “ “ “ Set Screw.....
18384	5007	“ “ “ “ “ Pin.....
1192c	3724	“ “ “ “ “ “ Set Screw.....
18416	5046	“ “ “ “ “ “ Shaft.....
18417	5049	“ “ “ “ “ “ Bracket.....
1177D	5047	“ “ “ “ “ “ Screw (back).....
1193D	3724	“ “ “ “ “ “ (front).....
1653c	3724	“ “ “ “ “ “ Nut.....
55373	8575	“ “ “ “ “ Plate.....
*18437	5046	“ “ “ “ “ “ Carrier Bar.....
55374	—	“ “ “ “ “ “ 18437 with 934J, 1195E, 1221c, 18366, 18390, 18488, two 55300 and four 17806.....
18366	5007	Feed Plate Carrier Bar Block.....
18367	5007	“ “ “ “ “ “ Cover.....
1221c	5007	“ “ “ “ “ “ Screw.....
55300	8576	“ “ “ “ “ “ Steady Pin.....
17805	5007	“ “ “ “ “ “ Pivot Block.....
1194D	5007	“ “ “ “ “ “ “ Screw.....
18390	5007	“ “ “ “ “ “ Plate.....
934J	5007	“ “ “ “ “ “ “ Screw.....
1654c	8576	“ “ “ “ “ “ Nut.....
17806	8576	“ “ “ “ “ “ Position Stud.....
1195E	8576	“ “ “ “ “ “ Screw Stud.....
39361	5048	“ “ “ “ “ “ Regulator with 1953.....
18469	5048	“ “ “ “ “ “ Bracket with 690D, 39310 and two 160D.....
55375	—	Feed Regulator Bracket 18469 with 18356, 18357, 39313 and 39361.....
*39310	—	Feed Regulator Bracket Cap.....
160D	5047	“ “ “ “ “ “ “ Screw.....

NO.	PLATE	NAME
8589	3722	Feed Regulator Bracket Dowel Pin.....
1177E	5047	" " " Screw.....
17744	5047	" " Hinge Stud.....
18488	3759	" " Post.....
18489	3759	" " " Guide.....
810J	3759	" " " " Cap Screw...
1953	5021	" " Roller and Screw Stud with 1655c and 14017.....
1655c	5021	Feed Regulator Roller and Screw Stud Nut
14017	5047	" " " " " " " " Washer.....
39313	3759	Feed Regulator Swivel.....
1191D	5047	" " " Thumb Screw.....
55319	8576	Knife (needle thread).....
55320	8576	" (shuttle thread).....
18370	5044	" Bar with 18373 and two 17822.....
55357	8576	" " Cap.....
219D	8576	" " " Screw.....
18372	5016	" " Connection with 17917.....
190D	5556	" " " " Screw.....
7071	8576	" " " " Washer.....
17915	5016	" " " Slide Block.....
17917	—	" " " " " " 17915 with 17916.....
17916	5016	Knife Bar Connection Slide Block Stud..
39297	5016	" " Driving Lever with 190D, 1420E, 17919 and 39298.....
1382F	5016	Knife Bar Driving Lever Hinge Screw...
1681c	5016	" " " " " " Nut
39298	5016	" " " " Lock Stud.....
17919	5016	" " " " " " Spring
190D	5556	" " " " " " " Screw.....
1420E	5016	Knife Bar Driving Lever Lock Stud Stop Screw.....
18373	8576	Knife Bar Rack.....
17822	8576	" " " Rivet.....
39235	5048	" Cam Lever Body.....
39409	—	" " " 39235 with 39460
39329	5048	Knife Cam Lever complete, Nos. 19793 and 39409.....
18470	5048	Knife Cam Lever Bracket with 1177D....
8589	3722	" " " " Dowel Pin....
670E	5021	" " " " Screw.....
50029c	3759	" " " Hinge Screw.....
18471	3759	" " " " " Bushing..

NO.	PLATE	NAME
*18472	—	Knife Cam Lever Hinge Screw Bushing 18471 with 50029c.....
1177D	5047	Knife Cam Lever Hinge Screw Bushing Clamping Screw.....
1980	3759	Knife Cam Lever Roller and Screw Stud with 1654c.....
1654c	8576	Knife Cam Lever Roller and Screw Stud Nut.....
39330	3759	Knife Cam Lever Slide with 1980.....
39460	—	" " " " 39330 with 1255D and 39331.....
1255D	5021	Knife Cam Lever Slide Screw.....
39331	3759	" " " " Washer....
19793	8576	" " " " Steady Pin.....
17825	8576	" Holder with 17826, 17830 and two 7298.....
55323	—	Knife Holder 17825 with 1198c, 17829, 55319 and 55320.....
17826	8576	Knife Holder Pinion.....
7298	8576	" " " Dowel Pin.....
17827	8576	" " " Stud.....
17828	8576	" " " " Bracket with 17827.....
50018F	5021	Knife Holder Pinion Stud Bracket Screw
1698c	5021	" " " " " " Nut.....
1198c	8576	Knife Screw.....
55321	8576	" (stationary).....
*55322	8576	" " Bracket.....
42639	8576	" " " Pin.....
50117J	8576	" " Screw.....
17829	8576	" Thread Holder.....
17830	8576	" " " Position Pin.....
17831	5046	Needle Bar with 237F.....
*39203	3718	" " Connecting Link.....
63756	—	" " " " 39203 with 21629.....
377c	3718	Needle Bar Connecting Link Hinge Screw
1518E	3718	" " " " " " Nut.....
21629	3718	Needle Bar Connecting Stud with 155c...
155c	3718	" " " " Set Screw..
39350	5045	" " Thread Nipper Driving Lever (adjustable) with 39351 and two 335D
39351	3759	Needle Bar Thread Nipper Driving Lever Extension.....

## PARTS FOR MACHINE No. 69-21

NO.	PLATE	NAME
335D	3759	Needle Bar Thread Nipper Driving Lever Extension Screw.....
1196C	3721	Needle Bar Thread Nipper Driving Lever Hinge Screw.....
39352	5045	Needle Bar Thread Nipper Driving Lever Spring.....
17834	3718	Needle Bar Thread Nipper Lever with 17835.....
17835	3718	Needle Bar Thread Nipper Lever Bushing
1200D	3718	" " " " " Hinge Screw.....
39276	8576	Needle Bar Thread Nipper Lever Spring
1329D	8576	" " " " " " Screw.....
17837	5045	Needle Bar Thread Nipper Rod.....
17838	3718	" " " " " Adjusting Stud.....
1651E	5021	Needle Bar Thread Nipper Rod Adjusting Stud Lock Nut.....
17839	3718	Needle Bar Thread Nipper Rod Arm with 196F.....
196F	3718	Needle Bar Thread Nipper Rod Arm Set Screw.....
17840	5001	Needle Bar Thread Nipper Rod Support
190D	5556	" " " " " " Screw.....
237F	3724	Needle Set Screw.....
*6022	5001	Oscillating Rock Shaft (steel) with 4784
55278	—	Oscillating Rock Shaft complete, Nos. 1513J, 6022 and 6489.....
6489	5001	Oscillating Rock Shaft Hinge Pin.....
1513J	3724	" " " " " Nut.....
4784	8576	" " " " Oil Pad.....
18385	5046	" Shaft.....
18386	—	" Crank.....
18387	5017	Oscillating Shaft Crank complete, Nos. 237F, 1519E, 15171 and 18386.....
2049	5017	Oscillating Shaft Crank Pin.....
237F	5017	" " " " Set Screw.....
15170	5017	" " " " Slide Block.....
229D	5017	" " " " " Cap Screw.....
12424	5017	Oscillating Shaft Crank Slide Block Cap Screw Washer.....
1035C	5017	Oscillating Shaft Crank Slide Block Screw Stud.....

## PARTS FOR MACHINE No. 69-21

NO.	PLATE	NAME
1519E	5017	Oscillating Shaft Crank Slide Block Screw Stud Nut.....
15171	5017	Oscillating Shaft Crank Slide Block complete, Nos. 229D, 1035C, 12424 and 15170
2058	5046	Presser Bar.....
17841	3718	" " Collar with two 196E.....
196F	3718	" " " Set Screw.....
17842	3718	" " Guide Bracket with 453C.....
453C	5007	" " " Set Screw.....
17843	5045	" " Lifting Lever.....
17844	5049	" " " " Bracket.....
164E	3724	" " " " " Screw.....
1201C	5021	" " " " Hinge Screw.....
17845	5046	" " " " Rod.....
17846	—	" " " " " Chain.....
8414	5001	" " Spring.....
17941	5049	Pulley (loose) 2 7/8 in. diam.....
17848	5049	" " Bushing.....
2269	3722	" " " Position Pin.....
1202D	3724	" " Cap Screw.....
17942	5049	" (tight) 2 7/8 in. diam., with 2269.....
2022	3722	" Pin.....
17955	—	Pulleys complete, Nos. 1202D, 1206C, 17848, 17854, 17941 and 17942.....
2996	5017	Shuttle Bobbin.....
15140	5017	" " Case Latch.....
2973	5017	" " " " Lever.....
2974	5017	" " " " " Fulcrum Pin.....
2975	5017	Shuttle Bobbin Case Latch Spring.....
592E	5017	" " " " Stop Screw.....
15141	—	" " " Hinge, Nos. 2973, 2974 and 15140.....
15027	5017	Shuttle Bobbin Case Position Finger.....
2523	5017	" " " " " Rivet.....
15277	5017	Shuttle Bobbin Case complete, Nos. 591F, 592E, 2523, 2975, 15027, 15141 and 15278.....
21562	5017	Shuttle Body.....
591F	5017	" Tension Regulating Screw.....
15278	5017	" " Spring.....
21561	5017	Shuttle, 1 1/4 in. diam., Nos. 2996, 15277 and 21562.....
*2542	—	Shuttle Driver.....
2441	5017	" " 2542 with two 462C.....
2049	5017	" " Pin.....
462C	5017	" " Set Screw.....

NO.	PLATE	NAME
55362	—	Shuttle Race Body.....
21623	8577	“ “ Cap.....
	662D	“ “ “ Screw.....
	2523	“ “ “ Steady Pin.....
55363	8577	“ “ Ring.....
18413	8577	“ “ “ Spring.....
	1289D	“ “ “ “ Screw.....
55364	8577	Shuttle Race (flexible) complete, Nos. 662D, 2523, 21623, 55362, 55363 and two each 1289D and 18413.....
	171D	8577 Shuttle Race Screw.....
17853	5048	Starting Lever.....
	1262C	5021 “ “ Hinge Screw.....
	1662C	5021 “ “ “ “ Nut.....
17886	5048	“ “ Pitman.....
17854	3721	Stop Cam.....
17855	3721	“ “ Interlocking Rod.....
55387	—	“ “ “ “ Case.....
18492	5049	“ “ “ “ “ 5 5 3 8 7 with 18443 and two 193D.....
55285	—	Stop Cam Interlocking Rod Case 18492 with 1318D, 17855, 17863, 17864, 39222, 39223 and two 1255D.....
39346	5049	Stop Cam Interlocking Rod Case Bracket
55304	—	Stop Cam Interlocking Rod Case Bracket complete, Nos. 1182E, 1196C, 1204E, 1254C, 1262C, 1508E, 1662C, 17853, 17859, 17861, 17862, 17872, 17873, 39346, 55285 and two 898D.....
18493	—	Stop Cam Interlocking Rod Case Bracket 55304 with 39343, 39344 and two 1186D
16532	3722	Stop Cam Interlocking Rod Case Bracket Dowel Pin.....
1343E	5021	Stop Cam Interlocking Rod Case Bracket Screw.....
1204E	3721	Stop Cam Interlocking Rod Case Hinge Screw.....
17859	5048	Stop Cam Interlocking Rod Case Socket Joint.....
	898D	3721 Stop Cam Interlocking Rod Case Socket Joint Cap Screw.....
39343	5049	Stop Cam Interlocking Rod Case Spring (flat).....
	430C	3759 Stop Cam Interlocking Rod Case Spring Adjusting Screw.....
	1520E	3759 Stop Cam Interlocking Rod Case Spring Adjusting Screw Nut.....

NO.	PLATE	NAME
39344	3759	Stop Cam Interlocking Rod Case Spring Bracket with 430C and 1520E.....
	1186D	5021 Stop Cam Interlocking Rod Case Spring Bracket Screw.....
17861	3721	Stop Cam Interlocking Rod Case Stop Stud.....
	1254C	5021 Stop Cam Interlocking Rod Case Stop Stud Screw Bushing.....
	1508E	5021 Stop Cam Interlocking Rod Case Stop Stud Screw Bushing Lock Nut.....
17862	3721	Stop Cam Interlocking Rod Case Stop Stud Spring.....
18443	5581	Stop Cam Interlocking Rod Case Wearing Block.....
	193D	5587 Stop Cam Interlocking Rod Case Wearing Block Screw.....
17863	3721	Stop Cam Interlocking Rod Spring.....
17864	3721	“ “ “ “ Stop.....
	1318D	5581 “ “ “ “ “ Screw..
	3012	3722 “ “ Pin.....
	1206C	3721 “ “ Screw.....
	2102	3722 Tension Disc.....
	1560C	3722 “ Regulating Thumb Nut.....
	600C	3722 “ Screw Stud.....
	448C	3722 “ “ Set Screw.....
	2103	3722 “ Spring.....
	2105	3722 “ Thread Guard.....
*55302	—	Thread Take-up Cam.....
	18392	5045 “ “ “ 55302 with 446C...
	3012	3722 “ “ “ Pin.....
	446C	3724 “ “ “ Set Screw.....
*18393	5049	“ “ “ Lever with 1822.....
55283	—	“ “ “ 18393 with 79C...
	79C	5021 “ “ “ Hinge Screw.....
	1822	5021 “ “ “ Roller and Stud..
	2124	3722 “ “ “ Spring.....
	2127	3722 “ “ “ Regulator Plate
	233D	3722 “ “ “ “ “
		Adjusting Screw.....
17865	7229	Thread Wiper Body.....
	1207D	7229 “ “ “ Hinge Screw.....
17866	7229	“ “ “ Hook.....
17867	7229	“ “ “ Support.....
	641C	5021 “ “ “ “ Set Screw...
17868	7229	“ “ “ Wire.....
	337D	3718 “ “ “ “ Screw.....
17869	7229	“ “ “ “ “ Washer..

NO.	PLATE	NAME
55366	—	Throat Plate with 55322 and two 42639
55367	8578	" " 55366 with 55326 and two 1208D.....
55326	8578	Throat Plate Needle Hole Bushing.....
1208D	8578	" " " " " Screw
55368	—	Throat Plate complete, Nos. 1698c, 17828, 50018F, 50117J, 55321, 55323 and 55367
691F	3724	Throat Plate Screw.....
17872	3721	Trip Lever.....
1196c	3721	" " Hinge Screw.....
17873	3721	" " Spring.....
1182E	8576	" " " Screw.....
17874	7229	Tripping Point.....
190D	5556	" " Screw.....

## LIST OF PARTS COMPLETE

FOR

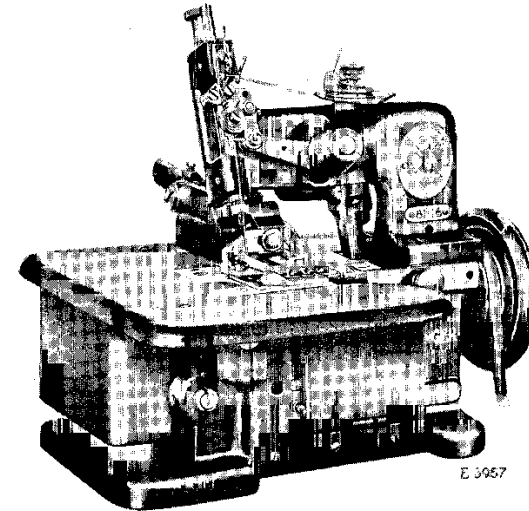

## MACHINE No. 81-16

FOR MAKING THE STEM OF THE CLOCKING ON HEAVY WOOLEN OR FINE SILK HOSIERY WITH LADDER OR IMITATION HAND STITCH WHERE MATERIAL IS REVERSED, OR WITH ORNAMENTAL OVEREDGE STITCH IF SEWED ON THE OUTSIDE. A LARGE VARIETY OF ATTRACTIVE EFFECTS MAY BE OBTAINED BY USING DIFFERENT COLORED THREAD IN THE NEEDLE AND LOOPER AND BY ADJUSTING THE TENSIONS. NO TRIMMER. TWO THREAD STITCH. FOOT LIFTER.

NO.	PLATE	NAME
*42251	—	Arm with two each 462c and 42253.....
4389	8581	" Dowel Pin.....
949E	5587	" Screw.....
42001	5576	Balance Wheel, 2 $\frac{3}{8}$ in. pulley, with 424c and 1354c.....

NO.	PLATE	NAME
1354c	5587	Balance Wheel Position Screw.....
424c	5587	" " Set Screw.....
42002	5526	Cloth Plate.....
42107	—	Cloth Plate complete, Nos. 42002, 42003, 42005, 42108, two 236D and five 229E
42003	5526	Cloth Plate Extension (lower).....
229E	5587	" " " " Screw.....
42108	5526	" " " (upper).....
229E	5587	" " " " Screw.....
1437D	5587	" " Hinge Screw.....
1655E	5587	" " " " Nut.....
42005	5526	" " Lock Spring.....
236D	5587	" " " " Screw.....
42205	5588	Feed Bar with 1253c.....
42007	5529	" " Hinge Pin.....
1253c	5529	" " " " Set Screw.....
42008	5529	" Connecting Rod with 42009 and two 1057E.....
*42009	—	Feed Connecting Rod Cap.....
1057E	5529	" " " " Screw.....
1373c	5529	" " " " Hinge Screw.....
1520c	5529	" " " " Nut..
42422	7395	" Dog.....
190D	5556	" " Screw.....
42011	5529	" Eccentric with two 453c.....
42094	5526	" " Cover.....
42102	7394	" " " " Holder.....
283D	7394	" " " " T h u m b Screw.....
2749	7394	Feed Eccentric Cover Holder Thumb Screw Washer.....
207F	5529	Feed Eccentric Cover Screw.....
453c	5529	" " Set Screw.....
42012	5529	" Lifting Eccentric with two 462c....
42013	5529	" " " " Connection.....
462c	5529	" " " " Set Screw.....
1374c	5530	" Regulating Screw Stud.....
1680c	5530	" " " " Nut.....
42290	5530	" " " " Washer.....
42014	5530	" Regulator with 233D and two 1259c.
42015	5529	" " Connection with 1012E...
1012E	5529	" " " " A d j u s t i n g Screw.....
1373c	5529	Feed Regulator Connection Hinge Screw
1520c	5529	" " " " " "
		Nut.....

NO.	PLATE	NAME
42016	5530	Feed Regulator Hinge Stud.....
42017	5529	" " Indicator.....
42018	5530	" " " " Plate.....
337D	5530	" " " " " " Screw....
207F	5529	" " " " " " Screw.....
1259c	5530	" " " " Set Screw.....
233D	5530	" " " " Stop Screw.....
42019	5530	" Rock Shaft.....
42020	—	Feed Rock Shaft complete, Nos. 42019 and 42021.....
42021	5530	Feed Rock Shaft Crank with 157E.....
157E	5530	" " " " " " Clamping Screw.
42098	5530	" " " " Hinge Pin.....
42079	5530	" " " " " " Bushing.....
1036c	5530	" " " " " " " " S e t Screw.....
*42022	—	Frame.....
42023	5576	" Rotary Shaft.....
42024	5576	" " " " Bushing (front).....
1036c	5530	" " " " " " " " S e t Screw.....
42025	5553	Frame Rotary Shaft Crank with 1259c and 1375c.....
1375c	5553	Frame Rotary Shaft Crank Position Screw
1259c	5553	" " " " " " Set Screw....
42026	5576	" " " " Flanged Bushing (back).....
54967	7394	Frame Rotary Shaft Flanged Bushing (back) Oil Pad (braided cotton).....
1036c	5553	Frame Rotary Shaft Flanged Bushing (back) Set Screw.....
42367	7394	Frame Rotary Shaft Front Bearing Oil Pad (braided cotton).....
42193	5588	Frame Side Cover (left) with 19045.....
19045	7394	" " " " " " Handle.....
330D	5587	" " " " " " Screw.....
42028	5526	" " " " (right) hinged.....
42192	7394	" " " " " " Lock Spring....
330D	5587	" " " " " " " " Screw
330D	5587	" " " " " " " " Screw.....
42029	5576	" Top Cover.....
742F	5587	" " " " " " Screw.....
42423	7394	Guide.....
217F	5556	" Screw.....
7071	8576	" " Washer.....
42050	5553	Looper (left hand).....
42051	5553	" " " " " " Lever with 209H.....

NO.	PLATE	NAME
42052	5553	Looper (left hand) Lever Connecting Link
50562c	7394	" " " " " "
		Hinge Screw.....
1520c	5553	Looper (left hand) Lever Connecting Link
		Hinge Screw Nut.....
42053	5553	Looper (left hand) Lever Hinge Stud.....
1036c	5553	" " " " " " Set
		Screw.....
209H	5553	Looper (left hand) Set Screw.....
42166	5553	" (right hand).....
42073	5553	" " " and Spreader Lever
		with 1259c.....
42074	5553	Looper (right hand) and Spreader Lever
		Ball Stud.....
1259c	5553	Looper (right hand) and Spreader Lever
		Ball Stud Set Screw.....
42075	5553	Looper (right hand) and Spreader Lever
		Connection with 42059, 42076 and four
		896E.....
*42076	—	Looper (right hand) and Spreader Lever
		Connection Cap (lower).....
896E	7394	Looper (right hand) and Spreader Lever
		Connection Cap (lower) Screw.....
*42059	—	Looper (right hand) and Spreader Lever
		Connection Cap (upper).....
896E	7394	Looper (right hand) and Spreader Lever
		Connection Cap (upper) Screw.....
42077	7394	Looper (right hand) and Spreader Lever
		Connection Guide.....
171F	5544	Looper (right hand) and Spreader Lever
		Connection Guide Screw.....
42106	7394	Looper (right hand) and Spreader Lever
		Connection Oil Tube and Bracket with
		29599.....
29599	7394	Looper (right hand) and Spreader Lever
		Connection Oil Tube Packing (felt)...
42078	7394	Looper (right hand) and Spreader Lever
		Hinge Pin.....
42079	5530	Looper (right hand) and Spreader Lever
		Hinge Pin Bushing.....
1259c	5530	Looper (right hand) and Spreader Lever
		Hinge Pin Bushing Set Screw.....
197D	5553	Looper (right hand) Screw.....
42054	5544	Needle Bar.....
42253	5544	" " Bushing.....
462c	5544	" " " Set Screw.....

NO.	PLATE	NAME
42061	5544	Needle Bar Connecting Bracket with 187D
		and 223F.....
187D	5544	Needle Bar Connecting Bracket Clamping
		Screw.....
42055	5544	Needle Bar Connecting Link.....
40247	5544	" " " " " Hinge Pin ..
223F	5544	" " " " " " Set
		Screw for 42061.....
904c	5544	Needle Bar Connecting Link Hinge Pin
		Set Screw for 42104.....
42057	5544	Needle Bar Connecting Rod with 42059,
		42076 and four 896E.....
*42076	—	Needle Bar Connecting Rod Cap (lower)
		" " " " " " "
896E	7394	" " " " " " "
		Screw.....
*42059	—	Needle Bar Connecting Rod Cap (upper)
		" " " " " " "
896E	7394	" " " " " " "
		Screw.....
42077	7394	Needle Bar Connecting Rod Guide ..
171F	5544	" " " " " " Screw
42103	5544	Needle Bar Crank (back) with 1258c and
		two 1259c.....
42074	5553	Needle Bar Crank (back) Ball Stud.....
1259c	5553	" " " " " " Set
		Screw.....
1259c	5553	Needle Bar Crank (back) Position Screw.
1258c	5544	" " " " " Set Screw.....
42104	5544	" " " (front) with 904c,
		1258c and 1259c.....
1259c	5553	Needle Bar Crank (front) Position Screw.
1258c	5544	" " " " " Set Screw.....
42105	5544	" " " Shaft.....
42115	5544	" " Thread Retainer Bracket.....
10106	5544	" " " " " Disc.....
93c	5544	" " " " " Screw.....
10107	5544	" " " " " Spring.....
1728c	7394	" Clamping Nut.....
42066	5544	" Guard.....
42195	5588	" " Holder.....
1101c	5587	" " " Screw.....
171F	5544	" " " Screw.....
2532	7394	Presser Foot Hinge Pin.....
42424	—	" " " Plate.....
42425	—	" " Shank.....
42426	7395	Presser Foot (hinged) complete, Nos. 2532,
		42424 and 42425.....



NO.	PLATE	NAME
1324c	5545	Presser Foot Screw.....
39541	5545	“ “ “ Washer.....
42069	5545	“ Lever.....
42045	5545	“ “ Hinge Stud.....
1120c	5545	“ “ “ “ Set Screw.....
42070	5545	“ “ Lifter.....
85D	5545	“ “ Hinge Screw.....
1377c	5545	“ “ Screw Stud (eccentric).....
1547D	5545	“ “ “ “ Nut.....
42071	5545	“ “ Spring.....
1378D	5545	Pressure Regulating Thumb Screw.....
42427	7395	Spreader.....
197D	5556	“ Screw.....
2102	5556	Tension (looper, left hand) Disc.....
1560c	5556	“ “ “ “ Regulating Thumb Nut.....
828c	5556	Tension (looper, left hand) Screw Stud.....
42121	5556	“ “ “ “ Spring.....
2102	5556	“ (looper, right hand) Disc.....
1560c	5556	“ “ “ “ Regulating Thumb Nut.....
828c	5556	Tension (looper, right hand) Screw Stud.....
10148	5556	“ “ “ “ Spring.....
17547	5556	“ “ “ “ Thread Guide.....
2102	5556	“ (needle thread) Disc.....
1560c	5556	“ “ “ “ Regulating Thumb Nut.....
916c	5556	Tension (needle thread) Screw Stud.....
8238	5556	“ “ “ “ Spring.....
42082	5556	“ “ “ “ Thread Guide.....
42242	7394	Thread (looper, left hand) Eyelet.....
233D	5553	“ “ “ “ “ Screw..
42084	5556	“ “ “ “ “ Tube.....
462c	5556	“ “ “ “ “ Set Screw.....
42126	7394	“ (looper, right hand) Pull-off.....
42093	5556	“ “ “ “ “ Staple.....
190D	5556	“ “ “ “ “ Screw.....
42127	5556	“ “ “ “ “ Take-up.....
197F	5556	“ “ “ “ “ Screw.....
42428	7395	“ (needle) Eyelet (double).....
217F	5556	“ “ “ “ “ Screw.....
7071	8576	“ “ “ “ “ “ Washer.....
42429	7395	Thread (needle) Controller.....
206D	7394	“ “ “ “ “ Screw.....
42430	7395	Throat Plate.....
42431	7395	“ “ Chaining-off Finger.....

NO.	PLATE	NAME
42432	7395	Throat Plate Chaining-off Finger for purl stitch.....
50169D	7395	Throat Plate Chaining-off Finger Screw..
42433	—	Throat Plate complete for 42422, Nos. 42430, 42431 and two 50169D.....
742F	5587	Throat Plate Screw.....

## IRON BASE

### FOR 81-16 MACHINE

NO.	PLATE	NAME
42086	5564	Machine Base with three wood screws 1¼ in. No. 12 and four each 935D, 4718 and 42088.....
4718	5586	Machine Base Cushion (felt).....
42088	5586	“ Cushion (felt).....
935D	5586	“ “ “ Screw.....

## ACCESSORIES

### FOR 81-16 MACHINE

NO.	PLATE	NAME
1407E	5563	Machine Base Thumb Screw, for 3 in. table
1408E	5563	“ “ “ “ “ 2 in. table
14063	5586	“ “ “ “ “ Spring.....
9842	5586	“ “ “ “ “ Washer
120344	5566	Oiler (copper plated) with 120345.....
120345	5566	“ Spout, 5 in. long.....
26151	5566	Screw Driver.....
42090	5566	Threading Wire.....
120341	5566	Tweezers (curved).....
42089	5566	Wrench for 1324, 1374 and 1728.....
8908	5566	“ “ 1520 and 1655.....
4822	5566	“ “ 1547.....

## ATTACHMENTS AND ACCESSORIES

### FOR 69-20 AND 69-21 MACHINES

NO.	PLATE	NAME
18419	—	Cylinder Base Plate with two 453c.....
18420	8580	“ “ “ “ Hinge Connection...
18423	8580	“ “ “ “ “ Hinge Pin.....

NO.	PLATE	NAME
453c	5007	Cylinder Base Plate Hinge Connection Hinge Pin Set Screw.....
18424	5044	Cylinder Base Plate (hinged) complete, Nos. 18419, two each 18420, 18423, three wood screws 1¼ in. No. 12 and four 134d.....
134d	8580	Cylinder Base Plate Screw.....
41400	5023	Machine Rest Pin (wood).....
120346	4079	Oiler (copper plated) with 120347.....
120347	4079	" Spout, 9 in. long.....
11831	5023	Screw Driver (large).....
26026	5023	" " (machine).....
26485	5023	" " (shuttle tension).....
10875	5023	Wrench for 1518 and 1520.....
27662	5023	" " 1508.....
17905	5023	" " 1654 and 1676.....
22003	5023	" " 1651.....

## BOBBIN WINDER

(SWINGING AUTOMATIC, LEFT HAND)

FOR 69-20 AND 69-21 MACHINES

NO.	PLATE	NAME
41598	8579	Base with 27916 and two 28084.....
1186c	5021	" Screw.....
15072	8576	Bobbin Position Pin.....
41715	5023	Bracket.....
129E	8580	" Screw.....
27916	5016	Brake (leather).....
28084	5016	" Rivet.....
27321	8579	Frame.....
50356D	8580	" Hinge Screw.....
1620J	8580	" " " Nut.....
41825	8580	" Spring.....
41600	8579	Pulley with 155c.....
155c	8580	" Set Screw.....
*27849	—	Spindle.....
27538	8579	" 27849 with 15072, 27850 and 41828.....
*27850	—	Spindle Collar.....
41828	8580	" " Pin.....
27328	8579	Stop Latch.....
35D	3724	" " Hinge Screw.....
60769	8579	Tension Bracket.....

## BOBBIN WINDER

NO.	PLATE	NAME
60770	8579	Tension Bracket complete, Nos. 419E, 1562J, 8422, 9780, 43808, 60769 and two 2455.....
9780	8580	Tension Bracket Position Stud.....
161D	3724	" " Screw.....
2455	8580	" Disc.....
1562J	8580	" Regulating Thumb Nut.....
419E	8580	" Screw Stud.....
43808	8580	" Spring.....
8422	8580	" Thread Guide.....
41604	8579	Bobbin Winder, Nos. 35D, 1620J, 27321, 27328, 27538, 41598, 41600, 41825 and 50356D.....
41716	—	Bobbin Winder (swinging automatic, left hand) complete, Nos. 161D, 41604, 60770 and two 1186c.....

## FOOT LIFTER PARTS

FOR 81-16 MACHINE

NO.	PLATE	NAME
6439	—	Chain, 36 in. to 45 in., with 56864 and 56865.....

NOTE: When ordering No. 6439 give length required.

4879	5566	Chain Connecting Link.....
56864	5566	" Hook (large).....
56865	7229	" " (small).....
42130	5586	Lifting Lever.....
42131	5586	" " Bracket.....
1229c	5586	" " " Screw.....
1301D	5586	" " Hinge Screw.....
42132	5586	" " Spring.....
1148F	5586	" " Stop Screw.....
1547D	5545	" " " " Nut.....
4881	5564	Treadle.....
4882	5566	" Shaft.....
4883	5566	" Spring.....
4884	5564	" Stand.....
4885	5564	Treadle complete, Nos. 4879, 4881 to 4884 and two wood screws 1 in. No. 16.....
42133	—	Foot Lifter complete, Nos. 1301D, 4885, 6439, 42130 to 42132 and two each 1148F, 1229c and 1547D.....

## KNEE LIFTER PARTS

FOR 81-16 MACHINE

NO.	PLATE	NAME
42130	5586	Lifting Lever.....
42131	5586	" " Bracket.....
1229c	5586	" " " " Screw.....
42142	5564	" " Connecting Rod.....
1301D	5586	" " Hinge Screw.....
42132	5586	" " Spring.....
1148F	5586	" " Stop Screw.....
1547D	5545	" " " " Nut.....
2763	5564	Rock Shaft.....
12242	5564	" " Hanger with two wood screws 1 in. No. 10.....
2765	5564	Rock Shaft Knee Arm.....
2766	5564	" " " " Hub with 356c....
356c	5587	" " " " " " Set Screw....
2768	—	Rock Shaft Knee Arm complete, Nos. 2765 to 2767.....
2767	5564	Rock Shaft Knee Plate with 356c.....
356c	5587	" " " " " " Set Screw.....
6337	5564	" " Lifting Bracket with two 356c.....
7125	5564	" " " " " " Hook.....
356c	5587	" " " " " " Set Screw.....
356c	5587	" " " " " " Set Screw....
2770	5564	" " Stop Dog with 356c.....
356c	5587	" " " " " " Set Screw.....
42143	5564	Rock Shaft complete, Nos. 2763, 2768, 6337, 7125 and two each 2770 and 12242
42144	—	Knee Lifter complete, Nos. 1301D, 42130 to 42132, 42142, 42143 and two each 1148F, 1229c and 1547D.....

## PROTECTOR

FOR 69-20 AND 69-21 MACHINES

NO.	PLATE	NAME
39489	7008	Arm with 39490.....
160c	7009	" Clamping Screw.....
39490	—	Blade.....
39491	7008	Bracket with two each 426c and 448c....
426c	7009	" Adjusting Screw.....
50351D	7009	" Screw.....
39492	7009	Crank with 160c.....
39493	7009	" Bracket with 1120c and two 454c

NO.	PLATE	NAME
454c	7009	Crank Bracket Set Screw.....
52598	7009	" Hinge Stud.....
1120c	7009	" " " " Set Screw.....
39494	7008	Rod.....
15261	7009	" Collar with 237F.....
237F	7009	" " Set Screw.....
39495	7009	" Connection.....
176D	7009	" " " " Screw.....
1099F	7009	" Screw Stud.....
39496	7008	" Sleeve.....
448c	7009	" " Set Screw.....
39497	7009	" Spring.....
15261	7009	" " Collar with 237F.....
237F	7009	" " " " Set Screw.....
63753	—	Protector (front of needle) Nos. 1099F, 39489, 39491 to 39494, 39496, 39497, 52598 and two 15261.....
39498	—	Protector (front of needle) complete, Nos. 39495, 63753 and two each 176D and 50351D.....

## STAND FOR ELECTRIC MOTOR

FOR 69-20 AND 69-21 MACHINES

NO.	PLATE	NAME
25490	—	Belt, size ¼ in., length 36 in., with 25127
25127	7229	" Hook.....
46667	7219	Brace.....
748E	8580	" Screw.....
46522	7219	Leg.....
4881	7219	Motor Treadle.....
46614	7219	" " Bracket (left).....
1177E	5047	" " " " " " Screw.....
46615	7219	" " " " (right).....
1177E	5047	" " " " " " Screw....
4879	5023	" " Chain Connecting Link...
4882	5023	" " Shaft.....
4883	5023	" " Spring.....
46616	7219	Motor Treadle complete, Nos. 4879, 4881 to 4883, 46614 and 46615.....
4881	7219	Starting Treadle.....
46614	7219	" " Bracket (left).....
1177E	5047	" " " " " " Screw....
46615	7219	" " " " (right).....
1177E	5047	" " " " " " Screw...

## THREAD UNWINDERS

NO.	PLATE	NAME
200383c	7229	Spool Rest Rod Set Screw.....
201018c	7229	" " Set Screw.....
202490	7165	" Stand with 200383c.....
60913	7165	" Weight with 60914.....
60914	7229	" Centre Pin.....
225391	7165	Thread Guide.....
201696J	7229	" " Lock Nut.....
225392	7165	" " Rod with 208E and 225393
208E	5587	" " Screw.....
225393	7229	" " Washer.....
225397	7165	Thread Unwinder complete, Nos. 201696J, 202490, 225388, 225389, 225392, 225395, three each 60913, 225391 and three wood screws 7/8 in. No. 13.....
27739	7234	Thread Cone (wood) for large cones.....
225390	7234	" " Holder, for inverted cones..

NOTE: Nos. 27739 and 225390 are used with,  
but not included in, 225397.

## OBSOLETE PARTS

## FOR 69-20 AND 69-21 MACHINES

NO.	PLATE	NAME
18353	5045	Feed Across Connection with 18354 and two 175E.....
*18354	—	Feed Across Connection Cap.....
175E	5021	" " " " Screw.....
18355	8580	" " Knuckle Joint.....
1184c	8581	" " " " Hinge Screw.
1187E	8580	" " Regulator Adjusting Stud
17739	8580	" " " " " "
		Sleeve.....
18422	5047	Feed Across Shaft Crank (back) Ball Stud

## NUMERICAL LIST OF PARTS

NO.	PLATE	NAME
35D	3724	Bobbin Winder Stop Latch Hinge Screw for 41604.....
79c	5021	Thread Take-up Lever Hinge Screw for 55283.....
85D	5545	Presser Lever Lifter Hinge Screw for 81-16 Machine.....
93c	5544	Needle Bar Thread Retainer Screw for 81-16 Machine.....
129E	8580	Bobbin Winder Bracket Screw for 41716
134D	8580	Cylinder Base Plate Screw for 18424....
153E	3724	Table Belt Guide Pulley Shaft Set Screw for 17892.....
155c	8580	Bobbin Winder Pulley Set Screw for 41600
155c	3718	Needle Bar Connecting Stud Set Screw for 21629.....
157E	5530	Feed Rock Shaft Crank Clamping Screw for 42021.....
158E	3724	Crank Connecting Rod Cap Screw for 4292
160E	5047	Feed Across Shaft Crank (back) Clamp- ing Screw for 18421.....
160E	5047	Feed Across Shaft Crank (front) Clamp- ing Screw for 18362.....
160D	5047	Feed Regulator Bracket Cap Screw for 18469 and 55353.....
160c	7009	Protector Arm Clamping Screw for 39492
161D	3724	Bobbin Winder Tension Bracket Screw for 41716.....
161D	3724	Treadle Pitman Rod Clamp Screw for 17879.....
164D	3724	Face Plate Screw for 69-20 and 69-21 Machines.....
164E	3724	Presser Bar Lifting Lever Bracket Screw for 18439.....
168E	5021	Table Belt Guide Belt Guide Set Screw for 39218.....
171F	5544	Looper (right hand) and Spreader Lever Connection Guide Screw for 81-16 Machine.....
171F	5544	Needle Bar Connecting Rod Guide Screw for 81-16 Machine.....
171F	5544	Needle Guard Screw for 81-16 Machine..
171D	8577	Shuttle Race Screw for 69-20 and 69-21 Machines.....

NO. PLATE	NAME
175E 5021	Feed Across Connection Cap Screw for 18353, obsolete.....
176D 7009	Protector Rod Connection Screw for 39498
181D 5021	Arch Clamp Frame Screw for 55345 and 55371.....
184E 5021	Belt Cover Bracket Screw Stud for 39290
187D 5544	Needle Bar Connecting Bracket Clamping Screw for 42061.....
190D 5556	Arch Clamp Foot Lifter Screw for 69-20 and 69-21 Machines.....
190D 5556	Feed Dog Screw for 81-16 Machine.....
190D 5556	Knife Bar Connection Screw for 69-20 and 69-21 Machines.....
190D 5556	Knife Bar Driving Lever Lock Stud Spring Screw for 39297.....
190D 5556	Needle Bar Thread Nipper Rod Support Screw for 69-20 and 69-21 Machines..
190D 5556	Thread (looper, right hand) Staple Screw for 81-16 Machine.....
190D 5556	Tripping Point Screw for 18410 and 55372
193D 5587	Stop Cam Interlocking Rod Case Wearing Block Screw for 18492.....
196F 3718	Needle Bar Thread Nipper Rod Arm Set Screw for 17839.....
196F 3718	Presser Bar Collar Set Screw for 17841...
197D 5553	Looper (right hand) Screw for 81-16 Machine.....
197D 5556	Spreader Screw for 81-16 Machine.....
197F 5556	Thread (looper, right hand) Take-up Screw for 81-16 Machine.....
200F 5047	Feed Across Shaft Collar Set Screw for 18359.....
200C 5047	Feed Across Shaft Crank (back) Ball Stud Set Screw for 18421.....
206D 7394	Thread (needle) Controller Screw for 81-16 Machine.....
207F 5529	Feed Eccentric Cover Screw for 81-16 Machine.....
207F 5529	Feed Regulator Indicator Screw for 81-16 Machine.....
208E 5587	Thread Unwinder Thread Guide Rod Screw for 225392.....
209H 5553	Looper (left hand) Set Screw for 42051...
217J 5556	Arch Clamp Foot Plate Screw for 55345 and 55371.....
217J 5556	Arch Clamp Foot Spring Screw (lower) for 55345 and 55371.....

NO. PLATE	NAME
217D 5556	Belt Cover Screw for 69-20 and 69-21 Machines.....
217F 5556	Guide Screw for 81-16 Machine.....
217F 5556	Thread (needle) Eyelet (double) Screw for 81-16 Machine.....
219D 8576	Knife Bar Cap Screw for 69-20 and 69-21 Machines.....
223F 5544	Needle Bar Connecting Link Hinge Pin Set Screw for 42061.....
229E 5587	Cloth Plate Extension (lower) Screw for 42107.....
229E 5587	Cloth Plate Extension (upper) Screw for 42107.....
229D 5017	Oscillating Shaft Crank Slide Block Cap Screw for 15171.....
233D 3722	Face Plate Thread Guard Screw for 17725
233D 5530	Feed Regulator Stop Screw for 42014....
233D 5553	Thread (looper, left hand) Eyelet Screw for 81-16 Machine.....
233D 3722	Thread Take-up Spring Regulator Plate Adjusting Screw for 17725.....
236D 5587	Cloth Plate Lock Spring Screw for 42107
237F 3724	Needle Set Screw for 17831.....
237F 5017	Oscillating Shaft Crank Set Screw for 18387.....
237F 7009	Protector Rod Collar Set Screw for 15261
237F 7009	" " Spring Collar Set Screw for 15261.....
283D 7394	Feed Eccentric Cover Holder Thumb Screw for 81-16 Machine.....
330D 5587	Frame Side Cover (left) Screw for 81-16 Machine.....
330D 5587	Frame Side Cover (right) Lock Spring Screw for 81-16 Machine.....
330D 5587	Frame Side Cover (right) Screw for 81-16 Machine.....
335D 3759	Needle Bar Thread Nipper Driving Lever Extension Screw for 39350.....
337D 5530	Feed Regulator Indicator Plate Screw for 81-16 Machine.....
337D 3718	Thread Wiper Body Wire Screw for 69-20 and 69-21 Machines.....
356C 5587	Rock Shaft Knee Arm Hub Set Screw for 2766.....
356C 5587	Rock Shaft Knee Plate Set Screw for 2767
356C 5587	" " Lifting Bracket Hook Set Screw for 6337.....

## NUMERICAL LIST OF PARTS

NO.	PLATE	NAME
356c	5587	Rock Shaft Lifting Bracket Set Screw for 6337.....
356c	5587	Rock Shaft Stop Dog Set Screw for 2770
375c	3724	Crank Connecting Rod Hinge Screw for 69-20 and 69-21 Machines.....
377c	3718	Needle Bar Connecting Link Hinge Screw for 69-20 and 69-21 Machines.....
419E	8580	Bobbin Winder Tension Screw Stud for 60770.....
424c	5587	Balance Wheel Set Screw for 42001.....
426c	7009	Protector Bracket Adjusting Screw for 39491.....
430c	3759	Stop Cam Interlocking Rod Case Spring Adjusting Screw for 39344.....
443c	8576	Treadle Shaft Set Screw for 17876.....
446c	3724	Thread Take-up Cam Set Screw for 18392
448c	7009	Protector Rod Sleeve Set Screw for 39491
448c	3722	Tension Screw Stud Set Screw for 17725
453c	5007	Cylinder Base Plate Hinge Connection Hinge Pin Set Screw for 18419.....
453c	5007	Feed Cam Driving Worm Wheel Set Screw for 17797 and 39212.....
453c	5529	Feed Eccentric Set Screw for 42011.....
453c	5007	Presser Bar Guide Bracket Set Screw for 17842.....
454c	7009	Protector Crank Bracket Set Screw for 39493.....
462c	5529	Feed Lifting Eccentric Set Screw for 42012
462c	5544	Needle Bar Bushing Set Screw for 42251
462c	5017	Shuttle Driver Set Screw for 2441.....
462c	5556	Thread (looper, left hand) Tube Set Screw for 81-16 Machine.....
591F	5017	Shuttle Tension Regulating Screw for 15277 and 55359.....
592E	5017	Shuttle Bobbin Case Latch Stop Screw for 15277 and 55359.....
600c	3722	Tension Screw Stud for 17725.....
641c	5021	Thread Wiper Body Support Set Screw for 69-20 and 69-21 Machines.....
662D	8577	Shuttle Race Cap Screw for 55364.....
670E	5021	Knife Cam Lever Bracket Screw for 69-20 and 69-21 Machines.....
690D	5047	Feed Across Regulator Hinge Stud Clamping Screw for 18469 and 55353.....
691F	3724	Throat Plate Screw for 69-20 and 69-21 Machines.....
742F	5587	Frame Top Cover Screw for 81-16 Machine

## NUMERICAL LIST OF PARTS

NO.	PLATE	NAME
742F	5587	Throat Plate Screw for 81-16 Machine..
748E	8580	Brace Screw for 25285.....
780E	8580	Treadle Support Bolt with 1600E for 25285
810J	3759	Feed Regulator Post Guide Cap Screw for 55345 and 55371.....
828c	5556	Tension (looper, left hand) Screw Stud for 81-16 Machine.....
828c	5556	Tension (looper, right hand) Screw Stud for 81-16 Machine.....
880E	3724	Arm Screw for 69-20 and 69-21 Machines
896E	7394	Looper (right hand) and Spreader Lever Connection Cap (lower) Screw for 42075
896E	7394	Looper (right hand) and Spreader Lever Connection Cap (upper) Screw for 42075
896E	7394	Needle Bar Connecting Rod Cap (lower) Screw for 42057.....
896E	7394	Needle Bar Connecting Rod Cap (upper) Screw for 42057.....
898D	3721	Stop Cam Interlocking Rod Case Socket Joint Cap Screw for 55304.....
904c	5544	Needle Bar Connecting Link Hinge Pin Set Screw for 42104.....
916c	5556	Tension (needle thread) Screw Stud for 81-16 Machine.....
934J	5007	Feed Plate Carrier Bar Plate Screw for 55349 and 55374.....
935D	5586	Machine Cushion Screw for 42086.....
949E	5587	Arm Screw for 81-16 Machine.....
1012E	5529	Feed Regulator Connection Adjusting Screw for 42015.....
1035c	5017	Oscillating Shaft Crank Slide Block Screw Stud for 15171.....
1036c	5530	Feed Rock Shaft Hinge Pin Bushing Set Screw for 81-16 Machine.....
1036c	5530	Frame Rotary Shaft Bushing (front) Set Screw for 81-16 Machine.....
1036c	5553	Frame Rotary Shaft Flanged Bushing (back) Set Screw for 81-16 Machine..
1036c	5553	Looper (left hand) Lever Hinge Stud Set Screw for 81-16 Machine.....
1057E	5047	Feed Across Connection Cap (lower) Screw for 55376.....
1057E	5047	Feed Across Connection Cap (upper) Screw for 55376.....
1057E	5529	Feed Connecting Rod Cap Screw for 42008
1099F	7009	Protector Rod Screw Stud for 63753....

NO.	PLATE	NAME
1329D	8576	Needle Bar Thread Nipper Lever Spring Screw for 69-20 and 69-21 Machines..
1343E	5021	Stop Cam Interlocking Rod Case Bracket Screw for 69-20 and 69-21 Machines..
1354c	5587	Balance Wheel Position Screw for 42001
1373c	5529	Feed Connecting Rod Hinge Screw for 81-16 Machine.....
1373c	5529	Feed Regulator Connection Hinge Screw for 81-16 Machine.....
1374c	5530	Feed Regulating Screw Stud for 81-16 Machine.....
1375c	5553	Frame Rotary Shaft Crank Position Screw for 42025.....
1377c	5545	Presser Lever Screw Stud (eccentric) for 81-16 Machine.....
1378D	5545	Pressure Regulating Thumb Screw for 81-16 Machine.....
1382F	5016	Knife Bar Driving Lever Hinge Screw for 69-20 and 69-21 Machines.....
1407E	5563	Machine Base Thumb Screw, for 3 in. table (Accessories).....
1408E	5563	Machine Base Thumb Screw, for 2 in. table (Accessories).....
1420E	5016	Knife Bar Driving Lever Lock Stud Stop Screw for 39297.....
1437D	5587	Cloth Plate Hinge Screw for 81-16 Machine.....
1441c	5021	Feed Cam Driving Worm Set Screw for 18415 and 39211.....
1442c	5021	Feed Cam Driving Worm Position Screw for 18415 and 39211.....
1508E	5021	Stop Cam Interlocking Rod Case Stop Stud Screw Bushing Lock Nut for 55304
1513J	3724	Oscillating Rock Shaft Hinge Pin Nut for 55278.....
1518E	3718	Crank Connecting Rod Hinge Screw Nut for 69-20 and 69-21 Machines.....
1518E	3718	Needle Bar Connecting Link Hinge Screw Nut for 69-20 and 69-21 Machines.....
1519E	5017	Oscillating Shaft Crank Slide Block Screw Stud Nut for 18387.....
1520E	3724	Arm Shaft Bushing (back) Adjusting Screw Nut for 69-20 and 69-21 Machines
1520c	5529	Feed Connecting Rod Hinge Screw Nut for 81-16 Machine.....
1520c	5529	Feed Regulator Connection Hinge Screw Nut for 81-16 Machine.....

NO.	PLATE	NAME
1520c	5553	Looper (left hand) Lever Connecting Link Hinge Screw Nut for 81-16 Machine..
1520E	3759	Stop Cam Interlocking Rod Case Spring Adjusting Screw Nut for 39344.....
1547D	5545	Presser Lever Screw Stud Nut for 81-16 Machine.....
1547D	5545	Lifting Lever Stop Screw Nut for 42133 and 42144.....
1560c	3722	Tension Regulating Thumb Nut for 17725
1560c	5556	Tension (looper, left hand) Regulating Thumb Nut for 81-16 Machine.....
1560c	5556	Tension (looper, right hand) Regulating Thumb Nut for 81-16 Machine.....
1560c	5556	Tension (needle thread) Regulating Thumb Nut for 81-16 Machine.....
1562J	8580	Bobbin Winder Tension Regulating Thumb Nut for 60770.....
1600E	8580	Treadle Support Bolt Nut for 780.....
1620J	8580	Bobbin Winder Frame Hinge Screw Nut for 41604.....
1651E	5021	Needle Bar Thread Nipper Rod Adjusting Stud Lock Nut for 69-20 and 69-21 Machines.....
1653c	3724	Feed Cam Shaft Nut for 69-20 and 69-21 Machines.....
1654c	8576	Feed Plate Nut for 55345 and 55371....
1654c	8576	Knife Cam Lever Roller and Screw Stud Nut for 1930.....
1655E	5587	Cloth Plate Hinge Screw Nut for 81-16 Machine.....
1655c	5021	Feed Regulator Roller and Screw Stud Nut for 1953.....
1662c	5021	Starting Lever Hinge Screw Nut for 55304
1676c	5047	Feed Across Regulator Adjusting Ball Screw Stud Nut for 69-20 and 69-21 Machines.....
1680c	5530	Feed Regulating Screw Stud Nut for 81-16 Machine.....
1681c	5016	Knife Bar Driving Lever Hinge Screw Nut for 69-20 and 69-21 Machines....
1698c	5021	Knife Holder Pinion Stud Bracket Screw Nut for 55368.....
1728c	7394	Needle Clamping Nut for 81-16 Machine
1822	5021	Thread Take-up Lever Roller and Stud for 18393.....
1952	5047	Feed Across Regulator Roller and Stud for 18356.....

NO.	PLATE	NAME
1953	5021	Feed Regulator Roller and Screw Stud with 1655c and 14017, for 39361 and 55352.....
1980	3759	Knife Cam Lever Roller and Screw Stud with 1654c, for 39330.....
2022	3722	Pulley (tight) Pin for 69-20 and 69-21 Machines.....
2049	5017	Oscillating Shaft Crank Pin for 69-20 and 69-21 Machines.....
2049	5017	Shuttle Driver Pin for 69-20 and 69-21 Machines.....
2058	5046	Presser Bar for 69-20 and 69-21 Machines
2102	3722	Tension Disc for 17725.....
2102	5556	" (looper, left hand) Disc for 81-16 Machine.....
2102	5556	Tension (looper, right hand) Disc for 81-16 Machine.....
2102	5556	Tension (needle thread) Disc for 81-16 Machine.....
2103	3722	Tension Spring for 17725.....
2105	3722	" Thread Guard for 63736.....
2107	3722	Face Plate Thread Guard for 17725.....
2124	3722	Thread Take-up Spring for 17725.....
2127	3722	" " " Regulator Plate for 17725.....
2269	3722	Pulley (loose) Bushing Position Pin for 17942.....
2441	5017	Shuttle Driver 2542 with two 462c, for 69-20 and 69-21 Machines.....
2455	8580	Bobbin Winder Tension Disc for 60770..
2523	5017	Shuttle Bobbin Case Position Finger Rivet for 15277 and 55359.....
2523	5017	Shuttle Race Cap Steady Pin for 55364
2532	7394	Presser Foot Hinge Pin for 42426.....
*2542	—	Shuttle Driver for 2441.....
2749	7394	Feed Eccentric Cover Holder Thumb Screw Washer for 81-16 Machine.....
2763	5564	Rock Shaft for 42143.....
		Nos. 2765 to 2767 FOR 2768
2765	5564	Rock Shaft Knee Arm.....
2766	5564	" " " " Hub with 356c....
2767	5564	" " " " Plate with 356c.....
2768	—	Rock Shaft Knee Arm complete for 42143, Nos. 2765 to 2767.....
2770	5564	Rock Shaft Stop Dog with 356c, for 42143

NO.	PLATE	NAME
2973	5017	Shuttle Bobbin Case Latch Lever for 15141.....
2974	5017	Shuttle Bobbin Case Latch Lever Fulerum Pin for 15141.....
2975	5017	Shuttle Bobbin Case Latch Spring for 15277 and 55359.....
2996	5017	Shuttle Bobbin for 21561 and 55361.....
3012	3722	Feed Cam Driving Worm Wheel Pin for 69-20 and 69-21 Machines.....
3012	3722	Stop Cam Pin for 69-20 and 69-21 Machines.....
3012	3722	Thread Take-up Cam Pin for 69-20 and 69-21 Machines.....
4292	5045	Crank Connecting Rod with 4349 and two 158e, for 69-20 and 69-21 Machines
*4349	—	Crank Connecting Rod Cap for 4292.....
4389	8581	Arm Dowel Pin.....
4448	3722	" Oil Tube, for intermediate bearing, for 69-20 and 69-21 Machines.....
*4449	—	Arm Shaft Bushing (front) for 18439.....
4718	5586	Machine Base Cushion (felt) for 42086..
4784	8576	Oscillating Rock Shaft Oil Pad for 6022
4822	5566	Wrench for 1547 (Accessories).....
4879	5566	Chain Connecting Link for 4885.....
4879	5023	Motor Treadle Chain Connecting Link for 46616.....
4879	5023	Starting Treadle Chain Connecting Link for 46616.....
4881	7219	Motor Treadle for 46616.....
4881	7219	Starting Treadle for 46616.....
4881	5564	Treadle for 4885.....
4882	5023	Motor Treadle Shaft for 46616.....
4882	5023	Starting Treadle Shaft for 46616.....
4882	5566	Treadle Shaft for 4885.....
4883	5023	Motor Treadle Spring for 46616.....
4883	5023	Starting Treadle Spring for 46616.....
4883	5566	Treadle Spring for 4885.....
4884	5564	Treadle Stand for 4885.....
4885	5564	Treadle complete for 42133, Nos. 4879, 4881 to 4884 and two wood screws 1 in. No. 16.....
*6022	5001	Oscillating Rock Shaft (steel) with 4784, for 55278.....
6337	5564	Rock Shaft Lifting Bracket with two 356c, for 42143.....
6439	—	Chain, 36 in. to 45 in., with 56864 and 56865, for 42133.....



## NUMERICAL LIST OF PARTS

NO.	PLATE	NAME
6489	5001	Oscillating Rock Shaft Hinge Pin for 55278
7071	8576	Guide Screw Washer for 81-16 Machine
7071	8576	Knife Bar Connection Screw Washer for 69-20 and 69-21 Machines.....
7071	8576	Thread (needle) Eyelet (double) Screw Washer for 81-16 Machine.....
7125	5564	Rock Shaft Lifting Bracket Hook for 42143.....
7298	8576	Knife Holder Pinion Dowel Pin for 17825
8238	5556	Tension (needle thread) Spring for 81-16 Machine.....
8414	5001	Presser Bar Spring for 69-20 and 69-21 Machines.....
8422	8580	Bobbin Winder Tension Thread Guide for 60770.....
8589	3722	Feed Regulator Bracket Dowel Pin for 69-20 and 69-21 Machines.....
8589	3722	Knife Cam Lever Bracket Dowel Pin for 69-20 and 69-21 Machines.....
8908	5566	Wrench for 1520 and 1655 (Accessories)
9780	8580	Bobbin Winder Tension Bracket Position Stud for 60770.....
9842	5586	Machine Base Thumb Screw Spring Washer (Accessories).....
10106	5544	Needle Bar Thread Retainer Disc for 81-16 Machine.....
10107	5544	Needle Bar Thread Retainer Spring for 81-16 Machine.....
10148	5556	Tension (looper, right hand) Spring for 81-16 Machine.....
10875	5023	Wrench for 1518 and 1520 (Attachments and Accessories).....
11831	5023	Screw Driver, large (Attachments and Accessories).....
12242	5564	Rock Shaft Hanger with two wood screws 1 in. No. 10, for 42143.....
12424	5017	Oscillating Shaft Crank Slide Block Cap Screw Washer for 15171.....
14017	5047	Feed Regulator Roller and Screw Stud Nut Washer for 1953.....
14063	5586	Machine Base Thumb Screw Spring (Accessories).....
14079	8581	Arch Clamp Frame Dowel Pin for 55345 and 55371.....
15027	5017	Shuttle Bobbin Case Position Finger for 15277.....

## NUMERICAL LIST OF PARTS

NO.	PLATE	NAME
15072	8576	Bobbin Winder Bobbin Position Pin for 27538.....
15140	5017	Shuttle Bobbin Case Latch for 15141....
15141	—	“ “ “ Hinge for 15277 and 55359, Nos. 2973, 2974 and 15140....
15170	5017	Oscillating Shaft Crank Slide Block for 15171.....
15171	5017	Oscillating Shaft Crank Slide Block complete for 18387, Nos. 229D, 1035c, 12424 and 15170.....
15261	7009	Protector Rod Collar with 237F, for 63753
15261	7009	“ “ Spring Collar with 237F, for 63753.....
15277	5017	Shuttle Bobbin Case complete for 21561, Nos. 591F, 592E, 2523, 2975, 15027, 15141 and 15278.....
15278	5017	Shuttle Tension Spring for 15277.....
16532	3722	Stop Cam Interlocking Rod Case Bracket Dowel Pin for 69-20 and 69-21 Machines
17547	5556	Tension (looper, right hand) Thread Guide for 81-16 Machine.....
17702	3728	Arm Shaft for 69-20 and 69-21 Machines.
17703	5001	“ “ Bushing (back) for 69-20 and 69-21 Machines.....
17708	8575	Arch Clamp Foot Lifter with 17866, for 69-21 Machine.....
17724	5001	Face Plate for 63736.....
17725	—	Face Plate complete for 69-20 and 69-21 Machines, Nos. 448c, 600c, 1560c, 2103, 2107, 2124, 2127, 63736 and two each 233D and 2102.....
17738	5047	Feed Across Regulator Adjusting Ball Screw Stud Nut Washer for 69-20 and 69-21 Machines.....
17739	8580	Feed Across Regulator Adjusting Stud Sleeve for 69-20 and 69-21 Machines, obsolete.....
17741	8581	Belt Cover Bracket Stud for 39290.....
17744	5047	Feed Regulator Hinge Stud for 69-20 and 69-21 Machines.....
17797	5048	Feed Cam Driving Worm Wheel with 453c, for 69-20 Machine.....
17805	5007	Feed Plate Carrier Bar Pivot Block for 69-20 and 69-21 Machines.....
17806	8576	Feed Plate Position Stud for 55349 and 55374.....

## NUMERICAL LIST OF PARTS

NO.	PLATE	NAME
17822	8576	Knife Bar Rack Rivet for 18370.....
17825	8576	" Holder with 17826, 17830 and two 7298, for 55323.....
17826	8576	Knife Holder Pinion for 17825.....
17827	8576	" " " Stud for 17828.....
17828	8576	" " " " Bracket with 17827, for 55368.....
17829	8576	Knife Thread Holder for 55323.....
17830	8576	" " " Position Pin for 17825.....
17831	5046	Needle Bar with 237F, for 69-20 and 69-21 Machines.....
17834	3718	Needle Bar Thread Nipper Lever with 17835, for 69-20 and 69-21 Machines..
17835	3718	Needle Bar Thread Nipper Lever Bushing for 17834.....
Nos. 17837 TO 17846 FOR 69-20 AND 69-21 MACHINES		
17837	5045	Needle Bar Thread Nipper Rod.....
17838	3718	" " " " " Adjusting Stud.....
17839	3718	Needle Bar Thread Nipper Rod Arm with 196F.....
17840	5001	Needle Bar Thread Nipper Rod Support
17841	3718	Presser Bar Collar with two 196F.....
17842	3718	" " Guide Bracket with 453c....
17843	5045	" " Lifting Lever.....
17844	5049	" " " " Bracket for 18439.....
17845	5046	Presser Bar Lifting Lever Rod.....
17846	—	" " " " " Chain....
17848	5049	Pulley (loose) Bushing for 17955.....
17853	5048	Starting Lever for 55304.....
17854	3721	Stop Cam for 17955.....
17855	3721	" " Interlocking Rod for 55285....
17859	5048	" " " " Case Socket Joint for 55304.....
17861	3721	Stop Cam Interlocking Rod Case Stop Stud for 55304.....
17862	3721	Stop Cam Interlocking Rod Case Stop Stud Spring for 55304.....
17863	3721	Stop Cam Interlocking Rod Spring for 55285.....
17864	3721	Stop Cam Interlocking Rod Stop for 55285
17865	7229	Thread Wiper Body for 69-21 Machine..

## NUMERICAL LIST OF PARTS

NO.	PLATE	NAME
17866	7229	Thread Wiper Body Hook for 17708 and 39206.....
17867	7229	Thread Wiper Body Support for 69-20 and 69-21 Machines.....
17868	7229	Thread Wiper Body Wire for 69-20 and 69-21 Machines.....
17869	7229	Thread Wiper Body Wire Screw Washer for 69-20 and 69-21 Machines.....
17872	3721	Trip Lever for 55304.....
17873	3721	" " Spring for 55304.....
17874	7229	Tripping Point for 18410 and 55372....
17876	3728	Treadle with 443c, for 17884.....
Nos. 17877 TO 17879 FOR 17880		
17877	3728	Treadle Pitman Rod (lower).....
17878	3728	" " " (upper).....
17879	3728	" " " Clamp with two 161b.....
17880	3728	Treadle Pitman complete for 17885, Nos. 17877 to 17879.....
Nos. 17881 TO 17883 FOR 17884		
17881	8580	Treadle Shaft.....
17882	3718	" Spring.....
17883	3728	" Stand.....
17884	—	Treadle complete for 17885, Nos. 17876, 17881 to 17883 and two wood screws 1 in. No. 10.....
17885	—	Treadle and Pitman complete for 69-20 and 69-21 Machines, Nos. 17880 and 17884.....
17886	5048	Starting Lever Pitman for 69-20 and 69-21 Machines.....
17892	3728	Table Belt Guide Bracket with two 153e, for 39221.....
17893	3728	Table Belt Guide Pulley for 39221.....
17896	3718	" " " " Shaft Plug for 39219 and 39220.....
17905	5023	Wrench for 1654 and 1676 (Attachments and Accessories)
17915	5016	Knife Bar Connection Slide Block for 17917.....
17916	5016	Knife Bar Connection Slide Block Stud for 17917.....
17917	—	Knife Bar Connection Slide Block 17915 with 17916, for 18372.....

## NUMERICAL LIST OF PARTS

NO.	PLATE	NAME
17919	5016	Knife Bar Driving Lever Lock Stud Spring for 39297.....
17941	5049	Pulley (loose) 2 $\frac{1}{8}$ in. diam., for 17955 ...
17942	5049	" (tight) 2 $\frac{1}{8}$ in. diam., with 2269, for 17955.....
17955	—	Pulleys complete for 69-20 and 69-21 Machines, Nos. 1202D, 1206c, 17848, 17854, 17941 and 17942.....
17960	8581	Arch Clamp Foot Plate for 55374.....
*18352	—	Cylinder for 69-21 Machine.....
18353	5045	Feed Across Connection with 18354 and two 175E, for 69-20 and 69-21 Machines, obsolete.....
*18354	—	Feed Across Connection Cap for 18353, obsolete.....
18355	8580	Feed Across Knuckle Joint for 69-20 and 69-21 Machines, obsolete.....
18356	5045	Feed Across Regulator with 1952, for 55354 and 55375.....
18357	5047	Feed Across Regulator Hinge Stud for 55354 and 55375.....
18358	5046	Feed Across Shaft for 69-20 and 69-21 Machines.....
18359	5047	Feed Across Shaft Collar with two 200r, for 69-20 and 69-21 Machines.....
18362	5007	Feed Across Shaft Crank (front) with 160E and 18363, for 69-20 and 69-21 Machines.....
18363	5007	Feed Across Shaft Crank (front) Stud for 18362.....
18364	5007	Feed Across Shaft Crank (front) Stud Slide Block for 69-20 and 69-21 Machines.....
18366	5007	Feed Plate Carrier Bar Block for 55374.....
18367	5007	" " " " " Cover for 55371.....
18370	5044	Knife Bar with 18373 and two 17822, for 69-20 and 69-21 Machines.....
18372	5016	Knife Bar Connection with 17917, for 69-20 and 69-21 Machines.....
18373	8576	Knife Bar Rack for 18370.....
18384	5007	Feed Cam Pin for 69-20 and 69-21 Machines.....
18385	5046	Oscillating Shaft for 69-20 and 69-21 Machines.....
18386	—	Oscillating Shaft Crank for 18387.....

## NUMERICAL LIST OF PARTS

NO.	PLATE	NAME
18387	5017	Oscillating Shaft Crank complete for 69-20 and 69-21 Machines, Nos. 237F, 1519E, 15171 and 18386.....
18388	8581	Cylinder Block for 69-20 and 69-21 Machines.....
18390	5007	Feed Plate Carrier Bar Plate for 55349 and 55374.....
18392	5045	Thread Take-up Cam 55302 with 446c, for 69-20 and 69-21 Machines.....
*18393	5049	Thread Take-up Lever with 1822, for 55283.....
18410	—	Feed Cam with 17874 and two each 190D and 1192c, for 69-20 Machine.....
18413	8577	Shuttle Race Ring Spring for 55364.....
18415	5007	Feed Cam Driving Worm with 1441c and 1442c, for 69-20 Machine.....
18416	5046	Feed Cam Shaft for 69-20 and 69-21 Machines.....
18417	5049	Feed Cam Shaft Bracket for 69-20 and 69-21 Machines.....
18419	—	Cylinder Base Plate with two 453c, for 18424.....
18420	8580	Cylinder Base Plate Hinge Connection for 18424.....
18421	5047	Feed Across Shaft Crank (back) with 160E and 200c, for 69-20 and 69-21 Machines.....
18422	5047	Feed Across Shaft Crank (back) Ball Stud for 69-20 and 69-21 Machines, obsolete.....
18423	8580	Cylinder Base Plate Hinge Connection Hinge Pin for 18424.....
18424	5044	Cylinder Base Plate (hinged) complete for 69-20 and 69-21 Machines, Nos. 18419, two each 18420, 18423, three wood screws 1 $\frac{1}{4}$ in. No. 12 and four 134D (Attachments and Accessories).....
*18437	5046	Feed Plate Carrier Bar for 55349 and 55374.....
*18439	—	Arm with 4449, 17844 and two 164E, for 69-20 and 69-21 Machines.....
18443	8581	Stop Cam Interlocking Rod Case Wearing Block for 18492.....
18469	5048	Feed Regulator Bracket with 690D, 39310 and two 160D, for 55375.....
18470	5048	Knife Cam Lever Bracket with 1177D, for 69-20 and 69-21 Machines.....

## NUMERICAL LIST OF PARTS

NO.	PLATE	NAME
18471	3759	Knife Cam Lever Hinge Screw Bushing for 18472.....
*18472	—	Knife Cam Lever Hinge Screw Bushing 18471 with 50029c, for 69-20 and 69-21 Machines.....
18488	3759	Feed Regulator Post for 55374.....
18489	3759	" " " Guide for 55345 and 55371.....
18492	5049	Stop Cam Interlocking Rod Case 55387 with 18443 and two 193b, for 55285...
18493	—	Stop Cam Interlocking Rod Case Bracket 55304 with 39343, 39344 and two 1186c, for 69-20 and 69-21 Machines.....
18498	5044	Belt Cover for 69-20 and 69-21 Machines
19045	7394	Frame Side Cover (left) Handle for 42193
19793	8576	Knife Cam Lever Slide Steady Pin for 39329.....
*21358	—	Feed Across Connection Cap (lower) for 55376.....
21561	5017	Shuttle, 1 $\frac{1}{8}$ in. diam., for 69-21 Machine, Nos. 2996, 15277 and 21562.....
21562	5017	Shuttle Body for 21561 and 55361.....
21623	8577	" Race Cap for 55364.....
21629	3718	Needle Bar Connecting Stud with 155c, for 63756.....
22003	5023	Wrench for 1651 (Attachments and Accessories).....
25086	5023	Wrench for 25285.....
25127	7229	Belt Hook for 25490.....
25285	—	Stand (iron work) complete for 69-20 and 69-21 Machines, Nos. 25086, 46618, 46667, two each 780E, 46522 and four 748E.....
25490	—	Belt, size $\frac{1}{4}$ in., length 36 in., with 25127, for 25285.....
26026	5023	Screw Driver, machine (Attachments and Accessories).....
26151	5566	Screw Driver (Accessories).....
26485	5023	" " shuttle tension (Attachments and Accessories).....
27321	8579	Bobbin Winder Frame for 41604.....
27328	8579	" " Stop Latch for 41604.....
27538	8579	" " Spindle 27849 with 15072, 27850 and 41828, for 41604.....
27662	5023	Wrench for 1508 (Attachments and Accessories).....

## NUMERICAL LIST OF PARTS

NO.	PLATE	NAME
27739	7234	Thread Unwinder Thread Cone (wood) for large cones, for 225396 and 225397....
*27849	—	Bobbin Winder Spindle for 27538.....
*27850	—	" " " Collar for 27538..
27916	5016	" " Brake (leather) for 41598.
28084	5016	" " " Rivet for 41598...
29599	7394	Looper (right hand) and Spreader Lever Connection Oil Tube Packing (felt) for 42106.....
*39203	3718	Needle Bar Connecting Link for 63756..
39206	8581	Arch Clamp Foot Lifter with 17866, for 69-20 Machine.....
39211	5045	Feed Cam Driving Worm with 1441c and 1442c, for 69-21 Machine,.....
39212	5045	Feed Cam Driving Worm Wheel with 453c, for 69-21 Machine.....
		Nos. 39218 TO 39220 FOR 39221
39218	3728	Table Belt Guide Belt Guide with two 168E.....
39219	3728	Table Belt Guide Pulley Shaft (long) with 17896.....
39220	3728	Table Belt Guide Pulley Shaft (short) with 17896.....
39221	—	Table Belt Guide complete for 69-20 and 69-21 Machines, Nos. 17892, 39219, 39220, two each 17893, 39218 and three wood screws $\frac{1}{4}$ in. No. 12.....
39222	5001	Belt Shifter for 55285.....
39223	8581	" " Clamp for 55285.....
39235	5048	Knife Cam Lever Body for 39409.....
39276	8576	Needle Bar Thread Nipper Lever Spring for 69-20 and 69-21 Machines.....
39290	5001	Belt Cover Bracket with 184E and 17741, for 69-20 and 69-21 Machines.....
39297	5016	Knife Bar Driving Lever with 190b, 1420E, 17919 and 39298, for 69-20 and 69-21 Machines.....
39298	5016	Knife Bar Driving Lever Lock Stud for 39297.....
39303	8581	Arch Clamp Foot Spring for 55345 and 55371.....
*39310	—	Feed Regulator Bracket Cap for 18469 and 55353.....
39313	3759	Feed Regulator Swivel for 55375.....
39329	5048	Knife Cam Lever complete for 69-20 and 69-21 Machines, Nos. 19793 and 39409

## NUMERICAL LIST OF PARTS

NO.	PLATE	NAME
39330	3759	Knife Cam Lever Slide with 1980, for 39460
39331	3759	" " " " Screw Washer for 39460
39343	5049	Stop Cam Interlocking Rod Case Spring (flat) for 18493
39344	3759	Stop Cam Interlocking Rod Case Spring Bracket with 430c and 1520E, for 18493
39346	5049	Stop Cam Interlocking Rod Case Bracket for 55304
39350	5045	Needle Bar Thread Nipper Driving Lever (adjustable) with 39351 and two 335D, for 69-20 and 69-21 Machines
39351	3759	Needle Bar Thread Nipper Driving Lever Extension for 39350
39352	5045	Needle Bar Thread Nipper Driving Lever Spring for 69-20 and 69-21 Machines
39361	5048	Feed Regulator with 1953, for 55375
39409	—	Knife Cam Lever Body 39235 with 39460, for 39329
39460	—	Knife Cam Lever Slide 39330 with 1255D and 39331, for 39409
39489	7008	Protector Arm with 39490, for 63753
39490	—	" Blade for 39489
Nos. 39491 to 39494 FOR 63753		
39491	7008	Protector Bracket with two each 426c and 448c
39492	7009	Protector Crank with 160c
39493	7009	" " Bracket with 1120c and two 454c
39494	7008	Protector Rod
39495	7009	" " Connection for 39498
39496	7008	" " Sleeve for 63753
39497	7009	" " Spring for 63753
39498	—	Protector (front of needle) complete for 69-20 and 69-21 Machines, Nos. 39495, 63753 and two each 176D and 50351D
39541	5545	Presser Foot Screw Washer for 81-16 Machine
40247	5544	Needle Bar Connecting Link Hinge Pin for 81-16 Machine
41400	5023	Machine Rest Pin, wood (Attachments and Accessories)
41598	8579	Bobbin Winder Base with 27916 and two 28084, for 41604
41600	8579	Bobbin Winder Pulley with 155c, for 41604

## NUMERICAL LIST OF PARTS

NO.	PLATE	NAME
41604	8579	Bobbin Winder for 41716, Nos. 35D, 1620E, 27321, 27328, 27538, 41598, 41600, 41825 and 50356D
41715	5023	Bobbin Winder Bracket for 41716
41716	—	Bobbin Winder (swinging automatic, left hand) complete for 2996 for 69-20 and 69-21 Machines, Nos. 161D, 41604, 60770 and two 1186c
41825	8580	Bobbin Winder Frame Spring for 41604
41828	8580	" " Spindle Collar Pin for 27538
42001	5576	Balance Wheel, 2 1/8 in. pulley, with 424c and 1354c, for 81-16 Machine
42002	5526	Cloth Plate for 42107
42003	5526	" " Extension (lower) for 42107
42005	5526	" " Lock Spring for 42107
42007	5529	Feed Bar Hinge Pin for 81-16 Machine
42008	5529	" Connecting Rod with 42009 and two 1057E, for 81-16 Machine
*42009	—	Feed Connecting Rod Cap for 42008
Nos. 42011 to 42026 FOR 81-16 MACHINE		
42011	5529	Feed Eccentric with two 453c
42012	5529	" Lifting Eccentric with two 462c
42013	5529	" " " Connection
42014	5530	" Regulator with 233D and two 1259C
42015	5529	" " Connection with 1012E
42016	5530	" " Hinge Stud
42017	5529	" " Indicator
42018	5530	" " " Plate
42019	5530	" Rock Shaft for 42020
42020	—	Feed Rock Shaft complete, Nos. 42019 and 42021
42021	5530	Feed Rock Shaft Crank with 157E, for 42020
*42022	—	Frame
42023	5576	" Rotary Shaft
42024	5576	" " " Bushing (front)
42025	5553	" " " Crank with 1259c and 1375c
42026	5576	Frame Rotary Shaft Flanged Bushing (back)
42028	5526	Frame Side Cover (right) hinged, for 81-16 Machine
42029	5576	Frame Top Cover for 81-16 Machine
42045	5545	Presser Lever Hinge Stud for 81-16 Machine

## NUMERICAL LIST OF PARTS

NO.	PLATE	NAME
Nos. 42050 TO 42055 FOR 81-16 MACHINE		
42050	5553	Looper (left hand).....
42051	5553	" " " Lever with 209H.....
42052	5553	" " " " Connecting Link
42053	5553	" " " " Hinge Stud.....
42054	5544	Needle Bar.....
42055	5544	" " " Connecting Link.....
42057	5544	" " " Rod with 42059, 42076 and four 896E, for 81-16 Machine
*42059	—	Looper (right hand) and Spreader Lever Connection Cap (upper) for 42075....
*42059	—	Needle Bar Connecting Rod Cap (upper) for 42057.....
42061	5544	Needle Bar Connecting Bracket with 187D and 223F, for 81-16 Machine.....
42066	5544	Needle Guard for 81-16 Machine.....
42069	5545	Presser Lever for 81-16 Machine.....
42070	5545	" " " Lifter for 81-16 Machine....
42071	5545	" " " Spring for 81-16 Machine..
42073	5553	Looper (right hand) and Spreader Lever with 1259c, for 81-16 Machine.....
42074	5553	Looper (right hand) and Spreader Lever Ball Stud for 81-16 Machine.....
42074	5553	Needle Bar Crank (back) Ball Stud for 81-16 Machine.....
42075	5553	Looper (right hand) and Spreader Lever Connection with 42059, 42076 and four 896E, for 81-16 Machine.....
*42076	—	Looper (right hand) and Spreader Lever Connection Cap (lower) for 42075....
*42076	—	Needle Bar Connecting Rod Cap (lower) for 42057.....
42077	7394	Looper (right hand) and Spreader Lever Connection Guide for 81-16 Machine
42077	7394	Needle Bar Connecting Rod Guide for 81-16 Machine.....
42078	7394	Looper (right hand) and Spreader Lever Hinge Pin for 81-16 Machine.....
42079	5530	Feed Rock Shaft Hinge Pin Bushing for 81-16 Machine.....
42079	5530	Looper (right hand) and Spreader Lever Hinge Pin Bushing for 81-16 Machine
42082	5556	Tension (needle thread) Thread Guide for 81-16 Machine.....
42084	5556	Thread (looper, left hand) Tube for 81-16 Machine.....

## NUMERICAL LIST OF PARTS

NO.	PLATE	NAME
42086	5564	Machine Base with three wood screws 1¼ in. No. 12 and four each 935D, 4718 and 42088, for 81-16 Machine..
42088	5586	Machine Cushion (felt) for 42086.....
42089	5566	Wrench for 1324, 1374 and 1728 (Acces- sories).....
42090	5566	Threading Wire (Accessories).....
42093	5556	Thread (looper, right hand) Staple for 81-16 Machine.....
42094	5526	Feed Eccentric Cover for 81-16 Machine.
42098	5530	" Rock Shaft Hinge Pin for 81-16 Machine.....
Nos. 42102 TO 42108 FOR 81-16 MACHINE		
42102	7394	Feed Eccentric Cover Holder.....
42103	5544	Needle Bar Crank (back) with 1258c and two 1259c.....
42104	5544	Needle Bar Crank (front) with 904c, 1258c and 1259c.....
42105	5544	Needle Bar Crank Shaft.....
42106	7394	Looper (right hand) and Spreader Lever Connection Oil Tube and Bracket with 29599.....
42107	—	Cloth Plate complete, Nos. 42002, 42003, 42005, 42108, two 236D and five 229E
42108	5526	Cloth Plate Extension (upper) for 42107
42115	5544	Needle Bar Thread Retainer Bracket for 81-16 Machine.....
42121	5556	Tension (looper, left hand) Spring for 81-16 Machine.....
42126	7394	Thread (looper, right hand) Pull-off for 81-16 Machine.....
42127	5556	Thread (looper, right hand) Take-up for 81-16 Machine.....
Nos. 42130 TO 42132 FOR 42133 AND 42144		
42130	5586	Lifting Lever.....
42131	5586	" " Bracket.....
42132	5586	" " Spring.....
42133	—	Foot Lifter complete for 81-16 Machine, Nos. 1301D, 4885, 6439, 42130 to 42132 and two each 1148F, 1229c and 1547D
42142	5564	Lifting Lever Connecting Rod for 42144
42143	5564	Rock Shaft complete for 42144, Nos. 2763, 2768, 6337, 7125 and two each 2770 and 12242.....

## NUMERICAL LIST OF PARTS

NO.	PLATE	NAME
42144	—	Knee Lifter complete for 81-16 Machine, Nos. 1301D, 42130 to 42132, 42142, 42143 and two each 1148F, 1229C and 1547D.
42166	5553	Looper (right hand) for 81-16 Machine.
42192	7394	Frame Side Cover (right) Lock Spring for 81-16 Machine.
42193	5588	Frame Side Cover (left) with 19045, for 81-16 Machine.
42195	5588	Needle Guard Holder for 81-16 Machine
42205	5588	Feed Bar with 1253C, for 81-16 Machine
42242	7394	Thread (looper, left hand) Eyelet for 81-16 Machine.
*42251	—	Arm with two each 462C and 42253, for 81-16 Machine.
42253	5544	Needle Bar Bushing for 42251.
42290	5530	Feed Regulating Screw Stud Washer for 81-16 Machine.
42367	7394	Frame Rotary Shaft Front Bearing Oil Pad (braided cotton) for 81-16 Machine.
Nos. 42422 to 42433 FOR 81-16 MACHINE		
42422	7395	Feed Dog.
42423	7394	Guide.
42424	—	Presser Foot Plate for 42426.
42425	—	“ “ Shank for 42426.
42426	7395	Presser Foot (hinged) complete, Nos. 2532, 42424 and 42425.
42427	7395	Spreader.
42428	7395	Thread (needle) Eyelet (double).
42429	7395	“ “ Controller.
42430	7395	Throat Plate for 42433.
42431	7395	“ “ Chaining-off Finger for 42433.
42432	7395	Throat Plate Chaining-off Finger, for purl stitch, for 42433.
42433	—	Throat Plate complete for 42422, Nos. 42430, 42431 and two 50169D.
42639	8576	Knife (stationary) Bracket Pin for 55366
43808	8580	Bobbin Winder Tension Spring for 60770
46522	7219	Leg for 25285.
46614	7219	Motor Treadle Bracket (left) for 46616
46614	7219	Starting Treadle Bracket (left) for 46616
46615	7219	Motor Treadle Bracket (right) for 46616
46615	7219	Starting Treadle Bracket (right) for 46616
46616	7219	Motor Treadle complete for 46618, Nos. 4879, 4881 to 4883, 46614 and 46615

## NUMERICAL LIST OF PARTS

NO.	PLATE	NAME
46616	7219	Starting Treadle complete for 46618, Nos. 4879, 4881 to 4883, 46614 and 46615
46617	7219	Treadle Support for 46618.
46618	—	“ “ 46617 with two 46616 and four 1177E, for 25285.
46667	7219	Brace for 25285.
50018F	5021	Knife Holder Pinion Stud Bracket Screw for 55368.
50029C	3759	Knife Cam Lever Hinge Screw for 18472
50117J	8576	“ (stationary) Screw for 55368.
50169D	7395	Throat Plate Chaining-off Finger Screw for 42433.
50333C	8581	Arm Shaft Bushing (back) Adjusting Screw for 69-20 and 69-21 Machines.
50351D	7009	Protector Bracket Screw for 39498.
50356D	8580	Bobbin Winder Frame Hinge Screw for 41604.
50562C	7394	Looper (left hand) Lever Connecting Link Hinge Screw for 81-16 Machine.
50598C	5047	Feed Across Regulator Adjusting Ball Screw Stud for 55379.
52598	7009	Protector Crank Hinge Stud for 63753.
54967	7394	Frame Rotary Shaft Flanged Bushing (back) Oil Pad (braided cotton) for 81-16 Machine.
55278	—	Oscillating Rock Shaft complete for 69-20 and 69-21 Machines, Nos. 1513J, 6022 and 6489.
55283	—	Thread Take-up Lever 18393 with 79C, for 69-20 and 69-21 Machines.
*55285	—	Stop Cam Interlocking Rod Case 18492 with 1318D, 17855, 17863, 17864, 39222, 39223 and two 1255D, for 55304.
55300	8576	Feed Plate Carrier Bar Block Steady Pin for 55349 and 55374.
*55302	—	Thread Take-up Cam for 18392.
55304	—	Stop Cam Interlocking Rod Case Bracket complete for 18493, Nos. 1182E, 1196C, 1204E, 1254C, 1262C, 1508E, 1662C, 17853, 17859, 17861, 17862, 17872, 17873, 39346, 55285 and two 898D.
55319	8576	Knife (needle thread) for 55323.
55320	8576	“ (shuttle thread) for 55323.
55321	8576	“ (stationary) for 55368.
*55322	8576	“ “ Bracket for 55366.
55323	—	“ Holder 17825 with 1198C, 17829, 55319 and 55320, for 55368.

## NUMERICAL LIST OF PARTS

NO.	PLATE	NAME
55326	8578	Throat Plate Needle Hole Bushing for 55367.....
55341	8581	Arch Clamp Foot with 55342, for 55345.
55342	8581	" " " Lifting Stud for 55341.
55343	8581	" " " Plate for 55345.....
55344	5043	" " " Frame for 55345.....
55345	—	Arch Clamp complete for 69-20 Machine, Nos. 810j, 1175j, 1654c, 18489, 39303, 55341, 55343, 55344, 55348, 55349, 55351, two each 181d, 14079 and five 217j.....
*55346	—	Cylinder for 69-20 Machine.....
55347	5046	" " End Cover for 69-20 and 69-21 Machines.....
55348	8575	Feed Plate for 55345.....
55349	—	" " Carrier Bar 18437 with 934j, 1195e, 1221c, 18390, 55350, 55355, two 55300 and four 17806, for 55345.....
55350	5047	Feed Plate Carrier Bar Block for 55349..
55351	8575	" " " " " Cover for 55345.....
55352	5048	Feed Regulator with 1953, for 55354.....
55353	5048	" " Bracket with 690d, 39310 and two 160d, for 55354.....
55354	—	Feed Regulator Bracket 55353 with 18356, 18357, 55352 and 55356, for 69-20 Machine.....
55355	5047	Feed Regulator Post for 55349.....
55356	8575	" " Swivel for 55354.....
55357	8576	Knife Bar Cap for 69-20 and 69-21 Machines.....
55358	—	Shuttle Bobbin Case Position Finger for 55359.....
55359	8577	Shuttle Bobbin Case complete for 55361, Nos. 591f, 592e, 2523, 2975, 15141, 55358 and 55360.....
55360	8577	Shuttle Tension Spring for 55359.....
55361	—	Shuttle, 1 $\frac{1}{16}$ in diam., for 69-20 Machine, Nos. 2996, 21562 and 55359.....
55362	—	Shuttle Race Body for 55364.....
55363	8577	" " Ring for 55364.....
55364	8577	Shuttle Race (flexible) complete for 69-20 and 69-21 Machines, Nos. 662d, 2523, 21623, 55362, 55363 and two each 1289d and 18413.....
55365	8576	Thread Wiper Body for 69-20 Machine...

## NUMERICAL LIST OF PARTS

NO.	PLATE	NAME
55366	—	Throat Plate with 55322 and two 42639, for 55367.....
55367	8578	Throat Plate 55366 with 55326 and two 1208d, for 55368.....
55368	—	Throat Plate complete for 69-20 and 69-21 Machines, Nos. 1698c, 17828, 50018f, 50117j, 55321, 55323 and 55367.....
55369	8575	Arch Clamp Foot with 63726, for 55371..
55370	5043	" " Frame for 55371.....
55371	—	Arch Clamp complete for 69-21 Machine, Nos. 810j, 1175j, 1654c, 17960, 18367, 18489, 39303, 55369, 55370, 55373, 55374, two each 181d, 14079 and five 217j.....
55372	—	Feed Cam with 17874 and two each 190d and 1192c, for 69-21 Machine.....
55373	8575	Feed Plate for 55371.....
55374	—	" " Carrier Bar 18437 with 934j, 1195e, 1221c, 18366, 18390, 18488, two 55300 and four 17806, for 55371.....
55375	—	Feed Regulator Bracket 18469 with 18356, 18357, 39313 and 39361, for 69-21 Machine.....
55376	5045	Feed Across Connection with 21358, 55377 and four 1057e, for 55379.....
*55377	—	Feed Across Connection Cap (upper) for 55376.....
55379	—	Feed Across Connection 55376 with 50598c and 55382, for 69-20 and 69-21 Machines.....
55382	5047	Feed Across Shaft Crank (back) Ball Stud for 55379.....
55387	—	Stop Cam Interlocking Rod Case for 18492
56864	5566	Chain Hook (large) for 6439.....
56865	7229	" " (small) for 6439.....
60769	8579	Bobbin Winder Tension Bracket for 60770
60770	8579	Bobbin Winder Tension Bracket complete for 41716, Nos. 419e, 1562j, 8422, 9780, 43808, 60769 and two 2455.....
60913	7233	Thread Unwinder Spool Weight with 60914, for 225396 and 225397.....
60914	7229	Thread Unwinder Spool Weight Centre Pin for 60913.....
63726	8575	Arch Clamp Foot Lifting Stud for 55369
*63736	—	Face Plate 17724 with 2105, for 17725
63753	—	Protector (front of needle) for 39498, Nos. 1099f, 39489, 39491 to 39494, 39496, 39497, 52598 and two 15261.....



## NUMERICAL LIST OF PARTS

NO.	PLATE	NAME
63756	---	Needle Bar Connecting Link 39203 with 21629, for 69-20 and 69-21 Machines
120341	4079	Tweezers, curved (Attachments and Accessories).....
120344	5566	Oiler (copper plated) with 120345 (Accessories).....
120345	5566	Oiler Spout, 5 in. long, for 120344.....
120346	4079	" (copper plated) with 120347 (Attachments and Accessories).....
120347	4079	Oiler Spout, 9 in. long, for 120346.....
200383c	7229	Thread Unwinder Spool Rest Rod Set Screw for 202490.....
201018c	7229	Thread Unwinder Spool Rest Set Screw for 225389 and 225395.....
201696j	7229	Thread Unwinder Thread Guide Lock Nut for 225396 and 225397.....
202490	7233	Thread Unwinder Spool Stand with 200383c, for 225396 and 225397.....
225388	7233	Thread Unwinder Spool Rest Rod for 225396 and 225397.....
225389	7165	Thread Unwinder Spool Rest with 201018c, for 225397.....
225390	7234	Thread Unwinder Thread Cone Holder, for inverted cones, for 225396 and 225397
225391	7233	Thread Unwinder Thread Guide for 225396 and 225397.....
225392	7233	Thread Unwinder Thread Guide Rod with 208E and 225393, for 225396 and 225397
225393	7229	Thread Unwinder Thread Guide Rod Washer for 225392.....
225395	7233	Thread Unwinder Spool Rest with 201018c, for 225396 and 225397.....
225396	7233	Thread Unwinder complete, for two spools, for 69-20 and 69-21 Machines, Nos. 201696j, 202490, 225388, 225392, 225395, two each 60913, 225391 and three wood screws $\frac{1}{8}$ in. No. 13.....
225397	7165	Thread Unwinder complete, for three spools, for 81-16 Machines, Nos. 201696j, 202490, 225388, 225389, 225392, 225395, three each 60913, 225391 and three wood screws $\frac{1}{8}$ in. No. 13.....

PLATE 3718—FULL SIZE

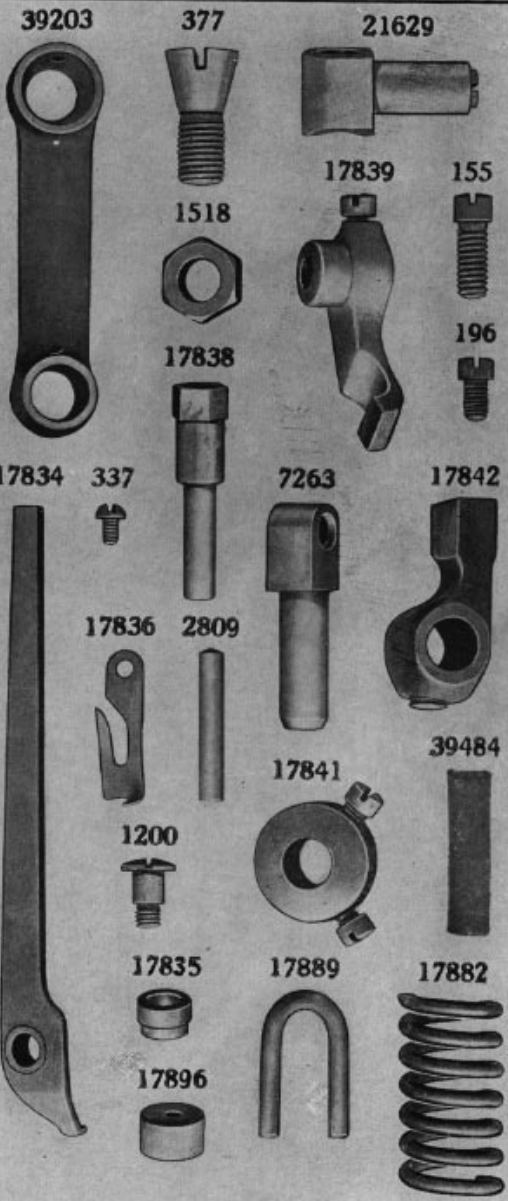

PLATE 3721—FULL SIZE

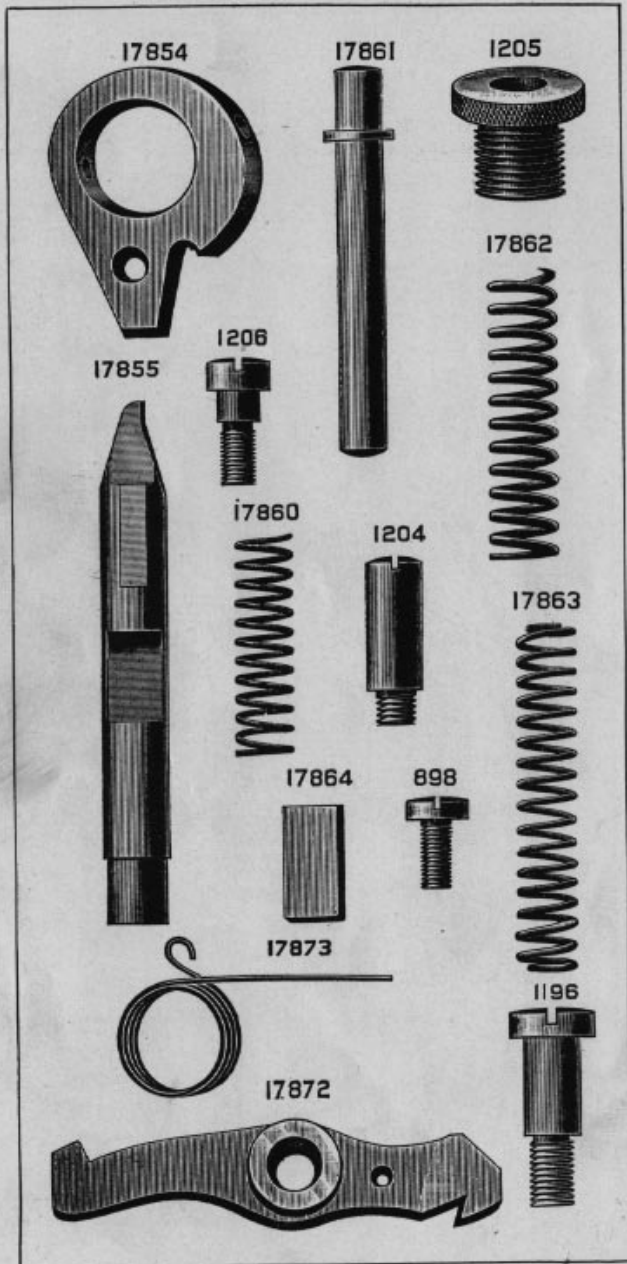

PLATE 3722—FULL SIZE

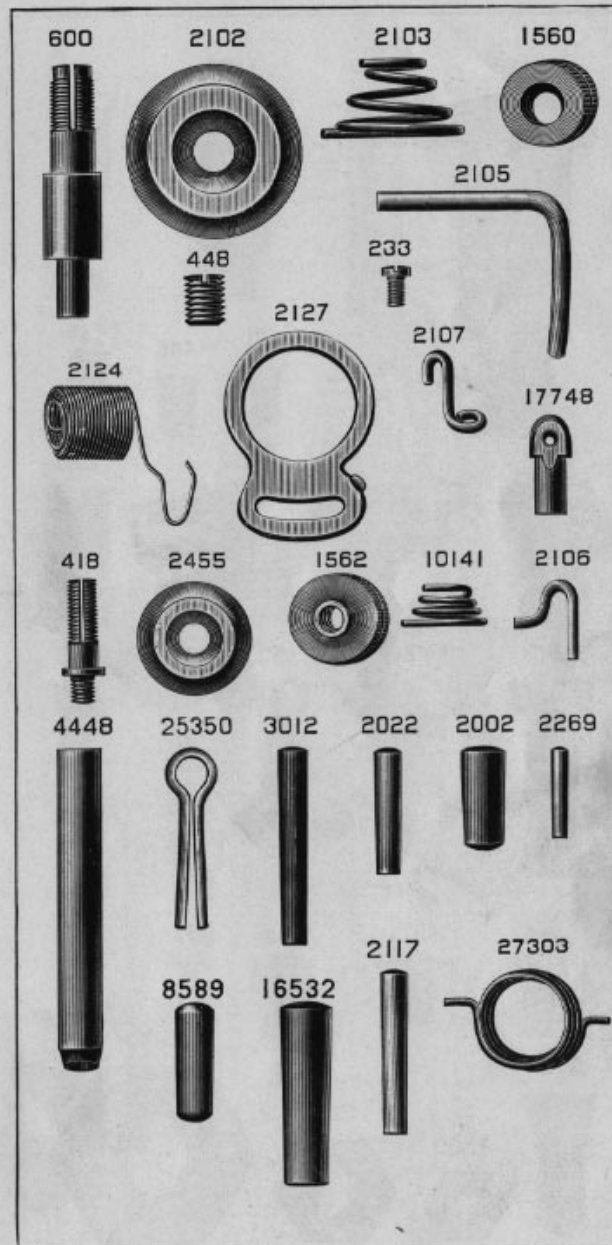

PLATE 3724—FULL SIZE

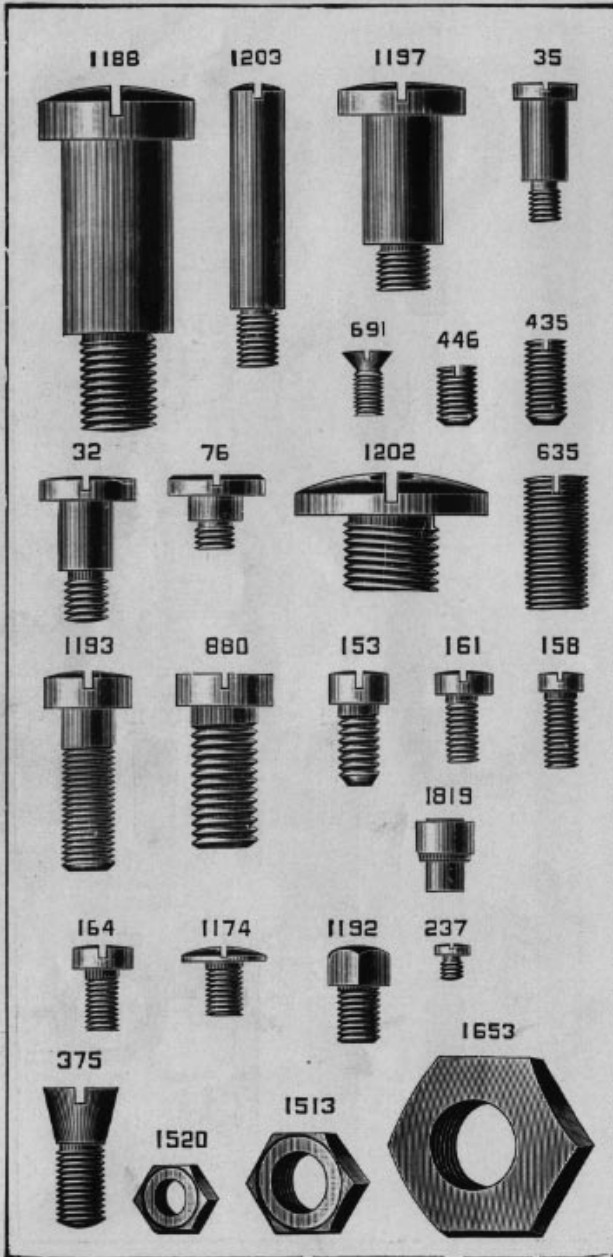

PLATE 3728—ONE-FOURTH SIZE

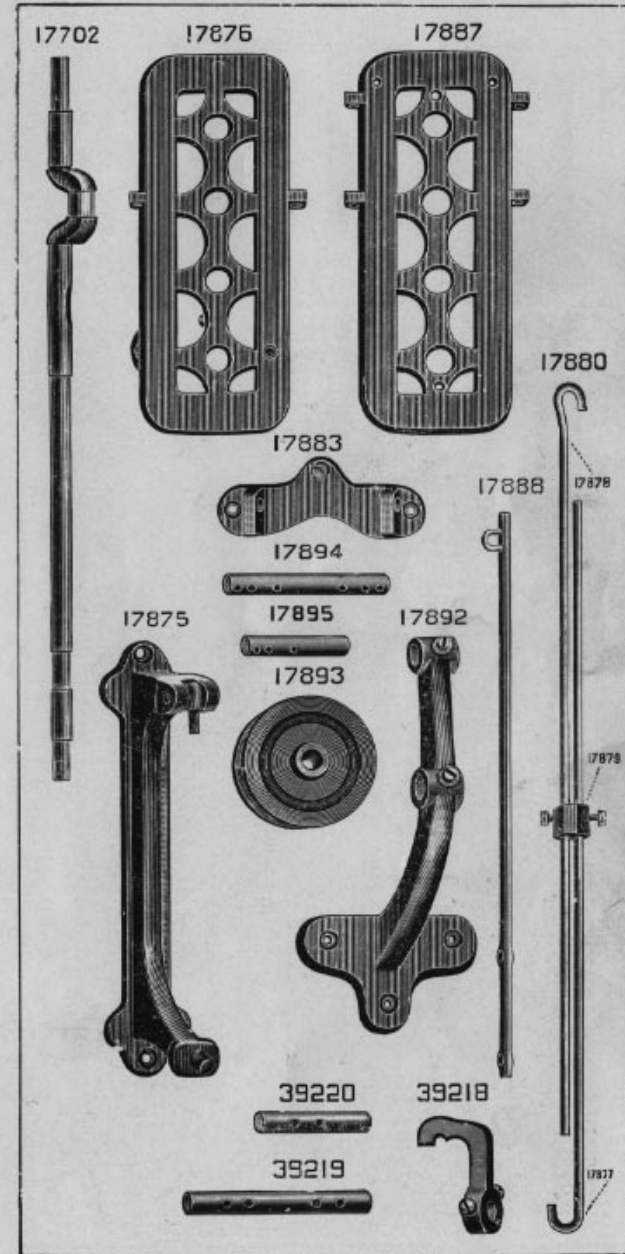

PLATE 3759—FULL SIZE

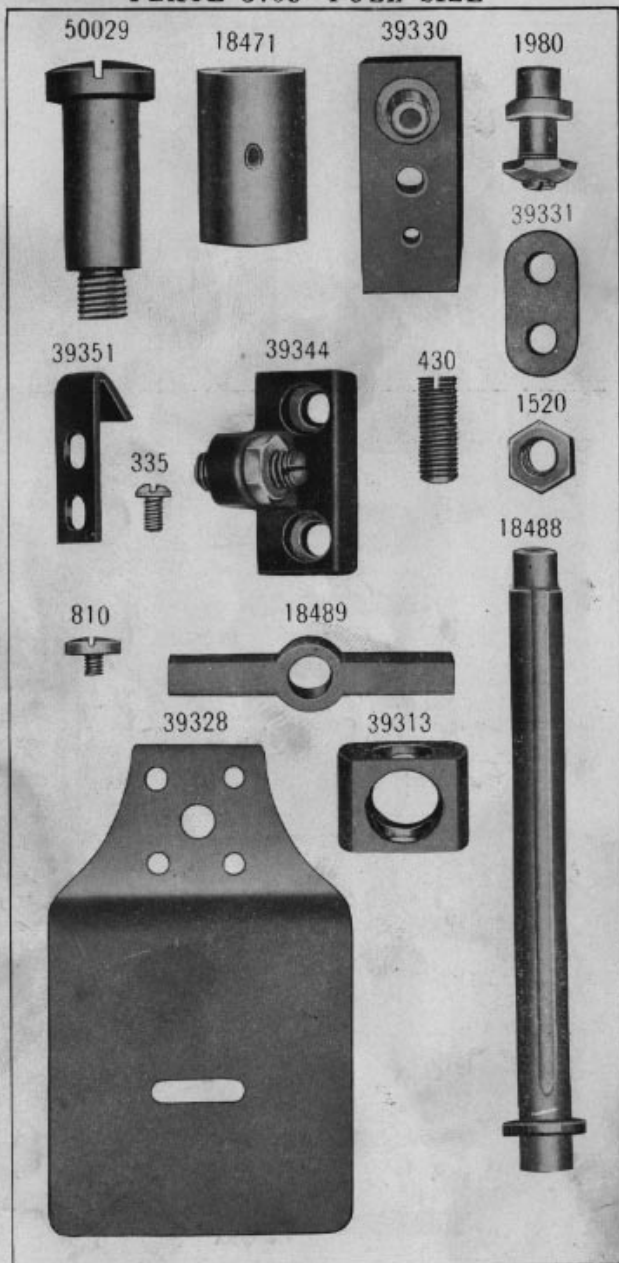

PLATE 4079—ONE-HALF SIZE

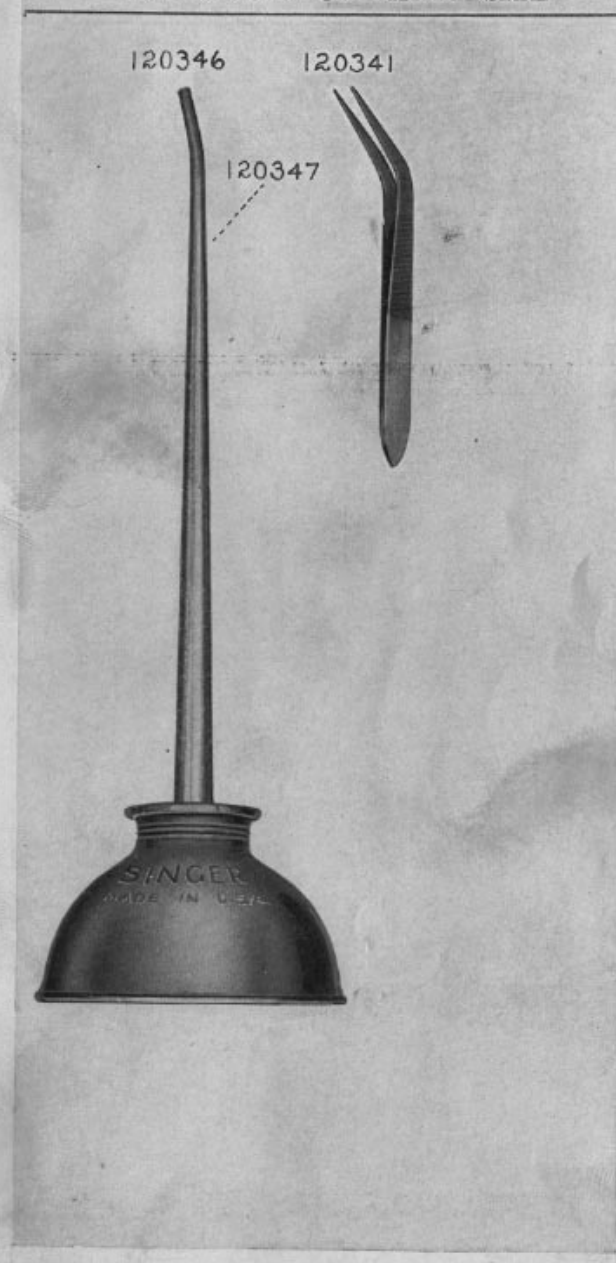

PLATE 5001—ONE-HALF SIZE

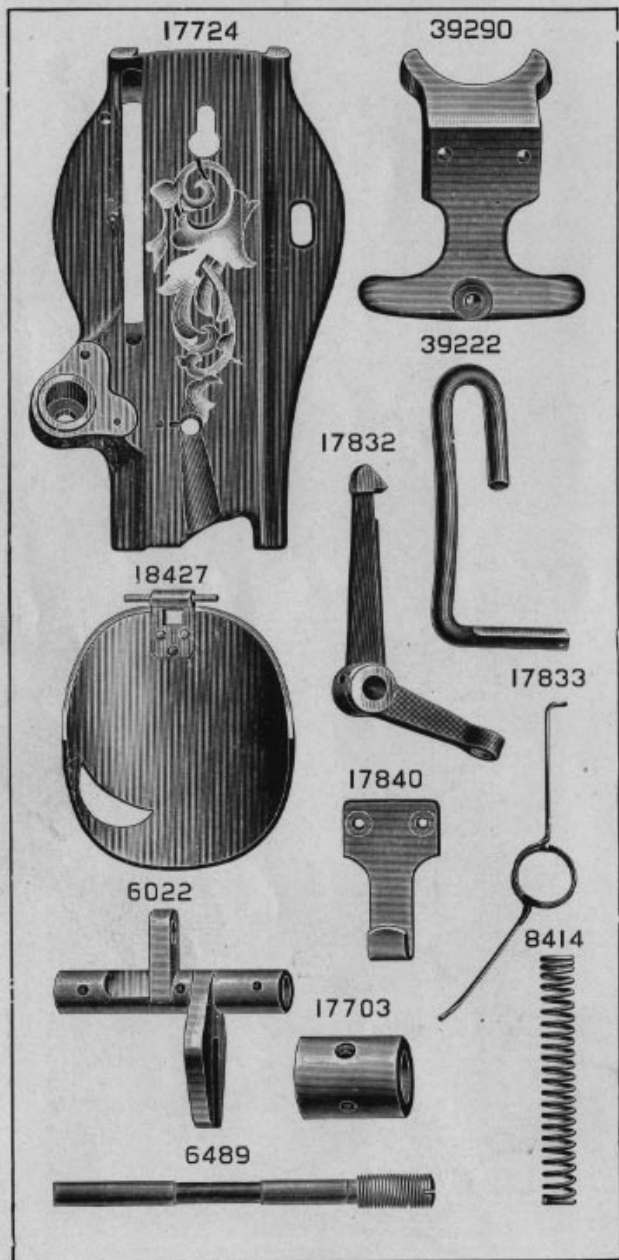

PLATE 5007—FULL SIZE

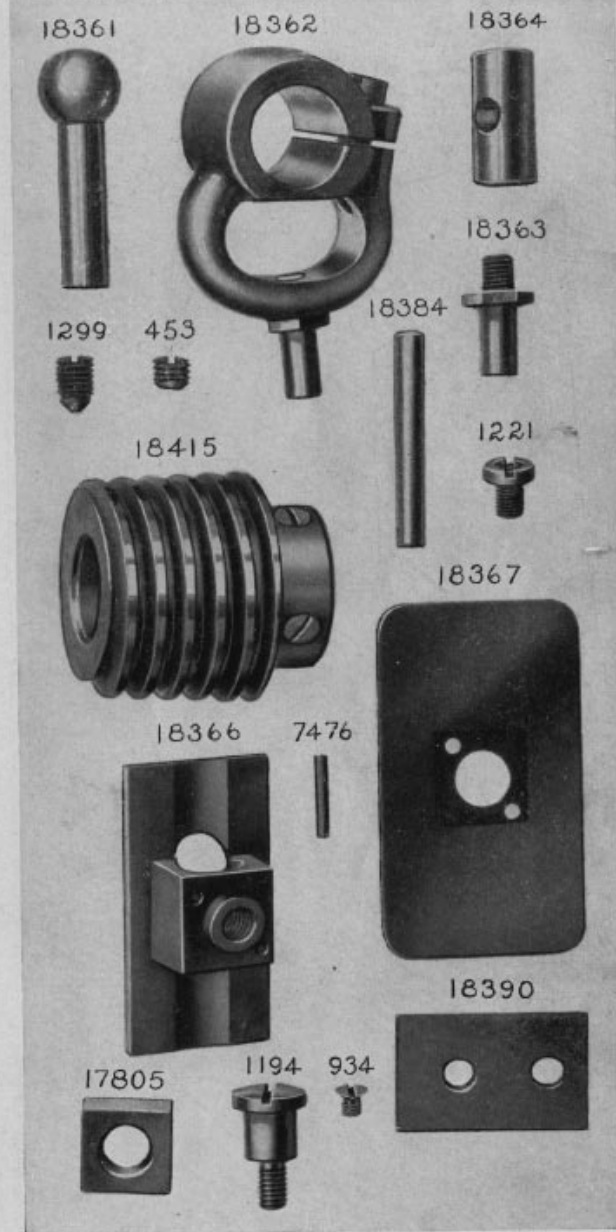

PLATE 5016—FULL SIZE

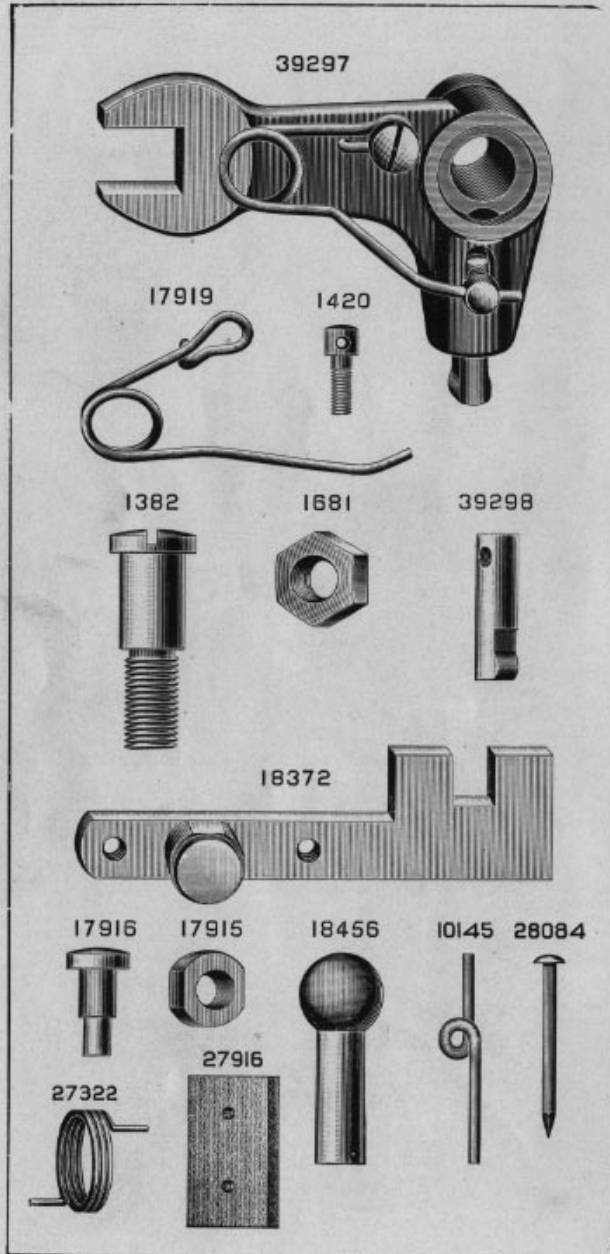

PLATE 5017—FULL SIZE

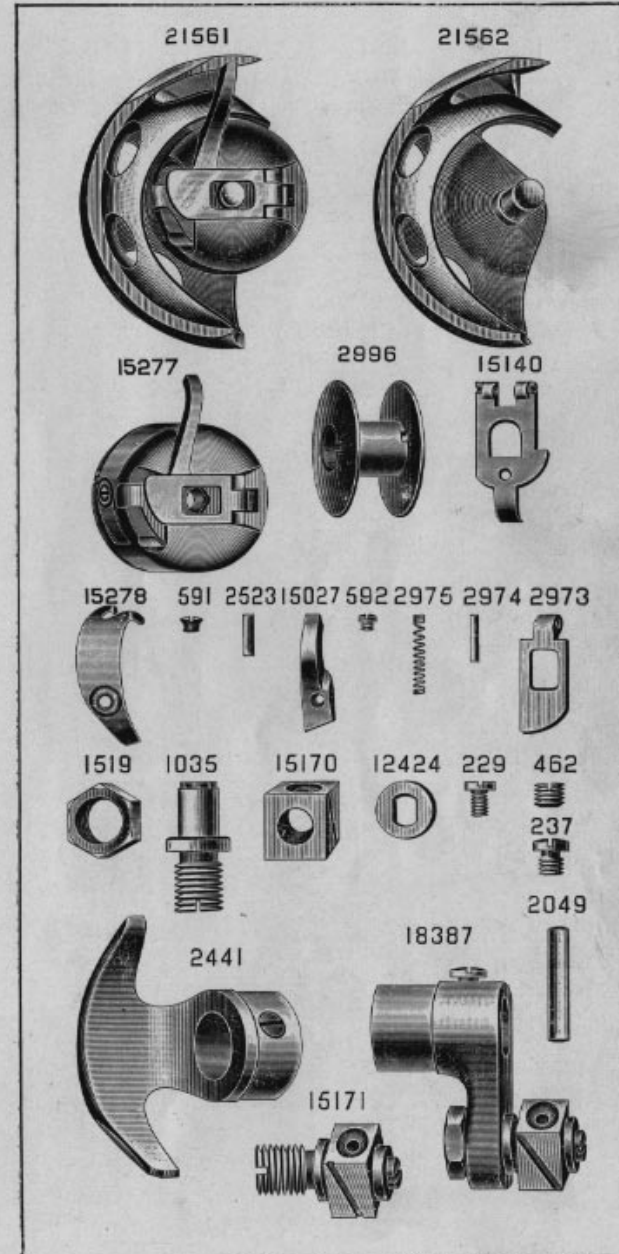

PLATE 5021—FULL SIZE

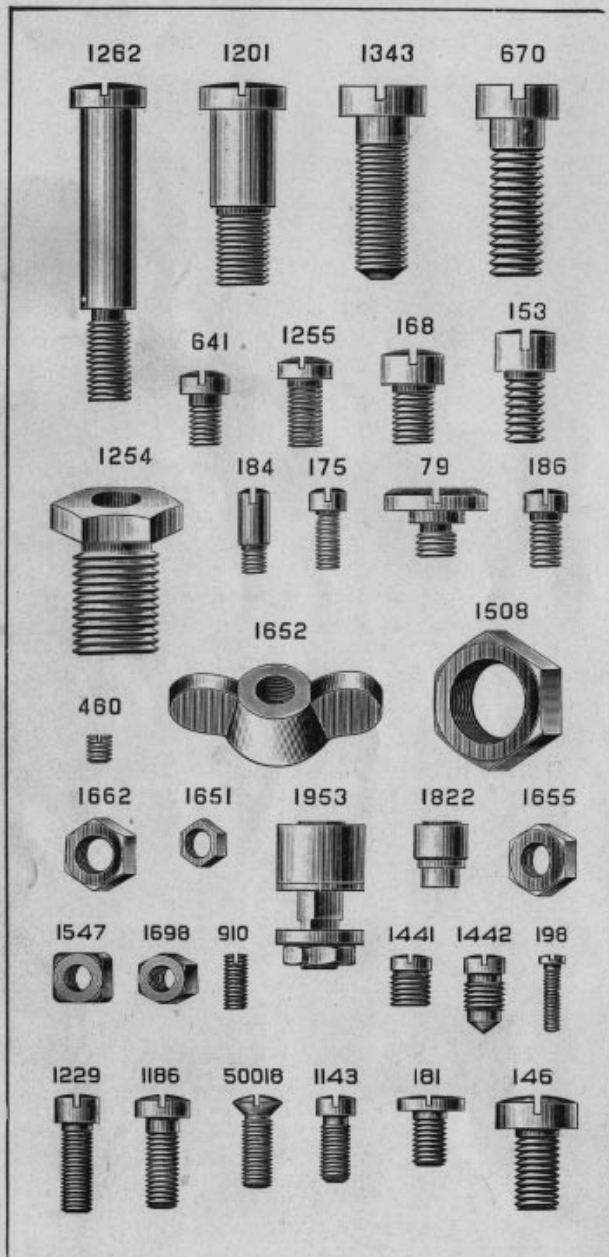

PLATE 5023—ONE-HALF SIZE

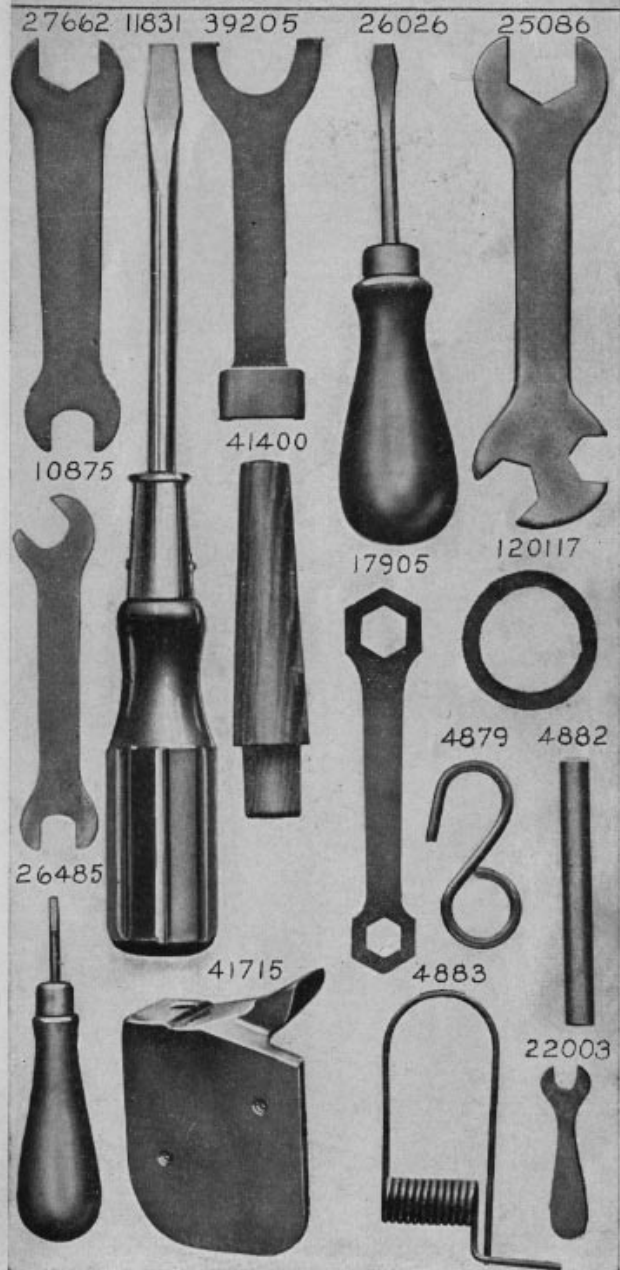
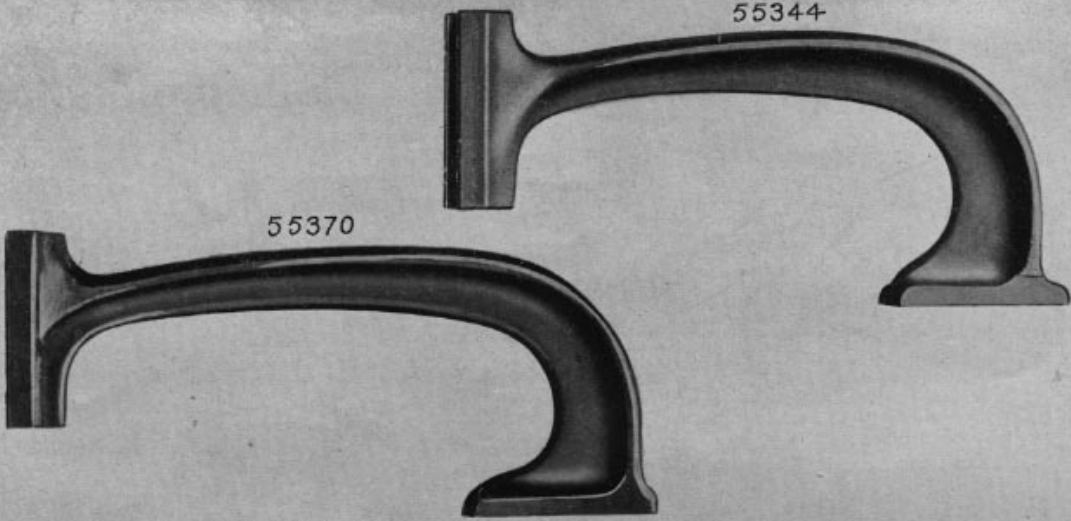



PLATE 5043—ONE-HALF SIZE



55370

55344

PLATE 5044—ONE-FOURTH SIZE

18424

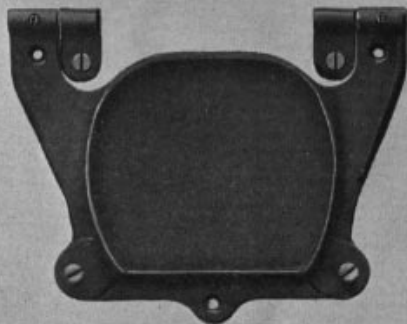

18370



18498

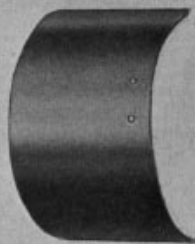

PLATE 5045—ONE-HALF SIZE

4292 17843 18392 55376 17837

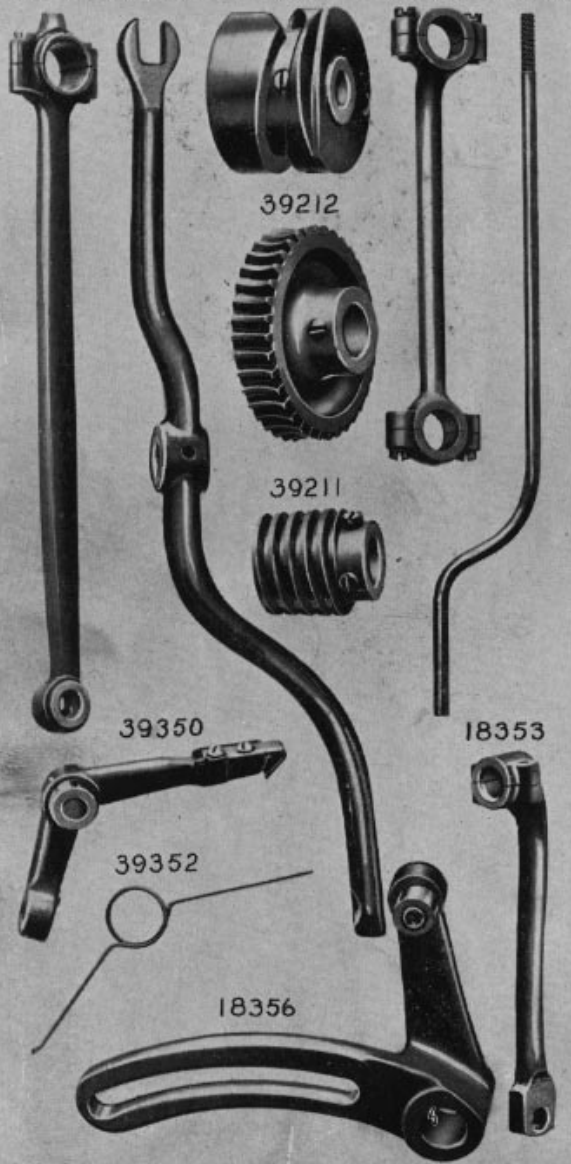

PLATE 5046—ONE-HALF SIZE

18385 18358 18437 17831 2058 17845

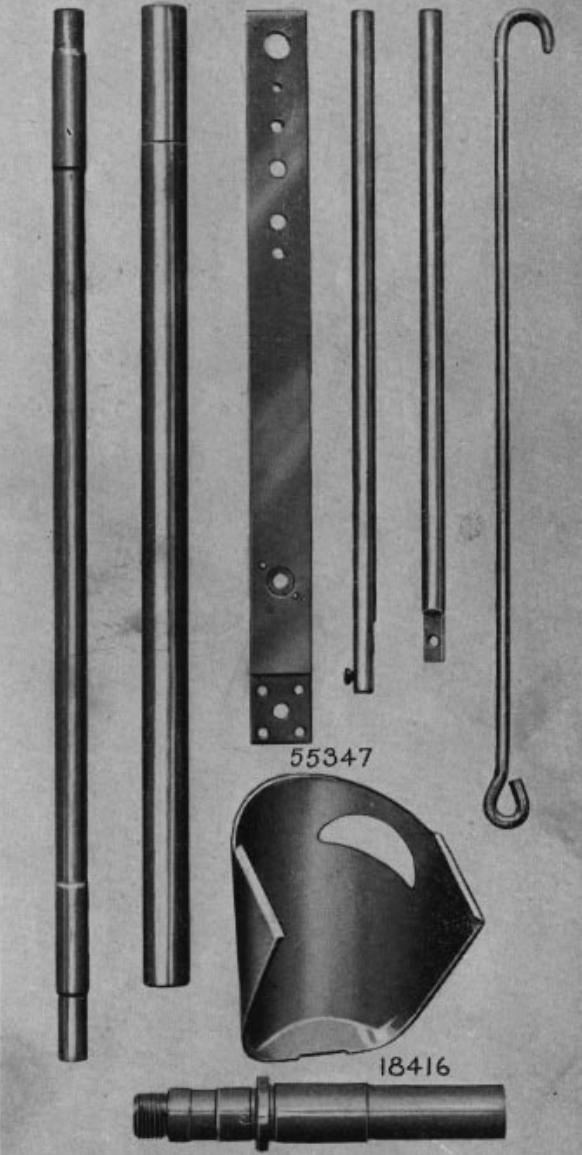

PLATE 5047—FULL SIZE

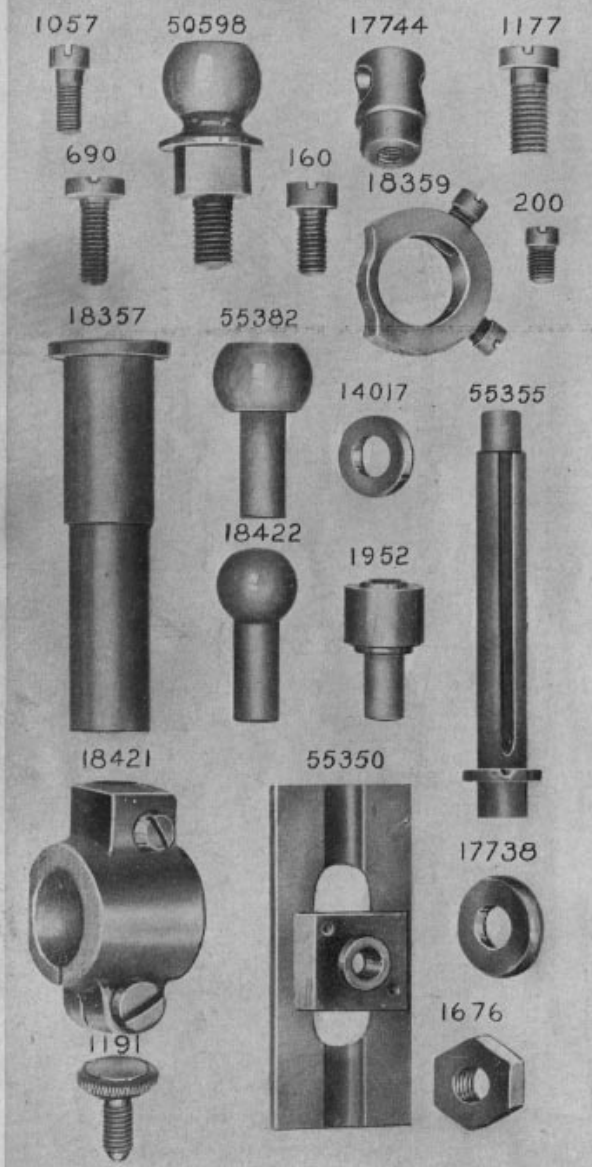

PLATE 5048—ONE-HALF SIZE

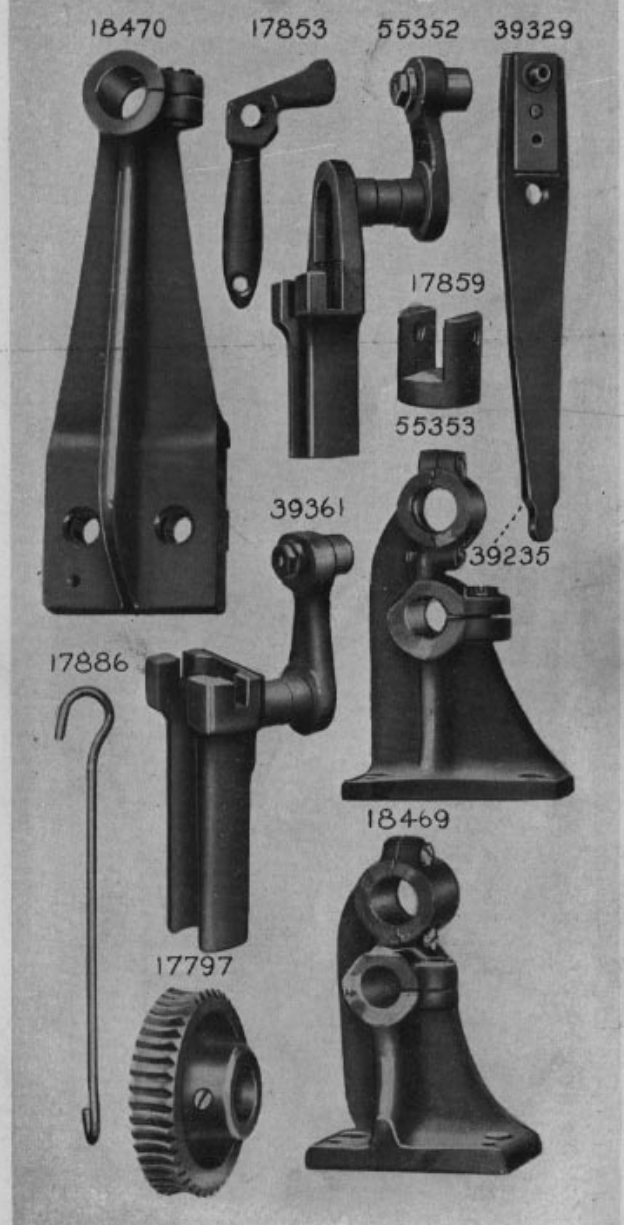
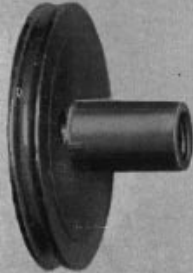

PLATE 5049—ONE-HALF SIZE

17942



17848



17941



39346



18492



39343

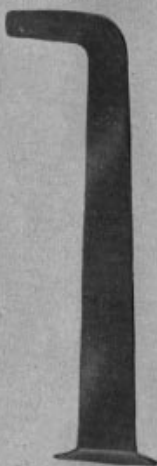

18417

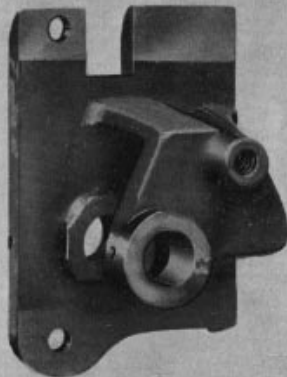

17844



18393



PLATE 5526—ONE-HALF SIZE

42002

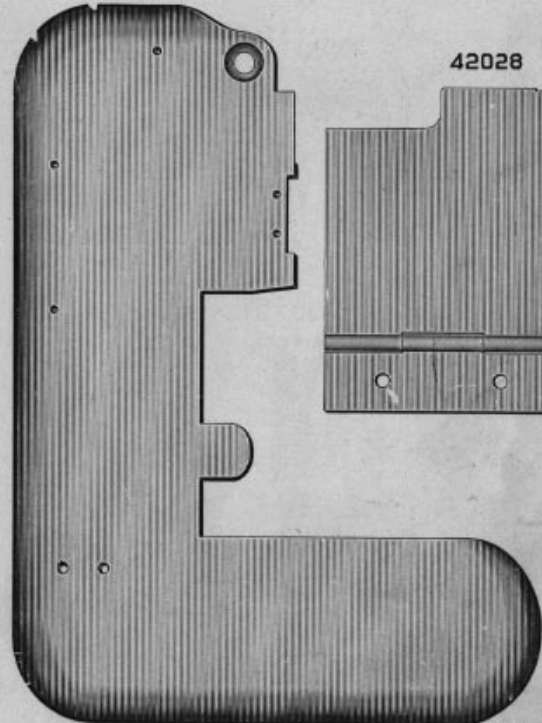

42028



42003



42108



42005



42094

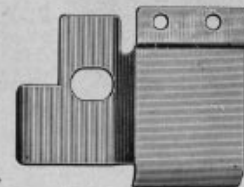

PLATE 5529—FULL SIZE

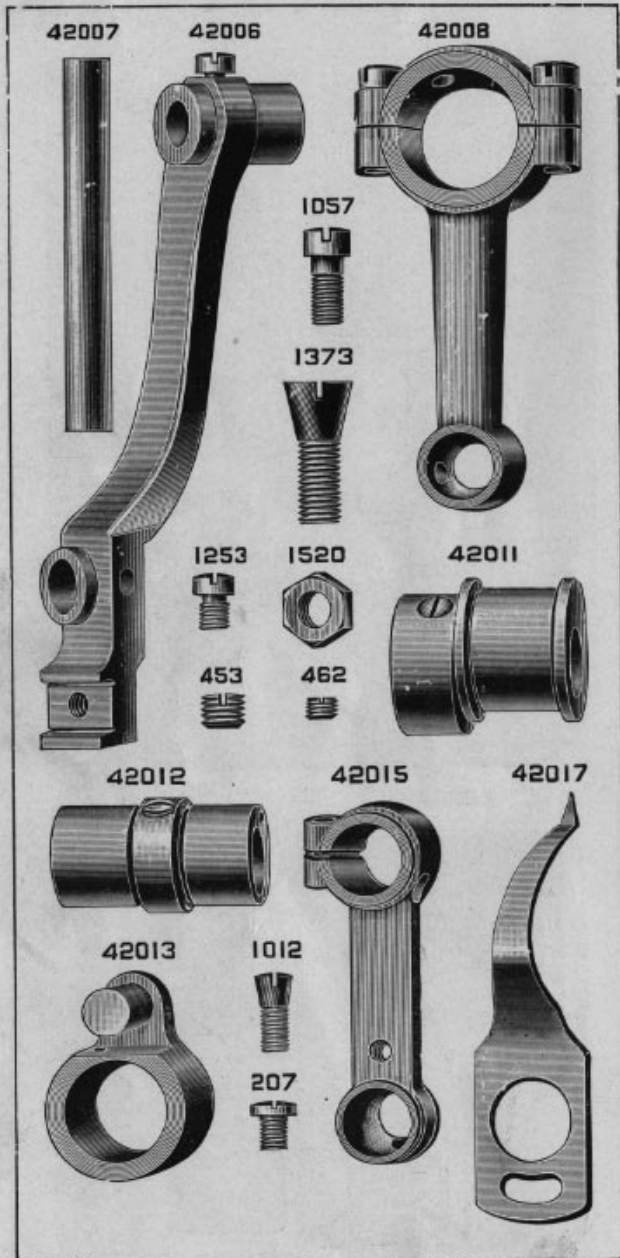

PLATE 5530—FULL SIZE

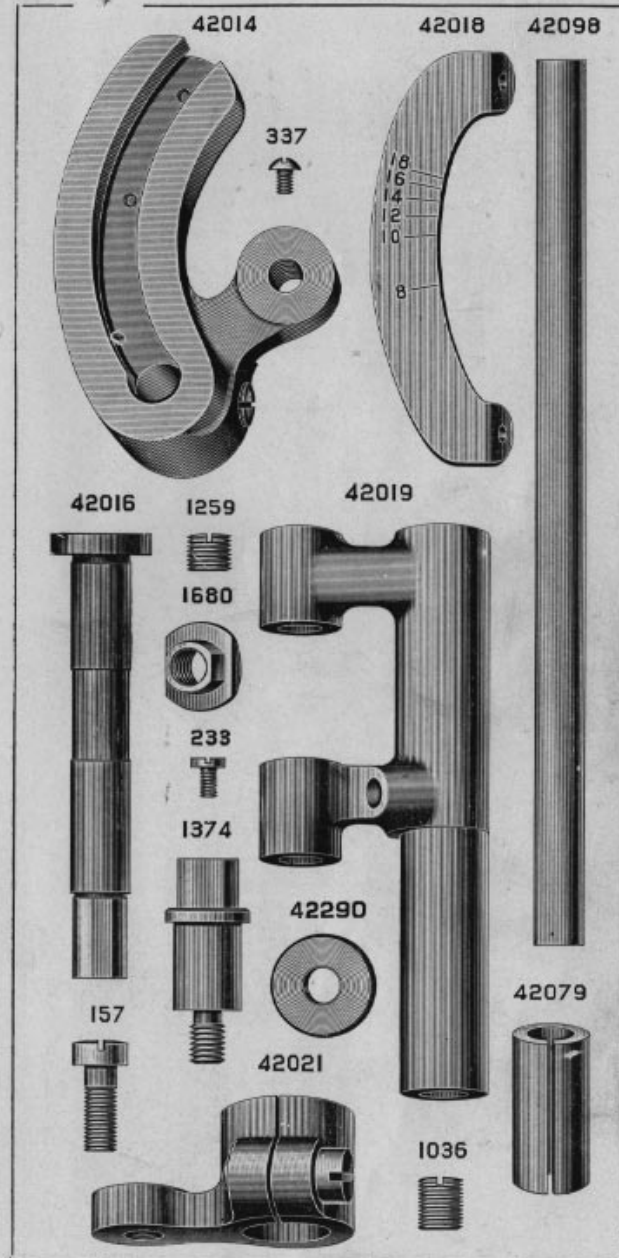

PLATE 5544--FULL SIZE



PLATE 5545--FULL SIZE

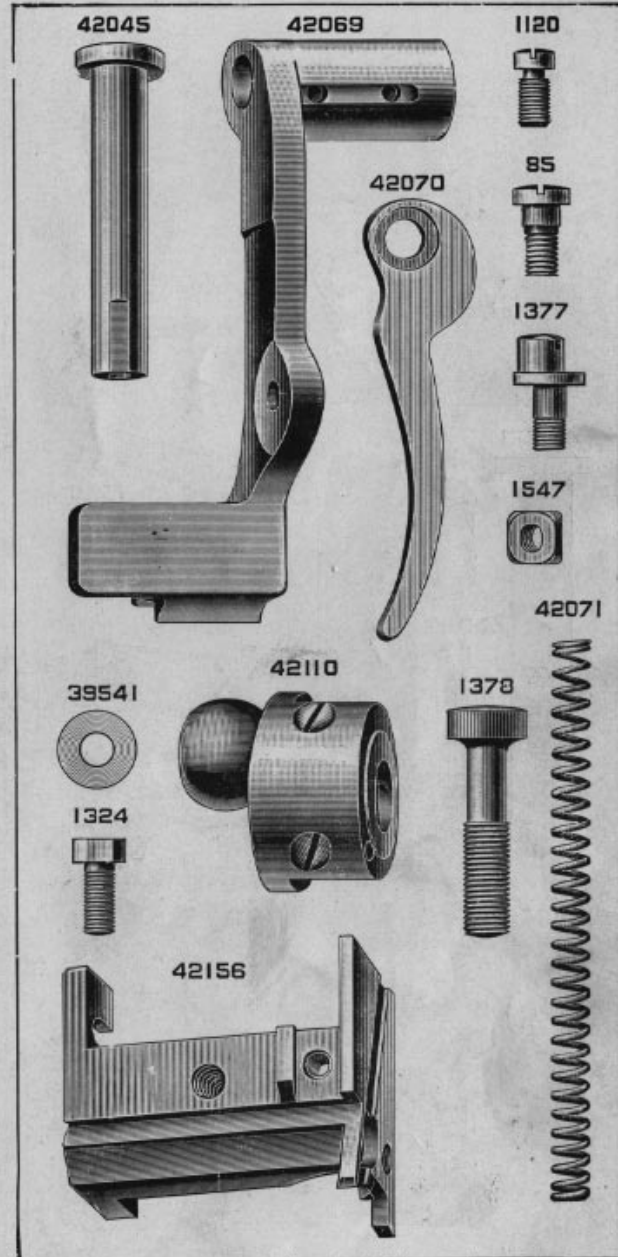

PLATE 5553—FULL SIZE

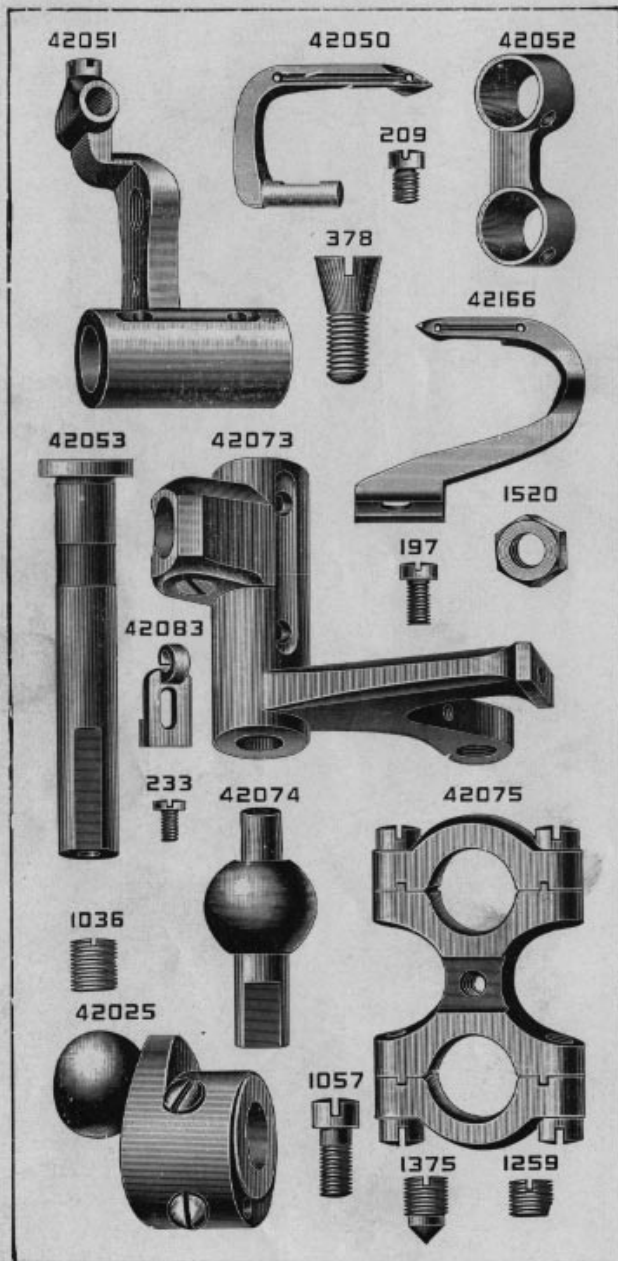

PLATE 5556—FULL SIZE

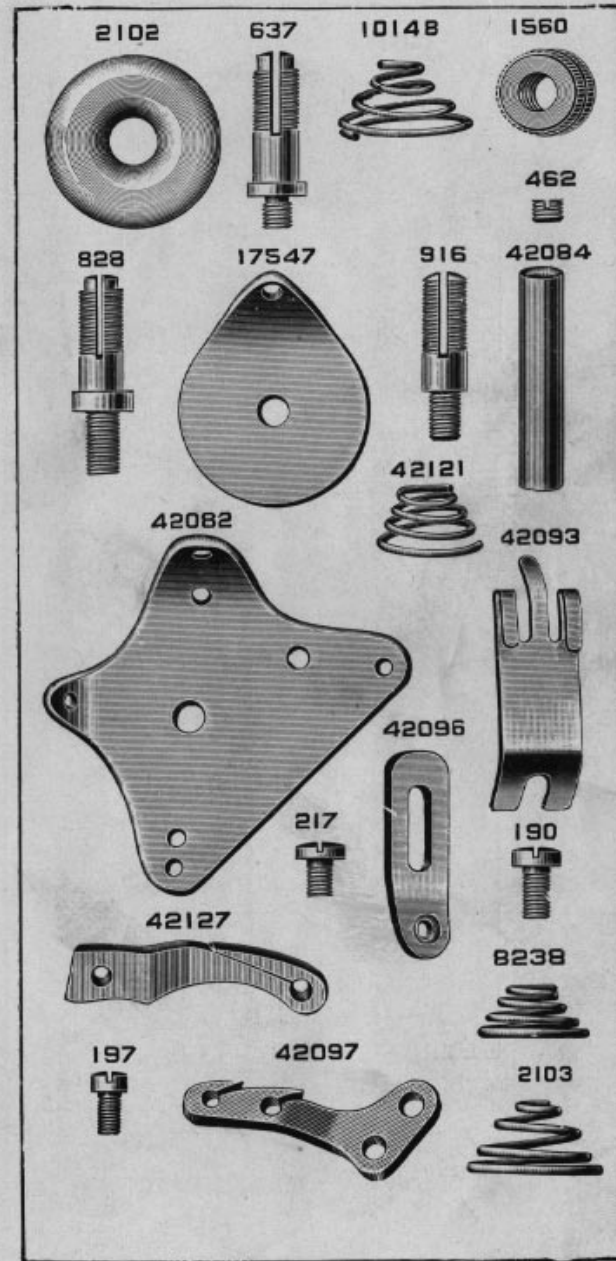



PLATE 5563—FULL SIZE

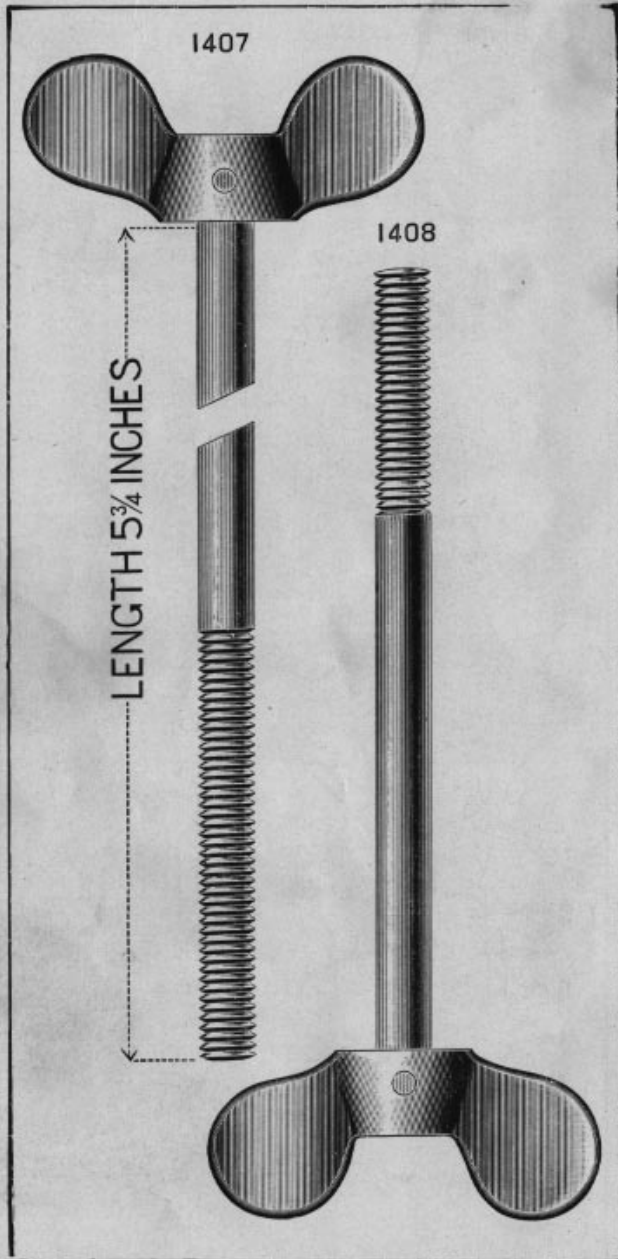

PLATE 5564—ONE-FOURTH SIZE

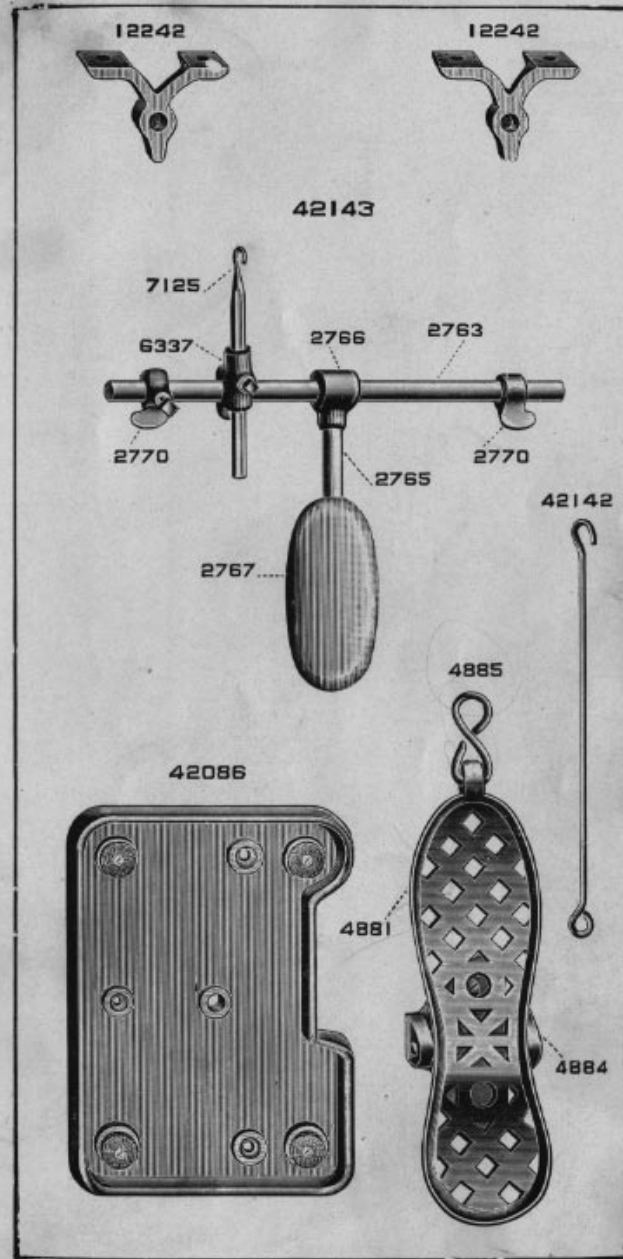

PLATE 5566—ONE-HALF SIZE

120341 120344 120440 42090

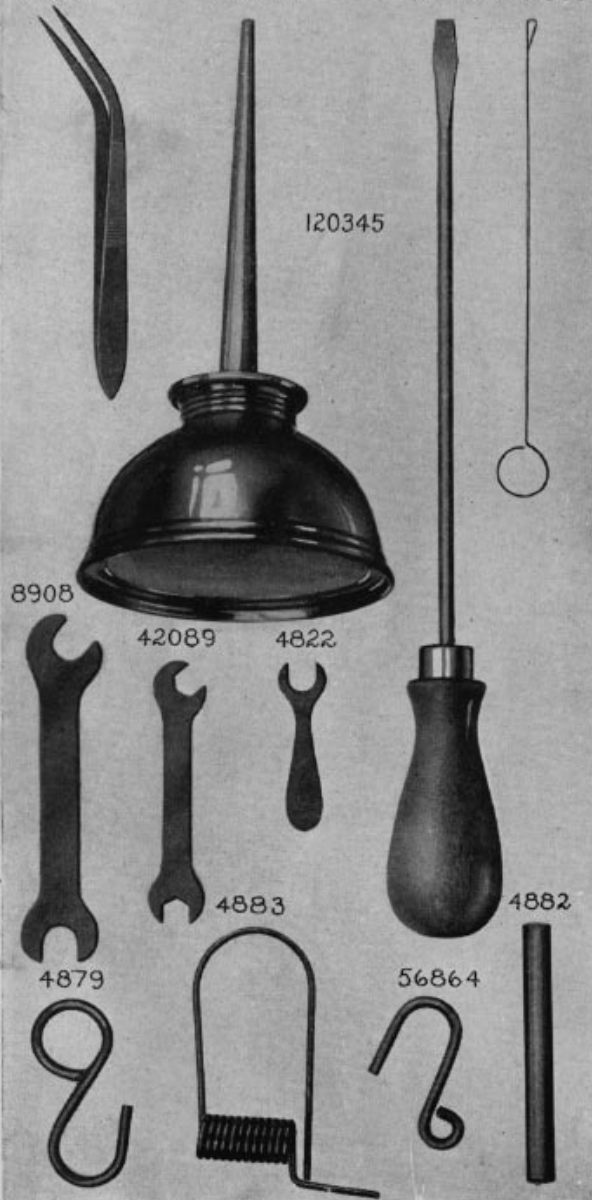

PLATE 5576—ONE-HALF SIZE

42023 42001

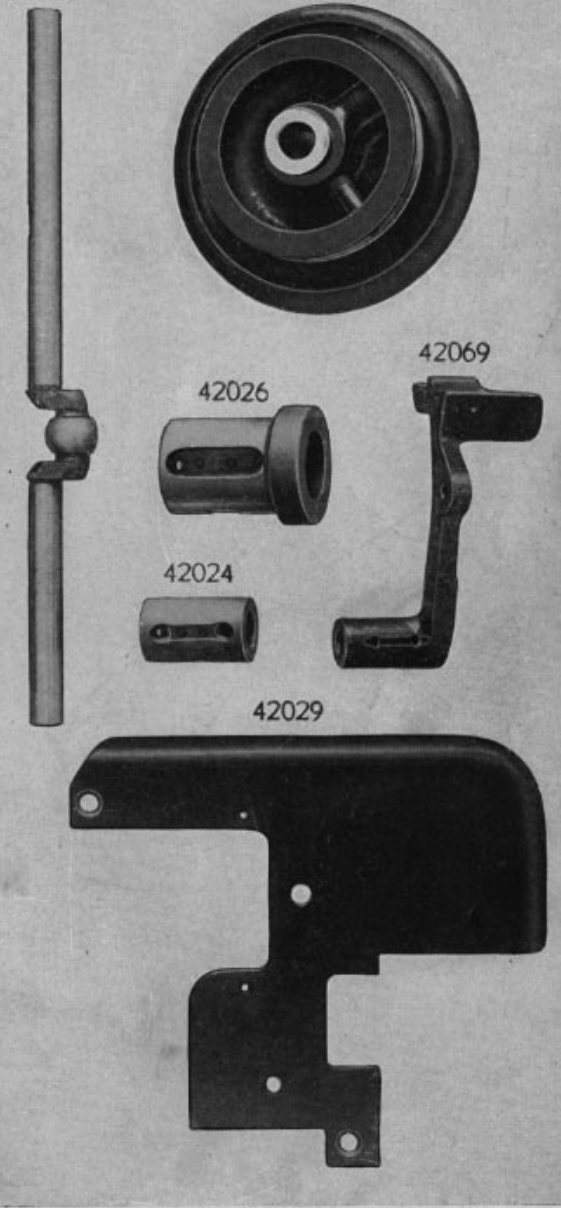

PLATE 5586—FULL SIZE



PLATE 5587—FULL SIZE

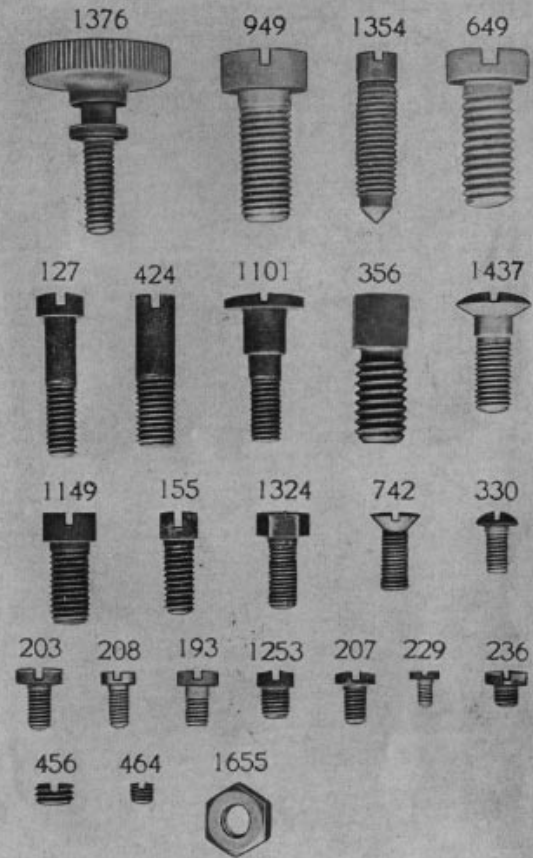

PLATE 5588—FULL SIZE

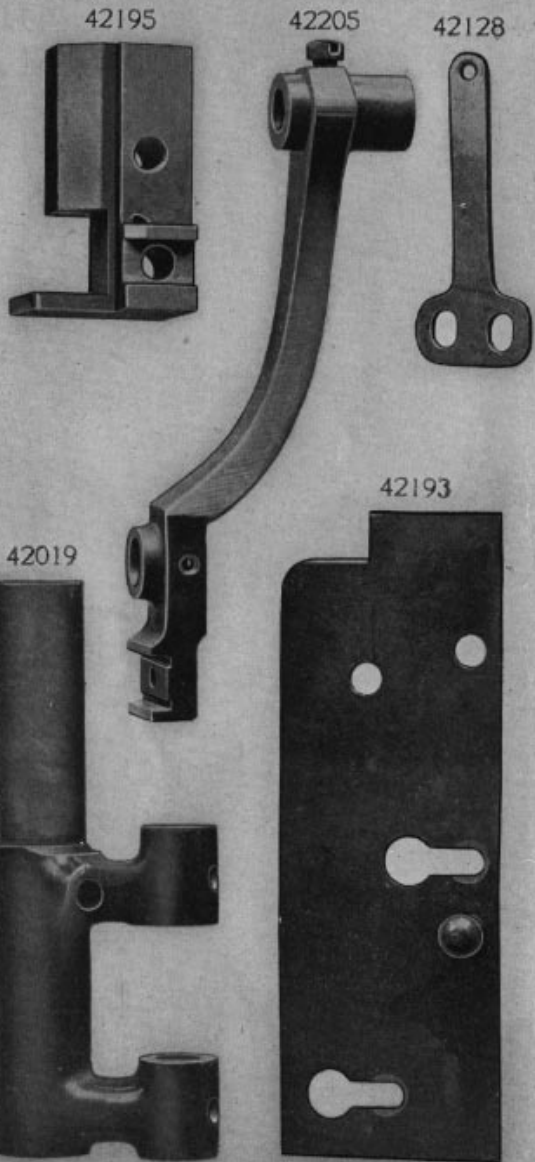

PLATE 7008—ONE-HALF SIZE

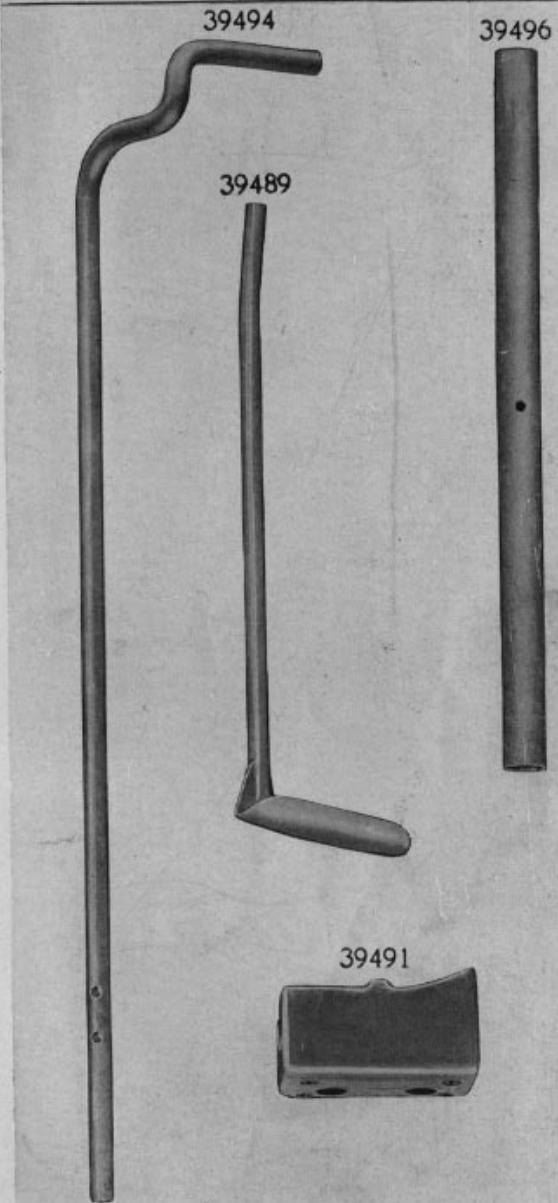

PLATE 7009—FULL SIZE

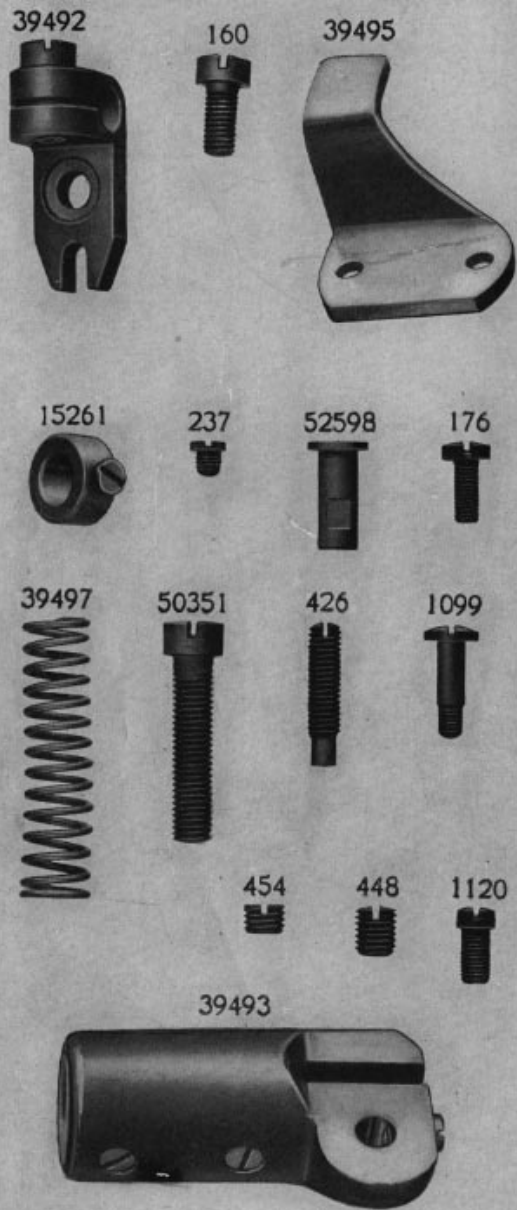

PLATE 7165—ONE-FOURTH SIZE

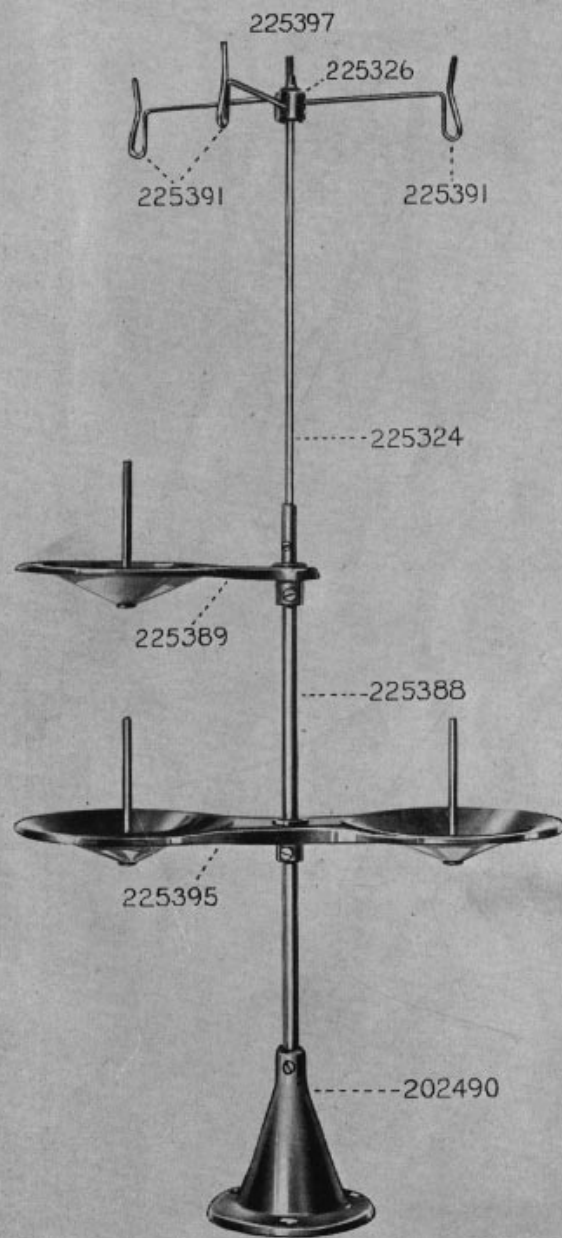

PLATE 7219—ONE-EIGHTH SIZE

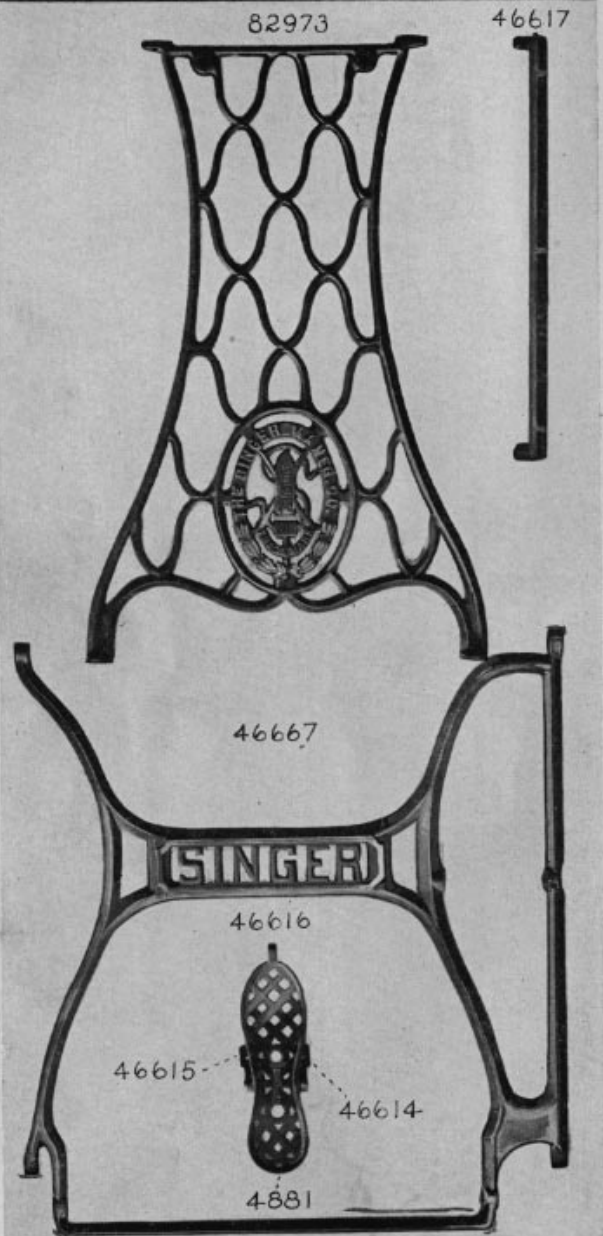
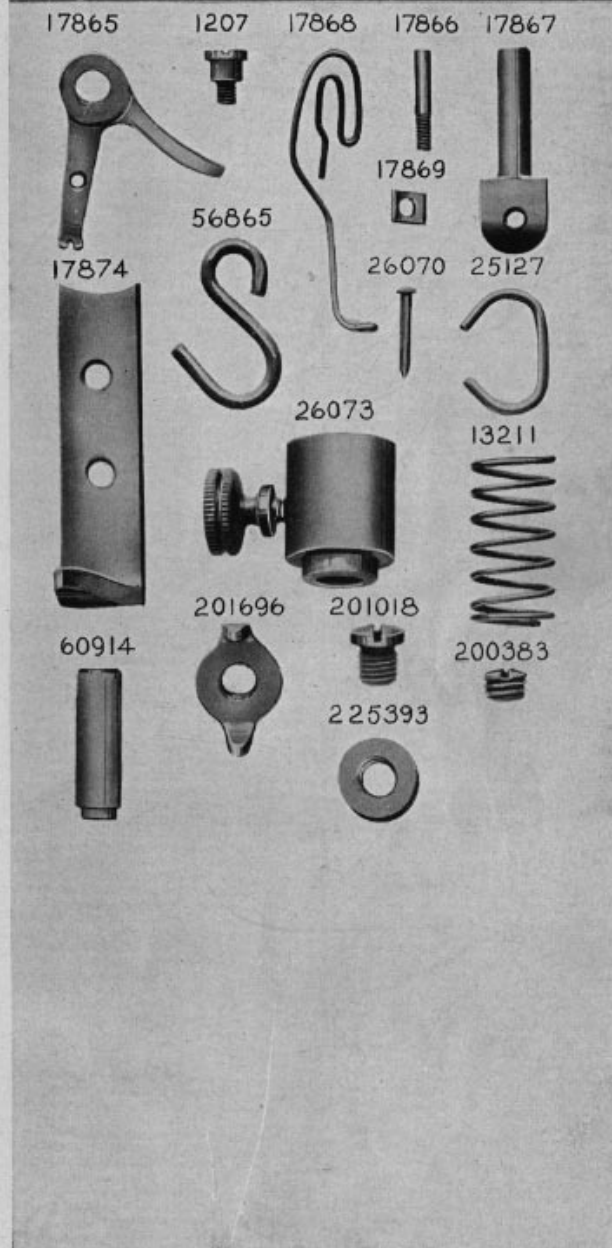
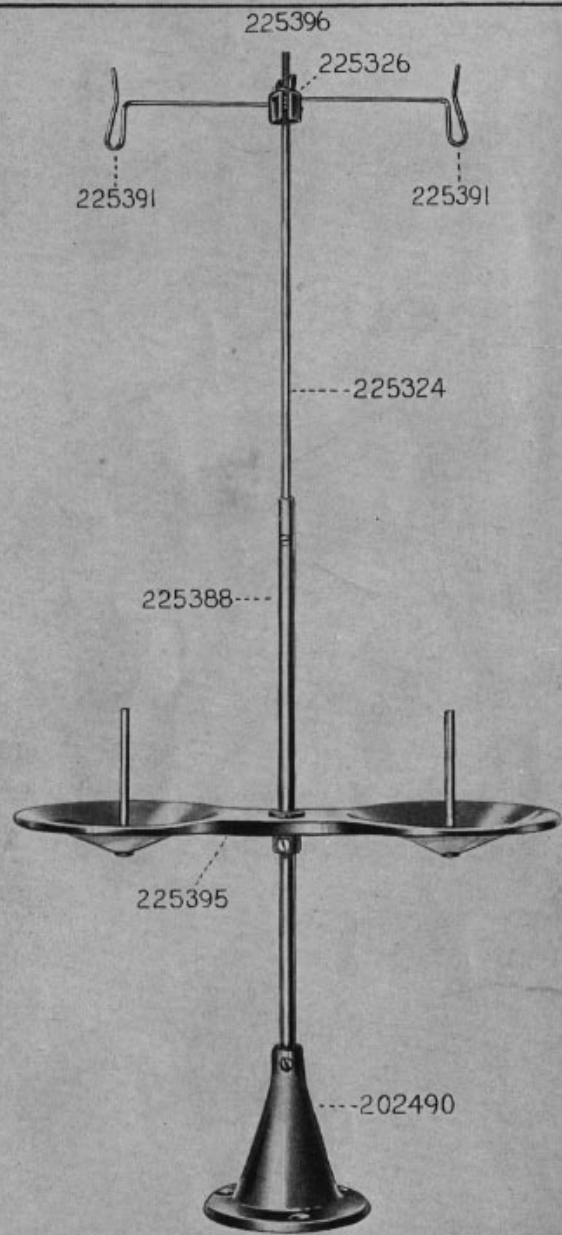

PLATE 7229—FULL SIZE



**PLATE 7233—ONE-FOURTH SIZE**



**PLATE 7234—ONE-HALF SIZE**

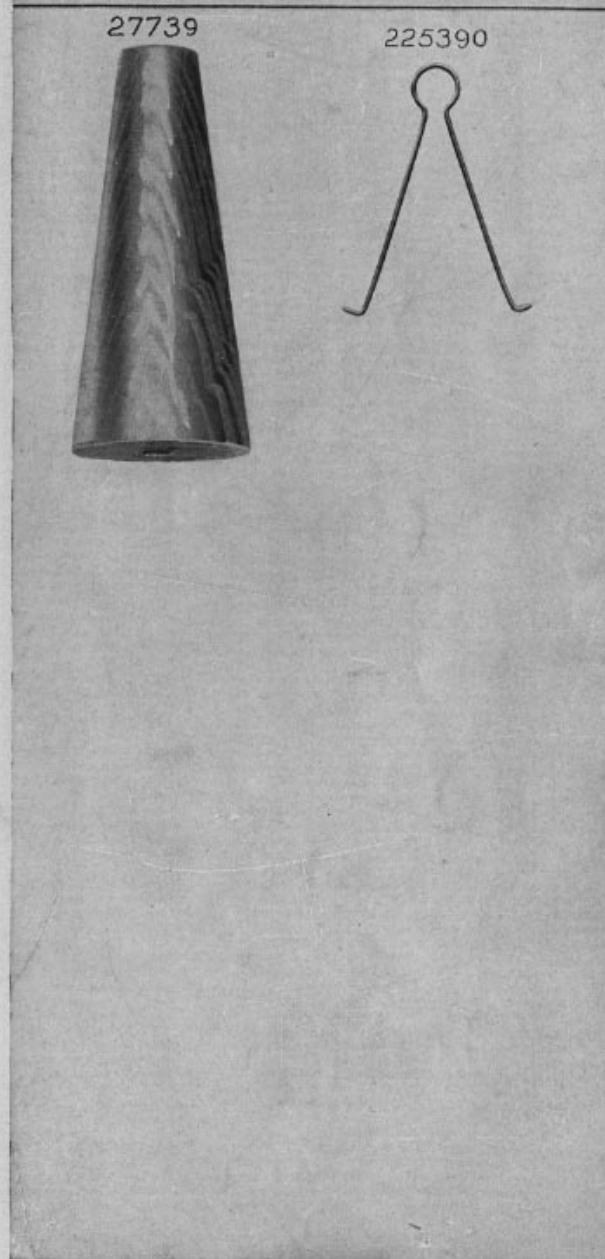

PLATE 7394—FULL SIZE



PLATE 7395—FULL SIZE

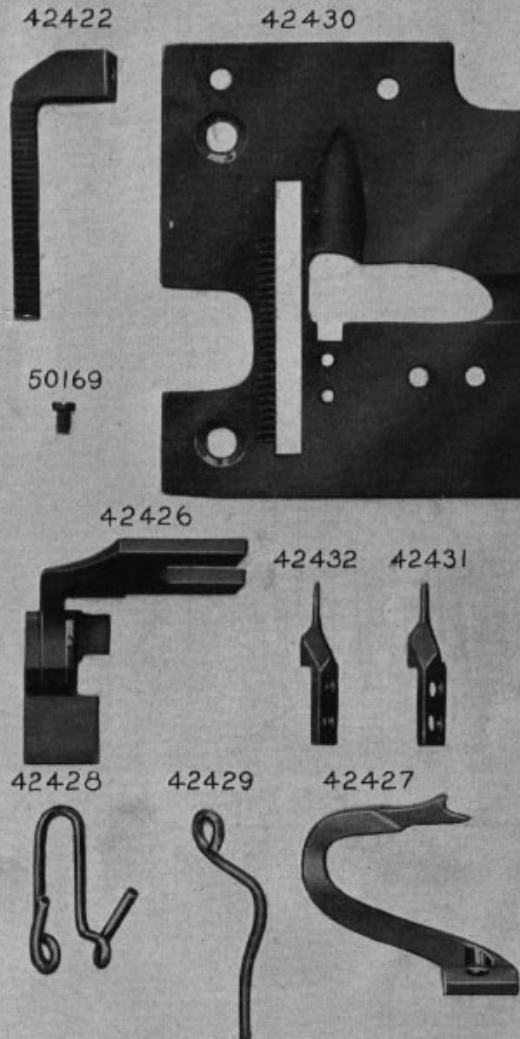



PLATE 8575—FULL SIZE

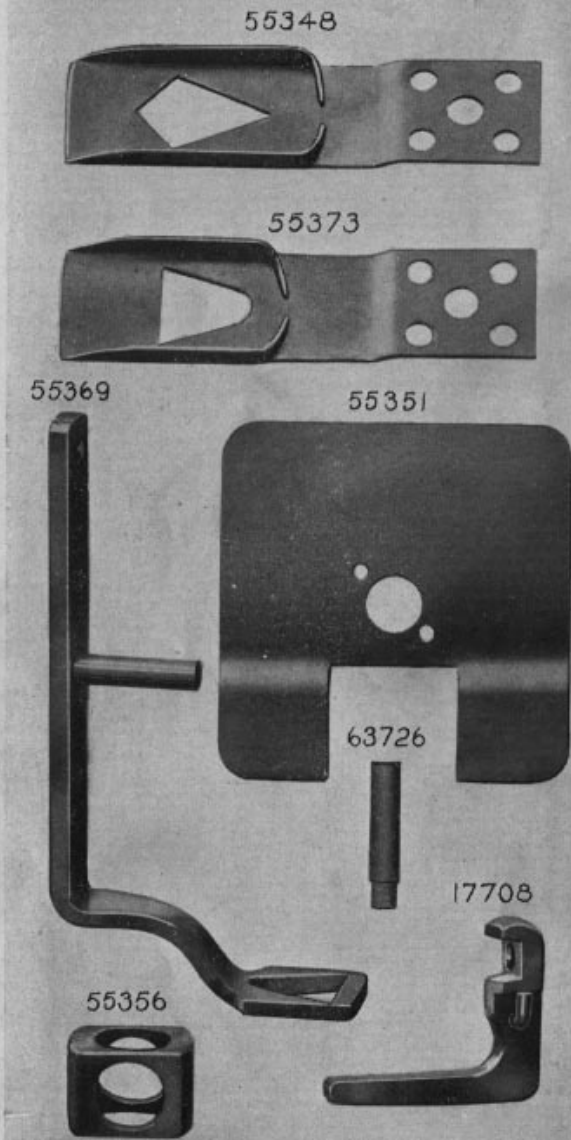

PLATE 8576—FULL SIZE

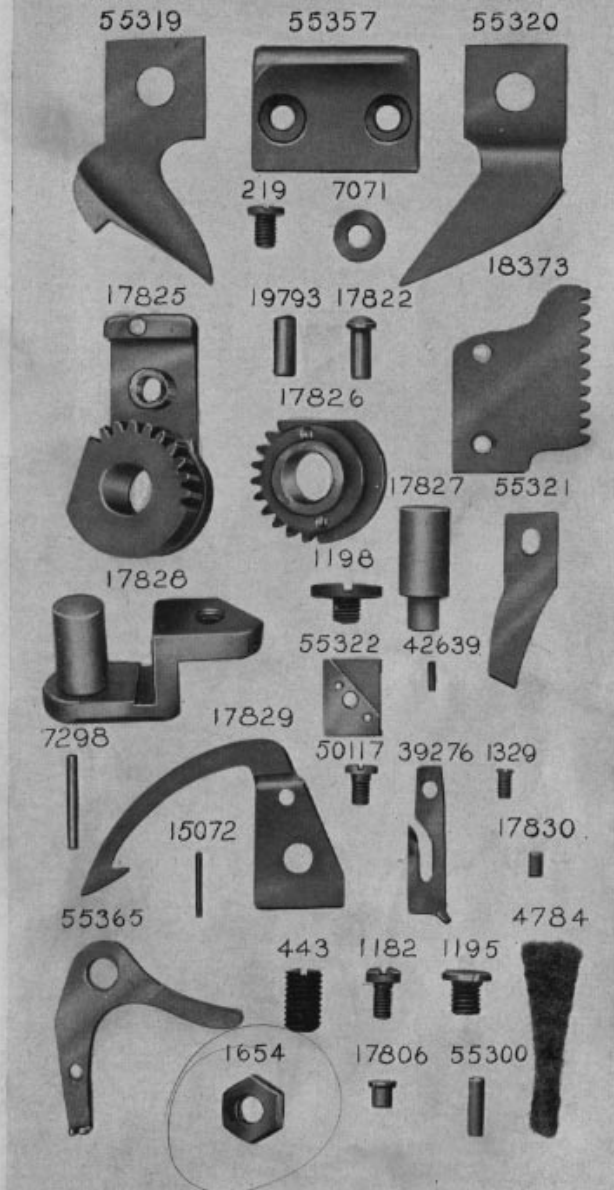
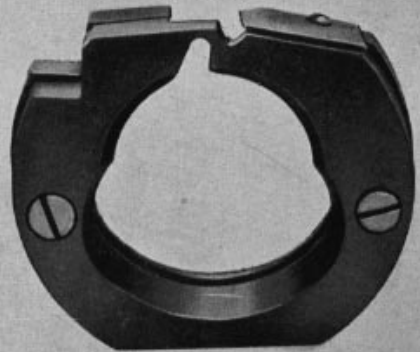

PLATE 8577—FULL SIZE

55364



1289



18413



171



662



55363

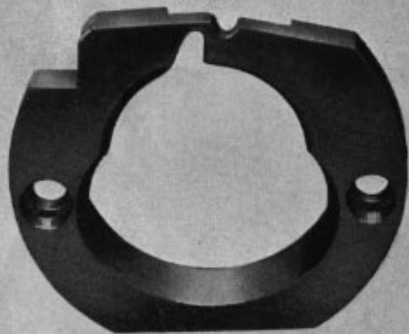

21623



55359



55360



PLATE 8578—FULL SIZE

55367

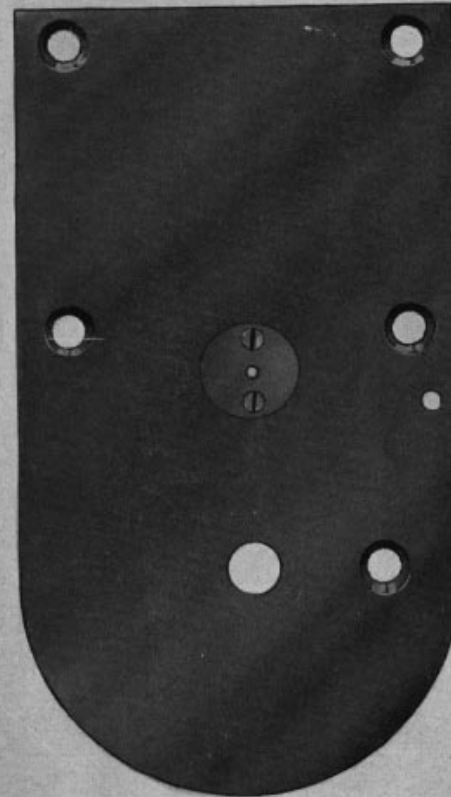

1208



55326



PLATE 8579—ONE-HALF SIZE

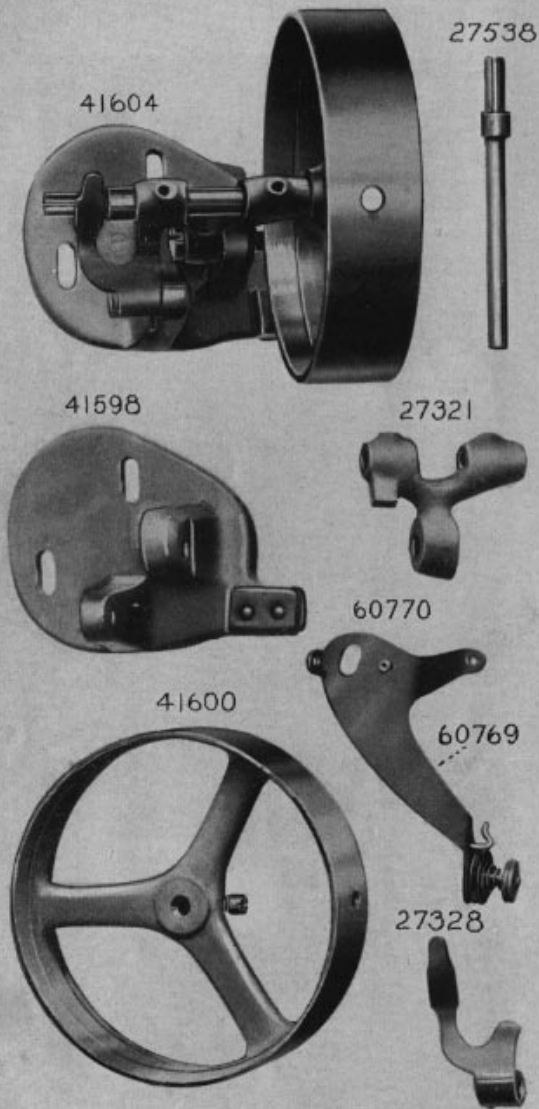

PLATE 8580—FULL SIZE

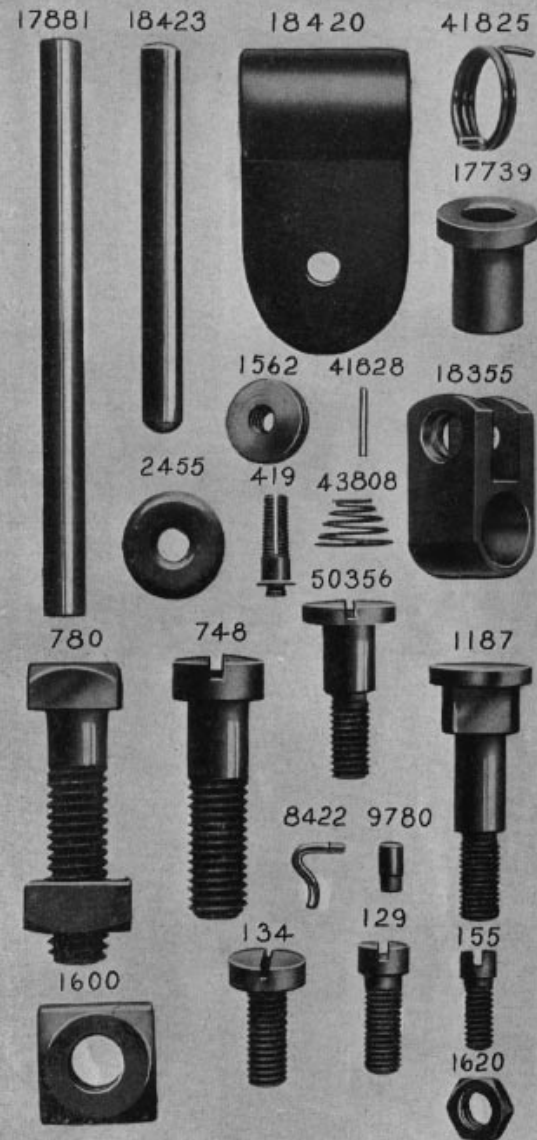
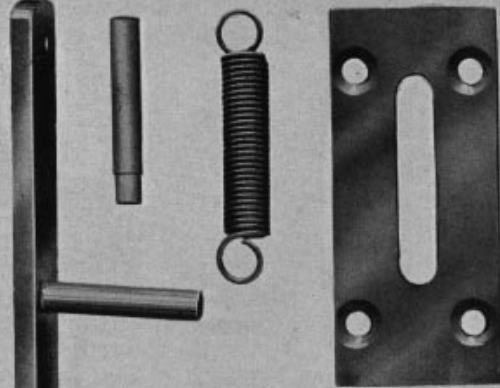

PLATE 8581—FULL SIZE

55341 55342 39303 55343



1175 14079 4389



50333 1318 17960



39223 39206

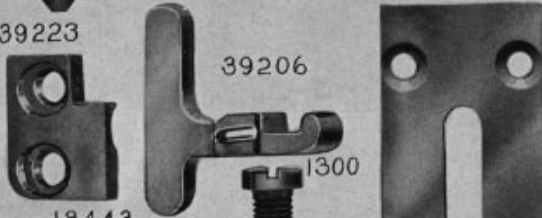

18443 1300 18388

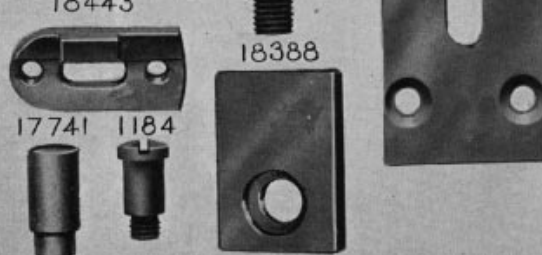

17741 1184

