

Form 18158 Revised
July, 1930
PRINTED IN U. S. A.

LIST
OF
PARTS



MACHINES

Nos. 92-1 to 92-6

THE SINGER MANUFACTURING COMPANY

COPYRIGHT, U. S. A., 1914, 1916, 1917, 1922 and 1926
BY THE SINGER MANUFACTURING COMPANY
ALL RIGHTS RESERVED FOR ALL COUNTRIES

INDEX

	PAGE
ACCESSORIES.....	54
EDGE FOLDERS.....	54
FOOT LIFTER PARTS.....	55
HEMMER.....	55
KNEE LIFTER PARTS.....	56
MACHINE BASE.....	56
" No. 92-1.....	7
" " 92-2.....	15
" " 92-3.....	22
" " 92-4.....	31
" " 92-5.....	39
" " 92-6.....	47
NUMERICAL LIST OF PARTS.....	59
THREAD UNWINDER.....	57

INSTRUCTIONS FOR ORDERING

In ordering from this list, use ONLY the part NUMBER in the FIRST column.

The number stamped on a Sewing Machine part is in every case the number of the single part only.

Every combination of parts sent out as such has its specific number, which, although not stamped on the parts, must be used when ordering the combination.

Each number always indicates the SAME PART in whatever list it appears, or for whatever machine.

The letters after some of the numbers indicate the style of finish only, as follows:

- A—Hardened, Polished, Nickel Plated and Buffed
- B—Polished, Nickel Plated and Buffed
- C—Hardened Only
- D—Polished Only
- E—Soft, Not Polished
- F—Hardened and Polished
- H—Blued
- J—Nickel Plated Only
- K—Hardened and Nickel Plated
- L—Brass Plated
- M—Oxidized
- N—Japanned, Dull
- P—Japanned, Bright
- R—Merlized
- T—Copper Plated
- T. A.—Hardened, Polished, Copper and Nickel Plated and Buffed
- T. B.—Copper and Nickel Plated and Polished
- T. J.—Copper and Nickel Plated Only
- T. K.—Hardened, Copper and Nickel Plated
- T. M.—Copper Plated and Oxidized
- T. L.—Copper and Brass Plated
- U—Zinc Plated
- V—Silver Plated
- W—Polished and Nickel Plated
- Z—Chromium Plated
- Z. B.—Polished, Nickel Plated, Buffed and Chromium Plated
- Z. J.—Nickel and Chromium Plated

These letters MUST BE USED when they appear in the list; and AFTER the number as in the list.

In this series:

- 1 to 1500 and 50001 to 51500 are Screw Numbers
- 1501 to 1800 and 51501 to 51800 are Nut Numbers
- 1801 to 2000 and 51801 to 52000 are Roller Numbers
- 2001 to 50000 and 52001 and upward are numbers of Machine Parts

The figures in the second column refer only to the plates, illustrating the parts, and are NOT TO BE USED in ordering.

Parts marked with an asterisk (*) are furnished only when repairs are made at factory.

LIST OF PARTS COMPLETE

FOR

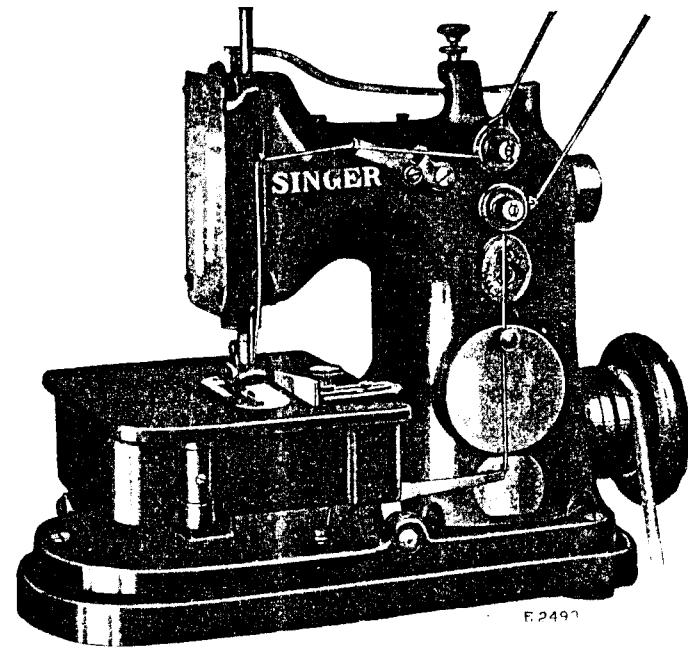

MACHINE No. 92-1

FOR BAG WORK. STITCH FROM 1/6 TO 1/3 INCH LONG. HAS ONE NEEDLE, ONE LOOPER AND THROAT PLATE FOR SINGLE THREAD; ALSO LOOPER AND THROAT PLATE FOR TWO-THREAD CHAIN STITCH.

NO.	PLATE	NAME
*49001	---	Arm, upper and lower (solid).....
18130	6205	" " Oil Tube with 52045, for front bearing.....
18130	6205	Arm Oil Tube with 52045, for intermediate bearing.....
11119	6205	Arm Oil Tube with 52045, for oiling 49101
18130	6205	" " " " 52045, for oiling 49049
49091	6205	" " " " 49092, for oiling 49265 (lower bearing).....

NO.	PLATE	NAME
49141	6213	Arm Oil Tube with 56006, for oiling 49265 (upper bearing).....
52045	6197	Arm Oil Tube Packing (braided cotton) for 11119 and 18130.....
56006	6197	Arm Oil Tube Packing (braided cotton) for 49141.....
49092	6205	Arm Oil Tube Packing (felt) for 49091....
49156	6207	" Rock Shaft.....
49271	—	" " " 49156 with 49261.....
49003	6208	" " " Bushing (back).....
446c	6208	" " " " " Set Screw
49004	6208	" " " " (intermediate)
446c	6208	" " " " " " Set Screw.....
49006	6208	Arm Rock Shaft Collar with two 443c....
443c	6208	" " " " " Set Screw.....
49261	6219	" " " Crank(back)with50282E and 50457c.....
50457c	6219	Arm Rock Shaft Crank (back) Position Screw.....
50282E	6208	Arm Rock Shaft Crank (back) Set Screw
49262	6219	" " " " (front) with 50282E and 50457c.....
50457c	6219	Arm Rock Shaft Crank (front) Position Screw.....
50282E	6208	Arm Rock Shaft Crank (front) Set Screw
49005	6208	" " " Flanged Bushing (front)
430c	6208	" " " " " " Set Screw.....
49084	6181	Arm Rock Shaft Oil Cover.....
193D	6181	" " " " " " Screw.....
49097	6207	" Rotary Shaft.....
49263	—	" " " 49097 with 49266.....
49011	6181	" " " Bushing (front).....
430c	6208	" " " " " " SetScrew
49010	6209	" " " Collar with two 1259c
1259c	6209	" " " " " Set Screw.....
49012	6179	" " " Flanged Bushing (back) with 49013 and 49093.....
49093	6205	Arm Rotary Shaft Flanged Bushing (back) Oil Pad (long) braided cotton.....
49013	6205	Arm Rotary Shaft Flanged Bushing (back) Oil Pad (short) braided cotton.....
159F	6198	Arm Rotary Shaft Flanged Bushing (back) Screw.....
49014	6181	Arm Rotary Shaft Flanged Bushing (intermediate).....

NO.	PLATE	NAME
448c	6181	Arm Rotary Shaft Flanged Bushing (intermediate) Set Screw.....
18144	6219	Arm Rotary Shaft Oil Pad (felt).....
144b	6198	" " " " " Screw.....
4288	6179	" Side Cover (back).....
286b	6198	" " " " " Thumb Screw....
4288	6179	" " " (front).....
286b	6198	" " " " " Thumb Screw....
23873	6210	Balance Wheel, 2 $\frac{1}{8}$ in. pulley, with two 430c.....
430c	6208	Balance Wheel Set Screw.....
49106	6175	Cloth Plate.....
49016	—	" " Slide.....
38419	6181	" " " Spring.....
725J	6181	" " " " " Screw.....
49017	6179	Cloth Plate Slide complete, Nos. 38419, 49016 and two 725J.....
49107	—	Cloth Plate complete, Nos. 49017, 49053, 49054, 49106, 49116 and two 226b.....
50085F	6198	Cloth Plate Screw.....
49265	6220	Crank Connecting Rod with 49099 and two 145E.....
49266	—	Crank Connecting Rod 49265 with 1513J and 50147c.....
*49099	—	Crank Connecting Rod Cap.....
145E	6198	" " " " " Screw.....
50147c	6198	" " " " " Hinge Screw.....
1513J	6198	" " " " " " Nut
49020	6179	Face Plate.....
193F	6181	" " " " " " Screw.....
49021	6209	Feed Bar with 220b and 457c.....
49022	6209	" " " " " Hinge Pin.....
457c	6196	" " " " " Set Screw.....
49023	6209	" Connecting Rod with 2653, 4784, 49024 and two 896E.....
*49024	—	Feed Connecting Rod Cap.....
896E	6209	" " " " " " Screw.....
4784	6192	" " " " " Oil Pad (felt).....
2653	6206	" " " " " " Pin.....
49025	6182	" Dog, 15 teeth (10 teeth to the inch) for large bags.....
49153	6188	Feed Dog, 16 teeth (14 teeth to the inch) for small bags.....
49103	6182	Feed Dog, spiked teeth, 15 teeth (10 teeth to the inch) for clay filled bags.....
49125	6184	Feed Dog (double) 17 teeth (12 teeth to the inch).....

NO.	PLATE	NAME
49089	6192	Looper Carrier Pitman Head (right) Nos. 49085, 49087, 50070c and two 171E....
49046	6192	Looper Carrier Pitman Rod.....
1708E	6192	“ “ “ “ Nut (left)...
1709E	6192	“ “ “ “ “ (right)...
49043	6192	“ “ “ Washer (fibre)....
49047	6193	“ “ “ Rock Shaft.....
11411	6193	“ “ “ “ Collar with 453c.....
453c	6193	Looper Carrier Rock Shaft Collar Set Screw.....
49048	6193	Looper Carrier Rock Shaft Crank (back) forked, with 50083c.....
50083c	6193	Looper Carrier Rock Shaft Crank (back) Set Screw.....
49049	6193	Looper Carrier Rock Shaft Crank (back) Slide Block.....
49248	6193	Looper Carrier Rock Shaft Crank (front) with 157D and two 1324E.....
1324E	6193	Looper Carrier Rock Shaft Crank (front) Clamping Screw.....
49142	6193	Looper Eccentric with two 1036c.....
49258	—	“ “ 49142 with 49049.....
1036c	6193	“ “ Set Screw.....
49116	6210	“ Gate with 448c.....
49053	6181	“ “ Hinge Pin.....
448c	6181	“ “ “ “ Set Screw.....
49054	6181	“ “ Lock Spring.....
226D	6181	“ “ “ “ Screw.....
1147c	6192	“ Set Screw.....
49080	6192	“ Thread Guard.....
590D	6192	“ “ “ Screw.....
49055	6194	Needle Bar (hollow).....
49056	6194	“ “ Bushing (lower).....
435c	6194	“ “ “ “ Set Screw...
49056	6194	“ “ “ (upper).....
1133E	6195	“ “ “ “ Set Screw...
*49101	6194	“ “ Connecting Link.....
49167	—	“ “ “ “ 49101 with 49057 and 49268.....
49057	6194	Needle Bar Connecting Link Hinge Stud
1517J	6194	“ “ “ “ “ “ “ Nut.....
49268	6219	Needle Bar Connecting Stud with 704E..
704E	6219	“ “ “ “ “ Clamping Screw.....

NO.	PLATE	NAME
1629c	6194	Needle Clamping Nut.....
49059	6195	Presser Bar.....
49060	6195	“ “ Bushing (lower).....
435c	6195	“ “ “ “ Set Screw...
49061	6195	“ “ “ (upper).....
1133E	6195	“ “ “ “ Set Screw....
49062	6195	“ “ Lifter.....
212D	6195	“ “ “ Cap Screw.....
49063	6195	“ “ “ Friction Washer.....
49064	6195	“ “ “ Hinge Stud.....
453c	6195	“ “ “ “ “ Set Screw..
49065	6195	“ “ Lifting Bracket with 453c and 892F.....
892F	6195	Presser Bar Lifting Bracket Adjusting Screw.....
453c	6195	Presser Bar Lifting Bracket Set Screw...
49066	6195	“ “ “ Link.....
212D	6195	“ “ “ “ Cap Screw.....
724D	6195	“ “ “ “ Hinge Screw....
49067	6179	“ “ Spring (flat).....
38468	6195	“ “ “ Stud.....
49082	6188	“ Foot for 49153.....
50087F	6198	“ “ Hinge Screw.....
49068	—	“ “ Plate.....
49069	—	“ “ Shank.....
49070	6182	Presser Foot (hinged) complete for 49025 and 49103, Nos. 49068, 49069 and 50087F
50087F	6198	Presser Foot Hinge Screw.....
49126	—	“ “ Plate.....
49127	—	“ “ Shank.....
49128	6184	Presser Foot (hinged) complete for 49125, Nos. 49126, 49127 and 50087F.....
190D	6198	Presser Foot Screw.....
574w	6198	Pressure Regulating Thumb Screw.....
1539w	6198	“ “ “ “ Lock Nut.....
2102	6194	Tension (under thread) Disc.....
1560c	6194	“ “ “ “ Regulating Thumb Nut.....
916c	6194	Tension (under thread) Screw Stud.....
44209	—	“ “ “ “ “ “ 916c with 1560c.....
10148	6194	Tension (under thread) Spring.....
49220	6214	“ “ “ Thread Guide....
2102	6194	“ (upper thread) Disc.....
1560c	6194	“ “ “ “ Regulating Thumb Nut.....

NO.	PLATE	NAME
916c	6194	Tension (upper thread) Screw Stud.....
44209	—	“ “ “ “ “ 916c with 1560c.....
13710	6194	Tension (upper thread) Spring.....
49220	6214	“ “ “ Thread Guide....
49071	6194	Thread (under) Eyelet.....
172F	6194	“ “ “ Screw.....
49072	6196	“ “ Take-up.....
190D	6196	“ “ “ Screw.....
49073	6196	“ (upper) Controller.....
974F	6196	“ “ “ Hinge Screw..
914F	6196	“ “ “ Screw.....
39541	6196	“ “ “ Washer
49075	6196	“ “ Take-up with 457c.....
457c	6196	“ “ “ Set Screw.....
49129	6184	Throat Plate, for double thread, for 49125
49130	6184	“ “ with 665D and 49078, for single thread, for 49125.....
49131	6182	Throat Plate, for double thread, for 49025 and 49103.....
49132	6182	Throat Plate, with 665D and 49078, for single thread, for 49025 and 49103.....
49154	6188	Throat Plate, for double thread, for 49153
49155	6188	“ “ with 665D and 49078, for sin- gle thread, for 49153.....
691F	6198	Throat Plate Screw.....
49078	6181	“ “ Thread Retainer.....
665D	6181	“ “ “ “ Screw.....

Genuine Singer Needles and their Containers are marked with the Company's Trade Mark "SIMANCO." 1

Needles in Containers marked "For Singer Machines" are not Singer made needles. 2

LIST OF PARTS COMPLETE FOR MACHINE No. 92-2

FOR BAG WORK. STITCH FROM 1/4 TO 1/2 INCH LONG. HAS ONE NEEDLE, ONE LOOPER AND THROAT PLATE FOR SINGLE THREAD; ALSO LOOPER AND THROAT PLATE FOR TWO-THREAD CHAIN STITCH.

NO.	PLATE	NAME
*49001	—	Arm, upper and lower (solid).....
18130	6205	“ Oil Tube with 52045, for front bearing.....
18130	6205	Arm Oil Tube with 52045, for intermediate bearing.....
11119	6205	Arm Oil Tube with 52045, for oiling 49101
18130	6205	“ “ “ “ 52045, for oiling 49049
49091	6205	“ “ “ “ 49092, for oiling 49265 (lower bearing).....
49141	6213	Arm Oil Tube with 56006, for oiling 49265 (upper bearing).....
52045	6197	Arm Oil Tube Packing (braided cotton) for 11119 and 18130.....
56006	6197	Arm Oil Tube Packing (braided cotton) for 49141.....
49092	6205	Arm Oil Tube Packing (felt) for 49091..
49156	6207	“ Rock Shaft.....
49271	—	“ “ “ 49156 with 49261.....
49003	6208	“ “ “ Bushing (back).....
446c	6208	“ “ “ “ “ Set Screw
49004	6208	“ “ “ “ (intermediate)
446c	6208	“ “ “ “ “ “ Set Screw.....
49006	6208	Arm Rock Shaft Collar with two 443c...
443c	6208	“ “ “ “ Set Screw.....
49261	6219	“ “ “ Crank (back) with 50282E and 50457c.....
50457c	6219	Arm Rock Shaft Crank (back) Position Screw.....
50282E	6208	Arm Rock Shaft Crank (back) Set Screw
49262	6219	“ “ “ “ (front) with 50282E and 50457c.....
50457c	6219	Arm Rock Shaft Crank (front) Position Screw.....
50282E	6208	Arm Rock Shaft Crank (front) Set Screw

NO.	PLATE	NAME
49005	6208	Arm Rock Shaft Flanged Bushing (front)
430c	6208	" " " " " "
		Set Screw.....
49084	6181	Arm Rock Shaft Oil Cover.....
193D	6181	" " " " " Screw.....
49105	6211	" Rotary Shaft.....
49264	—	" " " 49105 with 49266.....
49011	6181	" " " Bushing (front).....
430c	6208	" " " " " SetScrew
49010	6209	" " " Collar with two 1259c.
1259c	6209	" " " " Set Screw.....
49012	6179	" " " Flanged Bushing (back)
		with 49013 and 49093.....
49093	6205	Arm Rotary Shaft Flanged Bushing (back)
		Oil Pad (long) braided cotton.....
49013	6205	Arm Rotary Shaft Flanged Bushing (back)
		Oil Pad (short) braided cotton.....
159F	6198	Arm Rotary Shaft Flanged Bushing (back)
		Screw.....
49014	6181	Arm Rotary Shaft Flanged Bushing (inter-
		mediate).....
448c	6181	Arm Rotary Shaft Flanged Bushing (inter-
		mediate) Set Screw.....
18144	6219	Arm Rotary Shaft Oil Pad (felt).....
144D	6198	" " " Screw.....
4288	6179	" Side Cover (back).....
286D	6198	" " " " Thumb Screw....
4288	6179	" " " (front).....
286D	6198	" " " " Thumb Screw....
23873	6210	Balance Wheel, 2½ in. pulley, with two
		430c.....
430c	6208	Balance Wheel Set Screw.....
49143	6210	Cloth Plate.....
49016	—	" " Slide.....
38419	6181	" " Spring.....
725J	6181	" " " Screw.....
49017	6179	Cloth Plate Slide complete, Nos. 38419,
		49016 and two 725J.....
49144	—	Cloth Plate complete, Nos. 49017, 49053,
		49054, 49143, 49212 and two 226b....
50175F	6213	Cloth Plate Screw.....
49265	6220	Crank Connecting Rod with 49099 and
		two 145E.....
49266	—	Crank Connecting Rod 49265 with 1513J
		and 50147c.....
*49099	—	Crank Connecting Rod Cap.....
145B	6198	" " " " Screw.....

NO.	PLATE	NAME
50147c	6198	Crank Connecting Rod Hinge Screw.....
1513J	6198	" " " " " Nut
49020	6179	Face Plate.....
193F	6181	" " Screw.....
49110	6197	Feed Bar with 220b and 457c.....
49022	6209	" " Hinge Pin.....
457c	6196	" " " " Set Screw.....
49023	6209	" Connecting Rod with 2653, 4784,
		49024 and two 896E.....
*49024	—	Feed Connecting Rod Cap.....
896E	6209	" " " " Screw.....
4784	6192	" " " Oil Pad (felt)....
2653	6206	" " " " " Pin.....
49111	6185	" Dog, 14 teeth (7 teeth to the inch)
		for heavy bags.....
49138	6190	Feed Dog, 17 teeth (14 teeth to the inch)
		for medium and light bags.....
49146	6223	Feed Dog, 15 teeth (10 teeth to the inch)
172c	6194	" " Screw.....
220b	6209	" " Stop Screw.....
49112	6197	" Eccentric with two 1259c.....
1259c	6209	" " Set Screw.....
49113	6197	" Lifting Eccentric with two 1259c...
49253	6219	" " " Connection with
		457c, 2653, 49020, 55515 and two 896E
*49029	—	Feed Lifting Eccentric Connection Cap
896E	6209	" " " " " "
		Screw.....
49030	6209	Feed Lifting Eccentric Connection Hinge
		Pin.....
457c	6196	Feed Lifting Eccentric Connection Hinge
		Pin Set Screw.....
55515	6219	Feed Lifting Eccentric Connection Oil Pad
		(braided cotton).....
2653	6206	Feed Lifting Eccentric Connection Oil Pad
		Pin.....
1259c	6209	Feed Lifting Eccentric Set Screw.....
50086c	6181	" Regulating Screw Stud.....
1714c	6181	" " " " Nut.....
49031	6181	" " " " Sleeve.....
49032	6181	" " " " Washer....
49033	6179	" Rock Shaft.....
49114	—	Feed Rock Shaft complete, Nos. 49033 and
		49115.....
49115	6179	Feed Rock Shaft Crank with two 896E...
896E	6209	" " " " Clamping Screw
11398	6179	" " " Hinge Pin.....

NO.	PLATE	NAME
1508J	6198	Feed Rock Shaft Hinge Pin Nut.....
622C	6198	" " " " " Screw Bearing
1508J	6198	" " " " " " " "
		Nut.....
27398	6181	Feed Rock Shaft Washer.....
36421	6200	Guide.....
194D	6200	" Screw Stud.....
671D	6200	" Thumb Screw.....
49036	6192	Looper (double thread) with 590D and 49080.....
49037	6192	Looper (single thread).....
*49257	—	" Bell Crank.....
49038	6207	" " " 49257 with 4784.....
49039	6207	" " " Hinge Stud.....
448C	6181	" " " " " Set Screw
4784	6192	" " " Oil Pad (felt).....
49158	6207	" " " Pitman with 46223, 49041 and two each 171E and 1057E...
49250	—	Looper Bell Crank Pitman 49158 with 50069C and 50070C.....
50070C	6192	Looper Bell Crank Pitman Ball Screw Stud (lower).....
1636C	6198	Looper Bell Crank Pitman Ball Screw Stud (lower) Nut.....
50069C	6208	Looper Bell Crank Pitman Ball Screw Stud (upper).....
1619E	6208	Looper Bell Crank Pitman Ball Screw Stud (upper) Nut.....
*49041	—	Looper Bell Crank Pitman Cap (lower)
171E	6192	" " " " " " "
		Screw.....
*46223	—	Looper Bell Crank Pitman Cap (upper)
1057E	6209	" " " " " " "
		Screw.....
49043	6192	Looper Bell Crank Pitman Washer (fibre)
49044	6192	" Carrier with 4784 and two each 175E, 1147C and 59019.....
49194	—	Looper Carrier 49044 with 49165, 49166 and 49248.....
175E	6192	Looper Carrier Clamping Screw.....
59019	6197	" " Gib.....
49165	6192	" " Hinge Pin.....
49166	6192	" " " " Collar with two 202F.....
202F	6192	Looper Carrier Hinge Pin Collar Set Screw
157D	6193	" " " " Clamping Screw
4784	6192	" " Oil Pad (felt).....

NO.	PLATE	NAME
49045	6192	Looper Carrier Pitman complete, Nos. 1708E, 1709E, 49046, 49088 and 49089
50070C	6192	Looper Carrier Pitman Ball Screw Stud
1519J	6192	" " " " " " "
		Nut.....
46237	6192	Looper Carrier Pitman Ball Stud (left)
1147C	6192	" " " " " " "
		Set Screw.....
*49085	—	Looper Carrier Pitman Cap (left).....
171E	6192	" " " " " Screw
*49085	—	" " " " (right).....
171E	6192	" " " " " Screw
*49086	—	" " " End Bearing (left)
*49087	—	" " " " (right)
49088	6192	Looper Carrier Pitman Head (left), Nos. 46237, 49085, 49086 and two 171E....
49089	6192	Looper Carrier Pitman Head (right), Nos. 49085, 49087, 50070C and two 171E....
49046	6192	Looper Carrier Pitman Rod.....
1708E	6192	" " " " Nut (left)...
1709E	6192	" " " " " (right)...
49043	6192	" " " Washer (fibre)....
49047	6193	" " Rock Shaft.....
11411	6193	" " " " Collar with 453C
453C	6193	" " " " " Set Screw
49048	6193	" " " " Crank (back) forked, with 50083C.....
50083C	6193	Looper Carrier Rock Shaft Crank (back) Set Screw.....
49049	6193	Looper Carrier Rock Shaft Crank (back) Slide Block.....
49248	6193	Looper Carrier Rock Shaft Crank (front) with 157D and two 1324E.....
1324E	6193	Looper Carrier Rock Shaft Crank (front) Clamping Screw.....
49142	6193	Looper Eccentric with two 1036C.....
49258	—	" " 49142 with 49049.....
1036C	6193	" " Set Screw.....
49212	6210	" Gate with 448C.....
49053	6181	" " Hinge Pin.....
448C	6181	" " " " Set Screw.....
49054	6181	" " Lock Spring.....
226D	6181	" " " " Screw.....
1147C	6192	" Set Screw.....
49080	6192	" Thread Guard.....
590D	6192	" " " Screw.....
49055	6194	Needle Bar (hollow).....

NO.	PLATE	NAME
49117	6197	Needle Bar Bushing (lower).....
435c	6194	" " " " Set Screw....
49056	6194	" " " (upper).....
1133E	6195	" " " " Set Screw....
*49101	6194	" " Connecting Link.....
49167	—	" " " " 49101 with 49057 and 49268.....
49057	6194	Needle Bar Connecting Link Hinge Stud
1517J	6194	" " " " " "
		Nut.....
49268	6219	Needle Bar Connecting Stud with 704E..
704E	6219	" " " " Clamping Screw.....
1629c	6194	Needle Clamping Nut.....
49059	6195	Presser Bar.....
49060	6195	" " Bushing (lower).....
435c	6195	" " " " Set Screw....
49061	6195	" " " (upper).....
1133E	6195	" " " " Set Screw....
49062	6195	" " Lifter.....
212D	6195	" " " Cap Screw.....
49063	6195	" " " Friction Washer.....
49064	6195	" " " Hinge Stud.....
453c	6195	" " " " " Set Screw....
49065	6195	" " " Lifting Bracket with 453c and 892F.....
892F	6195	Presser Bar Lifting Bracket Adjusting Screw.....
453c	6195	Presser Bar Lifting Bracket Set Screw....
49066	6195	" " " Link.....
212D	6195	" " " " Cap Screw.....
724D	6195	" " " " Hinge Screw....
49067	6179	" " Spring (flat).....
38468	6195	" " " Stud.....
50087F	6198	" Foot Hinge Screw.....
49118	—	" " Plate.....
49119	—	" " Shank.....
49120	6185	Presser Foot (hinged) complete for 49111, Nos. 49118, 49119 and 50087F.....
50087F	6198	Presser Foot Hinge Screw.....
49126	—	" " Plate.....
49127	—	" " Shank.....
49128	6184	Presser Foot (hinged) complete for 49138, Nos. 49126, 49127 and 50087F.....
50087F	6198	Presser Foot Hinge Screw.....
49068	—	" " Plate.....
49069	—	" " Shank.....

NO.	PLATE	NAME
49070	6182	Presser Foot (hinged) complete for 49116, Nos. 49068, 49069 and 50087F.....
190D	6198	Presser Foot Screw.....
574w	6198	Pressure Regulating Thumb Screw.....
1539w	6198	" " " " Lock Nut.....
2102	6194	Tension (under thread) Disc.....
1560c	6194	" " " Regulating Thumb Nut.....
916c	6194	Tension (under thread) Screw Stud.....
44209	—	" " " " " 916c with 1560c.....
10148	6194	Tension (under thread) Spring.....
49220	6214	" " " Thread Guide....
2102	6194	" (upper thread) Disc.....
1560c	6194	" " " Regulating Thumb Nut.....
916c	6194	Tension (upper thread) Screw Stud.....
44209	—	" " " " " 916c with 1560c.....
13710	6194	Tension (upper thread) Spring.....
49220	6214	" " " Thread Guide....
49071	6194	Thread (under) Eyelet.....
172F	6194	" " " Screw.....
49072	6196	" " Take-up.....
190D	6196	" " " Screw.....
49073	6196	" (upper) Controller.....
974F	6196	" " " Hinge Screw..
914F	6196	" " " Screw.....
39541	6196	" " " " Washer
49075	6196	" " Take-up with 457c.....
457c	6196	" " " Set Screw.....
49149	6221	Throat Plate, for double thread, for 49111
49150	6221	" " with 665D and 49078, for single thread, for 49111.....
49151	6222	Throat Plate, for double thread, for 49138
49152	6222	" " with 665D and 49078, for single thread, for 49138.....
49147	6223	Throat Plate, for double thread, for 49146
49148	6223	" " with 665D and 49078, for single thread, for 49146.....
742F	6198	Throat Plate Screw.....
49078	6181	" " Thread Retainer.....
665D	6181	" " " " Screw....

LIST OF PARTS COMPLETE FOR

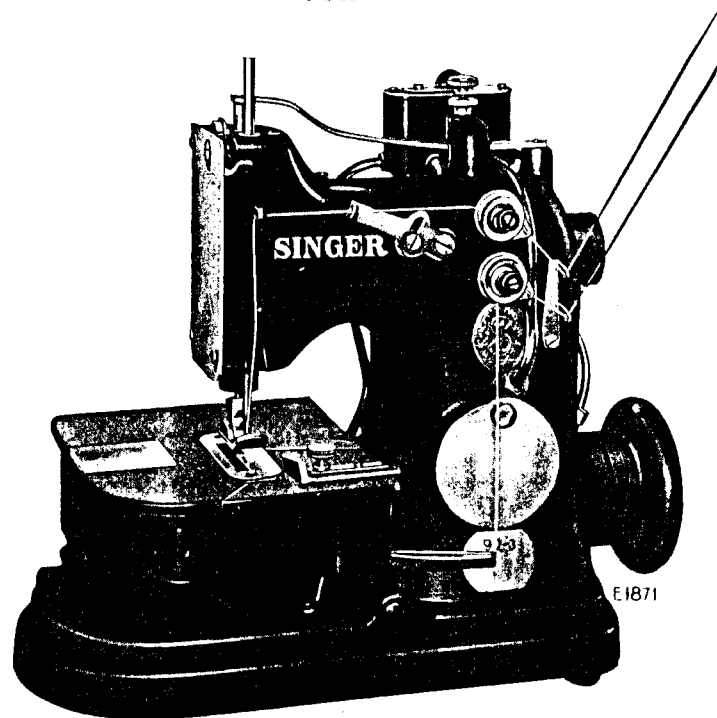

MACHINE No. 92-3

FOR SEWING CLAY-FILLED AND OTHER BAGS. STITCH FROM $\frac{1}{6}$ TO $\frac{1}{3}$ INCH LONG. HAS ONE NEEDLE, ONE LOOPER AND THROAT PLATE FOR SINGLE THREAD; ALSO LOOPER AND THROAT PLATE FOR TWO-THREAD CHAIN STITCH. FITTED WITH DEVICE FOR AUTOMATICALLY OILING THE PRINCIPAL BEARINGS OF THE MACHINE.

NO.	PLATE	NAME
*49168	—	Arm, upper and lower (solid).....
18130	6205	" Oil Tube with 52045, for front bearing.....
18130	6205	Arm Oil Tube with 52045, for intermediate bearing.....

NO.	PLATE	NAME
11119	6205	Arm Oil Tube with 52045, for oiling 49101
49169	6206	" " " " 49013, for oiling 49019
49091	6205	" " " " 49092, for oiling 49265 (lower bearing).....
49170	6206	Arm Oil Tube with 2653 and 49174, for oiling 46223.....
49171	6206	Arm Oil Tube with 2653 and 49174, for oiling 49265 (upper bearing).....
49172	6206	Arm Oil Tube with 2653 and 49174, for oiling 49023.....
54897	6206	Arm Oil Tube Oil Cup.....
49173	6206	" " " " Holder with 54897, for 49169.....
49013	6205	Arm Oil Tube Packing (braided cotton) for 49169.....
49174	6206	Arm Oil Tube Packing (braided cotton) for 49170 to 49172.....
52045	6197	Arm Oil Tube Packing (braided cotton) for 11119 and 18130.....
49092	6205	Arm Oil Tube Packing (felt) for 49091...
2653	6206	" " " " Stop Pin for 49170 to 49172.....
49156	6207	Arm Rock Shaft.....
49271	—	" " " 49156 with 49261.....
49003	6208	" " " Bushing (back).....
446c	6208	" " " " Set Screw
49004	6208	" " " " (intermediate)
446c	6208	" " " " "
		Set Screw.....
49006	6208	Arm Rock Shaft Collar with two 443c...
443c	6208	" " " " Set Screw.....
49261	6219	" " " Crank (back) with 50282E and 50457c.....
50457c	6219	Arm Rock Shaft Crank (back) Position Screw.....
50282E	6208	Arm Rock Shaft Crank (back) Set Screw
49262	6219	" " " " (front) with 50282E and 50457c.....
50457c	6219	Arm Rock Shaft Crank (front) Position Screw.....
50282E	6208	Arm Rock Shaft Crank (front) Set Screw
49005	6208	" " " Flanged Bushing (front)
430c	6208	" " " " " " "
		Set Screw.....
49084	6181	Arm Rock Shaft Oil Cover.....
193D	6181	" " " " " Screw.....
49097	6207	" Rotary Shaft.....

NO.	PLATE	NAME
49263	—	Arm Rotary Shaft 49097 with 49266.....
49011	6181	“ “ “ Bushing (front).....
430c	6208	“ “ “ “ “ SetScrew
49010	6209	“ “ “ Collar with two 1259c.
1259c	6209	“ “ “ “ Set Screw.....
49012	6179	“ “ “ Flanged Bushing (back) with 49013 and 49093.....
49093	6205	Arm Rotary Shaft Flanged Bushing (back) Oil Pad (long) braided cotton.....
49013	6205	Arm Rotary Shaft Flanged Bushing (back) Oil Pad (short) braided cotton.....
159F	6198	Arm Rotary Shaft Flanged Bushing (back) Screw.....
49014	6181	Arm Rotary Shaft Flanged Bushing (inter- mediate).....
448c	6181	Arm Rotary Shaft Flanged Bushing (inter- mediate) Set Screw.....
49013	6205	Arm Rotary Shaft Oil Pad (braided cotton) for front bearing.....
49013	6205	Arm Rotary Shaft Oil Pad (braided cotton) for intermediate bearing.....
50249E	6206	Arm Rotary Shaft Oil Pad Cap Screw....
144D	6198	“ “ “ Screw.....
4288	6179	“ Side Cover (back).....
286D	6198	“ “ “ “ Thumb Screw....
17677	6207	“ “ “ (front).....
286D	6198	“ “ “ “ Thumb Screw....
23873	6210	Balance Wheel, 2 $\frac{1}{8}$ in. pulley, with two 430c.....
430c	6181	Balance Wheel Set Screw.....
49175	6210	Cloth Plate with two 46224.....
46224	6206	“ “ Oil Cup.....
49016	—	“ “ Slide.....
38419	6181	“ “ “ Spring.....
725J	6181	“ “ “ “ Screw.....
49017	6179	Cloth Plate Slide complete, Nos. 38419, 49016 and two 725J.....
49176	—	Cloth Plate complete, Nos. 49017, 49053, 49054, 49116, 49175 and two 226D.....
50085F	6198	Cloth Plate Screw.....
49265	6220	Crank Connecting Rod with 49099 and two 145E.....
49266	—	Crank Connecting Rod 49265 with 1513J and 50147C.....

NO.	PLATE	NAME
*49099	—	Crank Connecting Rod Cap.....
145E	6198	“ “ “ “ Screw.....
50147C	6198	“ “ “ “ Hinge Screw.....
1513J	6198	“ “ “ “ “ Nut
49020	6179	Face Plate.....
193F	6181	“ “ Screw.....
49021	6209	Feed Bar with 220b and 457c.....
49022	6209	“ “ Hinge Pin.....
457c	6196	“ “ “ “ Set Screw.....
49023	6209	“ Connecting Rod with 2653, 4784, 49024 and two 896E.....
*49024	—	Feed Connecting Rod Cap.....
896E	6209	“ “ “ “ Screw.....
4784	6192	“ “ “ Oil Pad (felt).....
2653	6206	“ “ “ “ “ Pin.....
49025	6182	“ Dog, 15 teeth (10 teeth to the inch) for large bags.....
NOTE: No. 49025 is sent with this machine unless another Feed Dog is specified on order.		
49153	6188	Feed Dog, 16 teeth (14 teeth to the inch) for small bags.....
49125	6184	Feed Dog (double) 17 teeth (12 teeth to the inch).....
49103	6182	Feed Dog (spiked teeth) 15 teeth (10 teeth to the inch) for clay-filled bags.....
172c	6194	Feed Dog Screw.....
220D	6209	“ “ Stop Screw.....
49026	6209	“ Eccentric with two 1259c.....
1259c	6209	“ “ Set Screw.....
49113	6197	“ Lifting Eccentric with two 1259c....
49253	6219	“ “ “ “ Connection with 457c, 2653, 49029, 55515 and two 896E
*49029	—	Feed Lifting Eccentric Connection Cap
896E	6209	“ “ “ “ “ Screw.....
49030	6209	Feed Lifting Eccentric Connection Hinge Pin.....
457c	6196	Feed Lifting Eccentric Connection Hinge Pin Set Screw.....
55515	6219	Feed Lifting Eccentric Connection Oil Pad (braided cotton).....
2653	6206	Feed Lifting Eccentric Connection Oil Pad Pin.....
1259c	6209	Feed Lifting Eccentric Set Screw.....
50086c	6181	“ Regulating Screw Stud.....
1714c	6181	“ “ “ “ Nut.....

NO.	PLATE	NAME
1324E	6193	Looper Carrier Rock Shaft Crank (front) Clamping Screw.....
49142	6193	Looper Eccentric with two 1036c.....
49258	—	“ “ 49142 with 49049.....
1036c	6193	“ “ Set Screw.....
49116	6210	“ Gate with 448c.....
49053	6181	“ “ Hinge Pin.....
448c	6181	“ “ “ Set Screw.....
49054	6181	“ “ Lock Spring.....
226b	6181	“ “ “ “ Screw.....
1147c	6192	“ Set Screw.....
49080	6192	“ Thread Guard.....
590b	6192	“ “ “ Screw.....
49055	6194	Needle Bar (hollow).....
49056	6194	“ “ Bushing (lower).....
435c	6194	“ “ “ “ Set Screw....
49056	6194	“ “ “ (upper).....
1133E	6194	“ “ “ “ Set Screw....
*49101	6194	“ “ Connecting Link.....
49167	—	“ “ “ “ 49101 with 49057 and 49268.....
49057	6194	Needle Bar Connecting Link Hinge Stud
1517J	6194	“ “ “ “ “ “ “ Nut.....
49268	6219	Needle Bar Connecting Stud with 704E..
704E	6219	“ “ “ “ Clamping Screw.....
1629c	6194	Needle Clamping Nut.....
49180	6212	Oil Cup.....
49181	—	Oil Cup complete, Nos. 195E, 49180, 49182 to 49184 and two 175E.....
49182	6212	Oil Cup Cover.....
175E	6192	“ “ “ Screw.....
49183	6206	“ “ Oil Hole Cover.....
195E	6206	“ “ “ “ Screw.....
49184	6212	“ “ “ Strainer.....
690b	6206	“ “ “ Screw.....
49185	6212	“ Pipe with 49191, for oiling 49265.....
49186	6212	“ “ “ 49191, for oiling 49012.....
49187	6212	“ “ “ 49191, for oiling 49011 and 49014.....
49188	6206	Oil Pipe Connection with 49189 and two 198b, for 49187, for oiling 49014.....
*49189	—	Oil Pipe Connection Cap.....
198b	6206	“ “ “ “ Screw.....
49190	6206	“ “ Coupling.....
1733b	6206	“ “ “ Nut.....

NO.	PLATE	NAME
49191	6206	Oil Pipe Sleeve.....
49059	6195	Presser Bar.....
49060	6195	“ “ Bushing (lower).....
435c	6195	“ “ “ “ Set Screw....
49061	6195	“ “ “ (upper).....
1133E	6195	“ “ “ “ Set Screw....
49062	6195	“ “ Lifter.....
212b	6195	“ “ “ Cap Screw.....
49063	6195	“ “ “ Friction Washer.....
49064	6195	“ “ “ Hinge Stud.....
453c	6195	“ “ “ “ Set Screw....
49065	6195	“ “ Lifting Bracket with 453c and 892F.....
892F	6195	Presser Bar Lifting Bracket Adjusting Screw.....
453c	6195	Presser Bar Lifting Bracket Set Screw....
49066	6195	“ “ “ Link.....
212b	6195	“ “ “ “ Cap Screw....
724b	6195	“ “ “ “ Hinge Screw....
49067	6179	“ “ Spring (flat).....
38468	6195	“ “ “ Stud.....
49082	6188	“ Foot for 49153.....
50087F	6198	“ “ Hinge Screw.....
49126	—	“ “ Plate.....
49127	—	“ “ Shank.....
49128	6184	Presser Foot (hinged) complete for 49025 and 49125, Nos. 49126, 49127 and 50087F

NOTE: No. 49128 is sent with this machine unless another Presser Foot is specified on order.

50087F	6198	Presser Foot Hinge Screw.....
49068	—	“ “ Plate.....
49069	—	“ “ Shank.....
49070	6182	Presser Foot (hinged) complete for 49025 and 49103, Nos. 49068, 49069 and 50087F
190b	6198	Presser Foot Screw.....
574w	6198	Pressure Regulating Thumb Screw.....
1539w	6198	“ “ “ “ Lock Nut.....
2102	6194	Tension (under thread) Disc.....
1560c	6194	“ “ “ Regulating Thumb Nut.....
916c	6194	Tension (under thread) Screw Stud.....
44209	—	“ “ “ “ “ 916c with 1560c.....
10148	6194	Tension (under thread) Spring.....
49220	6214	“ “ “ Thread Guide....

NO.	PLATE	NAME
2102	6194	Tension (upper thread) Disc.....
1560c	6194	“ “ “ Regulating Thumb Nut.....
916c	6194	Tension (upper thread) Screw Stud.....
44209	—	“ “ “ “ “ 916c with 1560c.....
13710	6194	Tension (upper thread) Spring.....
49220	6214	“ “ “ Thread Guide....
49192	6206	Thread Guide (double) side of arm.....
190b	6196	“ “ “ “ “ Screw
49071	6194	“ (under) Eyelet.....
172F	6194	“ “ “ Screw.....
49072	6196	“ “ Take-up.....
190b	6196	“ “ “ Screw.....
49073	6196	“ (upper) Controller.....
974F	6196	“ “ “ Hinge Screw.
914F	6196	“ “ “ Screw.....
39541	6196	“ “ “ Washer
49075	6196	“ “ Take-up with 457c.....
457c	6196	“ “ “ Set Screw.....
49131	6182	Throat Plate, for double thread, for 49025 and 49103.....
49132	6182	Throat Plate with 665b and 49078, for single thread, for 49025 and 49103.....
NOTE: Nos. 49131 and 49132 are sent with this Machine unless another Throat Plate is specified on order		
49269	6224	Throat Plate, for double thread, for 49125
49270	6224	“ “ with 665b and 49078, for single thread, for 49125.....
49154	6188	Throat Plate, for double thread, for 49153
49155	6188	“ “ with 665b and 49078, for single thread, for 49153.....
691F	6198	Throat Plate Screw.....
49078	6181	“ “ Thread Retainer.....
665b	6181	“ “ “ “ Screw.....

LIST OF PARTS COMPLETE FOR

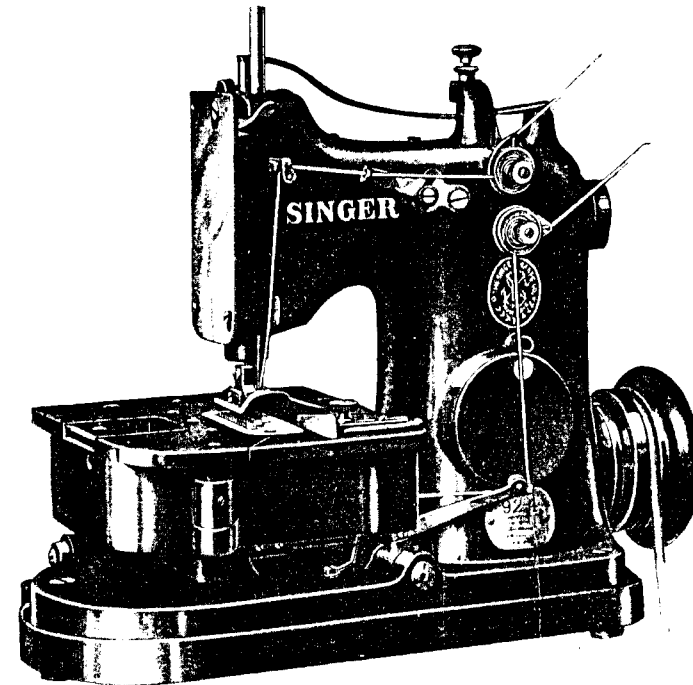

MACHINE No. 92-4

FOR STITCHING HEAVY BURLAP BAGS WITH FLAX, JUTE OR HEMP TWINE. MAKES TWO TO FOUR STITCHES TO THE INCH. HAS ONE NEEDLE, ONE LOOPER AND THROAT PLATE FOR SINGLE THREAD; ALSO LOOPER AND THROAT PLATE FOR TWO-THREAD CHAIN STITCH. HAS THE MECHANISM FOR REGULATING THE LENGTH OF STITCH ARRANGED SO THAT IT CAN BE ADJUSTED FROM THE TOP OF THE CLOTH PLATE, THERE BEING A CLEARANCE HOLE IN THE CLOTH PLATE FOR THIS PURPOSE. FITTED WITH NEEDLE BAR TO ACCOMMODATE .130 SHANK NEEDLE.

NO.	PLATE	NAME
*49001	—	Arm, upper and lower (solid).....
18130	6205	“ Oil Tube with 52045, for front bearing
18130	6205	“ “ “ “ 52045, for intermediate bearing.....

NO.	PLATE	NAME
11119	6205	Arm Oil Tube with 52045, for oiling 49101
18130	6205	" " " " 52045, for oiling 49049
49091	6205	" " " " 49092, for oiling 49265 (lower bearing).....
49141	6213	Arm Oil Tube with 56006, for oiling 49265 (upper bearing).....
52045	6197	Arm Oil Tube Packing (braided cotton) for 11119 and 18130.....
56005	6197	Arm Oil Tube Packing (braided cotton) for 49141.....
49092	6205	Arm Oil Tube Packing (felt) for 49091....
49156	6207	" Rock Shaft.....
49271	—	" " " 49156 with 49261.....
49003	6208	" " " Bushing (back).....
446c	6208	" " " " Set Screw
49004	6208	" " " " (intermediate)
446c	6208	" " " " " "
		Set Screw.....
49006	6208	Arm Rock Shaft Collar with two 413c....
443c	6208	" " " " Set Screw.....
49261	6219	" " " Crank (back) with 50282E and 50457c.....
50457c	6219	Arm Rock Shaft Crank (back) Position Screw.....
50282E	6208	Arm Rock Shaft Crank (back) Set Screw
49262	6219	" " " " (front) with 50282E and 50457c.....
50457c	6219	Arm Rock Shaft Crank (front) Position Screw.....
50282E	6208	Arm Rock Shaft Crank (front) Set Screw
49005	6208	" " " Flanged Bushing (front)
430c	6208	" " " " " " "
		Set Screw.....
49084	6181	Arm Rock Shaft Oil Cover.....
193b	6181	" " " " " Screw.....
49105	6211	" Rotary Shaft.....
49264	—	" " " 49105 with 49266.....
49011	6181	" " " Bushing (front).....
430c	6208	" " " " " S e t Screw.....
49010	6209	Arm Rotary Shaft Collar with two 1259c
1259c	6209	" " " " Set Screw.....
49012	6179	" " " Flanged Bushing (back) with 49013 and 49093.....
49093	6205	Arm Rotary Shaft Flanged Bushing (back) Oil Pad (long) braided cotton.....

NO.	PLATE	NAME
49013	6205	Arm Rotary Shaft Flanged Bushing (back) Oil Pad (short) braided cotton.....
159F	6198	Arm Rotary Shaft Flanged Bushing (back) Screw.....
49014	6181	Arm Rotary Shaft Flanged Bushing (inter- mediate).....
448c	6181	Arm Rotary Shaft Flanged Bushing (inter- mediate) Set Screw.....
49013	6205	Arm Rotary Shaft Oil Pad (braided cotton) for front bearing.....
144b	6198	Arm Rotary Shaft Screw.....
4288	6179	" Side Cover (back).....
286b	6198	" " " " Thumb Screw....
4288	6179	" " " (front).....
286b	6198	" " " " Thumb Screw....
46220	6210	Balance Wheel, 2 $\frac{1}{8}$ in. pulley, with two 430c.....
430c	6181	Balance Wheel Set Screw.....
49195	6210	Cloth Plate.....
49016	—	" " Slide.....
38419	6181	" " " Spring.....
725f	6181	" " " " Screw.....
49017	6179	Cloth Plate Slide complete, Nos. 38419, 49016 and two 725f.....
49196	—	Cloth Plate complete, Nos. 49017, 49053, 49054, 49195, 49212 and two 226b....
50175E	6213	Cloth Plate Screw.....
49265	6220	Crank Connecting Rod with 49099 and two 145E.....
49266	—	Crank Connecting Rod 49265 with 1513j and 50147c.....
*49099	—	Crank Connecting Rod Cap.....
145E	6198	" " " " Screw.....
50147c	6198	" " " " Hinge Screw....
1513j	6198	" " " " " Nut
49020	6179	Face Plate.....
193F	6181	" " Screw.....
49197	6213	Feed Bar with 220b and 457c.....
49022	6209	" " Hinge Pin.....
457c	6196	" " " " Set Screw.....
49198	6213	" Connecting Rod with 4781, 49199, 49241 and two 896E.....
*49199	—	Feed Connecting Rod Cap.....
896E	6209	" " " " Screw.....
49200	6213	" " " Hinge Pin.....
457c	6196	" " " " Set Screw
4781	6192	" " " Oil Pad (felt).....

NO.	PLATE	NAME
*49086	—	Looper Carrier Pitman End Bearing (left)
*49087	—	“ “ “ “ “ (right)
49088	6192	“ “ “ Head (left), Nos. 46237, 49085, 49086 and two 171E....
49089	6192	Looper Carrier Pitman Head (right), Nos. 49085, 49087, 50070c and two 171E....
49046	6192	Looper Carrier Pitman Rod.....
1708E	6192	“ “ “ “ Nut (left)....
1709E	6192	“ “ “ “ “ (right)....
49043	6192	“ “ “ Washer (fibre)....
49047	6193	“ “ “ Rock Shaft.....
11411	6193	“ “ “ “ Collar with 453c.....
453c	6193	Looper Carrier Rock Shaft Collar Set Screw.....
49048	6193	Looper Carrier Rock Shaft Crank (back) forked, with 50083c.....
50083c	6193	Looper Carrier Rock Shaft Crank (back) Set Screw.....
49049	6193	Looper Carrier Rock Shaft Crank (back) Slide Block.....
49248	6193	Looper Carrier Rock Shaft Crank (front) with 157D and two 1324E.....
1324E	6193	Looper Carrier Rock Shaft Crank (front) Clamping Screw.....
49142	6193	Looper Eccentric with two 1036c.....
49258	—	“ “ 49142 with 49049.....
1036c	6193	“ “ Set Screw.....
49212	6210	“ Gate with 448c.....
49053	6181	“ “ Hinge Pin.....
448c	6181	“ “ “ “ Set Screw.....
49054	6181	“ “ Lock Spring.....
226D	6181	“ “ “ “ Screw.....
1147c	6192	“ Set Screw.....
49213	6214	“ Thread Guard.....
590D	6192	“ “ “ Screw.....
49214	6214	Needle Bar (hollow).....
49215	6214	“ “ Bushing (lower).....
435c	6194	“ “ “ “ Set Screw....
49216	6214	“ “ “ (upper).....
1133E	6194	“ “ “ “ Set Screw....
*49101	6194	“ “ Connecting Link.....
49252	—	“ “ “ “ 49101 with 49057 and 49217.....
49057	6194	Needle Bar Connecting Link Hinge Stud
1517J	6194	“ “ “ “ “ “ “
		Nut.....

NO.	PLATE	NAME
49217	6214	Needle Bar Connecting Stud with 1454E.
1454E	—	“ “ “ “ Clamping Screw.....
1740c	6214	Needle Clamping Nut.....
49059	6195	Presser Bar.....
49060	6195	“ “ Bushing (lower).....
435c	6195	“ “ “ “ Set Screw....
49061	6195	“ “ “ (upper).....
1133E	6195	“ “ “ “ Set Screw....
49062	6195	“ “ Lifter.....
212D	6195	“ “ “ Cap Screw.....
49063	6195	“ “ “ Friction Washer.....
49064	6195	“ “ “ Hinge Stud.....
453c	6195	“ “ “ “ “ Set Screw
49065	6195	“ “ Lifting Bracket with 453c and 892E.....
892E	6195	Presser Bar Lifting Bracket Adjusting Screw.....
453c	6195	Presser Bar Lifting Bracket Set Screw....
49066	6195	“ “ “ Link.....
212D	6195	“ “ “ “ Cap Screw.....
721D	6195	“ “ “ “ Hinge Screw....
49067	6179	“ “ Spring (flat).....
38468	6195	“ “ “ Stud.....
50087E	6198	“ Foot Hinge Screw.....
49218	—	“ “ Plate.....
49119	—	“ “ Shank.....
49219	6189	Presser Foot (hinged) complete for 49201, Nos. 49119, 49218 and 50087E.....
190D	6198	Presser Foot Screw.....
574w	6198	Pressure Regulating Thumb Screw.....
1539w	6198	“ “ “ “ Lock Nut.....
2102	6194	Tension (under thread) Disc.....
1560c	6194	“ “ “ Regulating Thumb Nut.....
916c	6194	Tension (under thread) Screw Stud.....
44209	—	“ “ “ “ “ “ 916c with 1560c.....
10148	6194	Tension (under thread) Spring.....
49220	6214	“ “ “ Thread Guide....
2102	6194	“ (upper thread) Disc.....
1560c	6194	“ “ “ Regulating Thumb Nut.....
916c	6194	Tension (upper thread) Screw Stud.....
44209	—	“ “ “ “ “ “ 916c with 1560c.....

NO.	PLATE	NAME
13710	6194	Tension (upper thread) Spring.....
49220	6214	" " " Thread Guide....
49221	6214	Thread (under) Eyelet.....
172F	6194	" " " Screw.....
49222	6214	" " Take-up with 49223 and 49224.....
49223	6214	Thread (under) Take-up Roller.....
49224	6214	" " " " Pin.....
190D	6196	" " " Screw.....
49073	6196	" (upper) Controller.....
974F	6196	" " " Hinge Screw..
914F	6196	" " " Screw.....
39541	6196	" " " Washer
49225	6214	" " Take-up Arm with 457c.
457C	6196	" " " " Set Screw.
49223	6214	" " " Roller.....
49226	6214	" " " Bracket with 49223 and 49224.....
207D	6214	Thread (upper) Take-up Roller Bracket Screw.....
49224	6214	Thread (upper) Take-up Roller Pin.....
49227	---	Thread (upper) Take-up complete, Nos. 207D, 49225 and 49226.....
49228	6189	Throat Plate, for double thread, for 49201
49229	6189	" " with 665D and 49078, for single thread, for 49201.....
742F	6198	Throat Plate Screw.....
49078	6181	" " Thread Retainer.....
665D	6181	" " " " Screw.....

Genuine Singer Needles and their Containers are marked with the Company's Trade Mark "SIMANCO." 1

Needles in Containers marked "For Singer Machines" are not Singer made needles. 2

LIST OF PARTS COMPLETE

FOR

MACHINE No. 92-5

FOR STITCHING HEAVY BURLAP BAGS WITH FLAX, JUTE OR HEMP TWINE. MAKES TWO TO FOUR STITCHES TO THE INCH. HAS ONE NEEDLE, ONE LOOPER AND THROAT PLATE FOR SINGLE THREAD; ALSO LOOPER AND THROAT PLATE FOR TWO-THREAD CHAIN STITCH. HAS THE MECHANISM FOR REGULATING THE LENGTH OF STITCH ARRANGED SO THAT IT CAN BE ADJUSTED FROM THE TOP OF THE CLOTH PLATE, THERE BEING A CLEARANCE HOLE IN THE CLOTH PLATE FOR THIS PURPOSE.

NO.	PLATE	NAME
*49231	---	Arm, upper and lower (solid).....
18130	6205	" Oil Tube with 52045, for front bearing
18130	6205	" " " " 52045, for intermediate bearing.....
11119	6205	Arm Oil Tube with 52045, for oiling 49101
18130	6205	" " " " 52045, for oiling 49049
49091	6205	" " " " 49092, for oiling 49265 (lower bearing).....
49141	6213	Arm Oil Tube with 56006, for oiling 49265 (upper bearing).....
52045	6197	Arm Oil Tube Packing (braided cotton) for 11119 and 18130.....
56006	6197	Arm Oil Tube Packing (braided cotton) for 49141.....
49092	6205	Arm Oil Tube Packing (braided cotton) for 49091.....
49156	6207	Arm Rock Shaft.....
49271	---	" " " 49156 with 49261.....
49003	6208	" " " Bushing (back).....
446c	6208	" " " " " Set Screw
49004	6208	" " " " intermediate...
446c	6208	" " " " " Set Screw.....
49232	6215	Arm Rock Shaft Collar and Thread (upper) Nipper Eccentric with two 446c
446c	6215	Arm Rock Shaft Collar and Thread (upper) Nipper Eccentric Set Screw.....
49261	6219	Arm Rock Shaft Crank (back) with 50282e and 50457c.....
50457c	6219	Arm Rock Shaft Crank (back) Position Screw.....

NO.	PLATE	NAME
914c	6196	Feed Regulator Connection Screw.....
50331E	6213	" Regulating Screw.....
49204	6213	" " " Friction Washer.....
931E	6213	" " " StopScrewBushing.....
49205	6213	" " " Washer (fibre)....
49206	6213	" " " " (steel)....
49033	6179	" Rock Shaft.....
49207	—	Feed Rock Shaft complete, Nos. 49033 and 49208.....
49208	6213	Feed Rock Shaft Crank with two 896E... 896E 6209 " " " " Clamping Screw
11398	6179	" " " Hinge Pin.....
1508J	6198	" " " " Nut.....
622c	6198	" " " " " Screw Bearing
1508J	6198	" " " " " " " " Nut.....
27398	6181	Feed Rock Shaft Washer.....
36421	6200	Guide.....
194D	6200	" Screw Stud.....
671D	6200	" Thumb Screw.....
49233	6215	Looper (double thread) with 590D and 49213.....
49037	6192	Looper (single thread).....
*49257	—	" Bell Crank.....
49038	6207	" " " 49257 with 4784.....
49039	6207	" " " Hinge Stud.....
448c	6181	" " " " " Set Screw
4784	6192	" " " Oil Pad (felt).....
49158	6207	" " " Pitman with 46223, 49041 and two each 171E and 1057E... 49250 — Looper Bell Crank Pitman 49158 with 50069c and 50070c.....
50070c	6192	Looper Bell Crank Pitman Ball Screw Stud (lower).....
1636c	6198	Looper Bell Crank Pitman Ball Screw Stud (lower) Nut.....
50069c	6208	Looper Bell Crank Pitman Ball Screw Stud (upper).....
1619E	6208	Looper Bell Crank Pitman Ball Screw Stud (upper) Nut.....
*49041	—	Looper Bell Crank Pitman Cap (lower) 171E 6192 " " " " " " " " Screw.....
*46223	—	Looper Bell Crank Pitman Cap (upper) 1057E 6209 " " " " " " " " Screw.....
49043	6192	Looper Bell Crank Pitman Washer (fibre)

NO.	PLATE	NAME
*49260	—	Looper Carrier with two each 175E and 1147c and 59019.....
49211	6214	Looper Carrier 49260 with 4784.....
49247	—	" " 49211 with 49165, 49166 and 49248.....
175E	6192	Looper Carrier Clamping Screw.....
59019	6197	" " Gib.....
49165	6192	" " Hinge Pin.....
49166	6192	" " " " Collar with two 202F.....
202F	6192	Looper Carrier Hinge Pin CollarSetScrew
157D	6193	" " " " Clamping Screw
4784	6192	" " Oil Pad (felt).....
49045	6192	Looper Carrier Pitman complete, Nos. 1708E, 1709E, 49046, 49088 and 49089.
50070c	6192	Looper Carrier Pitman Ball Screw Stud
1519J	6192	" " " " " " " " Nut.....
46237	6192	Looper Carrier Pitman Ball Stud (left)
1147c	6192	" " " " " " " " Set Screw.....
*49085	—	Looper Carrier Pitman Cap (left).....
171E	6192	" " " " " " " " Screw..
*49085	—	" " " " " " " " (right).....
171E	6192	" " " " " " " " Screw
*49086	—	" " " " " " " " End Bearing (left)
*49087	—	" " " " " " " " (right)
49088	6192	" " " " " " " " Head (left), Nos. 46237, 49085, 49086 and two 171E.....
49089	6192	Looper Carrier Pitman Head (right), Nos. 49085, 49087, 50070c and two 171E.....
49046	6192	Looper Carrier Pitman Rod.....
1708E	6192	" " " " " " " " Nut (left)...
1709E	6192	" " " " " " " " (right)
49043	6192	" " " " " " " " Washer (fibre)....
49047	6193	" " " " " " " " Rock Shaft.....
11411	6193	" " " " " " " " Collarwith453c
453c	6193	" " " " " " " " SetScrew
49048	6193	" " " " " " " " Crank (back) forked, with 50083c.....
50083c	6193	Looper Carrier Rock Shaft Crank (back) Set Screw.....
49049	6193	Looper Carrier Rock Shaft Crank (back) Slide Block.....
49248	6193	Looper Carrier Rock Shaft Crank (front) with 157D and two 1324E.....

NO.	PLATE	NAME
1324E	6193	Looper Carrier Rock Shaft Crank (front) Clamping Screw.....
49142	6193	Looper Eccentric with two 1036c.....
49258	-----	" " 49142 with 49049.....
1036c	6193	" " Set Screw.....
49212	6210	" Gate with 448c.....
49053	6181	" " Hinge Pin.....
448c	6181	" " " " Set Screw.....
49054	6181	" " Lock Spring.....
226d	6181	" " " " Screw.....
1147c	6192	" Set Screw.....
49213	6214	" Thread Guard.....
590d	6192	" " " " Screw.....
49055	6194	Needle Bar (hollow).....
49117	6197	" " Bushing (lower).....
435c	6194	" " " " Set Screw...
49056	6194	" " " (upper).....
1133E	6194	" " " " Set Screw...
*49101	6194	" " Connecting Link.....
49167	-----	" " " " 49101 with 49057 and 49268.....
49057	6194	Needle Bar Connecting Link Hinge Stud
1517j	6194	" " " " " " " Nut.....
49268	6219	Needle Bar Connecting Stud with 704E..
704E	6219	" " " " " Clamping Screw.....
1629c	6194	Needle Clamping Nut.....
49059	6195	Presser Bar.....
49060	6195	" " Bushing (lower).....
435c	6195	" " " " Set Screw...
49061	6195	" " " (upper).....
1133E	6195	" " " " Set Screw...
49062	6195	" " Lifter.....
212d	6195	" " " Cap Screw.....
49063	6195	" " " Friction Washer.....
49064	6195	" " " Hinge Stud.....
453c	6195	" " " " " Set Screw
49065	6195	" " Lifting Bracket with 453c and 892F.....
892F	6195	Presser Bar Lifting Bracket Adjusting Screw.....
453c	6195	Presser Bar Lifting Bracket Set Screw...
49066	6195	" " " Link.....
212d	6195	" " " " Cap Screw.....
724d	6195	" " " " Hinge Screw.....
49067	6179	" " Spring (flat).....

NO.	PLATE	NAME
38468	6195	Presser Bar Spring Stud.....
50087F	6198	" Foot Hinge Screw.....
49234	-----	" " Plate.....
49119	-----	" " Shank.....
49235	6190	Presser Foot (hinged) complete for 49138, Nos. 49119, 49234 and 50087F.....
190d	6198	Presser Foot Screw.....
571w	6198	Pressure Regulating Thumb Screw.....
1539w	6198	" " " " Lock Nut.....
2102	6194	Tension (under thread) Disc.....
1560c	6194	" " " " Regulating Thumb Nut.....
916c	6194	Tension (under thread) Screw Stud.....
44209	-----	" " " " " " 916c and 1560c.....
10148	6194	Tension (under thread) Spring.....
49220	6214	" " " " Thread Guide...
2102	6194	" (upper thread) Disc.....
1560c	6194	" " " " Regulating Thumb Nut.....
916c	6194	Tension (upper thread) Screw Stud.....
44209	-----	" " " " " " 916c and 1560c.....
13710	6194	Tension (upper thread) Spring.....
49220	6214	" " " " Thread Guide...
49221	6214	Thread (under) Eyelet.....
172f	6194	" " " " Screw.....
49222	6214	" " Take-up with 49223 and 49224.....
49223	6214	Thread (under) Take-up Roller.....
49224	6214	" " " " Pin.....
190b	6196	" " " " Screw.....
49073	6196	" (upper) Controller.....
974F	6196	" " " " Hinge Screw
914F	6196	" " " " Screw.....
39541	6196	" " " " Washer
49236	6215	" " Nipper Bracket.....
49244	-----	Thread (upper) Nipper complete, Nos. 1560c, 32572, 49236, 49238, 50133c, 54738 and two 2102.....
181d	6215	Thread (upper) Nipper Bracket Screw...
2102	6215	" " " " Disc.....
1560c	6215	" " " " Regulating Thumb Nut.....
32572	6215	Thread (upper) Nipper Releasing Disc...
49237	6215	" " " " " Stud...

NO.	PLATE	NAME
50133c	6215	Thread (upper) Nipper Screw Stud.....
54738	6215	“ “ “ Spring.....
49238	6215	“ “ “ Thread Guide.....
49245	6215	“ “ “ Take-up Arm with 457c..
457c	6196	“ “ “ “ Set Screw
49223	6214	“ “ “ Roller.....
49226	6214	“ “ “ “ Bracket
		with 49223 and 49224.....
207D	6214	Thread (upper) Take-up Roller Bracket
		Screw.....
49224	6214	Thread (upper) Take-up Roller Pin.....
49246	—	Thread (upper) Take-up complete, Nos.
		207D, 49226 and 49245.....
49239	6190	Throat Plate, for double thread, for 49138
49240	6190	“ “ “ with 665D and 49078, for
		single thread, for 49138.....
742F	6198	Throat Plate Screw.....
49078	6181	“ “ “ Thread Retainer.....
665D	6181	“ “ “ “ Screw.....

Genuine Singer Needles and their Containers are marked with the Company's Trade Mark "SIMANCO." 1

Needles in Containers marked "For Singer Machines" are not Singer made needles. 2

LIST OF PARTS COMPLETE FOR MACHINE No. 92-6

FOR STITCHING HEAVY BURLAP BAGS WITH FLAX, JUTE OR HEMP TWINE, MAKES TWO TO FOUR STITCHES TO THE INCH. HAS ONE NEEDLE, ONE LOOPER AND THROAT PLATE FOR SINGLE THREAD; ALSO LOOPER AND THROAT PLATE FOR TWO-THREAD CHAIN STITCH.

NO.	PLATE	NAME
*49231	----	Arm, upper and lower (solid).....
18130	6205	“ Oil Tube with 52045, for front bearing
18130	6205	“ “ “ “ 52045, for intermediate
		bearing.....
11119	6205	Arm Oil Tube with 52045, for oiling 49101
18130	6205	“ “ “ “ 52045, for oiling 49049
49091	6205	“ “ “ “ 49092, for oiling 49265
		(lower bearing).....
49141	6213	Arm Oil Tube with 56006, for oiling 49265
		(upper bearing).....
52045	6197	Arm Oil Tube Packing (braided cotton)
		for 11119 and 18130.....
56006	6197	Arm Oil Tube Packing (braided cotton)
		for 49141.....
49092	6205	Arm Oil Tube Packing (felt) for 49091...
49156	6207	Arm Rock Shaft.....
49271	----	“ “ “ 49156 with 49261.....
49003	6208	“ “ “ Bushing (back).....
446c	6208	“ “ “ “ Set Screw
49004	6208	“ “ “ “ (intermediate)
446c	6208	“ “ “ “ “
		Set Screw.....
49232	6215	Arm Rock Shaft Collar with Thread (upper)
		Nipper Eccentric with two 446c.....
446c	6215	Arm Rock Shaft Collar and Thread (upper)
		Nipper Eccentric Set Screw.....
49261	6219	Arm Rock Shaft Crank (back) with 50282E
		and 50457c.....
50457c	6219	Arm Rock Shaft Crank (back) Position
		Screw.....
50282E	6208	Arm Rock Shaft Crank (back) Set Screw.
49262	6219	“ “ “ “ (front) with 50282E
		and 50457c.....

NO.	PLATE	NAME
50457c	6219	Arm Rock Shaft Crank (front) Position Screw.....
50282E	6208	Arm Rock Shaft Crank (front) Set Screw
49005	6208	" " " Flanged Bushing (front)
430c	6208	" " " " " " " " Set Screw.....
49105	6211	Arm Rotary Shaft.....
49264	—	" " " 49105 with 49266.....
49011	6181	" " " Bushing (front).....
430c	6208	" " " " " " " " S e t Screw.....
49010	6209	Arm Rotary Shaft Collar with two 1259c
1259c	6209	" " " " " Set Screw.....
49012	6179	" " " Flanged Bushing (back) with 49013 and 49093.....
49093	6205	Arm Rotary Shaft Flanged Bushing (back) Oil Pad (long) braided cotton.....
49013	6205	Arm Rotary Shaft Flanged Bushing (back) Oil Pad (short) braided cotton.....
159F	6198	Arm Rotary Shaft Flanged Bushing (back) Screw.....
49014	6181	Arm Rotary Shaft Flanged Bushing (intermediate).....
448c	6181	Arm Rotary Shaft Flanged Bushing (intermediate) Set Screw.....
49013	6205	Arm Rotary Shaft Oil Pad (braided cotton) for front bearing.....
49013	6205	Arm Rotary Shaft Oil Pad (braided cotton) for intermediate bearing.....
144D	6198	Arm Rotary Shaft Screw.....
4288	6179	" Side Cover (back).....
286D	6198	" " " " Thumb Screw....
4288	6179	" " " (front).....
286D	6198	" " " " Thumb Screw....
23873	6210	Balance Wheel, 2 $\frac{1}{8}$ in. pulley, with two 430c.....
430c	6181	Balance Wheel Set Screw.....
49143	6210	Cloth Plate.....
49016	—	" " Slide.....
38419	6181	" " " Spring.....
725J	6181	" " " " Screw.....
49017	6179	Cloth Plate Slide complete, Nos. 38419, 49016 and two 725J.....
49144	—	Cloth Plate complete, Nos. 49017, 49053, 49054, 49143, 49212 and two 226D.....
50175F	6213	Cloth Plate Screw.....

NO.	PLATE	NAME
49265	6220	Crank Connecting Rod with 49099 and two 145E.....
49266	—	Crank Connecting Rod 49265 with 1513J and 50147c.....
*49099	—	Crank Connecting Rod Cap.....
145E	6198	" " " " " Screw.....
50147c	6198	" " " " Hinge Screw.....
1513J	6198	" " " " " Nut
49020	6179	Face Plate.....
193F	6181	" " " Screw.....
49110	6197	Feed Bar with 220D and 457c.....
49022	6209	" " Hinge Pin.....
457c	6196	" " " " " Set Screw.....
49023	6209	" Connecting Rod with 2653, 4784, 49024 and two 896E.....
*49024	—	Feed Connecting Rod Cap.....
896E	6209	" " " " " Screw.....
4784	6192	" " " " Oil Pad (felt).....
2653	6206	" " " " " Pin.....
49138	6190	" Dog, 17 teeth (14 teeth to the inch) for medium and light bags.....
172c	6194	Feed Dog Screw.....
220D	6209	" " Stop Screw.....
49112	6197	" Eccentric with two 1259c.....
1259c	6209	" " " Set Screw.....
49113	6197	" Lifting Eccentric with two 1259c.....
49253	6219	" " " " Connection with 457c, 2653, 49029, 55515 and two 896E.....
*49029	—	Feed Lifting Eccentric Connection Cap
896E	6209	" " " " " " " " Screw.....
49030	6209	Feed Lifting Eccentric Connection Hinge Pin.....
457c	6196	Feed Lifting Eccentric Connection Hinge Pin Set Screw.....
55515	6219	Feed Lifting Eccentric Connection Oil Pad (braided cotton).....
2653	6206	Feed Lifting Eccentric Connection Oil Pad Pin.....
1259c	6209	Feed Lifting Eccentric Set Screw.....
50086c	6181	" Regulating Screw Stud.....
1714c	6181	" " " " " Nut.....
49031	6181	" " " " " Sleeve.....
49032	6181	" " " " " Washer.....
49033	6179	" Rock Shaft.....
49114	—	Feed Rock Shaft complete, Nos. 49033 and 49115.....

NO.	PLATE	NAME
49115	6179	Feed Rock Shaft Crank with two 896E...
896E	6209	" " " " Clamping Screw
11398	6179	" " " Hinge Pin.....
1508J	6198	" " " " " Nut.....
622C	6198	" " " " " Screw Bearing
1508J	6198	" " " " " " " "
		Nut.....
27398	6181	Feed Rock Shaft Washer.....
36421	6200	Guide.....
194b	6200	" Screw Stud.....
671b	6200	" Thumb Screw.....
49233	6215	Looper (double thread) with 590b and 49213.....
49037	6192	Looper (single thread).....
*49257	—	" Bell Crank.....
49038	6207	" " " 49257 with 4784.....
49039	6207	" " " Hinge Stud.....
448c	6181	" " " " " Set Screw
4784	6192	" " " Oil Pad (felt).....
49158	6207	" " " Pitman with 46223, 49041 and two each 171E and 1057E...
49250	—	Looper Bell Crank Pitman 49158 with 50069c and 50070c.....
50070c	6192	Looper Bell Crank Pitman Ball Screw Stud (lower).....
1636c	6198	Looper Bell Crank Pitman Ball Screw Stud (lower) Nut.....
50069c	6208	Looper Bell Crank Pitman Ball Screw Stud (upper).....
1619E	6208	Looper Bell Crank Pitman Ball Screw Stud (upper) Nut.....
*49041	—	Looper Bell Crank Pitman Cap (lower)
171E	6192	" " " " " " "
		Screw.....
*46223	—	Looper Bell Crank Pitman Cap (upper)
1057E	6209	" " " " " " "
		Screw.....
49043	6192	Looper Bell Crank Pitman Washer (fibre)
49044	6192	" Carrier with 4784 and two each 175E, 1147c and 59019.....
49194	—	Looper Carrier 49044 with 49165, 49166 and 49248.....
175E	6192	Looper Carrier Clamping Screw.....
59019	6197	" " Gib.....
49165	6192	" " Hinge Pin.....
49166	6192	" " " " Collar with two 202F.....

NO.	PLATE	NAME
202F	6192	Looper Carrier Hinge Pin Collar Set Screw
157b	6193	" " " " Clamping Screw
4784	6192	" " Oil Pad (felt).....
49045	6192	Looper Carrier Pitman complete, Nos. 1708E, 1709E, 49046, 49088 and 49089
50070c	6192	Looper Carrier Pitman Ball Screw Stud
1519J	6192	" " " " " " "
		Nut.....
46237	6192	Looper Carrier Pitman Ball Screw Stud (left).....
1147c	6192	Looper Carrier Pitman Ball Screw Stud (left) Set Screw.....
*49085	—	Looper Carrier Pitman Cap (left).....
171E	6192	" " " " " Screw..
*49085	—	" " " " " (right).....
171E	6192	" " " " " Screw
*49086	—	" " " End Bearing (left)
*49087	—	" " " " " (right)
49088	6192	" " " Head (left), Nos. 46237, 49085, 49086 and two 171E....
49089	6192	Looper Carrier Pitman Head (right), Nos. 49085, 49087, 50070c and two 171E....
49046	6192	Looper Carrier Pitman Rod.....
1708E	6192	" " " " Nut (left)...
1709E	6192	" " " " " (right)
49043	6192	" " " Washer (fibre)....
49047	6193	" " Rock Shaft.....
11411	6193	" " " " Collar with 453c
453c	6193	" " " " " Set Screw
49048	6193	" " " " Crank (back) forked, with 50083c.....
50083c	6193	Looper Carrier Rock Shaft Crank (back) Set Screw.....
49049	6193	Looper Carrier Rock Shaft Crank (back) Slide Block.....
49248	6193	Looper Carrier Rock Shaft Crank (front) with 157b and two 1324E.....
1324E	6193	Looper Carrier Rock Shaft Crank (front) Clamping Screw.....
49142	6193	Looper Eccentric with two 1036c.....
49258	—	" " 49142 with 49049.....
1036c	6193	" " Set Screw.....
49212	6210	" Gate with 448c.....
49053	6181	" " Hinge Pin.....
418c	6181	" " " " Set Screw.....
49054	6181	" " Lock Spring.....

NO.	PLATE	NAME
226b	6181	Looper Gate Lock Spring Screw.....
1147c	6192	" Set Screw.....
49213	6214	" Thread Guard.....
590b	6192	" " " Screw.....
49055	6194	Needle Bar (hollow).....
49117	6197	" " Bushing (lower).....
435c	6194	" " " " Set Screw...
49056	6194	" " " (upper).....
1133E	6194	" " " " Set Screw...
*49101	6194	" " Connecting Link.....
49167	---	" " " " 49101 with 49057 and 49268.....
49057	6194	Needle Bar Connecting Link Hinge Stud
1517j	6194	" " " " " "
		Nut.....
49268	6219	Needle Bar Connecting Stud with 704E...
704E	6219	" " " " Clamping Screw.....
1629c	6194	Needle Clamping Nut.....
49059	6195	Presser Bar.....
49060	6195	" " Bushing (lower).....
435c	6195	" " " " Set Screw...
49061	6195	" " " (upper).....
1133E	6195	" " " " Set Screw...
49062	6195	" " Lifter.....
212b	6195	" " " Cap Screw.....
49063	6195	" " " Friction Washer.....
49064	6195	" " " Hinge Stud.....
453c	6195	" " " " " Set Screw
49065	6195	" " Lifting Bracket with 453c and 892F.....
892F	6195	Presser Bar Lifting Bracket Adjusting Screw.....
453c	6195	Presser Bar Lifting Bracket Set Screw...
49066	6195	" " " Link.....
212b	6195	" " " " Cap Screw.....
724b	6195	" " " " Hinge Screw.....
49067	6179	" " Spring (flat).....
38468	6195	" " " Stud.....
50087F	6198	" Foot Hinge Screw.....
49234	---	" " Plate.....
49119	---	" " Shank.....
49235	6190	Presser Foot (hinged) complete for 49138, Nos. 49119, 49234 and 50087E.....
190b	6198	Presser Foot Screw.....
574w	6198	Pressure Regulating Thumb Screw.....

NO.	PLATE	NAME
1539w	6198	Pressure Regulating Thumb Screw Lock Nut.....
2102	6194	Tension (under thread) Disc.....
1560c	6194	" " " " Regulating Thumb Nut.....
916c	6194	Tension (under thread) Screw Stud.....
44209	---	" " " " " " 916c and 1560c.....
10118	6194	Tension (under thread) Spring.....
49220	6214	" " " Thread Guide....
2102	6194	" (upper thread) Disc.....
1560c	6194	" " " " Regulating Thumb Nut.....
916c	6194	Tension (upper thread) Screw Stud.....
44209	---	" " " " " " 916c and 1560c.....
13710	6194	Tension (upper thread) Spring.....
49220	6214	" " " Thread Guide....
49221	6214	Thread (under) Eyelet.....
172F	6194	" " " Screw.....
49222	6214	Thread (under) Take-up with 49223 and 49224.....
49223	6214	Thread (under) Take-up Roller.....
49224	6214	" " " " Pin.....
190b	6196	" " " Screw.....
49073	6196	" (upper) Controller.....
974F	6196	" " " Hinge Screw
914F	6196	" " " Screw.....
39541	6196	" " " " Washer
49236	6215	" " Nipper Bracket.....
49244	---	Thread (upper) Nipper complete, Nos. 1560c, 32572, 49236, 49238, 50133c, 51738 and two 2102.....
181b	6215	Thread (upper) Nipper Bracket Screw...
2102	6215	" " " Disc.....
1560c	6215	" " " " Regulating Thumb Nut.....
32572	6215	Thread (upper) Nipper Releasing Disc...
49237	6215	" " " " Stud...
50133c	6215	" " " " Screw Stud.....
54738	6215	" " " Spring.....
49238	6215	" " " Thread Guide....
49245	6215	" " Take-up Arm with 457C...
457c	6196	" " " " Set Screw...
49223	6214	" " " Roller.....
49226	6214	" " " " Bracket with 49223 and 49224.....

NO.	PLATE	NAME
207D	6214	Thread (upper) Take-up Roller Bracket Screw.....
49224	6214	Thread (upper) Take-up Roller Pin.....
49246	—	Thread (upper) Take-up complete, Nos. 207D, 49226 and 49245.....
49239	6190	Throat Plate, for double thread, for 49138
49240	6190	“ “ with 665D and 49078, for single thread, for 49138.....
742F	6198	Throat Plate Screw.....
49078	6181	“ “ Thread Retainer.....
665D	6181	“ “ “ “ Screw.....

ACCESSORIES

NO.	PLATE	NAME
4718	6218	Machine Cushion.....
50144J	6199	“ Thumb Screw with 49095 for power table.....
49095	6199	Machine Thumb Screw Washer.....
120344	6201	Oiler (copper plated) with 120345.....
120345	6201	“ Spout, 5 in. long.....
11831	6201	Screw Driver (large).....
26026	6201	“ “ (small).....
120341	6201	Tweezers (curved).....
23766	6201	Wrench for 1508 and 1636.....
8909	6201	“ “ 1513 and 1517.....
8908	6201	“ “ 1519, 1708 and 1709.....
19221	6201	“ “ 1619.....
19079	6201	“ “ 1324 and 1629.....
49079	6201	“ “ 1714.....
49242	6201	“ “ 1740.....

EDGE FOLDERS

EDGE FOLDER

NO.	PLATE	NAME
36900	5676	Edge Folder (double).....
36901	5676	“ “ Hinge Plate.....
1423D	6219	“ “ Screw.....
36902	5676	“ “ Shank.....
78D	6219	“ “ “ Hinge Screw.....
2818	6219	“ “ “ “ “ Washer
36903	—	Edge Folder (double) complete, for burlap bags, Nos. 78D, 2818, 36900 to 36902 and two 1423D.....

EDGE FOLDER

FOR 92-1 AND 92-2 MACHINES

NO.	PLATE	NAME
36503	5676	Edge Folder.....
36504	5676	“ “ Hinge Plate.....
74D	6219	“ “ “ Screw.....
36505	5676	Edge Folder (double) swinging, complete, for burlap bags, Nos. 74D, 36503 and 36504.....

EDGE FOLDER ON SHANK

FOR 92-3 MACHINE

NO.	PLATE	NAME
36846	5676	Edge Folder, to turn right hand edge up, for burlap.....

HEMMER

NO.	PLATE	NAME
36436	6200	Hemmer on Shank, for burlap bags.....

FOOT LIFTER PARTS

NO.	PLATE	NAME
6439	—	Chain, 36 in. to 45 in., with 56864 and 56865.....

NOTE: When ordering No. 6439, give length required

4879	6218	Chain Connecting Link.....
56864	6220	“ Hook (large).....
56865	6219	“ “ (small).....
49160	6211	Lifting Lever.....
802D	6218	“ “ Hinge Screw.....
49161	6218	“ “ Link.....
50183D	6218	“ “ “ Hinge Screw.....
49162	6218	“ “ Spring.....
4881	6216	Treadle.....
4882	6218	“ Shaft.....
4883	6218	“ Spring.....
4884	6216	“ Stand.....
4885	6216	Treadle complete, Nos. 4879, 4881 to 4884 and two wood screws 1 in. No. 16.....
49164	—	Foot Lifter complete, Nos. 802D, 4885, 6439, 49160 to 49162 and 50183D.....

KNEE LIFTER PARTS

NO.	PLATE	NAME
49159	—	Chain, length 13½ in., with 39575 and 39576.....
39575	6205	Chain Hook (lower).....
39576	6205	“ “ (upper).....
49160	6211	Lifting Lever.....
802D	6218	“ “ Hinge Screw.....
49161	6218	“ “ Link.....
50183D	6218	“ “ “ Hinge Screw.....
49162	6218	“ “ Spring.....
7124	6216	Rock Shaft.....
2764	6216	“ “ Hanger (back) with two wood screws 1 in. No. 10.....
16128	6216	Rock Shaft Hanger (front) with two wood screws 1 in. No. 10.....
16646	6216	Rock Shaft Knee Arm.....
16647	—	Rock Shaft Knee Arm complete, Nos. 2766, 2767 and 16646.....
2766	6216	Rock Shaft Knee Arm Hub with 356c....
356C	6198	“ “ “ “ “ Set Screw....
2767	6216	“ “ “ Plate with 356c.....
356C	6198	“ “ “ “ “ Set Screw.....
6337	6216	“ “ Lifting Bracket with two 356c.....
6338	6216	“ “ “ “ Hook.....
356C	6198	“ “ “ “ “ Set Screw.....
356C	6198	“ “ “ “ “ Set Screw....
2770	6216	“ “ Stop Dog with 356c.....
356C	6198	“ “ “ “ “ Set Screw.....
16129	6216	Rock Shaft complete, Nos. 2764, 6337, 6338, 7124, 16128, 16647 and two 2770
49163	—	Knee Lifter complete, Nos. 802D, 16129, 49159 to 49162 and 50183D.....

MACHINE BASE

NO.	PLATE	NAME
49123	6199	Machine Base Oil Pipe.....
49124	6199	“ “ “ “ Valve.....
663E	6199	“ “ Screw.....
50144J	6199	“ “ Thumb Screw with 49095.....
49095	6199	“ “ “ “ Washer....
49096	6199	“ “ Washer (leather).....
49094	6216	“ “ with 49123, 49124 and three each 663E and 49096, for 92-1, 92-2 and 92-4 to 92-6 Machines.....
49193	6217	Machine Base with 49123, 49124 and three each 663E and 49096, for 92-3 Machine

THREAD UNWINDER

FOR TWO SPOOLS

NO.	PLATE	NAME
225395	7233	Spool Rest with 201018c.....
225388	7233	“ “ Rod.....
200383C	6219	“ “ “ Set Screw.....
201018C	6219	“ “ “ Set Screw.....
202490	7233	“ Stand with 200383c.....
225391	7233	Thread Guide.....
201696J	6219	“ “ Lock Nut.....
225392	7233	“ “ Rod with 208E and 225393
208E	6198	“ “ “ Screw.....
225393	6219	“ “ “ Washer.....
225396	7233	Thread Unwinder complete, Nos. 201696J, 202490, 225388, 225392, 225395, two 225391 and three wood screws 7⁄8 in. No. 12.....
27739	7234	Thread Cone (wood) for large cones....
225390	7234	“ “ “ Holder, for inverted cones..

NOTE: Nos. 27739 and 225390 are used with, but not included in 225396

Genuine Singer Needles and their Containers are marked with the Company's Trade Mark "SIMANCO." 1

Needles in Containers marked "For Singer Machines" are not Singer made needles. 2

NUMERICAL LIST OF PARTS

FOR

MACHINES

Nos. 92-1 to 92-6

NUMERICAL LIST OF PARTS

NO.	PLATE	NAME
74d	6219	Edge Folder Hinge Screw for 36505.....
78d	6219	“ “ Shank Hinge Screw for 36903
144d	6198	Arm Rotary Shaft Screw.....
145E	6198	Crank Connecting Rod Cap Screw for 49265
157d	6193	Looper Carrier Hinge Pin Clamping Screw for 49248.....
159E	6198	Arm Rotary Shaft Flanged Bushing (back) Screw.....
171E	6192	Looper Bell Crank Pitman Cap (lower) Screw for 49158.....
171E	6192	Looper Carrier Pitman Cap (left) Screw for 49088.....
171E	6192	Looper Carrier Pitman Cap (right) Screw for 49089.....
172c	6194	Feed Dog Screw.....
172f	6194	Thread (under) Eyelet Screw.....
175E	6192	Looper Carrier Clamping Screw for 49044 and 49260.....
175E	6192	Oil Cup Cover Screw for 49181.....
181d	6215	Thread (upper) Nipper Bracket Screw for 92-5 and 92-6 Machines.....
190d	6198	Presser Foot Screw.....
190d	6196	Thread (under) Take-up Screw.....
190d	6196	“ Guide (double) side of arm Screw for 92-3 Machine.....
193d	6181	Arm Rock Shaft Oil Cover Screw for 92-1 to 92-4 Machines.....
193E	6181	Face Plate Screw.....
194d	6200	Guide Screw Stud.....
195E	6206	Oil Cup Oil Hole Cover Screw for 49181..
198d	6206	“ Pipe Connection Cap Screw for 49188
202f	6192	Looper Carrier Hinge Pin Collar Set Screw for 49166.....
207d	6214	Thread (upper) Take-up Roller Bracket Screw for 49227 and 49246.....
208E	6198	Thread Unwinder Thread Guide Rod Screw for 225392.....
212d	6195	Presser Bar Lifter Cap Screw.....
212d	6195	“ “ Lifting Link Cap Screw.....
220d	6209	Feed Dog Stop Screw for 49021, 49110 and 49197.....
226d	6181	Looper Gate Lock Spring Screw for 49107, 49144, 49176 and 49196.....

NUMERICAL LIST OF PARTS

FOR

SEWING MACHINES

NO. 92-1 to 92-6

NO. PLATE	NAME
286d 6198	Arm Side Cover (back) Thumb Screw...
286d 6198	“ “ “ (front) “ “ ...
356c 6198	Rock Shaft Knee Arm Hub Set Screw for 2766.....
356c 6198	Rock Shaft Knee Plate Set Screw for 2767
356c 6198	“ “ Lifting Bracket Hook Set Screw for 6337.....
356c 6198	Rock Shaft Lifting Bracket Set Screw for 6337.....
356c 6198	Rock Shaft Stop Dog Set Screw for 2770
430c 6208	Arm Rock Shaft Flanged Bushing (front) Set Screw.....
430c 6208	Arm Rock Shaft Bushing (front) Set Screw
430c 6208	Balance Wheel Set Screw for 23873 and 46220.....
435c 6194	Needle Bar Bushing (lower) Set Screw...
435c 6195	Presser Bar Bushing (lower) Set Screw...
443c 6208	Arm Rock Shaft Collar Set Screw for 49006
446c 6208	“ “ “ Bushing (back) Set Screw
446c 6208	“ “ “ “ (intermediate) Set Screw.....
446c 6215	Arm Rock Shaft Collar and Thread (upper) Nipper Eccentric Set Screw for 49232..
448c 6181	Arm Rotary Shaft Flanged Bushing (intermediate) Set Screw.....
448c 6181	Looper Bell Crank Hinge Stud Set Screw
448c 6181	“ Gate Hinge Pin Set Screw for 49116 and 49212.....
453c 6193	Looper Carrier Rock Shaft Collar Set Screw for 11411.....
453c 6195	Presser Bar Lifter Hinge Stud Set Screw.
453c 6195	“ “ Lifting Bracket Set Screw for 49065.....
457c 6196	Feed Bar Hinge Pin Set Screw for 49021, 49110 and 49197.....
457c 6196	Feed Connecting Rod Hinge Pin Set Screw for 49202.....
457c 6196	Feed Lifting Eccentric Connection Hinge Pin Set Screw for 49253.....
457c 6196	Thread (upper) Take-up Set Screw for 49075.....
457c 6196	Thread (upper) Take-up Arm Set Screw for 49225 and 49245.....
574w 6198	Pressure Regulating Thumb Screw.....
590b 6192	Looper Thread Guard Screw for 49036, 49209 and 49233.....
622c 6198	Feed Rock Shaft Hinge Pin Screw Bearing
663E 6199	Machine Base Screw for 49094 and 49193

NO. PLATE	NAME
665d 6181	Throat Plate Thread Retainer Screw for 49130, 49132, 49148, 49150, 49152, 49155, 49229, 49240 and 49270.....
671d 6200	Guide Thumb Screw.....
690d 6206	Oil Cup Screw for 92-3 Machine.....
691F 6198	Throat Plate Screw for 92-1 and 92-3 Machines.....
701e 6219	Needle Bar Connecting Stud Clamping Screw for 49268.....
724d 6195	Presser Bar Lifting Link Hinge Screw....
725f 6181	Cloth Plate Slide Spring Screw for 49017
742f 6198	Throat Plate Screw for 92-2 and 92-4 to 92-6 Machines.....
802b 6218	Lifting Lever Hinge Screw for 49163 and 49164.....
892f 6195	Presser Bar Lifting Bracket Adjusting Screw for 49065.....
896E 6209	Feed Connecting Rod Cap Screw for 49023 and 49198.....
896E 6209	Feed Lifting Eccentric Connection Cap Screw for 49253.....
896E 6209	Feed Rock Shaft Crank Clamping Screw for 49115 and 49208.....
914c 6196	Feed Regulator Connection Screw for 49202.....
914f 6196	Thread (upper) Controller Screw.....
916c 6194	Tension (under thread) Screw Stud for 44209.....
916f 6194	Tension (upper thread) Screw Stud for 44209.....
931E 6213	Feed Regulating Screw Stop Screw Bushing for 92-4 and 92-5 Machines.....
974f 6196	Thread (upper) Controller Hinge Screw..
1036c 6193	Looper Eccentric Set Screw for 49142....
1057E 6209	“ Bell Crank Pitman Cap (upper) Screw for 49158.....
1133E 6194	Needle Bar Bushing (upper) Set Screw...
1133E 6195	Presser Bar Bushing (upper) Set Screw...
1147c 6192	Looper Carrier Pitman Ball Stud (left) Set Screw.....
1147c 6192	Looper Set Screw for 49044 and 49260....
1177E 6219	Feed Rock Shaft Crank Clamping Screw for 49267.....
1259c 6209	Arm Rotary Shaft Collar Set Screw for 49010.....
1259c 6209	Feed Eccentric Set Screw for 49026 and 49112.....

NO.	PLATE	NAME
1259c	6209	Feed Lifting Eccentric Set Screw for 49027 and 49113.....
1324E	6193	Looper Carrier Rock Shaft Crank (front) Clamping Screw for 49248.....
1423D	6219	Edge Folder Screw for 36903.....
1454E	---	Needle Bar Connecting Stud Clamping Screw for 49217.....
1508J	6198	Feed Rock Shaft Hinge Pin Nut.....
1508J	6198	" " " " " Screw Bearing Nut.....
1513J	6198	Crank Connecting Rod Hinge Screw Nut for 49266.....
1517J	6194	Needle Bar Connecting Link Hinge Stud Nut.....
1519J	6192	Looper Carrier Pitman Ball Screw Stud Nut.....
1539W	6198	Pressure Regulating Thumb Screw Lock Nut.....
1560c	6194	Tension (under thread) Regulating Thumb Nut for 44209.....
1560c	6194	Tension (upper thread) Regulating Thumb Nut for 44209.....
1560c	6215	Thread (upper) Nipper Regulating Thumb Nut for 49244.....
1619E	6208	Looper Bell Crank Pitman Ball Screw Stud (upper) Nut.....
1629c	6194	Needle Clamping Nut for 92-1 to 92-3, 92-5 and 92-6 Machines.....
1636c	6198	Looper Bell Crank Pitman Ball Screw Stud (lower) Nut.....
1708E	6192	Looper Carrier Pitman Rod Nut (left) for 49045.....
1709E	6192	Looper Carrier Pitman Rod Nut (right) for 49045.....
1714c	6181	Feed Regulating Screw Stud Nut for 92-1 to 92-3 and 92-6 Machines.....
1733D	6206	Oil Pipe Coupling Nut for 92-3 Machine.....
1740c	6214	Needle Clamping Nut for 92-4 Machine.....
2102	6194	Tension (under thread) Disc.....
2102	6194	" (upper thread) Disc.....
2102	6215	Thread (upper) Nipper Disc for 49244.....
2653	6206	Arm Oil Tube Packing Stop Pin for 49170 to 49172.....
2653	6206	Feed Connecting Rod Oil Pad Pin for 49023.....
2653	6206	Feed Lifting Eccentric Connection Oil Pad Pin for 49253.....

NO.	PLATE	NAME
2764	6216	Rock Shaft Hanger (back) with two wood screws 1 in. No. 10, for 16129.....
2766	6216	Rock Shaft Knee Arm Hub with 356c, for 16617.....
2767	6216	Rock Shaft Knee Plate with 356c, for 16617.....
2770	6216	Rock Shaft Stop Dog with 356c, for 16129.....
2818	6219	Edge Folder Shank Hinge Screw Washer for 36903.....
4288	6179	Arm Side Cover (back).....
4288	6179	" " " (front) for 92-1, 92-2 and 92-4 to 92-6 Machines.....
4718	6218	Machine Cushion (Accessories).....
4784	6192	Feed Connecting Rod Oil Pad (felt) for 49023 and 49198.....
4784	6192	Looper Bell Crank Oil Pad (felt) for 49038.....
4784	6192	" Carrier Oil Pad (felt) for 49044 and 49211.....
4879	6218	Chain Connecting Link for 4885.....
		Nos. 4881 to 4884 for 4885
4881	6216	Treadle.....
4882	6218	" Shaft.....
4883	6218	" Spring.....
4884	6216	" Stand.....
4885	6216	Treadle complete for 49164, Nos. 4879, 4881 to 4884 and two wood screws 1 in. No. 16.....
6337	6216	Rock Shaft Lifting Bracket with two 356c, for 16129.....
6338	6216	Rock Shaft Lifting Bracket Hook for 16129.....
6439	----	Chain, 36 in. to 45 in., with 56864 and 56865, for 49164.....
7124	6216	Rock Shaft for 16129.....
8908	6201	Wrench for 1519, 1708 and 1709 (Accessories).....
8909	6201	Wrench for 1513 and 1517 (Accessories).....
10148	6194	Tension (under thread) Spring.....
11119	6205	Arm Oil Tube with 52045, for oiling 49101.....
11398	6179	Feed Rock Shaft Hinge Pin.....
11411	6193	Looper Carrier Rock Shaft Collar with 453c.....
11831	6201	Screw Driver, large (Accessories).....
13710	6194	Tension (upper thread) Spring.....
16128	6216	Rock Shaft Hanger (front) with two wood screws 1 in. No. 10, for 16129.....

NO.	PLATE	NAME
16129	6216	Rock Shaft complete for 49163, Nos. 2764, 6337, 6338, 7124, 16128, 16647 and two 2770.....
16646	6216	Rock Shaft Knee Arm for 16647.....
16647	—	Rock Shaft Knee Arm complete for 16129, Nos. 2766, 2767 and 16646.....
17677	6207	Arm Side Cover (front) for 92-3 Machine
18130	6205	" Oil Tube with 52045 for front bearing
18130	6205	" " " " 52045 for intermediate bearing.....
18130	6205	Arm Oil Tube with 52045, for oiling 49049, for 92-1, 92-2 and 92-4 to 92-6 Machines
18144	6219	Arm Rotary Shaft Oil Pad (felt) for 92-1 and 92-2 Machines.....
19079	6201	Wrench for 1324 and 1629 (Accessories).....
19221	6201	" " 1619 (Accessories).....
23766	6201	" " 1508 and 1636 (Accessories).....
23873	6210	Balance Wheel, 2 1/8 in. pulley, with two 430c, for 92-1 to 92-3, 92-5 and 92-6 Machines.....
26026	6201	Screw Driver, small (Accessories).....
27398	6181	Feed Rock Shaft Washer.....
27739	7234	Thread Unwinder Thread Cone (wood) for large cones, for 225396.....
32572	6215	Thread (upper) Nipper Releasing Disc for 49244.....
36221	6200	Guide for 92-3 Machine.....
36421	6200	" for 92-1, 92-2 and 92-4 to 92-6 Machines.....
36436	6200	Hemmer on Shank, for burlap bags.....
36503	5676	Edge Folder for 36505.....
36504	5676	" " Hinge Plate for 36505.....
36505	5676	Edge Folder (double) swinging, complete, for burlap bags, for 92-1 and 92-2 Machines, Nos. 74b, 36503 and 36504.....
36846	5676	Edge Folder on Shank, to turn right hand edge up, for burlap, for 92-3 Machine.....
		Nos. 36900 to 36902 for 36903
36900	5676	Edge Folder (double).....
36901	5676	" " Hinge Plate.....
36902	5676	" " Shank.....
36903	—	Edge Folder (double) complete, for burlap bags, Nos. 78b, 2818, 36900 to 36902 and two 1423b.....
38419	6181	Cloth Plate Slide Spring for 49017.....
38468	6195	Presser Bar Spring Stud.....

NO.	PLATE	NAME
39541	6196	Thread (upper) Controller Screw Washer
39575	6205	Chain Hook (lower) for 49159.....
39576	6205	" " (upper) for 49159.....
44209	—	Tension (under thread) Screw Stud 916c with 1560c.....
44209	—	Tension (upper thread) Screw Stud 916c with 1560c.....
46220	6210	Balance Wheel, 2 1/8 in. pulley, with two 430c, for 92-4 Machine.....
*46223	—	Looper Bell Crank Pitman Cap (upper) for 49158.....
46221	6206	Cloth Plate Oil Cup for 49175.....
46237	6192	Looper Carrier Pitman Ball Stud (left) for 46241 and 49088.....
*49001	—	Arm, upper and lower (solid) for 92-1, 92-2 and 92-4 Machines.....
49003	6208	Arm Rock Shaft Bushing (back).....
49004	6208	" " " " (intermediate)
49005	6208	" " " Flanged Bushing (front)
49006	6208	" " " Collar with two 443c, for 92-1 to 92-4 Machines.....
49010	6209	Arm Rotary Shaft Collar with two 1259c
49011	6181	" " " Bushing (front).....
49012	6179	" " " Flanged Bushing (back) with 49013 and 49093.....
49013	6205	Arm Oil Tube Packing (braided cotton) for 49169.....
49013	6205	Arm Rotary Shaft Flanged Bushing (back) Oil Pad (short) braided cotton, for 49012.....
49013	6205	Arm Rotary Shaft Oil Pad (braided cotton) for front bearing, for 92-3 to 92-6 Machines.....
49013	6205	Arm Rotary Shaft Oil Pad (braided cotton) for intermediate bearing for 92-3, 92-5 and 92-6 Machines.....
49013	6205	Feed Rock Shaft Oil Cup Packing (braided cotton) for 49179.....
49014	6181	Arm Rotary Shaft Flanged Bushing (intermediate).....
49016	—	Cloth Plate Slide for 49017.....
49017	6179	Cloth Plate Slide complete for 49107, 49144, 49176 and 49196, Nos. 38419, 49016 and two 725.....
49020	6179	Face Plate.....
49021	6209	Feed Bar with 220b and 457c, for 92-1 and 92-3 Machines.....

NO.	PLATE	NAME
49022	6209	Feed Bar Hinge Pin.....
49023	6209	" Connecting Rod with 2653, 4784, 49024 and two 896e, for 92-1 to 92-3 and 92-6 Machines.....
*49024	---	Feed Connecting Rod Cap for 49023.....
49025	6182	" Dog, 15 teeth (10 teeth to the inch) for large bags, for 92-1 and 92-3 Ma- chines.....
49026	6209	Feed Eccentric with two 1259c, for 92-1 and 92-3 Machines.....
49027	6197	Feed Lifting Eccentric with two 1259c, for 92-1 Machine.....
*49029	---	Feed Lifting Eccentric Connection Cap for 49253.....
49030	6209	Feed Lifting Eccentric Connection Hinge Pin.....
49031	6181	Feed Regulating Screw Stud Sleeve for 92-1 to 92-3 and 92-6 Machines.....
49032	6181	Feed Regulating Screw Stud Washer for 92-1 to 92-3 and 92-6 Machines.....
49033	6179	Feed Rock Shaft for 49031, 49114 and 49207.....
49034	---	Feed Rock Shaft complete for 92-1 Machine, Nos. 49033 and 49267.....
49036	6192	Looper (double thread) with 590b and 49080, for 92-1 to 92-3 Machines.....
49037	6192	Looper (single thread) for 92-1 to 92-3, 92-5 and 92-6 Machines.....
49038	6207	Looper Bell Crank 49257 with 4784.....
49039	6207	" " " Hinge Stud.....
*49041	---	" " " Pitman Cap (lower) for 49158.....
49043	6192	Looper Bell Crank Pitman Washer (fibre)
49043	6192	" Carrier Pitman Washer (fibre)....
49044	6192	" " with 4784 and two each 175e, 1147c and 59019, for 49194.....
49045	6192	Looper Carrier Pitman complete, Nos. 1708e, 1709e, 49046, 49088 and 49089
49046	6192	Looper Carrier Pitman Rod for 49045....
49047	6193	" " Rock Shaft.....
49048	6193	" " " " Crank (back) forked, with 50083c.....
49049	6193	Looper Carrier Rock Shaft Crank (back) Slide Block for 49258.....
49053	6181	Looper Gate Hinge Pin for 49107, 49114, 49176 and 49196.....

NO.	PLATE	NAME
49054	6181	Looper Gate Lock Spring for 49107, 49114, 49176 and 49196.....
49055	6194	Needle Bar (hollow) for 92-1 to 92-3, 92-5 and 92-6 Machines.....
49056	6194	Needle Bar Bushing (lower) for 92-1 and 92-3 Machines.....
49056	6194	Needle Bar Bushing (upper) for 92-1 to 92-3, 92-5 and 92-6 Machines.....
49057	6194	Needle Bar Connecting Link Hinge Stud for 49167 and 49252.....
49059	6195	Presser Bar.....
49060	6195	" " Bushing (lower).....
49061	6195	" " " (upper).....
49062	6195	" " Lifter.....
49063	6195	" " " Friction Washer.....
49064	6195	" " " Hinge Stud.....
49065	6195	" " Lifting Bracket with 453c and 892f.....
49066	6195	Presser Bar Lifting Link.....
49067	6179	" " Spring (flat).....
49068	---	" Foot Plate for 49070.....
49069	---	Presser Foot Shank for 49070.....
49070	6182	Presser Foot (hinged) complete for 49025, 49103 and 49146, Nos. 49068, 49069 and 50087f.....
49071	6194	Thread (under) Eyelet for 92-1 to 92-3 Machines.....
49072	6196	Thread (under) Take-up for 92-1 to 92-3 Machines.....
49073	6196	Thread (upper) Controller.....
49075	6196	" " Take-up with 457c, for 92-1 to 92-3 Machines.....
49078	6181	Throat Plate Thread Retainer for 49130, 49132, 49148, 49150, 49152, 49155, 49229, 49240 and 49270.....
49079	6201	Wrench for 1714 (Accessories).....
49080	6192	Looper Thread Guard for 49036.....
49082	6188	Presser Foot for 49153.....
49084	6181	Arm Rock Shaft Oil Cover for 92-1 to 92-4 Machines.....
*49085	---	Looper Carrier Pitman Cap (left) for 49088.....
*49085	---	Looper Carrier Pitman Cap (right) for 49089.....
*49086	---	Looper Carrier Pitman End Bearing (left) for 49088.....

NUMERICAL LIST OF PARTS

NO.	PLATE	NAME
*49087	---	Looper Carrier Pitman End Bearing (right) for 49089.....
49088	6192	Looper Carrier Pitman Head (left) for 49045, Nos. 46237, 49085, 49086 and two 171E.....
49089	6192	Looper Carrier Pitman Head (right) for 49045, Nos. 49085, 49087, 50070c and two 171E.....
49091	6205	Arm Oil Tube with 49092, for oiling 49265 (lower bearing).....
49092	6205	Arm Oil Tube Packing (felt) for 49091.....
49093	6205	" Rotary Shaft Flanged Bushing (back) Oil Pad, long (braided cotton) for 49012.....
49094	6216	Machine Base with 49123, 49124 and three each 663E and 49096, for 92-1, 92-2 and 92-4 to 92-6 Machines.....
49095	6199	Machine Base Thumb Screw Washer for 50144.....
49095	6199	Machine Thumb Screw Washer for 50144.....
49096	6199	" Washer (leather) for 49094 and 49193.....
49097	6207	Arm Rotary Shaft for 49263.....
*49099	---	Crank Connecting Rod Cap for 49265.....
*49101	6194	Needle Bar Connecting Link for 49167 and 49252.....
49103	6182	Feed Dog (spiked teeth) 15 teeth (10 teeth to the inch) for clay filled bags, for 92-1 and 92-3 Machines.....
49105	6211	Arm Rotary Shaft for 49264.....
49106	6175	Cloth Plate for 49107.....
49107	---	Cloth Plate complete for 92-1 Machine, Nos. 49017, 49053, 49054, 49106, 49116 and two 226b.....
49110	6197	Feed Bar with 220b and 457c, for 92-2 and 92-6 Machines.....
49111	6185	Feed Dog, 14 teeth (7 teeth to the inch) for heavy bags, for 92-2 Machine and 36436 for the same machine.....
49112	6197	Feed Eccentric with two 1259c, for 92-2 and 92-4 to 92-6 Machines.....
49113	6197	Feed Lifting Eccentric with two 1259c for 92-2 to 92-6 Machines.....
49114	---	Feed Rock Shaft complete for 92-2 and 92-6 Machines, Nos. 49033 and 49115.....
49115	6179	Feed Rock Shaft Crank with two 896E, for 49114.....

NUMERICAL LIST OF PARTS

NO.	PLATE	NAME
49116	6210	Looper Gate with 448c, for 49107 and 49176.....
49117	6197	Needle Bar Bushing (lower) for 92-2, 92-5 and 92-6 Machines.....
49118	---	Presser Foot Plate for 49120.....
49119	---	" " Shank for 49120, 49219 and 49235.....
49120	6185	Presser Foot (hinged) complete for 49111, Nos. 49118, 49119 and 50087E.....
49123	6199	Machine Base Oil Pipe for 49094 and 49193.....
49124	6199	" " " " Valve for 49094 and 49193.....
49125	6184	Feed Dog (double) 17 teeth (12 teeth to the inch) for 92-1 and 92-3 Machines and 36436 for the same machines.....
49126	---	Presser Foot Plate for 49128.....
49127	---	" " Shank for 49128.....
49128	6184	Presser Foot (hinged) complete for 49025, 49125 and 49138, Nos. 49126, 49127 and 50087E.....
49129	6184	Throat Plate, for double thread, for 49125.....
49130	6184	" " with 665b and 49078, for single thread, for 49125.....
49131	6182	Throat Plate, for double thread, for 49025 and 49103.....
49132	6182	Throat Plate with 665b and 49078, for single thread, for 49025 and 49103.....
49138	6190	Feed Dog, 17 teeth (14 teeth to the inch) for medium and light bags, for 92-2, 92-5 and 92-6 Machines and 36436 for the same machines.....
49141	6213	Arm Oil Tube with 56006, for oiling 49265 (upper bearing) for 92-1, 92-2 and 92-4 to 92-6 Machines.....
49142	6193	Looper Eccentric with two 1036c, for 49258.....
49143	6210	Cloth Plate for 49144.....
49144	---	Cloth Plate complete, for 92-2 and 92-6 Machines, Nos. 49017, 49053, 49054, 49143, 49212 and two 226b.....
49146	6223	Feed Dog, 15 teeth (10 teeth to the inch) for 92-2 Machine.....
49147	6223	Throat Plate, for double thread, for 49146.....
49148	6223	" " with 665b and 49078, for single thread, for 49146.....
49149	6221	Throat Plate, for double thread, for 49111.....
49150	6221	" " with 665b and 49078, for single thread, for 49111.....

NO.	PLATE	NAME
49151	6222	Throat Plate for double thread, for 49138
49152	6222	“ “ with 665D and 49078, for single thread, for 49138.
49153	6188	Feed Dog. 16 teeth (14 teeth to the inch) for small bags, for 92-1 and 92-3 Machines.
49154	6188	Throat Plate, for double thread, for 49153
49155	6188	“ “ with 665D and 49078, for single thread, for 49153.
49156	6207	Arm Rock Shaft for 49271
49158	6207	Looper Bell Crank Pitman with 46223, 49041 and two each 171E and 1057E, for 49250.
49159	—	Chain, length 13½ in., with 39575 and 39576, for 49163.
Nos. 49160 to 49162 FOR 49163 AND 49164		
49160	6211	Lifting Lever
49161	6218	“ “ Link
49162	6218	“ “ Spring
49163	—	Knee Lifter complete, Nos. 802D, 16129, 49159 to 49162 and 50183D.
49164	—	Foot Lifter complete, Nos. 802D, 4885, 6439, 49160 to 49162 and 50183D.
49165	6192	Looper Carrier Hinge Pin for 49194 and 49247.
49166	6192	Looper Carrier Hinge Pin Collar with two 202E, for 49194 and 49247.
49167	—	Needle Bar Connecting Link 49101 with 49057 and 49268. for 92-1 to 92-3, 92-5 and 92-6 Machines.
Nos. 49168 TO 49181 FOR 92-3 MACHINE		
*49168	—	Arm, upper and lower (solid).
49169	6206	“ Oil Tube with 49013, for oiling 49049
49170	6206	“ “ “ “ 2653 and 49174, for oiling 46223.
49171	6206	Arm Oil Tube with 2653 and 49174, for oiling 49265 (upper bearing).
49172	6206	Arm Oil Tube with 2653 and 49174, for oiling 49023.
49173	6206	Arm Oil Tube Oil Cup Holder with 54897 for 49169.
49174	6206	Arm Oil Tube Packing (braided cotton) for 49170 to 49172.
49175	6210	Cloth Plate with two 46224, for 49176.

NO.	PLATE	NAME
49176	—	Cloth Plate complete, Nos. 49017, 49053, 49054, 49116, 49175 and two 226D.
49177	6211	Feed Rock Shaft for 49178.
49178	—	Feed Rock Shaft complete, Nos. 49177, 49179 and 49267.
49179	6209	Feed Rock Shaft Oil Cup with 49013, for 49178.
49180	6212	Oil Cup for 49181.
49181	—	Oil Cup complete, Nos. 195E, 49180, 49182 to 49184 and two 175E.
Nos. 49182 TO 49184 FOR 49181		
49182	6212	Oil Cup Cover
49183	6206	“ “ Oil Hole Cover
49184	6212	“ “ “ Strainer
Nos. 49185 TO 49193 FOR 92-3 MACHINE		
49185	6212	Oil Pipe with 49191, for oiling 49265.
49186	6212	“ “ “ 49191, for oiling 49012.
49187	6212	“ “ “ 49191, for oiling 49011 and 49014.
49188	6206	Oil Pipe Connection with 49189 and two 198D, for 49187, for oiling 49014.
*49189	—	Oil Pipe Connection Cap for 49188.
49190	6206	“ “ Coupling
49191	6206	“ “ Sleeve for 49185 to 49187.
49192	6206	Thread Guide (double) side of arm
49193	6217	Machine Base with 49123, 49124 and three each 663E and 49096.
49194	—	Looper Carrier 49014 with 49165, 49166 and 49248, for 92-1 to 92-3 and 92-6 Machines.
Nos. 49195 TO 49200 FOR 92-4 AND 92-5 MACHINES		
49195	6210	Cloth Plate for 49196.
49196	—	Cloth Plate complete, Nos. 49017, 49053, 49054, 49195, 49212 and two 226D.
49197	6213	Feed Bar with 220D and 457C for 92-4 and 92-5 Machines.
49198	6213	Feed Connecting Rod with 4784, 49199, 49244 and two 896E.
*49199	—	Feed Connecting Rod Cap for 49198.
49200	6213	“ “ “ Hinge Pin
49201	6189	“ Dog, 14 teeth (7 teeth to the inch) for 92-4 Machine and 36436 for the same machine.

NO.	PLATE	NAME
Nos. 49202 TO 49208 FOR 92-4 AND 92-5 MACHINES		
49202	6213	Feed Regulator with 457c and 914c.....
49203	6213	“ “ Connection.....
49204	6213	“ Regulating Screw Friction Washer..
49205	6213	“ “ “ Washer (fibre)...
49206	6213	“ “ “ “ (steel)...
49207	—	Feed Rock Shaft complete, Nos. 49033 and 49208.....
49208	6213	Feed Rock Shaft Crank with two 896E, for 49207.....
49209	6214	Looper (double thread) with 590b and 49213, for 92-4 Machine.....
49210	6214	Looper (single thread) for 92-4 Machine..
49211	6214	“ Carrier 49260 with 4784 for 49247
49212	6210	“ Gate with 448c, for 49144 and 49196.....
49213	6214	Looper Thread Guard for 49209 and 49233
Nos. 49214 TO 49217 FOR 92-4 MACHINE		
49214	6214	Needle Bar (hollow).....
49215	6214	“ “ Bushing (lower).....
49216	6214	“ “ “ (upper).....
49217	6214	“ “ Connecting Stud with 1454E for 49252.....
49218	—	Presser Foot Plate for 49219.....
49219	6189	Presser Foot (hinged) complete for 49201, Nos. 49119, 49218 and 50087F.....
49220	6214	Tension (under thread) Thread Guide....
49220	6214	“ (upper thread) Thread Guide....
49221	6214	Thread (under) Eyelet for 92-4 to 92-6 Machines.....
49222	6214	Thread (under) Take-up with 49223 and 49224 for 92-4 to 92-6 Machines.....
49223	6214	Thread (under) Take-up Roller for 49222
49223	6214	“ (upper) Take-up Roller for 49226
49224	6214	“ (under) Take-up Roller Pin for 49222.....
49224	6214	Thread (upper) Take-up Roller Pin for 49226.....
49225	6214	Thread (upper) Take-up Arm with 457c for 49227.....
49226	6214	Thread (upper) Take-up Roller Bracket with 49223 and 49224, for 49227 and 49246.....
49227	—	Thread (upper) Take-up complete for 92-4 Machine, Nos. 207b, 49225 and 49226...

NO.	PLATE	NAME
49228	6189	Throat Plate, for double thread, for 49201
49229	6189	“ “ with 665b and 49078, for single thread, for 49201.....
Nos. 49231 TO 49233 FOR 92-5 AND 92-6 MACHINES		
*49231	—	Arm, upper and lower (solid).....
49232	6215	“ Rock Shaft Collar and Thread (upper) Nipper Eccentric with two 446c.....
49233	6215	Looper (double thread) with 590b and 49213.....
49234	—	Presser Foot Plate for 49235.....
49235	6190	Presser Foot (hinged) complete for 49138, Nos. 49119, 49234 and 50087F.....
49236	6215	Thread (upper) Nipper Bracket for 49244
49237	6215	“ “ “ Releasing Stud for 92-5 and 92-6 Machines.....
49238	6215	Thread (upper) Nipper Thread Guide for 49244.....
49239	6190	Throat Plate, for double thread, for 49138
49240	6190	“ “ with 665b and 49078, for single thread, for 49138.....
49241	6213	Feed Connecting Rod Oil Pad Pin for 49198.....
49242	6201	Wrench for 1710 (Accessories).....
49244	—	Thread (upper) Nipper complete for 92-5 and 92-6 Machines, Nos. 1560c, 32572, 49236, 49238, 50133c, 54738 and two 2102.....
49245	6215	Thread (upper) Take-up Arm with 457c, for 49246.....
49246	—	Thread (upper) Take-up complete for 92-5 and 92-6 Machines, Nos. 207b, 49226 and 49245.....
49247	—	Looper Carrier 49211 with 49165, 49166 and 49248, for 92-4 and 92-5 Machines.
49248	6193	Looper Carrier Rock Shaft Crank (front) with 157b and two 1324E, for 49194 and 49247.....
49250	—	Looper Bell Crank Pitman 49158 with 50069c and 50070c.....
49252	—	Needle Bar Connecting Link 49101 with 49057 and 49217, for 92-4 Machine....
49253	6219	Feed Lifting Eccentric Connection with 457c, 2653, 49029, 55515 and two 896E
*49257	—	Looper Bell Crank for 49038.....
49258	—	“ Eccentric 49142 with 49049.....

NO.	PLATE	NAME
*49260	----	Looper Carrier with two each 175E, 1147c and 59019, for 49211
49261	6219	Arm Rock Shaft Crank (back) with 50282e and 50457c, for 49271
49262	6219	Arm Rock Shaft Crank (front) with 50282e and 50457c
49263	----	Arm Rotary Shaft 49097 with 49266, for 92-1 and 92-3 Machines
49264	----	Arm Rotary Shaft 49105 with 49266, for 92-2, 92-4 to 92-6 Machines
49265	6220	Crank Connecting Rod with 49099 and two 145e, for 49266
49266	----	Crank Connecting Rod 49265 with 1513a and 50147c for 49263 and 49264
49267	6220	Feed Rock Shaft Crank with two 1177e, for 49034 and 49178
49268	6219	Needle Bar Connecting Stud with 701e, for 49167
49269	6224	Throat Plate, for double thread, for 49125
49270	6224	“ “ with 665b and 49078, for single thread, for 49125
49271	----	Arm Rock Shaft 49156 with 49261
50069c	6208	Looper Bell Crank Pitman Ball Screw Stud (upper) for 49250
50070c	6192	Looper Bell Crank Pitman Ball Screw Stud (lower) for 49250
50070c	6192	Looper Carrier Pitman Ball Screw Stud for 49089
50083c	6193	Looper Carrier Rock Shaft Crank (back) Set Screw for 49048
50085f	6198	Cloth Plate Screw for 92-1 and 92-3 Machines
50086c	6181	Feed Regulating Screw Stud for 92-1 to 92-3 and 92-6 Machines
50087f	6198	Presser Foot Hinge Screw for 49070, 49120 49128, 49219 and 49235
50133c	6215	Thread (upper) Nipper Screw Stud for 49244
50144i	6199	Machine Base Thumb Screw with 49095
50144j	6199	“ “ Thumb Screw with 49095, for power table (Accessories)
50147c	6198	Crank Connecting Rod Hinge Screw for 49266
50175f	6213	Cloth Plate Screw for 92-2 and 92-4 to 92-6 Machines
50183b	6218	Lifting Lever Link Hinge Screw for 49163 and 49164

NO.	PLATE	NAME
50249e	6206	Arm Rotary Shaft Oil Pad Cap Screw for 92-3 Machine
50282e	6208	Arm Rock Shaft Crank (back) Set Screw for 49261
50282e	6208	Arm Rock Shaft Crank (front) Set Screw for 49262
50331e	6213	Feed Regulating Screw for 92-4 and 92-5 Machines
50457c	6219	Arm Rock Shaft Crank (back) Position Screw for 49261
50457c	6219	Arm Rock Shaft Crank (front) Position Screw for 49262
52045	6197	Arm Oil Tube Packing (braided cotton) for 11119 and 18130
54738	6215	Thread (upper) Nipper Spring for 49244
54897	6206	Arm Oil Tube Oil Cup for 49173
55515	6219	Feed Lifting Eccentric Connection Oil Pad (braided cotton) for 49253
56006	6197	Arm Oil Tube Packing (braided cotton) for 49141
56861	6220	Chain Hook (large) for 6439
56865	6219	“ “ (small) for 6439
59019	6197	Looper Carrier Gib for 49044 and 49260 ..
120344	6201	Tweezers, curved (Accessories)
120344	6201	Oiler (copper plated) with 120345 (Accessories)
120345	6201	Oiler Spout, 5 in. long, for 120344
200383c	6219	Thread Unwinder Spool Rest Rod Set Screw for 202490
201018c	6219	Thread Unwinder Spool Rest Set Screw for 225395
201696i	6219	Thread Unwinder Thread Guide Lock Nut for 225396
202490	7233	Thread Unwinder Spool Stand with 200383c for 225396
225388	7233	Thread Unwinder Spool Rest Rod for 225396
Nos. 225390 to 225392 for 225396		
225390	7234	Thread Unwinder Thread Cone Holder, for inverted cones
225391	7233	Thread Unwinder Thread Guide
225392	7233	“ “ “ “ Rod with 208e and 225393
225393	6219	Thread Unwinder Thread Guide Rod Washer for 225392

NUMERICAL LIST OF PARTS

NO.	PLATE	NAME
225395	7233	Thread Unwinder Spool Rest with 201018c, for 225396.....
225396	7233	Thread Unwinder complete, for two spools, Nos. 2016961, 202490, 225388, 225392, 225395, two 225391 and three wood screws 7/8 in. No. 12.....

Genuine Singer Needles and their Containers are marked with the Company's Trade Mark "SIMANCO." 1

Needles in Containers marked "For Singer Machines" are not Singer made needles. 2

ILLUSTRATIONS OF PARTS

FOR

MACHINES

Nos. 92-1 to 92-6

36900

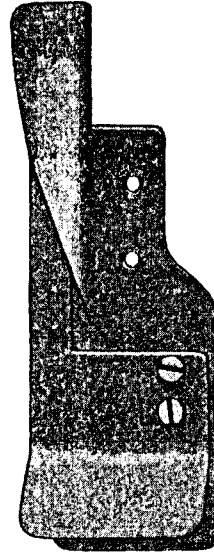

36902

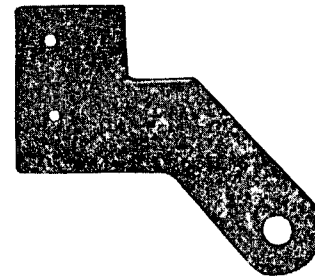

36901

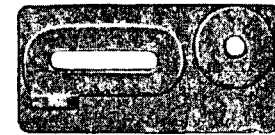

36505

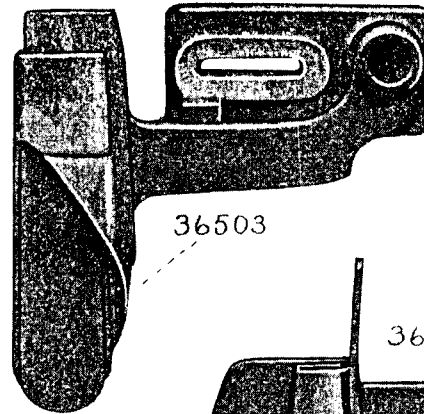

36504

36503

36846

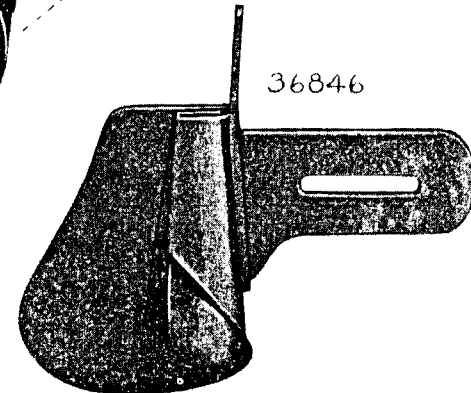

INSTRUCTIONS OF PARTS

FOR

MACHINES

0-28 of 1-28 1959

PLATE 6175—ONE-FOURTH SIZE

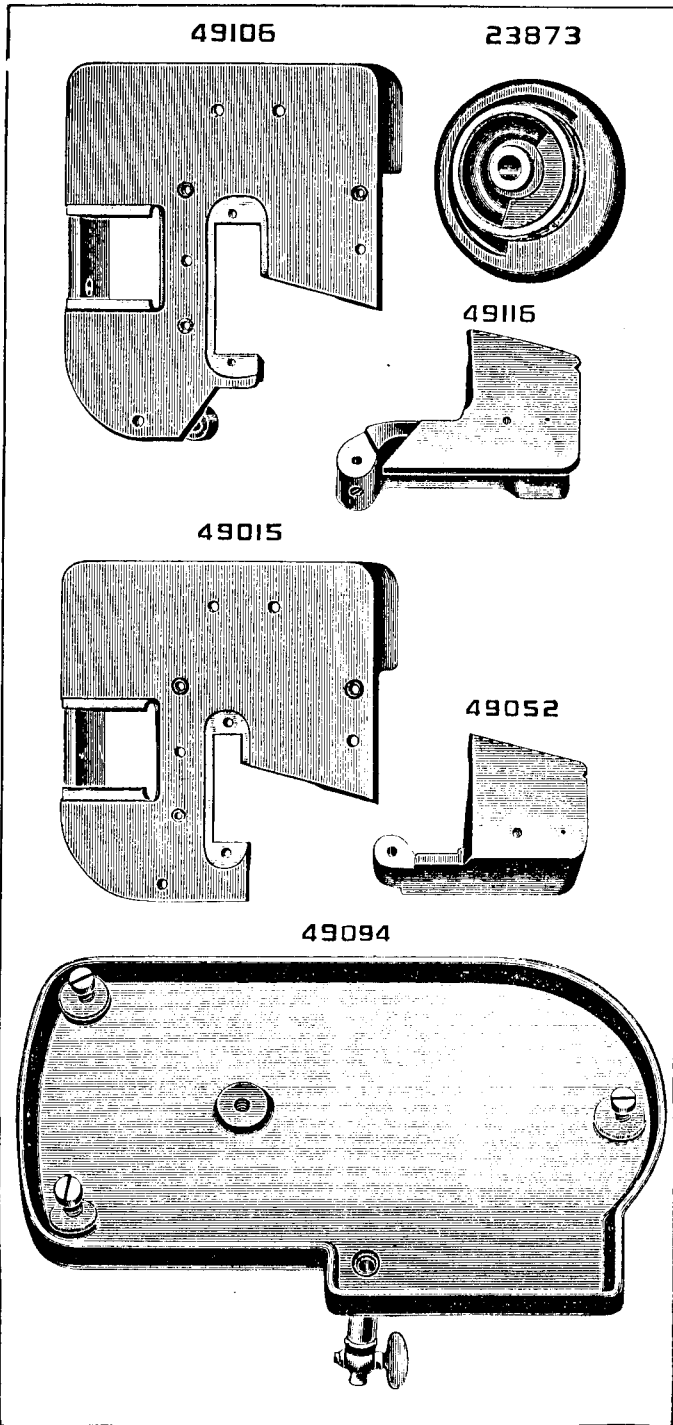

PLATE 6179—ONE-HALF SIZE

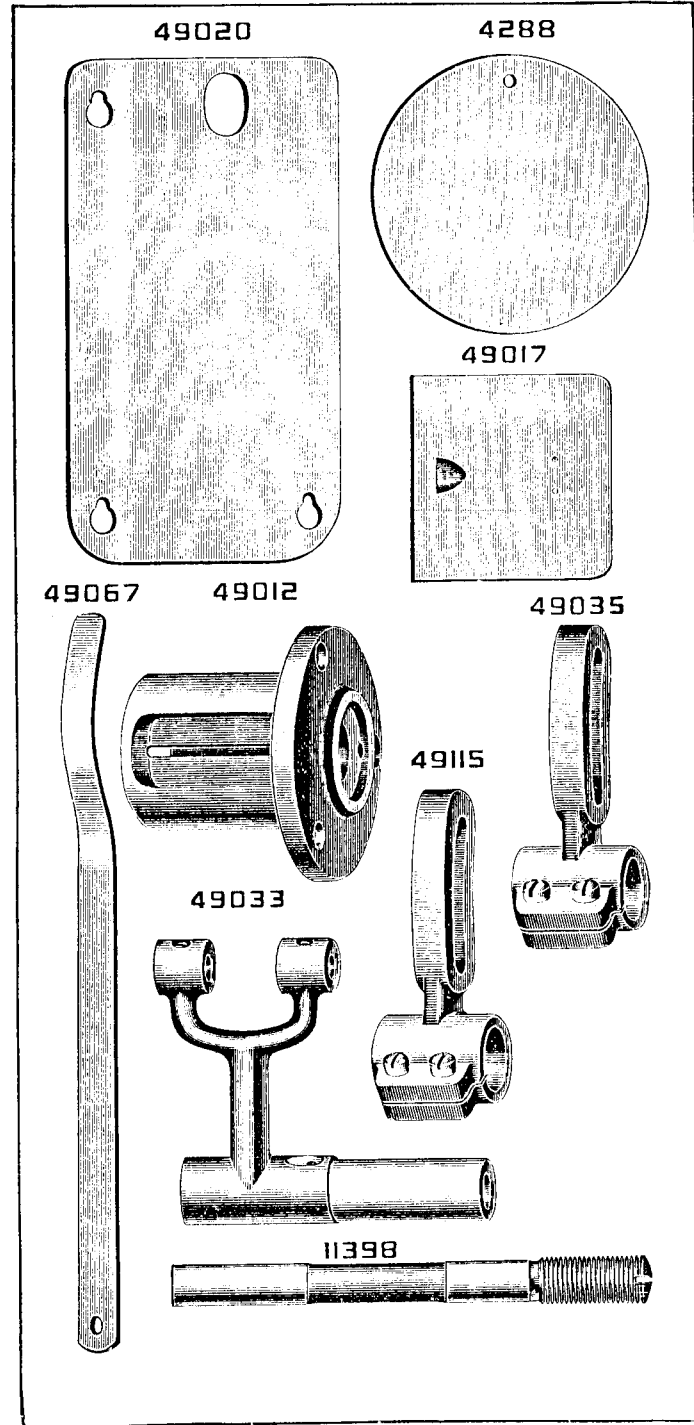

PLATE 6181—FULL SIZE

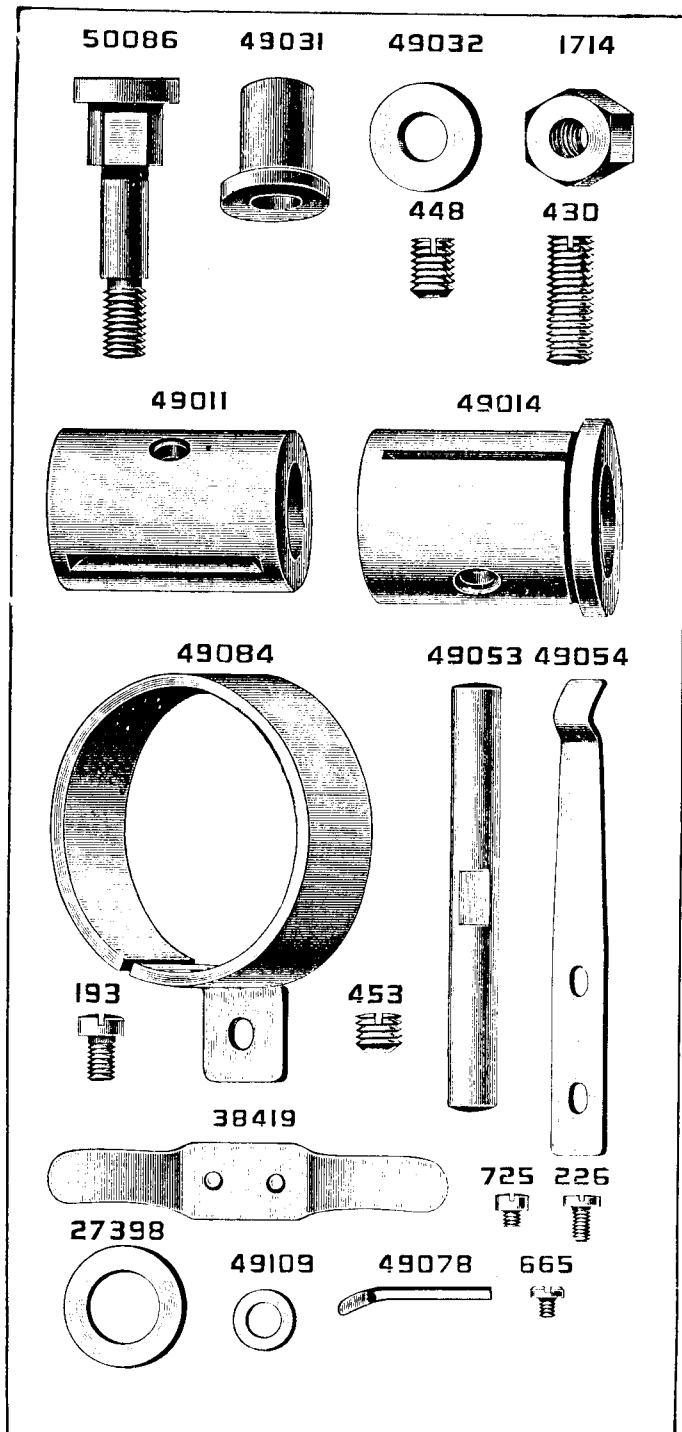

PLATE 6182—FULL SIZE

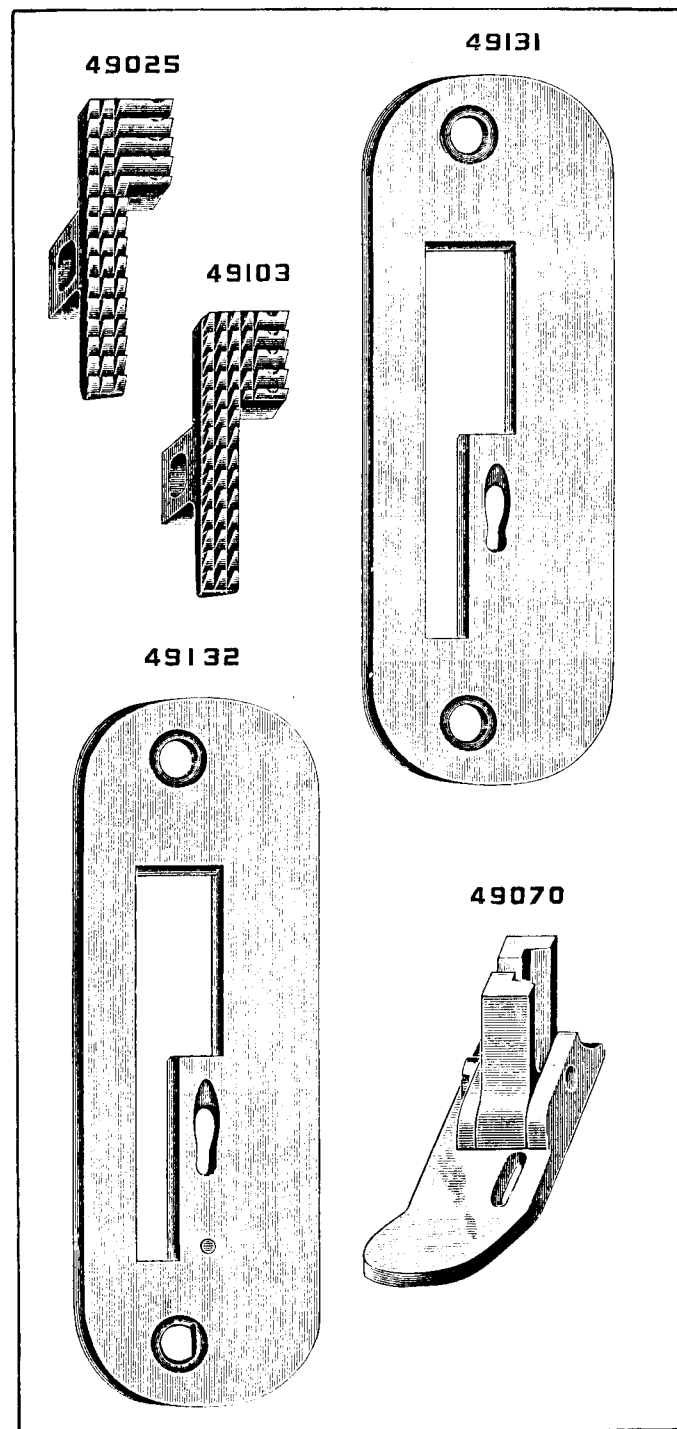

PLATE 6184—FULL SIZE

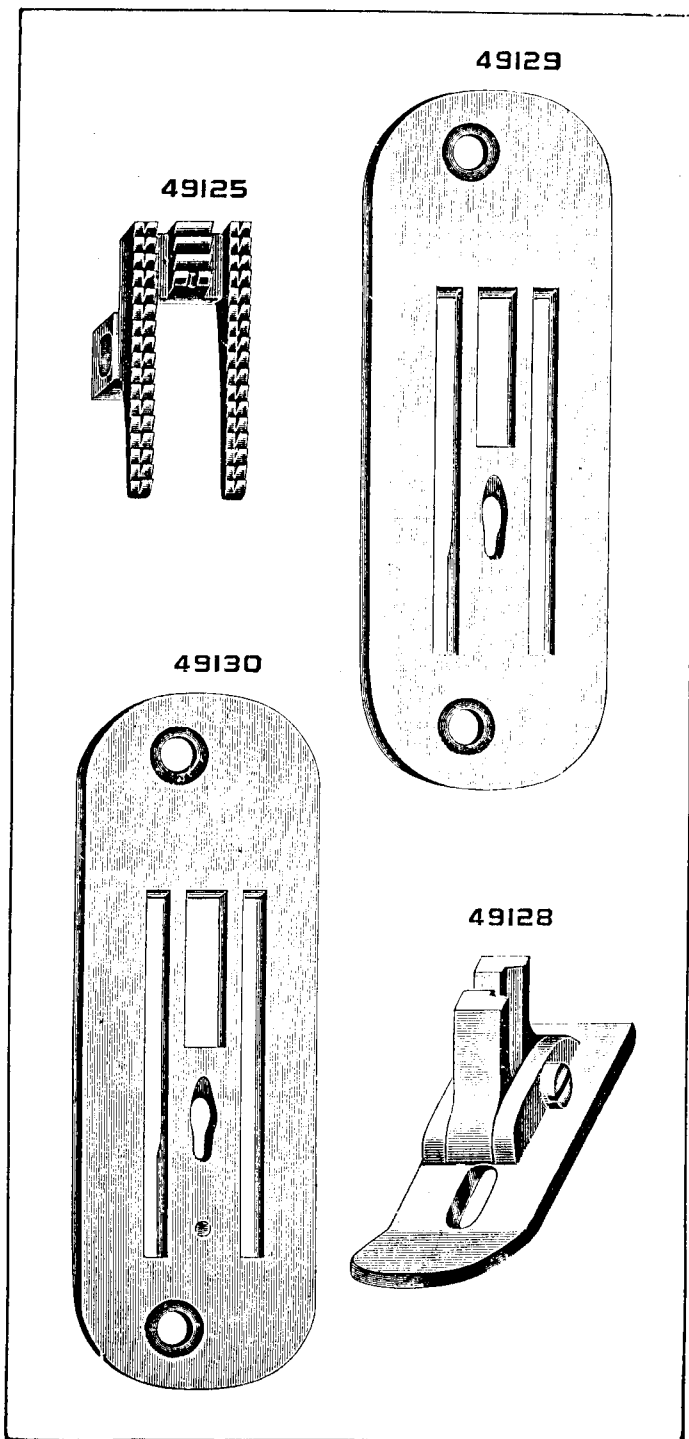

PLATE 6185—FULL SIZE

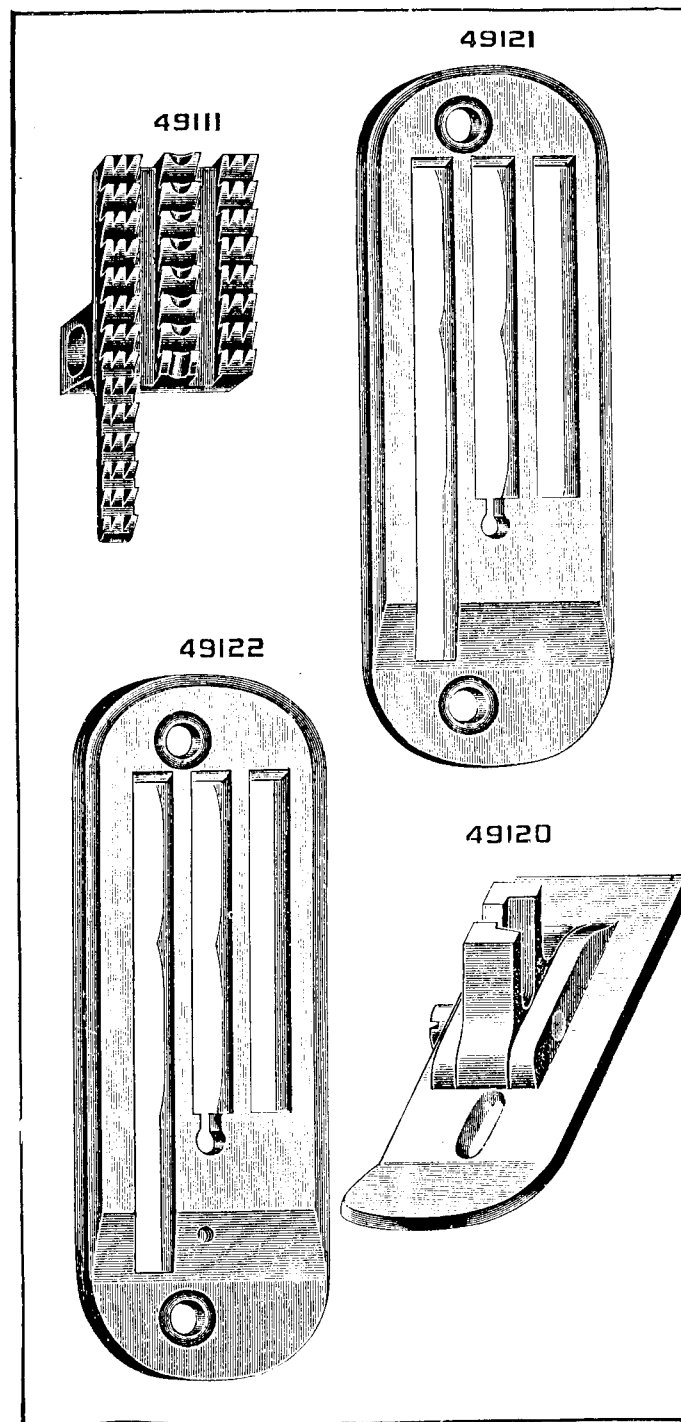
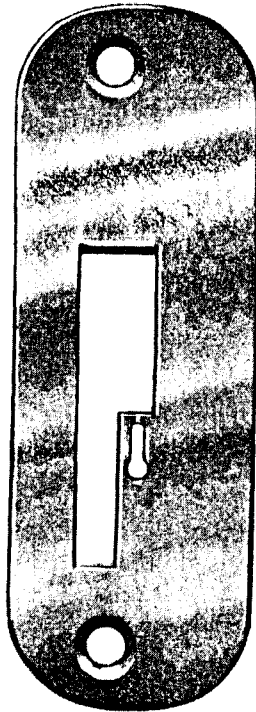

PLATE 6188—FULL SIZE

49154



49153



49155

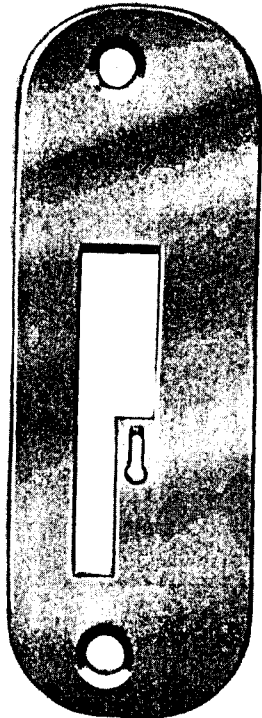

49082

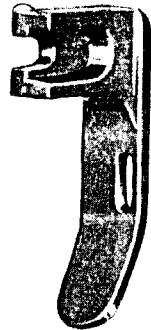
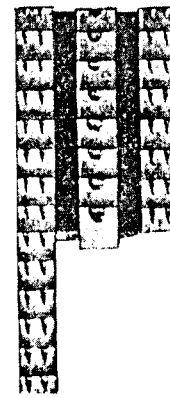

PLATE 6189—FULL SIZE

49228



49201



49229

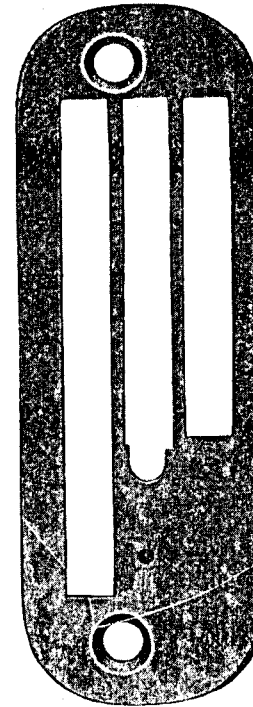

49219

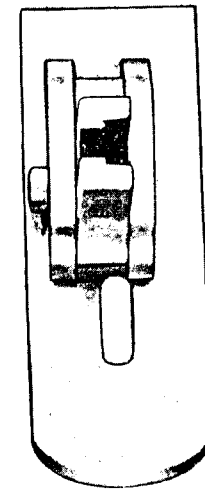

PLATE 6190—FULL SIZE

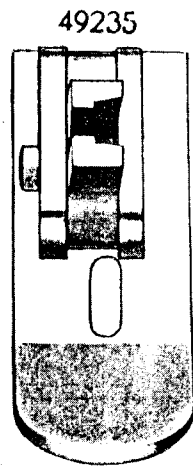
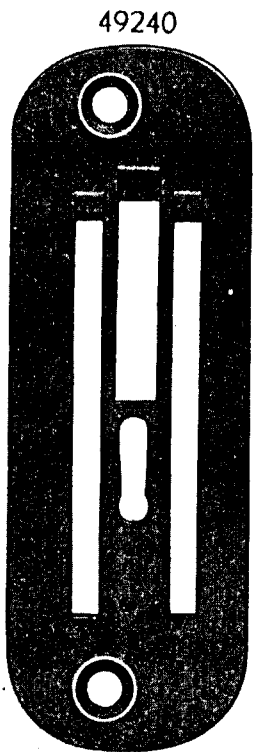
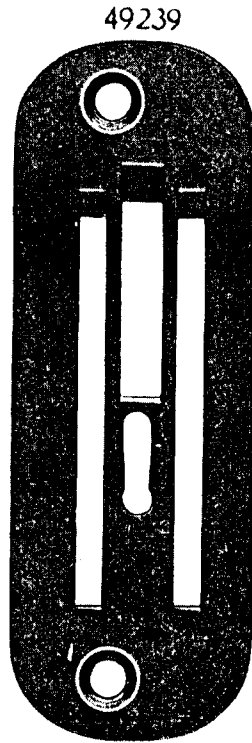
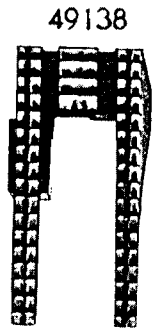

PLATE 6192—FULL SIZE

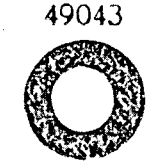
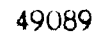
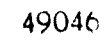
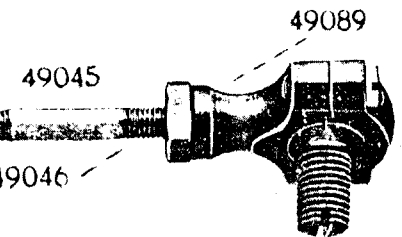
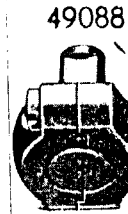
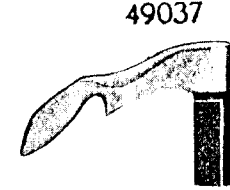
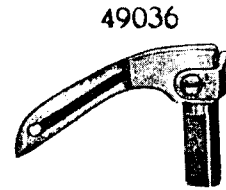

PLATE 6193—FULL SIZE

49047



453

49048

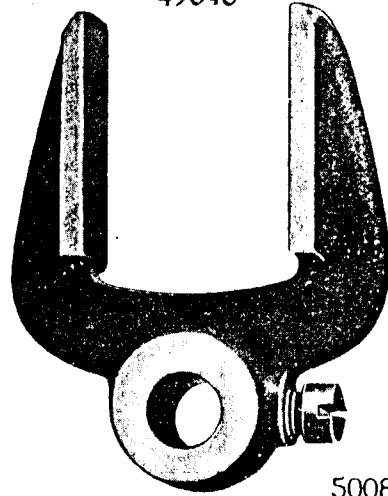

49049

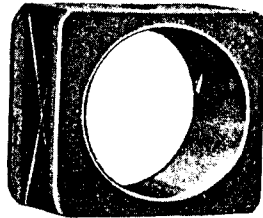

50083



1036



49142

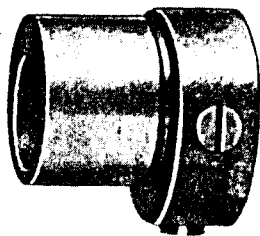

157



1324



49248

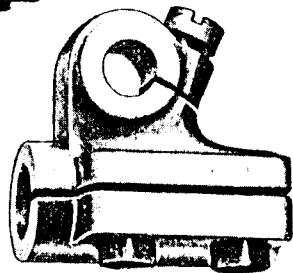

11411

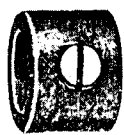
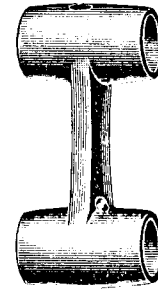

PLATE 6194—FULL SIZE

49055



49101



49057



1517

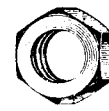

49056



49058



391

435



1133



2102

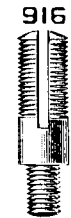
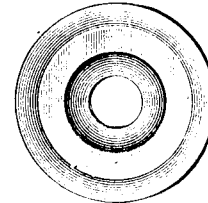

916

1560

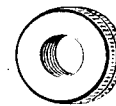

17547

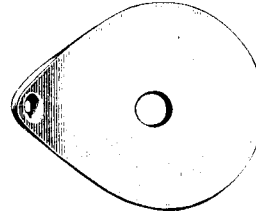

10148



13710



172



1629



49071

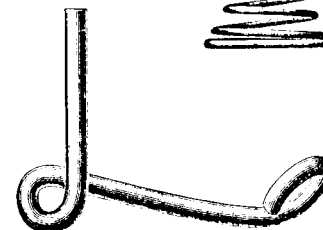

PLATE 6195—FULL SIZE

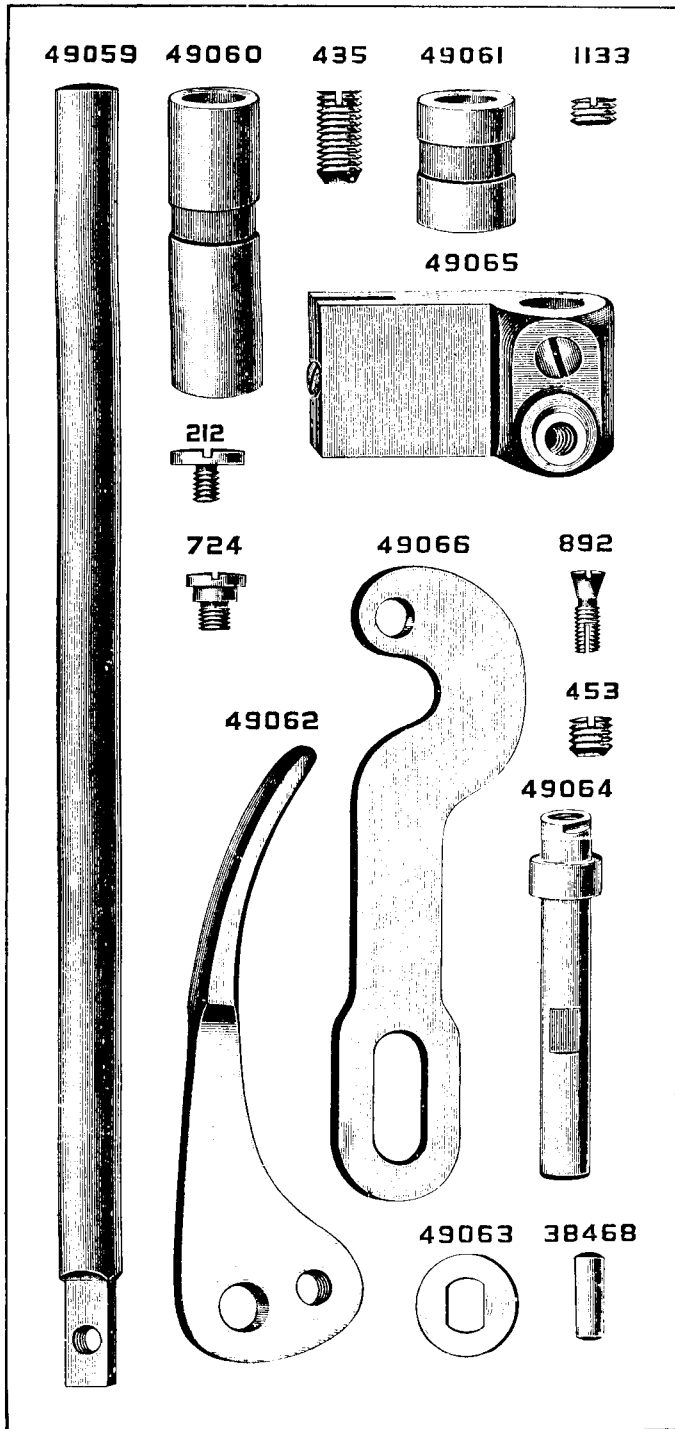

PLATE 6196—FULL SIZE

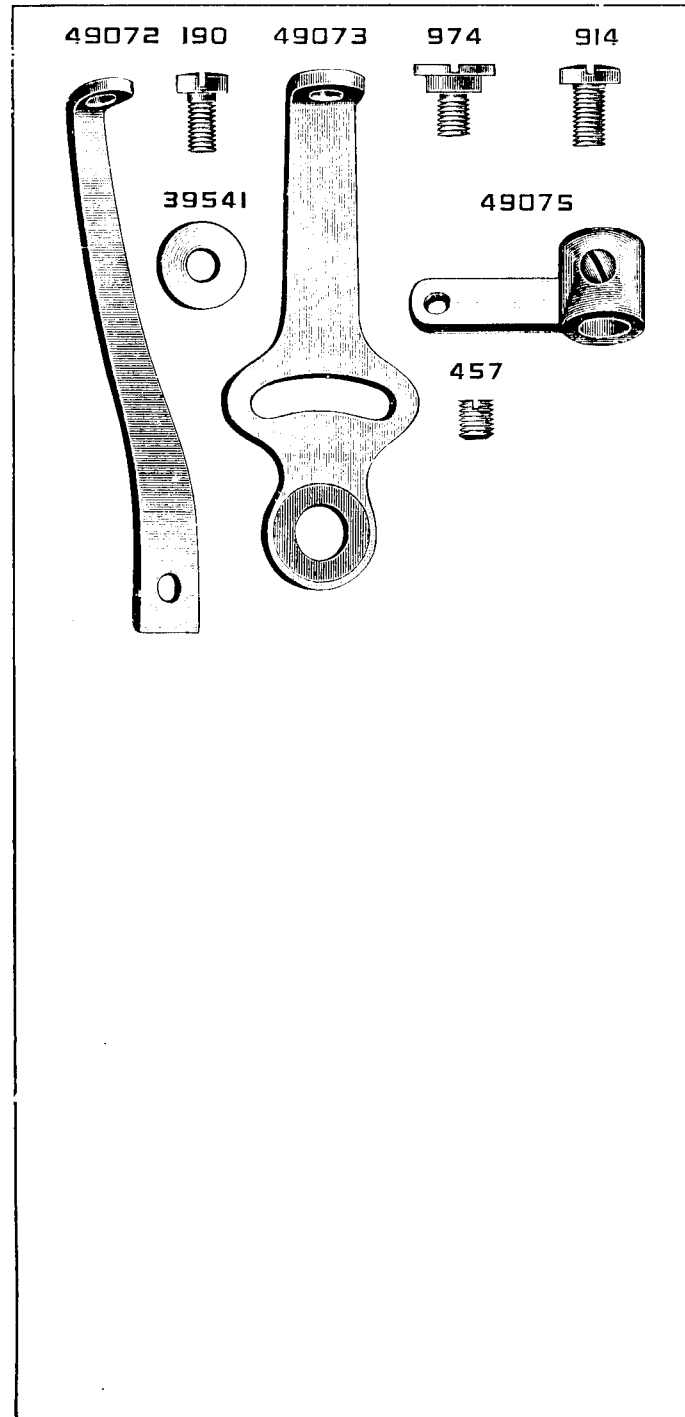

PLATE 6197—FULL SIZE

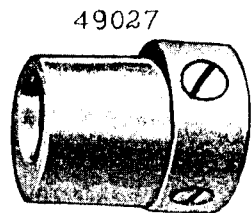
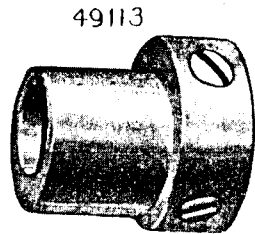
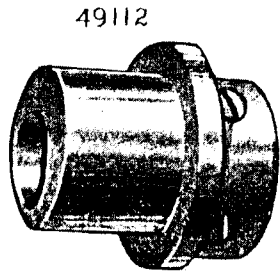
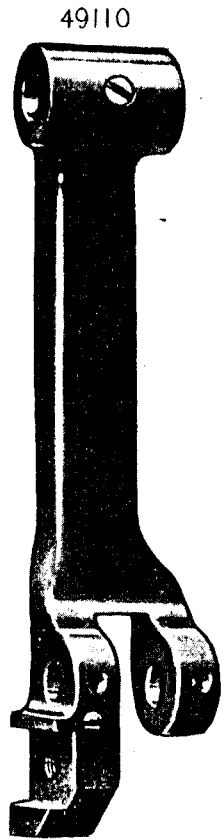

PLATE 6198—FULL SIZE

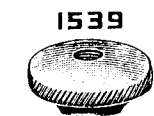
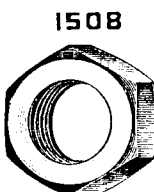
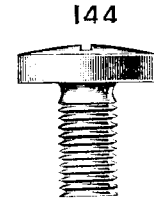
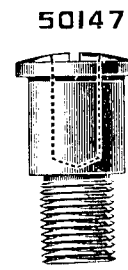

PLATE 6199—FULL SIZE

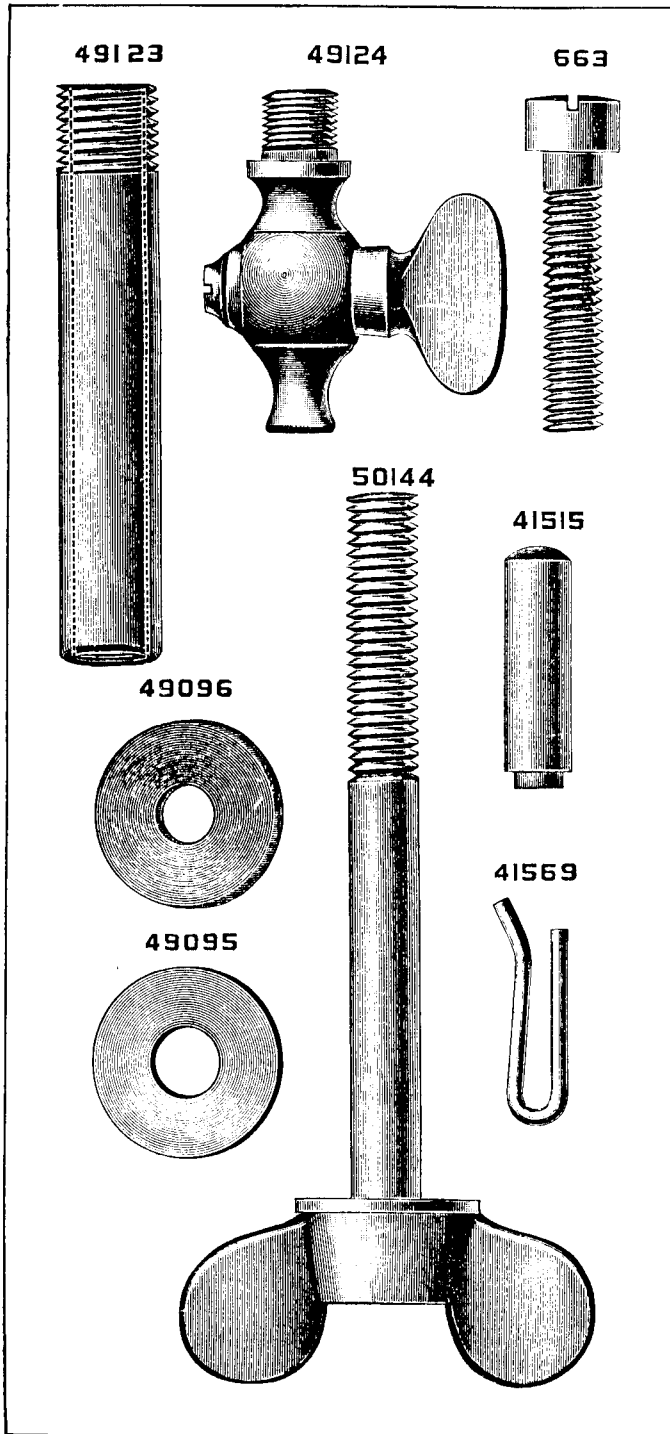

PLATE 6200—FULL SIZE

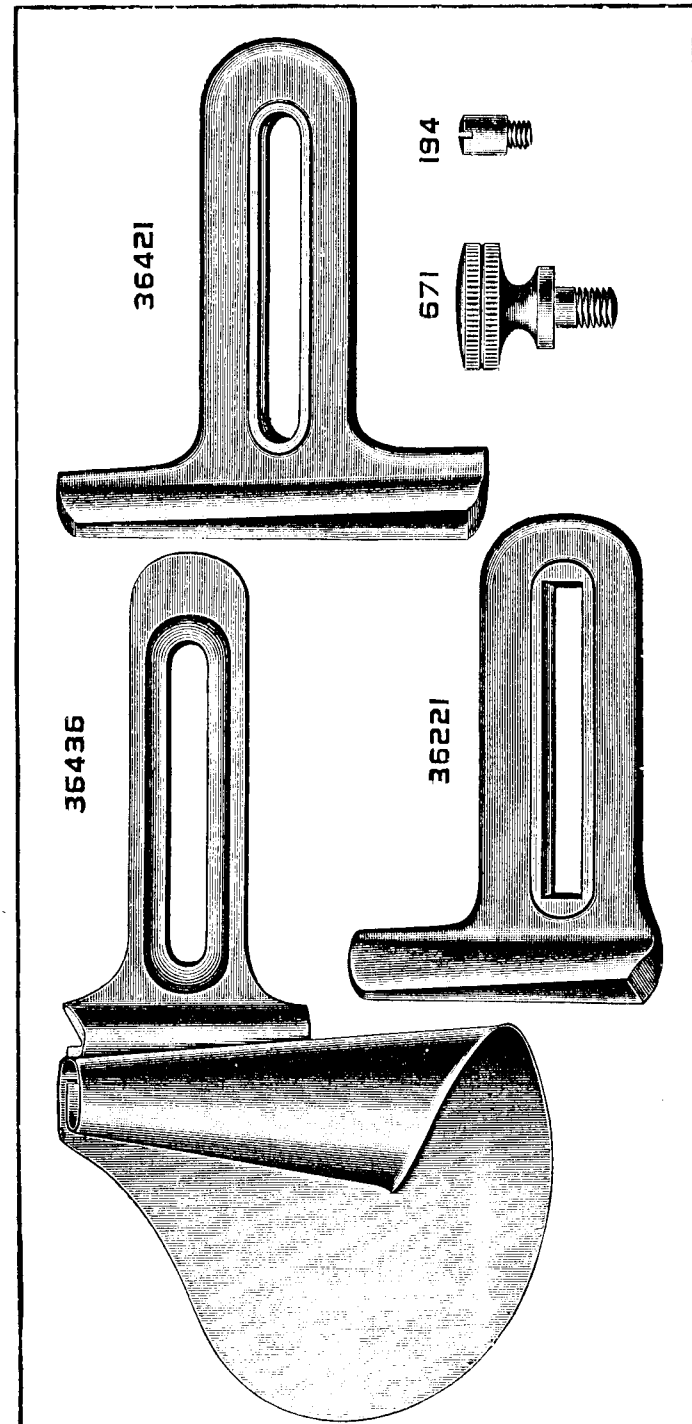

PLATE 6201—ONE-HALF SIZE

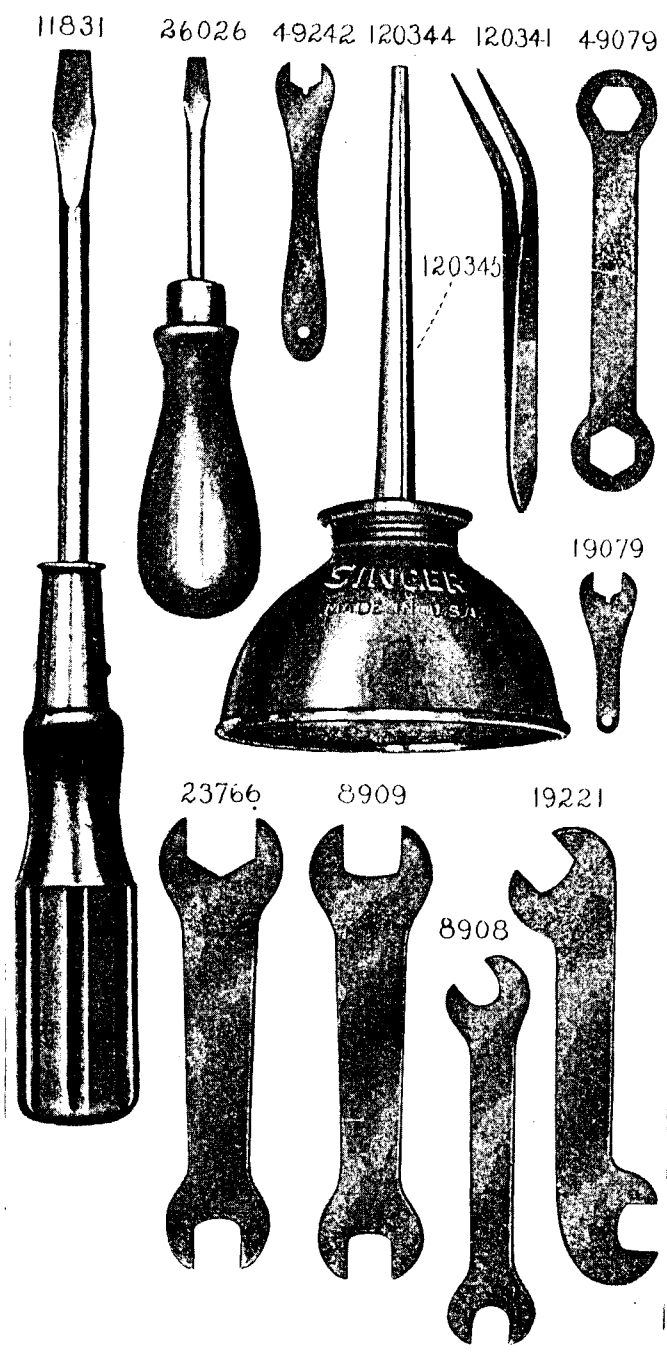

PLATE 6205—FULL SIZE

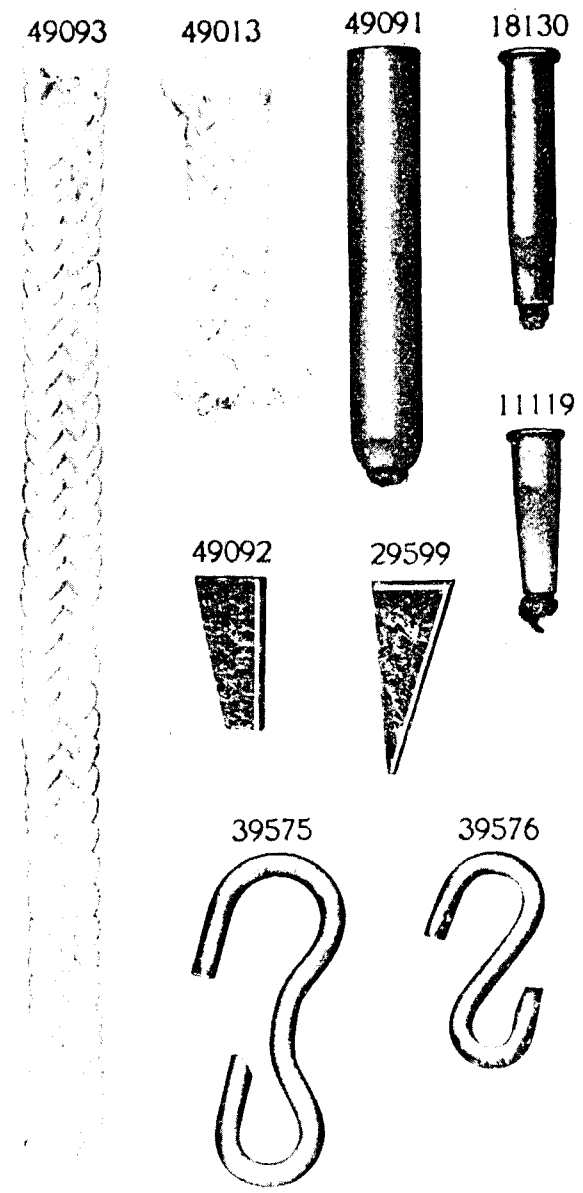

PLATE 6206—FULL SIZE

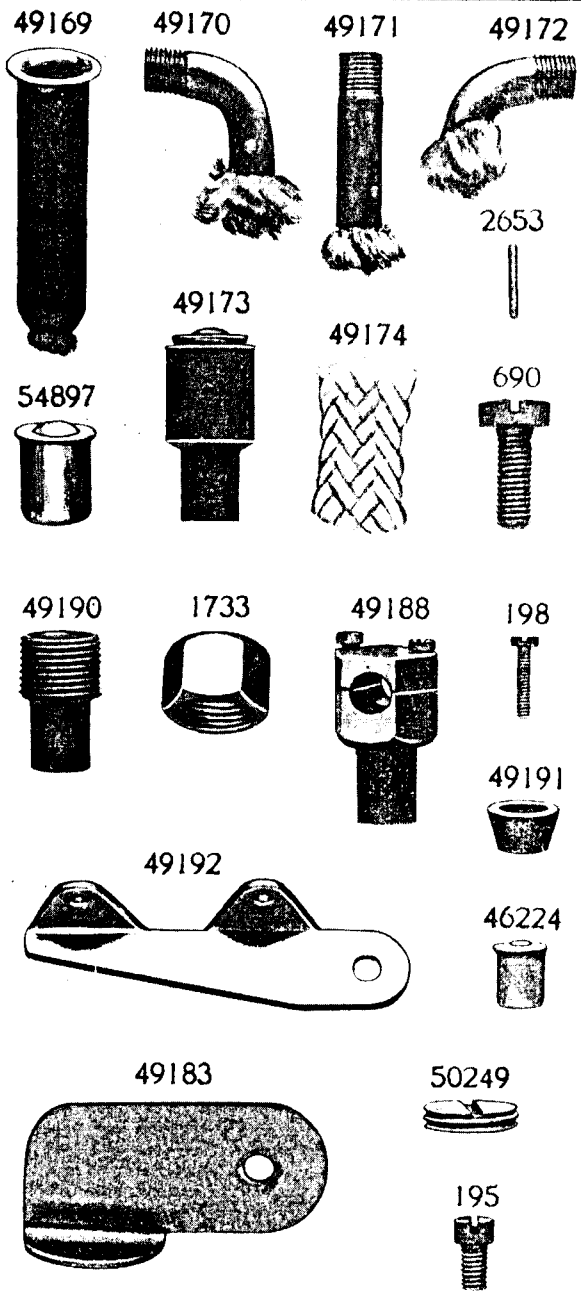

PLATE 6207—ONE-HALF SIZE

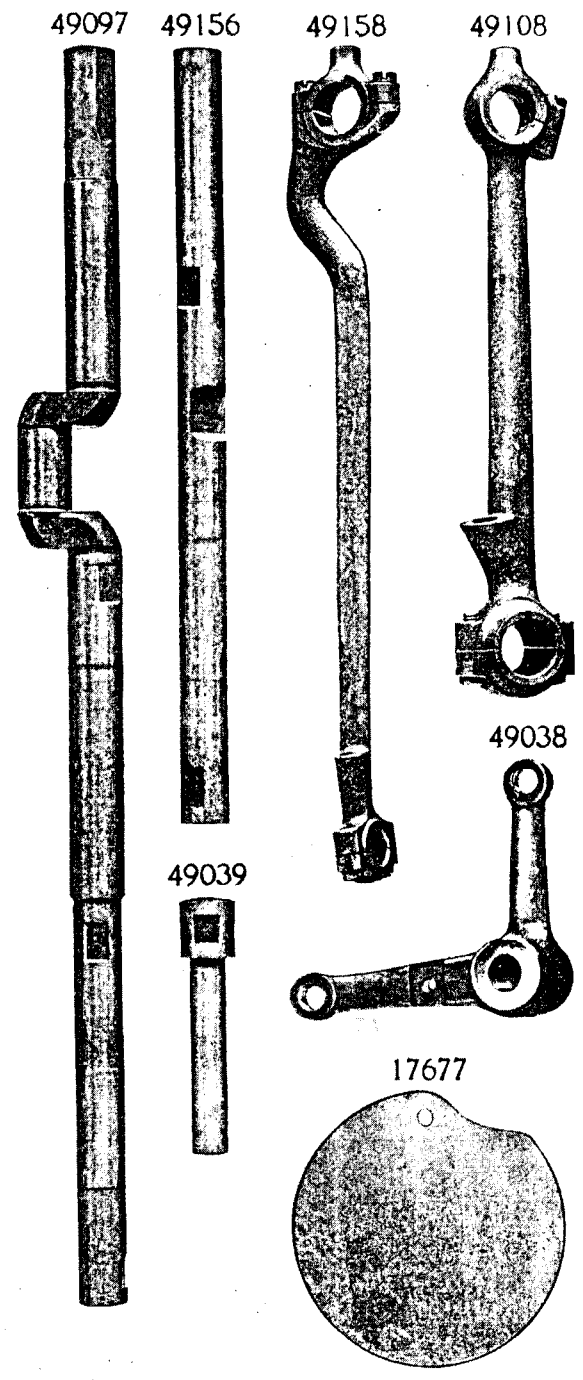

PLATE 6208—FULL SIZE

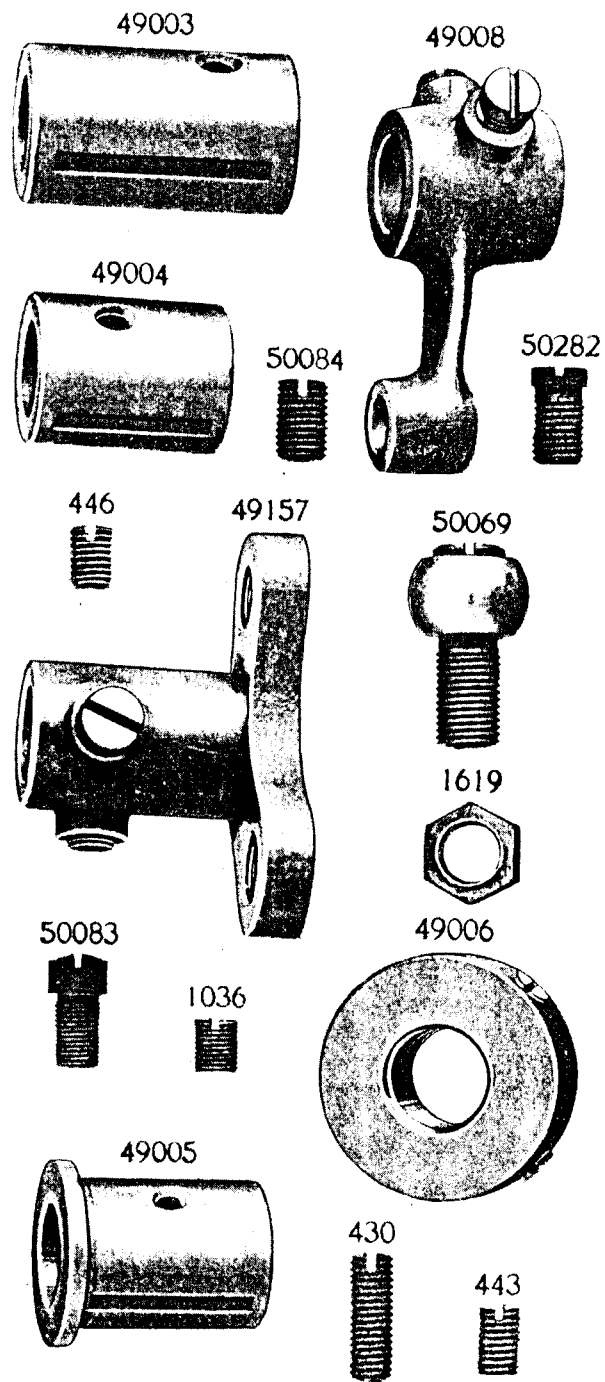

PLATE 6209—FULL SIZE

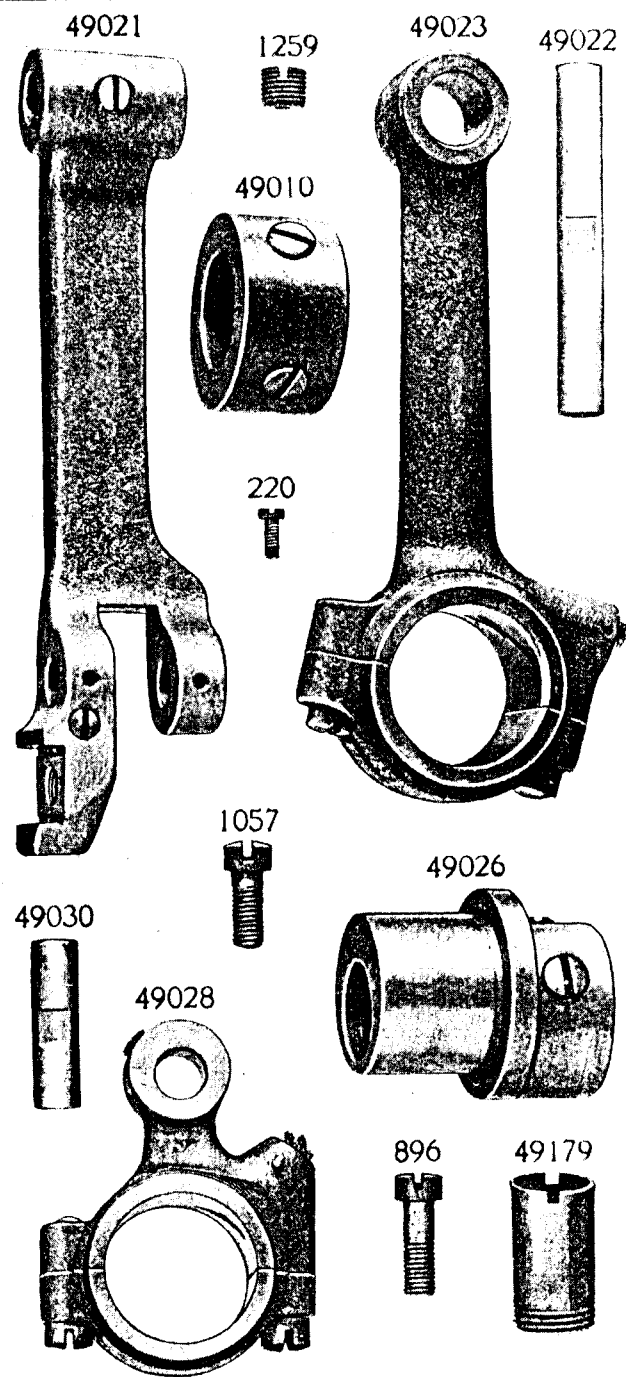
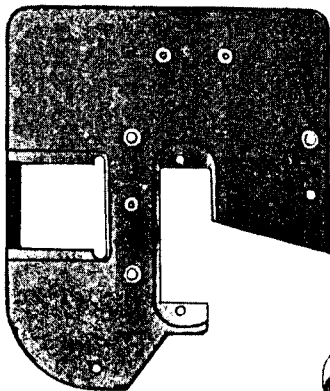

PLATE 6210—ONE-FOURTH SIZE

49175



23873



49116

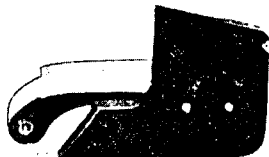

49195

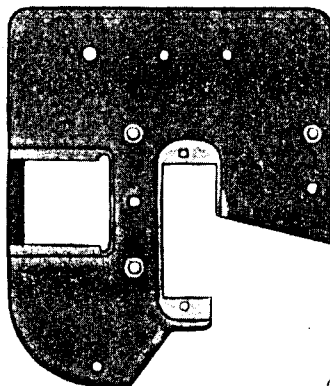

46220

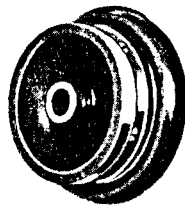

49212

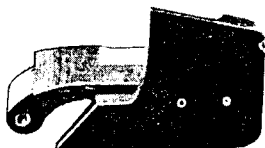

49143

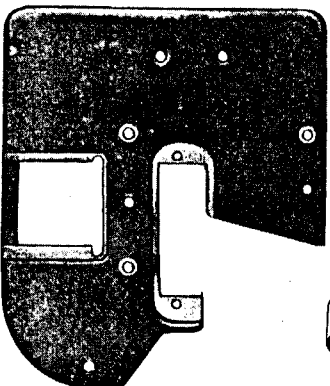

49145

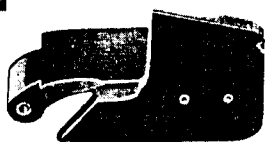

PLATE 6211—ONE-HALF SIZE

49105



49160



49177

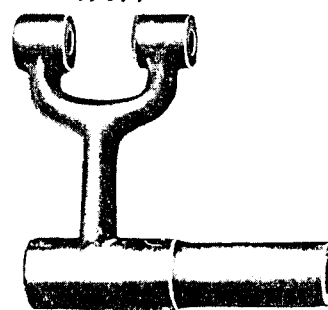

PLATE 6212—ONE-HALF SIZE

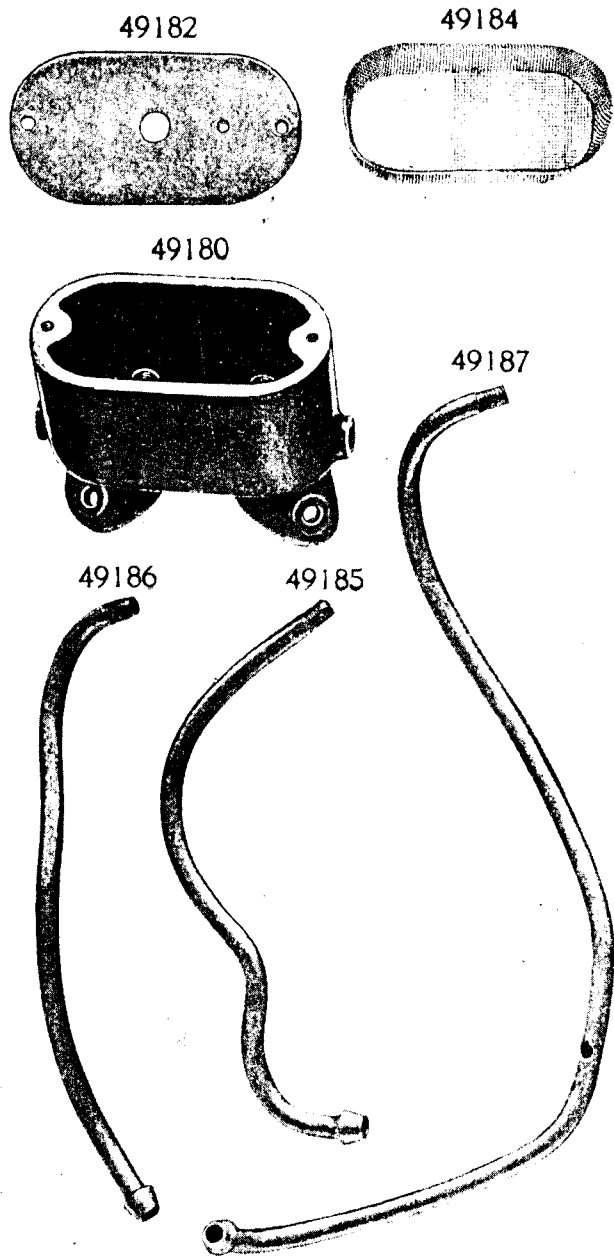

PLATE 6213—FULL SIZE

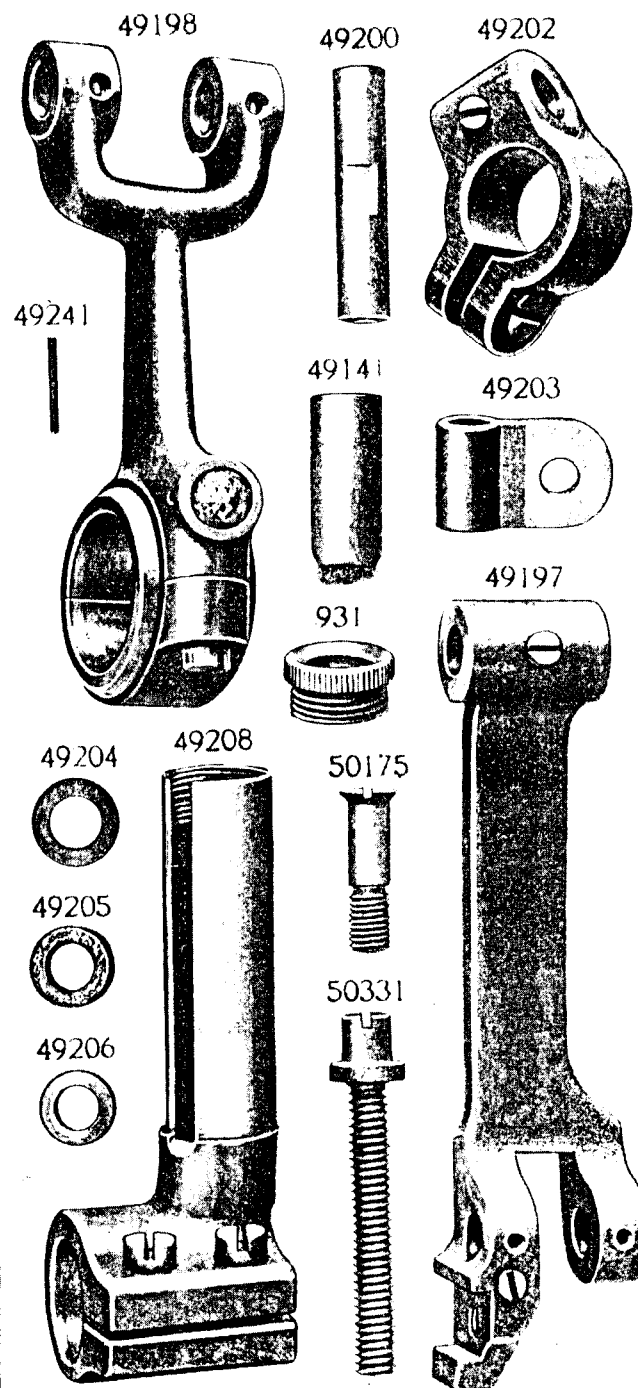
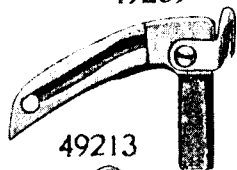

PLATE 6214—FULL SIZE

49214



49209



49211

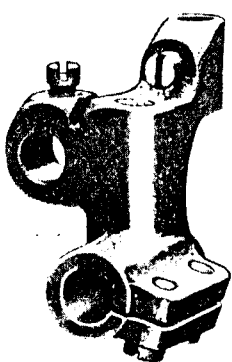

49213



49210



49216



49217



49220

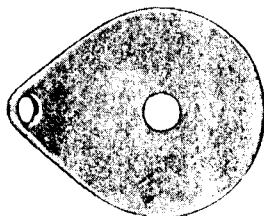

49221



49222



49223



207



49224



49215



49226



1740



49225

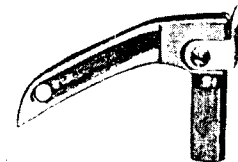

PLATE 6215—FULL SIZE

49245



49233



49236

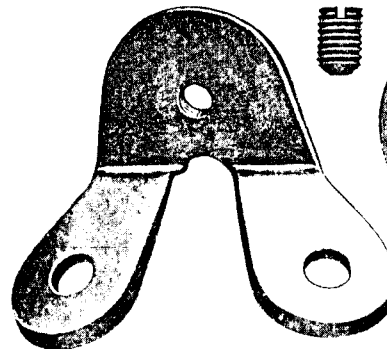

446



49232

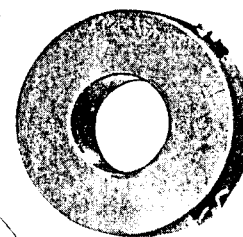

181



50133



54738

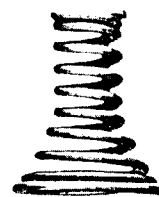

1560



2102

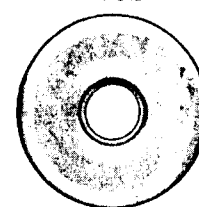

49237



32572

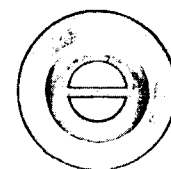

49238

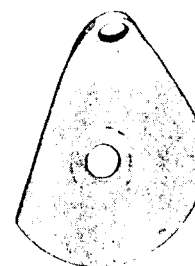

PLATE 6216—ONE-FOURTH SIZE

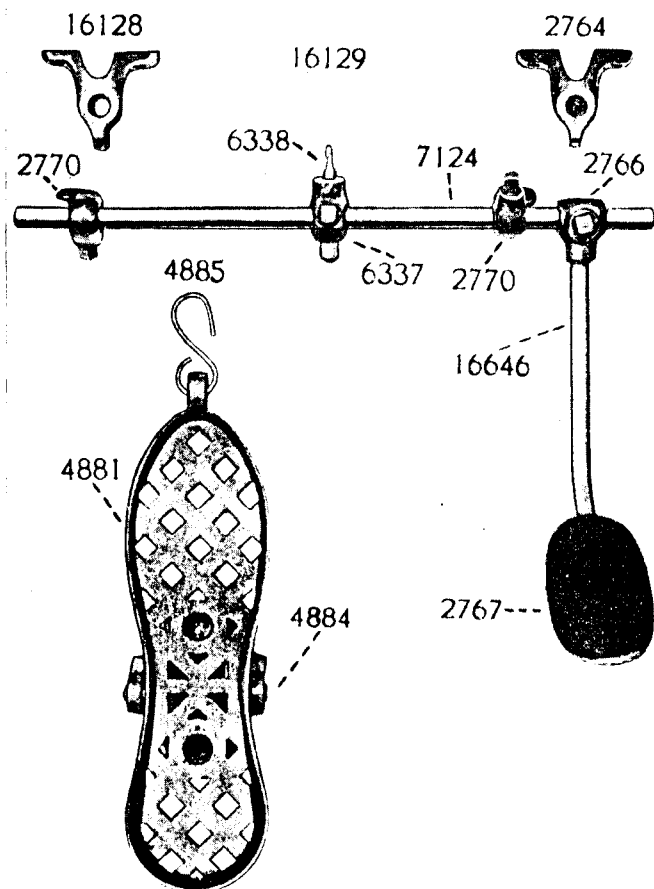
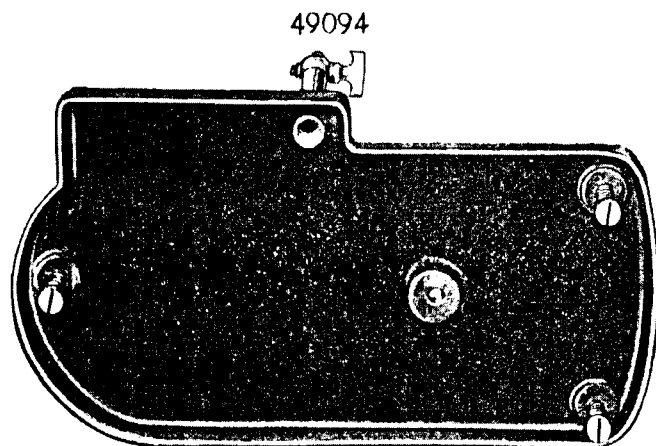

PLATE 6217—ONE-FOURTH SIZE

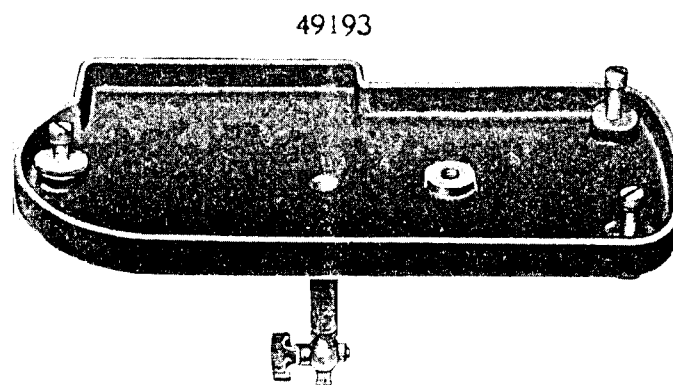

PLATE 6218—FULL SIZE

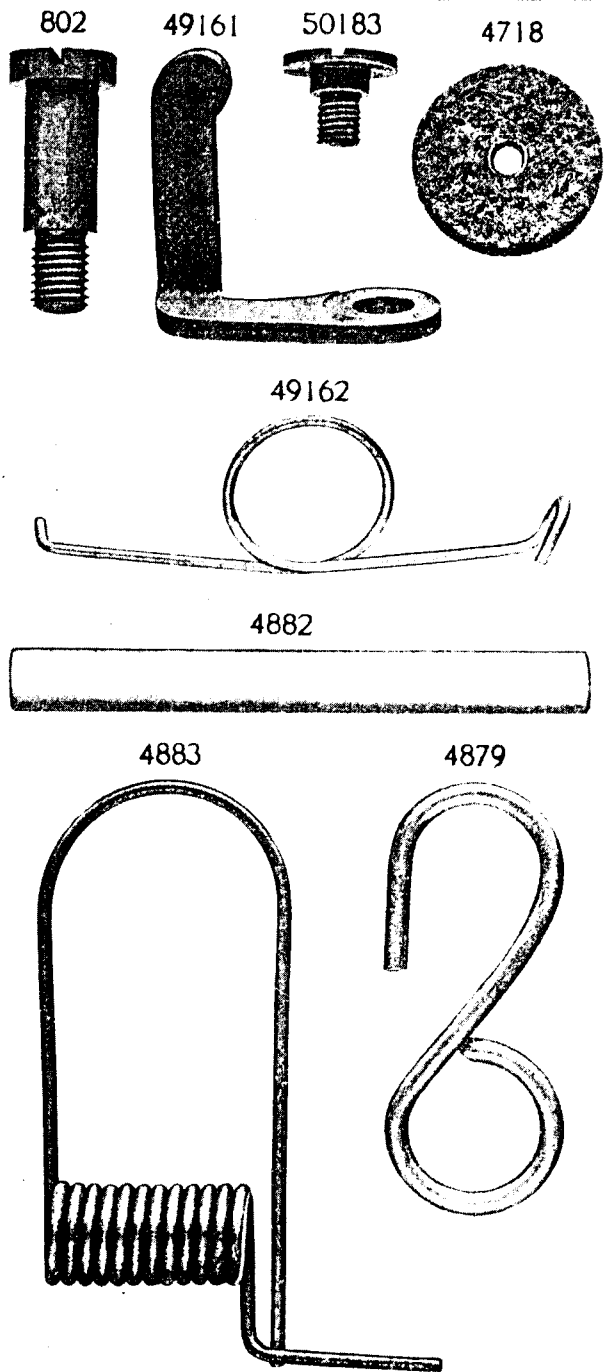

PLATE 6219—FULL SIZE

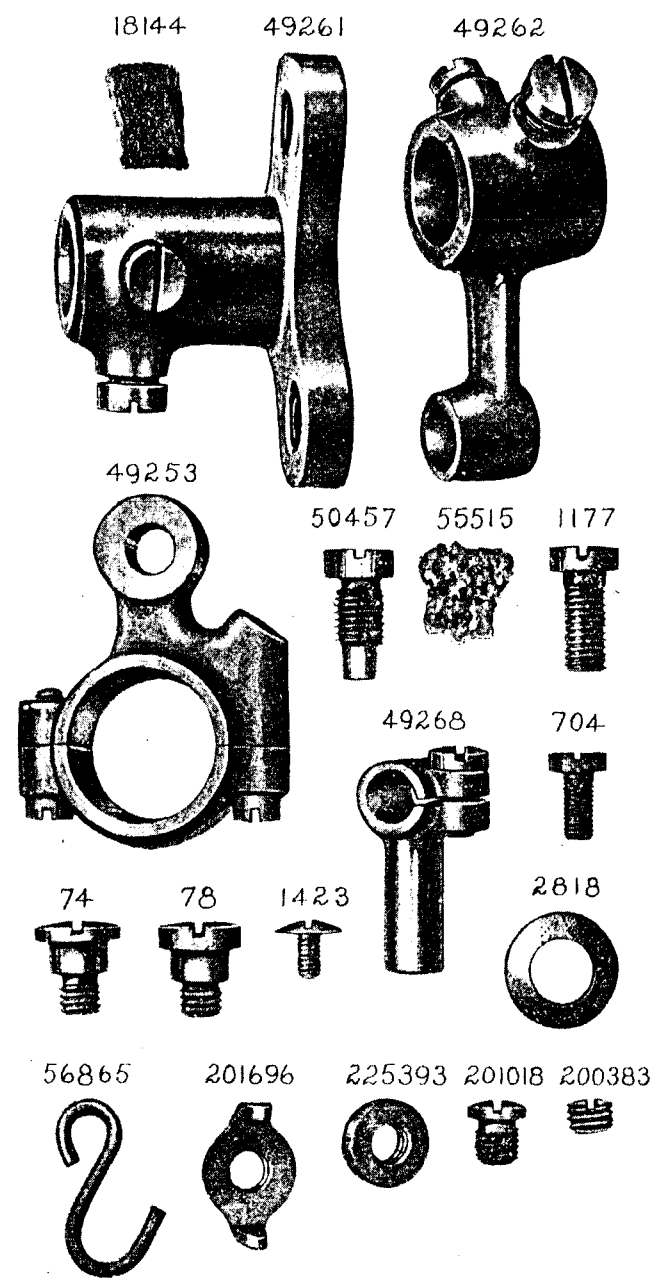
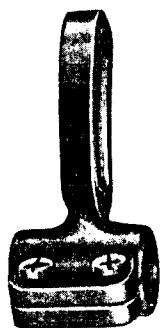

PLATE 6220—ONE-HALF SIZE

49265



49267



56864

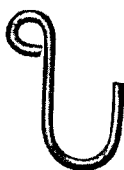

PLATE 6221—FULL SIZE

49149



49150



PLATE 6222—FULL SIZE

49151

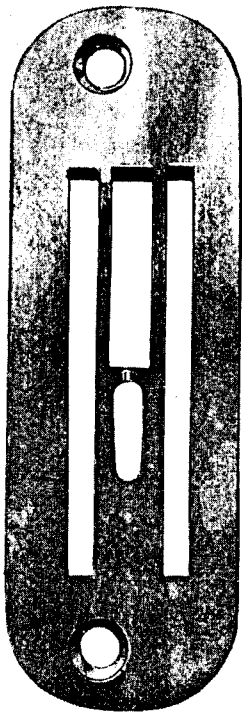

49152

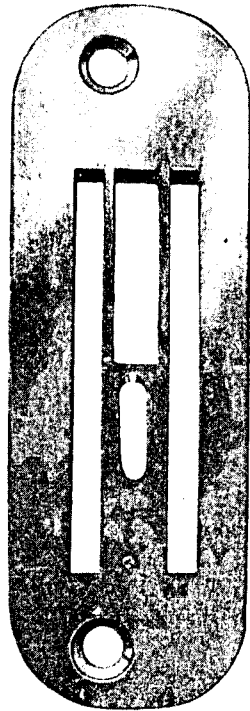
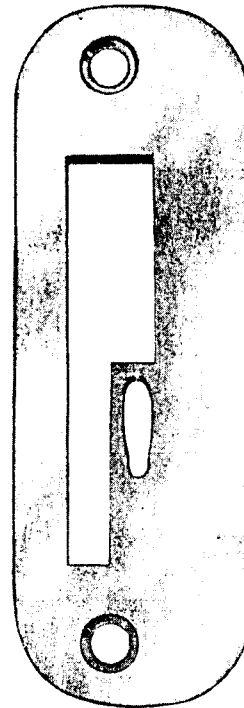
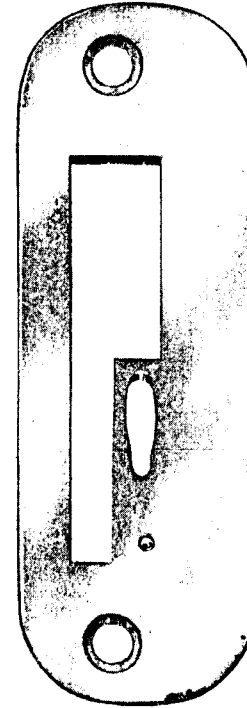

PLATE 6223—FULL SIZE

49147



49148



49146



PLATE 6224—FULL SIZE

49269

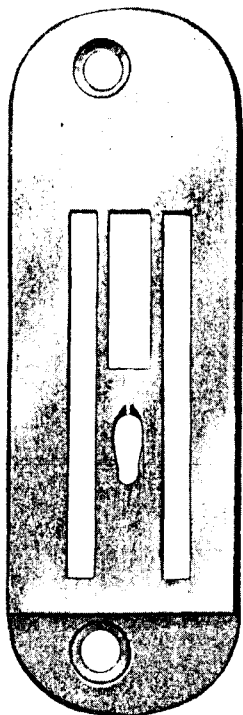

49270

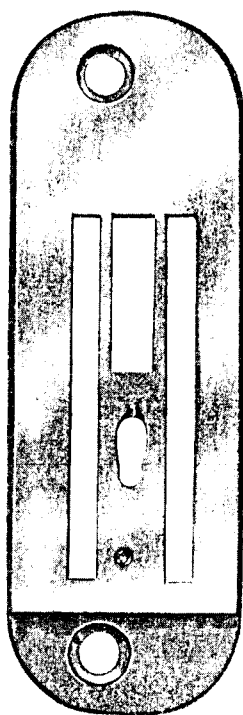

PLATE 7233—ONE-SIXTH SIZE

225396

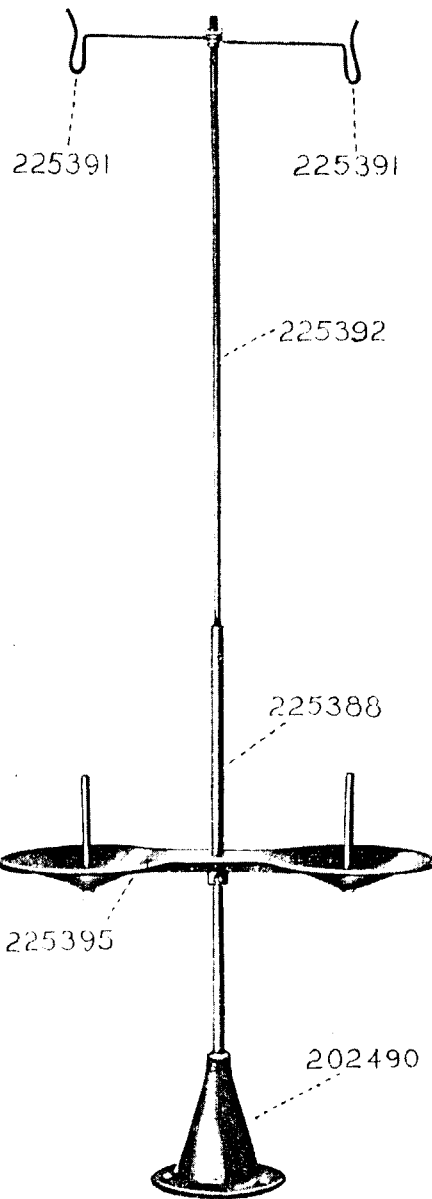

PLATE 7234—ONE-HALF SIZE

27739



225390

