

Form 8603, Revised
(1036)
Printed in U. S. A.

LIST
OF
PARTS



MACHINES
Nos. 96-3, 96-10, 96-12
and 96-16

THE SINGER MANUFACTURING COMPANY

INSTRUCTIONS FOR OILING

To ensure easy running and prevent unnecessary wear of the parts which are in movable contact, the machine requires oiling and when in continuous use, it should be oiled at least twice each day with Singer Manufacturing Sewing Machine Oil (Cloth and Leather).

Copyright, U. S. A., 1913, 1917, 1919, 1923 and 1936
by The Singer Manufacturing Co.
All Rights Reserved for all Countries

INDEX

	Page
Accessories.....	32
Bobbin Winders.....	34
Finger Guard.....	32
Foot Lifter Parts.....	36
Hemmers.....	33
Knee Lifter Parts.....	37
Machine Base.....	32
Machine No. 96-3.....	5
Machine No. 96-10.....	10
Machine No. 96-12.....	18
Machine No. 96-16.....	25
Obsolete Parts.....	38
Numerical List of Parts.....	41
Presser Feet.....	34
Thread Unwinder.....	38

INSTRUCTIONS FOR ORDERING

In ordering from this list, use **ONLY** the part **NUMBER** in the **FIRST** column.

The number stamped on a Sewing Machine Part is in every case the number of the single part only.

Every combination of parts sent out as such has its specific number, which, although not stamped on the parts, must be used when ordering the combination.

Each number always indicates the **SAME PART** in whatever list it appears, or for whatever machine.

The letters after some of the numbers indicate the style of finish only, as follows:

A-Hardened, Polished, Nickel Plated and Buffed

B-Polished, Nickel Plated and Buffed

C-Hardened Only

D-Polished Only

E-Soft, Not Polished

F-Hardened and Polished

F.J-Hardened, Polished and Nickel Plated

G-Bright Rumbled and Nickel Plated

H-Blued

J-Nickel Plated Only

K-Hardened and Nickel Plated

L-Brass Plated

M-Oxidized

N-Japanned, Dull

P-Japanned, Bright

R-Merlized

S-Cadmium Plating

T-Copper Plated

T.A-Hardened, Polished, Copper and Nickel Plated and Buffed

T.B-Copper and Nickel Plated and Polished

T.J-Copper and Nickel Plated Only

T.K-Hardened, Copper and Nickel Plated

T.M-Copper Plated and Oxidized

T.L-Copper and Brass Plated

U-Zinc Plated

V-Silver Plated

W-Polished and Nickel Plated

Y-Black Nickel Plated Only

Z-Chromium Plated

Z.B-Polished, Nickel Plated, Buffed and Chromium Plated

Z.J-Nickel and Chromium Plated

These letters **MUST BE USED** when they appear in the list; and **AFTER** the number as in the list.

In this series:

1 to 1500, 50001 to 51500 and 140001 to 142000 are Screw Numbers

1501 to 1800 and 51501 to 51800 are Nut Numbers

1901 to 2000 and 51901 to 52000 are Roller Numbers

2001 to 50000 and 52001 to 140000 and 142001 to

140000 are Sewing Machine Parts, 190001 and upward are numbers of Electrical Parts.

The figures in the second column refer only to the plates, illustrating the parts, and are **NOT TO BE USED** in ordering.

Parts marked with an asterisk (*) are furnished only when repairs are made at factory.

LIST OF PARTS COMPLETE

FOR

MACHINE No. 96-3

FOR CLOAKS, CLOTHING AND OTHER WORK IN
CLOTH. DROP FEED. SPEED 3000 R. P. M.

No.	Plate	Name
*52392	----	Arm.....
16532	5943	" Dowel Pin.....
24131	5900	" Oil Tube with 52045, for oiling 127152
12454	5900	" " " " 132590, for oiling 52024.
11119	5900	" " " " 52045, for oiling 52022.
24131	5900	" " " " 52045, for oiling 127156 for 52043.....
52045	5898	Arm Oil Tube Packing (cotton) for 11119 and 24131.....
132590	----	Arm Oil Tube Packing (wick) for 12454...
118E	5875	" Screw (back).....
854E	5942	" " (front).....
52302	7690	" Shaft.....
43921	5896	" " Flanged Bushing (back).....
448C	5875	" " " " " Set Screw
52195	----	" " " " " (front).....
52196	----	" " " " " 52195 with 52193 and 52198.....
52193	----	Arm Shaft Flanged Bushing (front) Oil Pad (inside).....
52198	----	Arm Shaft Flanged Bushing (front) Oil Pad (outside).....
435C	7691	Arm Shaft Flanged Bushing (front) Set Screw.....
144D	5875	Arm Shaft Screw.....
12480	5894	" Side Cap.....
219D	5875	" " " Screw.....
12193	5894	" " " Cover.....
50053D	7698	" " " Thumb Screw.....
12403	5900	" Spool Pin and Thread Eyelet.....
8879	5938	" " " Washer (cloth).....
52042	5896	" Top Cover.....
52043	5896	" " " 52042 with 12403 and 24131
180D	5875	" " " Screw.....
52005	5893	Balance Wheel (power) light rim, 2 3/16 in. pulley with two 448C.....
24297	5896	Balance Wheel Oil Cover.....
210D	5875	" " " " " Screw.....
448C	5875	" " " " " Set Screw.....
*52303	----	Bed.....

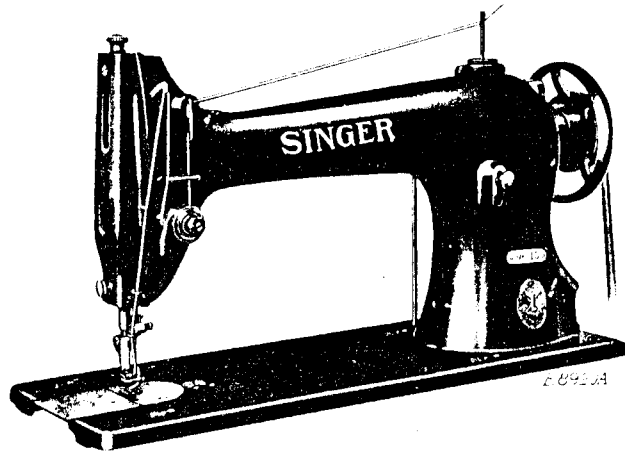
No.	Plate	Name
12431	----	Bed Slide.....
12432	5894	Bed Slide complete,Nos.4307,12431 and two 725J.....
4307	5894	Bed Slide Spring.....
725J	5875	" " " Screw.....
52051	----	Face Plate.....
52052	5894	Face Plate complete,Nos.52051,52053, 52170 and two 226J.....
190J	5875	Face Plate Screw.....
52053	5900	" " Thread Guard (lower).....
226J	5900	" " " " " Screw...
52170	----	" " " " (upper).....
226J	5900	" " " " " Screw...
50190D	7691	" " Thumb Screw.....
52452	7694	Feed Bar.....
313C	5875	" " Screw Center.....
1519J	5942	" " " " Nut.....
3033	7695	" Connecting Link.....
375C	7695	" " " Hinge Screw.....
1518J	7695	" " " " " Nut....
44136	5805	" Dog.....
50117E	5875	" " Screw.....
20283	5947	" and Feed Lifting Eccentric with 446C.....
446C	5942	Feed and Feed Lifting Eccentric Set Screw.....
127152	----	Feed and Feed Lifting Eccentric Sleeve..
20284	5947	" Forked Connection.....
375C	7695	" " " Hinge Screw.....
1518J	7695	" " " " " Nut..
44125	7690	" Lifting Rock Shaft.....
44126	----	Feed Lifting Rock Shaft complete,Nos. 12376 and 44125.....
127156	----	Feed Lifting Rock Shaft Connecting Rod with two 966E.....
966E	7691	Feed Lifting Rock Shaft Connecting Rod Cap Screw.....
375C	7695	Feed Lifting Rock Shaft Connecting Rod Hinge Screw.....
1518J	7695	Feed Lifting Rock Shaft Connecting Rod Hinge Screw Nut.....
*52271	----	Feed Lifting Rock Shaft Crank.....
12376	7692	" " " " " 52271 with 157J and 1813.....
157J	7692	Feed Lifting Rock Shaft Crank Clamping Screw.....
1813	7692	Feed Lifting Rock Shaft Crank Roller and Stud.....
307C	5875	Feed Lifting Rock Shaft Screw Center....
1513J	5942	" " " " " Nut
3039	7698	" Regulator.....
1128E	7695	" " Hinge Screw.....

No.	Plate	Name
818D	5897	Feed Regulator Thumb Screw.....
52359	5948	" " " " Stop.....
12379	7690	" Rock Shaft.....
20333	----	Feed Rock Shaft complete,Nos.12379 and 29633.....
29633	7692	Feed Rock Shaft Crank with 157J.....
157J	7692	" " " " Clamping Screw....
307C	5875	" " " Screw Center.....
1513J	5942	" " " " " Nut.....
25878	6449	Guide.....
50190D	7691	" Thumb Screw.....
52304	5948	Needle Bar (hollow).....
52305	5948	" " Bushing (lower) with 29532...
1133E	5948	" " " " Set Screw....
52014	5948	" " " (upper).....
1133E	5948	" " " " Set Screw....
24040	5948	" " Connecting Link with 794E....
794E	5948	" " " " Adjusting Screw.....
775E	5948	Needle Bar Connecting Link Cap Screw....
24041	5948	" " " Stud with 207E....
207E	5948	" " " " Clamping Screw.....
24052	7694	Needle Bar Crank with 1036C,1037C and 1065C.....
1065C	5875	Needle Bar Crank Position Screw.....
29532	5948	" " Oil Cup.....
52306	5948	" " Thread Guard.....
229J	5948	" " " " Screw.....
52307	5948	" Clamp with 51460F.....
51460F	----	" " Screw.....
12391	5896	Presser Bar (hollow).....
52338	5936	" " Guide Bracket with 223C with 453C.....
453C	5936	Presser Bar Guide Bracket Set Screw....
52016	5936	" " Lifter.....
689C	5936	" " " Screw.....
1520J	5936	" " " Nut.....
12327	5936	" " Lifting and Releasing Lever Bracket.....
11167	5896	Presser Bar Spring.....
11170	5936	" " " Washer.....
29534	7698	" Foot.....
190J	5875	" " Screw.....
688J	5875	Pressure Regulating Thumb Screw.....
52121	----	Rotating Hook with three 1253C.....
52123	----	" " 52121 with 52090 and four 1053E.....
127060	----	Rotating Hook 52123 with 40274,127100 and three 1367E.....
52478	----	Rotating Hook 127060 with 52473.....
52089	5898	" " 52123 with 40274 and three 1367E (For Agents Only).....

No.	Plate	Name
40258	5935	Rotating Hook Belt.....
52037	5935	" " " Guard.....
181D	5875	" " " Screw.....
52048	5888	" " " Pulley (lower) steel, with two 1147C and sixteen 52049...
1147C	7698	Rotating Hook Belt Pulley (lower) Set Screw.....
52049	5888	Rotating Hook Belt Pulley (lower) Stud..
52050	5888	" " " " (upper) with 1362C and thirty 40263.....
1362C	5942	Rotating Hook Belt Pulley (upper) Set Screw.....
40263	7698	Rotating Hook Belt Pulley (upper) Stud..
40264	5869	" " Bobbin.....
52472	----	" " " Case.....
52481	----	" " " " 52472 with 591F, 1380E and 40394.....
40392	5869	Rotating Hook Bobbin Case Latch.....
125320	----	" " " " " Lever...
2974	5869	" " " " " " Fulcrum Pin.....
2975	5869	Rotating Hook Bobbin Case Latch Spring..
592E	5869	" " " " " Stop Screw.....
40393	----	Rotating Hook Bobbin Case Hinge, Nos. 2974, 40392 and 125320.....
591F	5869	Rotating Hook Bobbin Case Tension Regu- lating Screw.....
40394	5869	Rotating Hook Bobbin Case Tension Spring
1380E	5869	" " " " " " Screw.....
52473	----	Rotating Hook Bobbin Case complete, Nos. 592E, 2975, 40393 and 52481.....
127099	----	Rotating Hook Bobbin Case 52473 with 127100 (For Agents Only).....
127100	----	Rotating Hook Bobbin Case Holder with 52475 and two 52476.....
52018	5869	Rotating Hook Bobbin Case Holder Posi- tion Bracket.....
704J	5869	Rotating Hook Bobbin Case Holder Posi- tion Bracket Screw.....
*52475	----	Rotating Hook Bobbin Case Locating Plate
*52476	----	" " " " " Rivet.....
40274	5869	Rotating Hook Section.....
1367E	5869	" " " Screw.....
1253C	5869	" " Set Screw.....
52308	5935	" " Shaft.....
52044	7698	" " " Bushing (back).....
52045	5898	" " " " " Packing (cotton).....
447C	5898	Rotating Hook Shaft Bushing (back) Set Screw.....

No.	Plate	Name
52039	7698	Rotating Hook Shaft Bushing (front).....
52045	5898	" " " " " Pack- ing (cotton).....
50145E	7698	Rotating Hook Shaft Bushing (front) Position Screw.....
52090	5898	Rotating Hook Thread Guard.....
1053E	5869	" " " " " Screw.....
52337	5938	Slack Thread Regulator.....
223C	5938	" " " " " Set Screw.....
2102	7692	Tension Disc.....
1580C	7692	" Regulating Thumb Nut.....
32572	7692	" Releasing Disc.....
43944	5936	" " " Lever.....
12398	5936	" " " Hinge Pin.....
12329	5938	" " " Spring.....
32574	7692	" " " Pin.....
2103	7692	" Spring.....
50304C	7692	" Stud.....
52098	----	" " 50304C with 1580C.....
50305C	7692	" " Set Screw.....
52397	----	Tension complete, Nos. 2103, 32572, 32574, 52083, 52098, 52394 and two 2102.....
52027	7692	Thread Guard (side of arm).....
52454	7698	" Retainer.....
460C	7691	" " Set Screw.....
52021	5948	" Take-up Crank.....
1037C	5948	" " " Position Screw.....
1038C	5948	" " " Set Screw.....
52022	5948	" " " Lever with 52130.....
52023	5948	" " " Hinge Pin.....
52024	5948	" " " Link.....
11204	5948	" " " " Hinge Pin.....
435C	7691	" " " " " " Set Screw.....
52130	----	Thread Take-up Lever Thread Eyelet Bush- ing.....
52025	----	Thread Take-up Lever complete, Nos. 52022 to 52024.....
52394	5948	Thread Take-up Spring.....
52083	7692	" " " Regulator with 50305C.....
448C	5875	Thread Take-up Spring Regulator Set Screw.....
44137	5805	Throat Plate, large needle hole, for 44136.....
691F	5875	Throat Plate Screw.....
44212	----	Drip Pan with four 1 in. wire nails.....
*15404	----	Trade Mark.....
15405	----	" " Rivet.....

LIST OF PARTS COMPLETE
FOR



MACHINE No. 96-10

FOR CLOAKS, CLOTHING AND OTHER WORK IN
CLOTH. DROP FEED. SPEED 3200 R. P. M.

No.	Plate	Name
*52381	----	Arm with two 56015.....
16532	5943	" Dowel Pin.....
24131	5900	" Oil Tube with 52045, for oiling 127152.....
52084	5900	Arm Oil Tube with 52045, for oiling 24040
11119	5900	" " " " 52045, for oiling 52022
24131	5900	" " " " 52045, for oiling 127156, for 52043.....
52045	5898	Arm Oil Tube Packing (cotton) for 11119 and 24131.....
116E	5875	Arm Screw (back).....
854E	5942	" " (front).....
52382	5946	" Shaft (horizontal).....
52191	----	" " " Flanged Bushing (back).....
52192	----	Arm Shaft (horizontal) Flanged Bushing (back) 52191 with 52193 and 52194..
52193	----	Arm Shaft (horizontal) Flanged Bushing (back) Oil Pad (inside) braided cotton.....
52194	----	Arm Shaft (horizontal) Flanged Bushing (back) Oil Pad (outside) felt.....

No.	Plate	Name
448C	5875	Arm Shaft (horizontal) Flanged Bushing (back) Set Screw.....
52195	----	Arm Shaft (horizontal) Flanged Bushing (front).....
52196	----	Arm Shaft (horizontal) Flanged Bushing (front) 52195 with 52193 and 52198.
52193	----	Arm Shaft (horizontal) Flanged Bushing (front) Oil Pad (inside).....
52198	----	Arm Shaft (horizontal) Flanged Bushing (front) Oil Pad (outside).....
435C	7691	Arm Shaft (horizontal) Flanged Bushing (front) Set Screw.....
54897	5900	Arm Shaft (horizontal) Front Bearing Oil Cup.....
52060	5898	Arm Shaft (horizontal) Gear with two 1036C.....
52071	5894	Arm Shaft (horizontal) Gear Case (two pieces) with 121E and 50234E.....
50234E	7691	Arm Shaft (horizontal) Gear Case Plug Screw.....
121E	7691	Arm Shaft (horizontal) Gear Case Screw...
1036C	5948	" " " " Set Screw...
144D	5875	" " " " Screw.....
52062	5898	" " (upright).....
56099	5898	" " " Bushing (lower).....
432C	5898	" " " " " Set Screw.....
56100	5898	Arm Shaft (upright) Bushing (upper).....
1149C	5875	" " " " " Set Screw.....
56013	5898	Arm Shaft (upright) Gear (lower) with two 1253C.....
1253C	5869	Arm Shaft (upright) Gear (lower) Set Screw.....
56101	5898	Arm Shaft (upright) Gear (upper) with two 1253C.....
1253C	5869	Arm Shaft (upright) Gear (upper) Set Screw.....
58015	5900	Arm Shaft (upright) Oil Tube (lower)....
56015	5900	" " " " (upper)....
12480	5894	" Side Cap.....
219D	5875	" " " Screw.....
12193	5894	" " Cover.....
50053D	7698	" " " Thumb Screw.....
12403	5900	" Spool Pin and Thread Eyelet.....
8879	5936	" " " Washer (cloth).....
52042	5896	" Top Cover.....
52043	5896	" " " 52042 with 12403 and 24131
180D	5875	" " " Screw.....
52005	5893	Balance Wheel (power) light rim, 2 3/16 in. pulley with two 448C.....
52081	5893	Balance Wheel (stand) heavy rim, 2 11/16 in. pulley with two 448C.....

No.	Plate	Name
52063	5894	Balance Wheel Oil Cover.....
210D	5875	" " " " Screw.....
448C	5875	" " " " Set Screw.....
*52383	----	Bed.....
12431	----	" Slide.....
12432	5894	Bed Slide complete, Nos. 4307, 12431 and two 725J.....
4307	5894	Bed Slide Spring.....
725J	5875	" " " " Screw.....
52051	----	Face Plate.....
52052	5894	Face Plate complete, Nos. 52051, 52053, 52170 and two 226J.....
190J	5875	Face Plate Screw.....
52053	5900	" " " " Thread Guard (lower).....
226J	5900	" " " " " " Screw....
52170	----	" " " " " " (upper).....
226J	5900	" " " " " " " " Screw....
50190D	7691	" " " " Thumb Screw.....
52452	7694	Feed Bar.....
313C	5875	" " " " Screw Center.....
1519J	5942	" " " " " " Nut.....
3033	7695	" " " " " " Connecting Link.....
375C	7695	" " " " " " Hinge Screw.....
1518J	7695	" " " " " " " " Nut....
52073	5897	" " " " " " Stud.....
50083C	5897	" " " " " " " " Set Screw
44136	5805	" " " " " " Dog.....
12370	778	" " " " " " " " for cloth, 15 teeth (16 teeth to the inch).....
12425	5932	Feed Dog, for cloth.....
12450	5933	" " " " " " 11 teeth (18 teeth to the inch).....
20348	5933	Feed Dog, for chiffon, 22 teeth (36 teeth to the inch).....
20106	1259	Feed Dog, for cloth.....
20119	1259	" " " " " " heavy work on duck, overalls, etc.....
20158	1262	Feed Dog, for shirt work, 17 teeth (16 teeth to the inch).....
20151	1262	Feed Dog, for shirt work, beveled for hemmer, 13 teeth (14 teeth to the inch).....
20117	5933	Feed Dog, for shirt work, beveled for hemmer, 16 teeth (16 teeth to the inch).....
20138	1263	Feed Dog, for shirt work, beveled for hemmer, 13 teeth (12 teeth to the inch).....
20162	1263	Feed Dog, for shirt work, beveled for hemmer, 17 teeth (16 teeth to the inch).....
20147	5933	Feed Dog, 12 teeth (14 teeth to the inch)

No.	Plate	Name
12481	778	Feed Dog, for general work, 18 teeth (16 teeth to the inch).....
50117E	5875	Feed Dog Screw.....
20283	5947	" " " " " " and Feed Lifting Eccentric with 448C.....
448C	5942	Feed and Feed Lifting Eccentric Set Screw.....
127152	----	Feed and Feed Lifting Eccentric Sleeve..
20284	5947	" " " " " " Forked Connection.....
375C	7695	" " " " " " Hinge Screw.....
1518J	7695	" " " " " " Connecting Link Hinge Screw Nut....
52384	5948	" " " " " " Lifting Rock Shaft.....
52385	----	Feed Lifting Rock Shaft complete, Nos. 12376 and 52384.....
127156	----	Feed Lifting Rock Shaft Connecting Rod with two 966E.....
966E	7691	Feed Lifting Rock Shaft Connecting Rod Cap Screw.....
375C	7695	Feed Lifting Rock Shaft Connecting Rod Hinge Screw.....
1518J	5897	Feed Lifting Rock Shaft Connecting Rod Hinge Screw Nut.....
*52271	----	Feed Lifting Rock Shaft Crank.....
12376	7692	" " " " " " " " 52271 with 157J and 1813.....
157J	5897	Feed Lifting Rock Shaft Crank Clamping Screw.....
1813	7692	Feed Lifting Rock Shaft Crank Roller and Stud.....
50191C	7691	Feed Lifting Rock Shaft Screw Center....
1513J	5942	" " " " " " " " " " Nut
52074	5897	" " " " " " Regulator with 50083C.....
1128E	5897	" " " " " " Hinge Screw.....
818D	5897	" " " " " " Thumb Screw.....
52359	5948	" " " " " " " " Stop.....
52386	5948	" " " " " " Rock Shaft.....
52387	----	Feed Rock Shaft complete, Nos. 29633 and 52386.....
29633	5897	Feed Rock Shaft Crank with 157J.....
157J	5897	" " " " " " Clamping Screw....
50191C	7691	" " " " " " Screw Center.....
1513J	5942	" " " " " " " " Nut.....
25866	6449	Guide.....
732D	5875	" " " " " " Thumb Screw.....
52455	7698	Needle Bar (hollow).....
52305	5948	" " " " " " Bushing (lower) with 29533...
1133E	5948	" " " " " " " " Set Screw....
52014	5948	" " " " " " (upper).....
1133E	5948	" " " " " " " " Set Screw....
24040	5948	" " " " " " Connecting Link with 794E....
794E	5948	" " " " " " " " Adjusting Screw.....

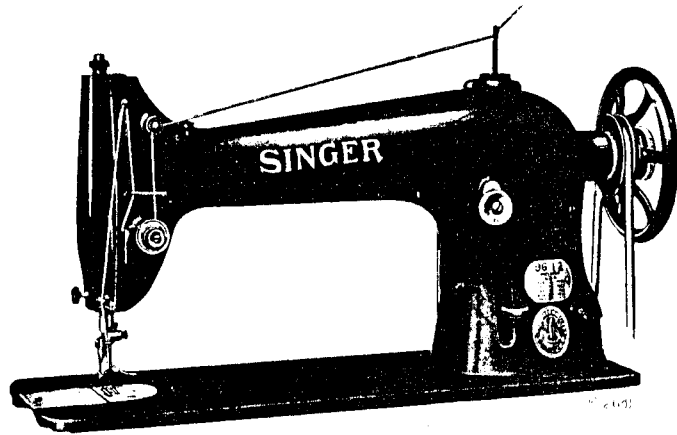
No.	Plate	Name
775E	5948	Needle Bar Connecting Link Cap Screw...
24041	5948	" " " Stud with 207E...
207E	5948	" " " Clamping Screw.....
24052	7694	Needle Bar Crank with 1036C, 1037C and 1065C.....
1065C	5875	Needle Bar Crank Position Screw.....
29532	5948	" " Oil Cup.....
52306	5948	" " Thread Guard.....
229J	5948	" " " Screw.....
52307	5948	" Clamp with 51460F.....
51460F	----	" " Screw.....
12391	5896	Presser Bar (hollow).....
52338	5936	" " Guide Bracket with 223C and 453C.....
453C	5936	Presser Bar Guide Bracket Set Screw....
52016	5936	" " Lifter.....
689C	5936	" " " Screw.....
1520J	5936	" " " Nut.....
12327	5936	" " Lifting and Releasing Lever Bracket.....
11167	5896	Presser Bar Spring.....
11170	5936	" " " Washer.....
20458	5949	" Foot for 44136.....
12143	5864	" " " 20106.....
12335	5949	" " (narrow) for 20106.....
12258	5949	" " (wide) for 20106.....
12142	5949	" " for 12370.....
12259	5949	" " " 12425.....
12144	5864	" " " 20117, 20138, 20147, 20151, 20158 and 20162.....
12260	5864	Presser Foot for 12450, 20147 and 20348.
12474	5949	" " " 20138 and 20162.....
20342	5949	" " " 12450 and 20348.....
20343	5949	" " with guide on bottom to the right of needle hole, for 12450, and 20348.....
12261	5864	Presser Foot for 12481.....
62527	7698	" " Hinge Pin.....
24544	----	" " Plate.....
24982	----	" " Shank.....
26231	5900	" " Spring.....
24983	5867	Presser Foot (spring hinged) complete for 12425 and 20119, Nos. 24544, 24982, 26231 and 62527.....
7298	5900	Presser Foot Hinge Pin.....
19334	----	" " Plate.....
19335	----	" " Shank.....
19336	5938	Presser Foot (hinged) complete for 12370, Nos. 7298, 19334 and 19335.
7298	5900	Presser Foot Hinge Pin.....
20268	----	" " Plate.....

No.	Plate	Name
20269	----	Presser Foot Shank.....
20270	5938	Presser Foot (hinged) complete for 20106 Nos. 7298, 20268 and 20269.....
62527	7698	Presser Foot Hinge Pin.....
20310	----	" " Plate.....
19223	----	" " Shank.....
20311	5949	Presser Foot (hinged) complete for 20117 20138, 20147, 20151, 20158 and 20162, Nos. 19223, 20310 and 62527.....
62527	7698	Presser Foot Hinge Pin.....
20344	----	" " Plate.....
20345	----	" " Shank.....
26231	5900	" " Spring.....
20346	5949	Presser Foot (spring hinged) complete for 20117, 20138, 20147, 20151, 20158 and 20162, Nos. 20344, 20345, 26231 and 62527.....
190J	5875	Presser Foot Screw.....
688J	5875	Pressure Regulating Thumb Screw.....
52121	----	Rotating Hook with three 1253C.....
52123	----	" " 52121 with 52090 and four 1053E.....
127060	----	Rotating Hook 52123 with 40274, 127100 and three 1367E.....
52478	----	Rotating Hook 127060 with 52473.....
52089	5898	" " 52123 with 40274 and three 1367E (For Agents Only).....
40264	5869	Rotating Hook Bobbin.....
52472	----	" " " Case.....
52481	----	" " " " 52472 with 591F, 1380E and 40394.....
40392	5869	Rotating Hook Bobbin Case Latch.....
125320	----	" " " " " Lever...
2974	5869	" " " " " " Fulcrum Pin.....
2975	5869	Rotating Hook Bobbin Case Latch Spring..
592E	5869	" " " " " " Stop Screw.....
40393	----	Rotating Hook Bobbin Case Hinge, Nos. 2974, 40392 and 125320.....
591F	5869	Rotating Hook Bobbin Case Tension Regulating Screw.....
40394	5869	Rotating Hook Bobbin Case Tension Spring
1380E	5869	" " " " " " Screw.....
52473	----	Rotating Hook Bobbin Case complete, Nos. 592E, 2975, 40393 and 52481.....
127099	----	Rotating Hook Bobbin Case 52473 with 127100 (For Agents Only).....
127100	----	Rotating Hook Bobbin Case Holder with 52475 and two 52476.....

No.	Plate	Name
52018	5869	Rotating Hook Bobbin Case Holder Position Bracket.....
704J	5869	Rotating Hook Bobbin Case Holder Position Bracket Screw.....
*52475	----	Rotating Hook Bobbin Case Locating Plate
*52476	----	" " " " " " Rivet.....
40274	5869	Rotating Hook Section.....
1367E	5869	" " " Screw.....
1253C	5869	" " " Set Screw.....
52388	5946	" " " Shaft.....
56106	5898	" " " Bushing (back).....
52045	5898	" " " " " Packing (cotton).....
1143C	7697	Rotating Hook Shaft Bushing (back) Set Screw.....
58107	5898	Rotating Hook Shaft Bushing (front).....
52045	5898	" " " " " Packing (cotton).....
1148C	5898	Rotating Hook Shaft Bushing (front) Set Screw.....
58013	5898	Rotating Hook Shaft Gear with two 1253C.
52072	5894	" " " " Case (two pieces) with 121E and 50234E.....
50234E	7691	Rotating Hook Shaft Gear Case Plug Screw
121E	7691	" " " " " Screw.....
1253C	5869	" " " " " Set Screw.....
52090	5898	" " " Thread Guard.....
1053E	5869	" " " " " Screw.....
52337	5936	Slack Thread Regulator.....
223C	5936	" " " " " Set Screw.....
52046	5947	Spool Holder Base.....
389D	5942	" " " " " Screw.....
204296	5947	" " " " " Wire.....
200079H	5942	" " " " " Hinge Screw.....
52047	5947	Spool Holder complete, Nos. 52046, 200079H and 204296.....
2102	7692	Tension Disc.....
1560C	7692	" " " " " Regulating Thumb Nut.....
32572	7692	" " " " " Releasing Disc.....
43944	5936	" " " " " Lever.....
12393	5936	" " " " " Hinge Pin.....
12329	5936	" " " " " Spring.....
32574	7692	" " " " " Pin.....
2103	7692	" " " " " Spring.....
50304C	7692	" " " " " Stud.....
52098	----	" " " 50304C with 1560C.....
50305C	7692	" " " " " Set Screw.....
52397	----	Tension complete, Nos. 2103, 32572, 32574, 52083, 52098, 52394 and two 2102.....
52027	7692	Thread Guard (side of arm).....
52454	7698	" " " " " Retainer.....
460C	7691	" " " " " Set Screw.....

No.	Plate	Name
52021	5948	Thread Take-up Crank.....
1037C	5948	" " " " " Position Screw.....
1036C	5948	" " " " " Set Screw.....
52022	5948	" " " " " Lever with 52130.....
52023	5948	" " " " " Hinge Pin.....
52024	5948	" " " " " Link.....
11204	5948	" " " " " Hinge Pin.....
435C	7691	" " " " " " " " Set Screw.....
5213C	----	Thread Take-up Lever Thread Eyelet Bushing.....
52025	----	Thread Take-up Lever complete, Nos. 52022 to 52024.....
52394	5948	Thread Take-up Spring.....
52083	7692	" " " " " Regulator with 50305C.....
443C	5875	Thread Take-up Spring Regulator Set Screw.....
44137	5805	Throat Plate, large needle hole, for 44138
44138	----	" " " " " small needle hole, for 44138
12412	778	" " " " " large needle hole, for 12370
12426	5932	" " " " " " " " 12425
12466	----	" " " " " small needle hole, for 12425
12464	5933	" " " " " large needle hole, for 12450 and 20348.....
12451	----	Throat Plate, small needle hole, for 12450 and 20348.....
20315	----	Throat Plate, large needle hole, for 20106
20107	1259	" " " " " small needle hole, for 20106
20120	1259	" " " " " large oblong needle hole, for 20119.....
20187	----	Throat Plate, small oblong needle hole, for 20119.....
19497	5933	Throat Plate, large needle hole, for 20117
19405	----	" " " " " small needle hole, for 20117
19409	----	" " " " " large needle hole, for 20138 and 20162.....
19410	1263	Throat Plate, small needle hole, for 20138 and 20162.....
19415	1262	Throat Plate, large needle hole, for 20151
19416	----	" " " " " small needle hole, for 20151
19413	1262	" " " " " large needle hole, for 20158
19419	----	" " " " " small needle hole, for 20158
19412	5933	" " " " " large needle hole, for 20147
19413	----	" " " " " small needle hole, for 20147
12482	----	" " " " " large needle hole, for 12481
12483	778	" " " " " small needle hole, for 12481
691F	5875	" " " " " Screw.....
44212	----	Drip Pan with four 1 in. wire nails.....
*15404	----	Trade Mark.....
15405	----	" " " " " Rivet.....

LIST OF PARTS COMPLETE
FOR



MACHINE No. 96-12

FOR CLOAKS, CLOTHING, OVERALLS AND OTHER
WORK IN CLOTH. HAS REVERSIBLE FEED MECHANISM.
SPEED 3200 R. P. M.

No.	Plate	Name
*52432	----	Arm with two 56015.....
16532	5943	" Dowel Pin.....
24131	5900	" Oil Tube with 52045, for oiling 127152.....
11119	5900	Arm Oil Tube with 52045, for oiling 52022
12454	5900	" " " " 132590, for oiling 52024
24131	5900	" " " " 52045, for oiling 127156, for 52043.....
52045	5898	Arm Oil Tube Packing (cotton) for 11119 and 24131.....
132590	----	Arm Oil Tube Packing (w/ck) for 12454...
116E	5875	" Screw (back).....
854E	5942	" " (front).....
52382	5946	" Shaft (horizontal) for 52005 and 52081.....
52400	7690	Arm Shaft (horizontal) for 52405.....
52191	----	" " " Flanged Bushing (back).....
52192	----	Arm Shaft (horizontal) Flanged Bushing (back) 52191 with 52193 and 52194..
52401	7694	Arm Shaft (horizontal) Flanged Bushing (back) for 52405.....

No.	Plate	Name
52193	----	Arm Shaft (horizontal) Flanged Bushing (back) Oil Pad (inside) braided cotton.....
52194	----	Arm Shaft (horizontal) Flanged Bushing (back) Oil Pad (outside) felt.....
448C	5875	Arm Shaft (horizontal) Flanged Bushing (back) Set Screw.....
52195	----	Arm Shaft (horizontal) Flanged Bushing (front).....
52196	----	Arm Shaft (horizontal) Flanged Bushing (front) 52195 with 52193 and 52198.
52193	----	Arm Shaft (horizontal) Flanged Bushing (front) Oil Pad (inside).....
52198	----	Arm Shaft (horizontal) Flanged Bushing (front) Oil Pad (outside).....
435C	7691	Arm Shaft (horizontal) Flanged Bushing (front) Set Screw.....
54897	5900	Arm Shaft (horizontal) Front Bearing Oil Cup.....
52060	5898	Arm Shaft (horizontal) Gear with two 1036C.....
52071	5894	Arm Shaft (horizontal) Gear Case (two pieces) with 121E and 50234E.....
50234E	7691	Arm Shaft (horizontal) Gear Case Plug Screw.....
121E	7691	Arm Shaft (horizontal) Gear Case Screw..
1036C	5948	" " " " Set Screw...
144D	5875	" " " " Screw.....
52062	5898	" " (upright).....
56099	5898	" " " " Bushing (lower).....
432C	5898	" " " " " Set Screw.....
56100	5898	Arm Shaft (upright) Bushing (upper).....
1149C	5875	" " " " " Set Screw.....
56013	5898	Arm Shaft (upright) Gear (lower) with two 1253C.....
1253C	5869	Arm Shaft (upright) Gear (lower) Set Screw.....
56101	5898	Arm Shaft (upright) Gear (upper) with two 1253C.....
1253C	5869	Arm Shaft (upright) Gear (upper) Set Screw.....
56015	5900	Arm Shaft (upright) Oil Tube (lower)....
56015	5900	" " " " " (upper)....
12480	5894	" Side Cap.....
219D	5875	" " " Screw.....
12193	5894	" " Cover.....
51224W	----	" " " Thumb Screw.....
12403	5900	" Spool Pin and Thread Eyelet.....
8879	5936	" " " Washer (cloth).....
52042	5896	" Top Cover.....
52043	5896	" " " 52042 with 12403 and 24131.

	Name
Feed Fork	d Connection Hinge Screw.....
" "	" " " " Nut..
" Lift	ing Rock Shaft.....
Feed Lift	ing Rock Shaft complete, Nos.
1237	and 52384.....
Feed Lift	ing Rock Shaft Connecting Rod
with	two 966E.....
Feed Lift	ing Rock Shaft Connecting Rod
Cap	Screw.....
Feed Lift	ing Rock Shaft Connecting Rod
Hing	Screw.....
Feed Lift	ing Rock Shaft Connecting Rod
Hing	Screw Nut.....
Feed Lift	ing Rock Shaft Crank.....
" "	" " " 52271 with
157J	and 1813.....
Feed Lift	ing Rock Shaft Crank Clamping
Scre	W.....
Feed Lift	ing Rock Shaft Crank Roller and
Stud
Feed Lift	ing Rock Shaft Screw Center....
" "	" " " " Nut
" Regu	lating Stud.....
"	" " Head with 56033....
"	" " " Cap Screw....
"	" " " Stop Pin.....
"	" " " Lock Pin.....
"	" " " " Spring....
" Regu	lator with 50083C.....
"	" Hinge Screw.....
" Reve	rse Lever with 158E and 51846..
"	" " Hinge Screw.....
"	" " " " Clamping
Scre	W.....
Feed Reve	rse Lever Hinge Screw Friction
Wash	er.....
Feed Reve	rse Lever Roller and Stud.....
" Rock	Shaft.....
Feed Rock	Shaft complete, Nos. 29633 and
523E	6.....
Feed Rock	Shaft Crank with 157J.....
" "	" " Clamping Screw....
" "	" Screw Center.....
" "	" " " " Nut.....
Guide...
" Thu	mb Screw.....
Needle Be	r (hollow).....
" "	Bushing (lower) with 29532...
" "	" " Set Screw....
" "	" (upper).....
" "	" Set Screw....
" "	Connecting Link with 794E....

No.	Plate	Name
794E	5948	Needle Bar Connecting Link Adjusting Screw.....
775E	5948	Needle Bar Connecting Link Cap Screw....
24041	5948	" " " Stud with 207E....
207E	5948	" " " Clamping Screw
24052	7894	" " Crank with 1036C 1037C and 1065C.....
1065C	5875	Needle Bar Crank Position Screw.....
29532	5948	" " Oil Cup.....
52306	5948	" " Thread Guard.....
229J	5948	" " " Screw.....
52307	5948	" Clamp with 51460F.....
51460F	----	" " Screw.....
12391	5896	Presser Bar (hollow).....
52338	5936	" " Guide Bracket with 223C and 453C.....
453C	5936	Presser Bar Guide Bracket Set Screw....
52016	5936	" " Lifter.....
689C	5936	" " " Screw.....
1520J	5936	" " " Nut.....
12327	5936	" " Lifting and Releasing Lever Bracket.....
11167	5896	Presser Bar Spring.....
11170	5936	" " " Washer.....
82527	7698	" Foot Hinge Pin.....
52426	----	" " Plate.....
52390	----	" " Shank.....
26231	5900	" " Spring.....
52427	7696	Presser Foot (spring hinged) complete, Nos.26231,52390,52426 and 62527....
190J	5875	Presser Foot Screw.....
688J	5875	Pressure Regulating Thumb Screw.....
52121	----	Rotating Hook with three 1253C.....
52123	----	" " 52121 with 52090 and four 1053E.....
127060	----	Rotating Hook 52123 with 40274,127100 and three 1367E.....
52478	----	Rotating Hook 127060 with 52473.....
52089	5898	" " 52123 with 40274 and three 1367E (For Agents Only).....
40264	5869	Rotating Hook Bobbin.....
52472	----	" " " Case.....
52481	----	" " " " 52472 with 591F,1380E and 40394.....
40392	5869	Rotating Hook Bobbin Case Latch.....
125320	----	" " " " " Lever...
2974	5869	" " " " " " Fulcrum Pin.....
2975	5869	Rotating Hook Bobbin Case Latch Spring..
592E	5869	" " " " " Stop Screw.....
40393	----	Rotating Hook Bobbin Case Hinge, Nos 2974,40392 and 125320.....

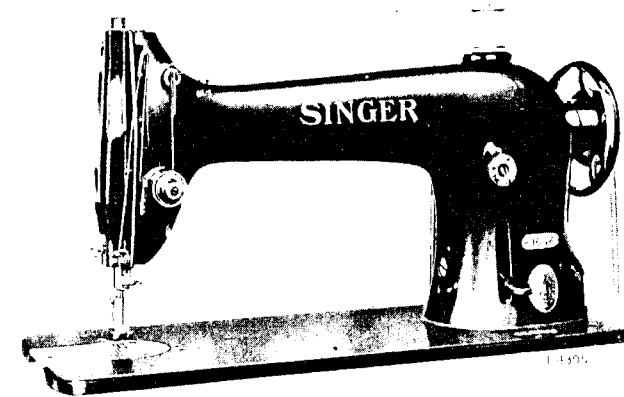
No.	Plate	Name
591F	5869	Rotating Hook Bobbin Case Tension Regulating Screw.....
40394	5869	Rotating Hook Bobbin Case Tension Spring.....
1380E	5869	Rotating Hook Bobbin Case Tension Spring Screw.....
52473	----	Rotating Hook Bobbin Case complete,Nos. 592E,2975,40393 and 52481.....
127099	----	Rotating Hook Bobbin Case 52473 with 127100 (For Agents Only).....
127100	----	Rotating Hook Bobbin Case Holder with 52475 and two 52476.....
52018	5869	Rotating Hook Bobbin Case Holder Position Bracket.....
704J	5869	Rotating Hook Bobbin Case Holder Position Bracket Screw.....
*52475	----	Rotating Hook Bobbin Case Locating Plate.....
*52476	----	Rotating Hook Bobbin Case Locating Plate Rivet.....
40274	5869	Rotating Hook Section.....
1367E	5869	" " " Screw.....
1253C	5869	" " Set Screw.....
52388	5946	" " Shaft.....
56106	5898	" " " Bushing (back)....
52045	5898	" " " " " Pack- ing (cotton).....
1143C	7697	Rotating Hook Shaft Bushing (back) Set Screw.....
56107	5898	Rotating Hook Shaft Bushing (front)....
52045	5898	" " " " " Pack- ing (cotton).....
1148C	5898	Rotating Hook Shaft Bushing (front) Set Screw.....
56013	5898	Rotating Hook Shaft Gear with two 1253C
52072	5894	" " " " Case (two pieces) with 121E and 50234E.....
50234E	7691	Rotating Hook Shaft Gear Case Plug Screw.....
121E	7691	Rotating Hook Shaft Gear Case Screw....
1253C	5869	" " " " Set Screw....
52090	5898	" " Thread Guard.....
1053E	5869	" " " " Screw.....
52337	5936	Slack Thread Regulator.....
223C	5936	" " " Set Screw.....
2102	7692	Tension Disc.....
1560C	7692	" Regulating Thumb Nut.....
32572	7692	" Releasing Disc.....
43944	5936	" " Lever.....
12398	5936	" " " Hinge Pin.....
12329	5936	" " " Spring.....
32574	7692	" " Pin.....
2103	7692	" Spring.....

No.	Plate	Name
50304C	7692	Tension Stud.....
52098	----	" " 50304C with 1560C.....
50305C	7692	" " Set Screw.....
52397	----	Tension complete, Nos. 2103, 32572, 32574, 52083, 52098, 52394 and two 2102.....
52027	7692	Thread Guard (side of arm).....
52454	7698	" Retainer.....
460C	7691	" " Set Screw.....
52021	5948	" Take-up Crank.....
1037C	5948	" " " Position Screw.....
1036C	5948	" " " Set Screw.....
52022	5948	" " Lever with 52130.....
52023	5948	" " " Hinge Pin.....
52024	5948	" " " Link.....
11204	5948	" " " Hinge Pin.....
435C	7631	" " " " " " Set Screw.....
52130	----	Thread Take-up Lever Thread Eyelet Bush- ing.....
52025	----	Thread Take-up Lever complete, Nos. 52022 to 52024.....
52394	5948	Thread Take-up Spring.....
52083	7692	" " " Regulator with 50305C.....
448C	5875	Thread Take-up Spring Regulator Set Screw.....
26605	769E	Throat Plate, large needle hole, for 26603 28360 and 120001.....
26606	----	Throat Plate, small needle hole, for 26603 28360 and 120001.....
691F	5875	Throat Plate Screw.....
44212	----	Drip Pan with four 1 in. wire nails.....
15404	----	Trade Mark.....
15405	----	" " Rivet.....

Genuine Singer Needles should be used
in Singer Machines.
These Needles and their Containers
are marked with the
Company's Trade Mark "SIMANCO." 1

Needles in Containers marked
"For Singer Machines"
are not Singer made needles. 2

LIST OF PARTS COMPLETE
FOR



MACHINE No. 96-16

FOR WORK ON OVERALLS, HEAVY OVERCOATS,
KHAKI AND OTHER HEAVY MATERIALS. HAS REVERSI-
BLE FEED MECHANISM. LIFT OF PRESSER FOOT 7/16
INCH. SPEED 3200 R. P. M.

No.	Plate	Name
*52432	----	Arm with two 56015.....
16532	5943	" Dowel Pin.....
24131	5900	" Oil Tube with 52045, for oiling 127152.....
11119	5900	Arm Oil Tube with 52045, for oiling 52022
12454	5900	" " " " 132590, for oiling 52024
24131	5900	" " " " 52045, for oiling 127156, for 52042.....
52045	5898	Arm Oil Tube Packing (cotton) for 11119 and 24131.....
132590	----	Arm Oil Tube Packing (wick) for 12454...
116E	5875	" Screw (back).....
854E	5942	" " (front).....
52382	5946	" Shaft (horizontal).....
52191	----	" " " Flanged Bushing (back).....
52192	----	Arm Shaft (horizontal) Flanged Bushing (back) 52191 with 52193 and 52194..

No.	Plate	Name
52193	----	Arm Shaft (horizontal) Flanged Bushing (back) Oil Pad (inside) braided cotton.....
52194	----	Arm Shaft (horizontal) Flanged Bushing (back) Oil Pad (outside) felt.....
448C	5875	Arm Shaft (horizontal) Flanged Bushing (back) Set Screw.....
52195	----	Arm Shaft (horizontal) Flanged Bushing (front).....
52196	----	Arm Shaft (horizontal) Flanged Bushing (front) 52195 with 52193 and 52198.
52193	----	Arm Shaft (horizontal) Flanged Bushing (front) Oil Pad (inside).....
52198	----	Arm Shaft (horizontal) Flanged Bushing (front) Oil Pad (outside).....
435C	7891	Arm Shaft (horizontal) Flanged Bushing (front) Set Screw.....
54897	5900	Arm Shaft (horizontal) Front Bearing Oil Cup.....
52060	5898	Arm Shaft (horizontal) Gear with two 1036C.....
52071	5894	Arm Shaft (horizontal) Gear Case (two pieces) with 121E and 50234E.....
50234E	7891	Arm Shaft (horizontal) Gear Case Plug Screw.....
121E	7891	Arm Shaft (horizontal) Gear Case Screw..
1036C	5948	" " " " Set Screw...
144D	5875	" " " " Screw.....
52062	5898	" " (upright).....
56099	5898	" " " " Bushing (lower)....
432C	5898	" " " " " " Set Screw.....
56100	5898	Arm Shaft (upright) Bushing (upper)....
1143C	5875	" " " " " " Set Screw.....
56013	5898	Arm Shaft (upright) Gear (lower) with two 1253C.....
1253C	5869	Arm Shaft (upright) Gear (lower) Set Screw.....
56101	5898	Arm Shaft (upright) Gear (upper) with two 1253C.....
1253C	5869	Arm Shaft (upright) Gear (upper) Set Screw.....
56015	5900	Arm Shaft (upright) Oil Tube (lower)....
56015	5900	" " " " " " (upper)....
12480	5894	" Side Cap.....
219D	5875	" " " " Screw.....
12193	5894	" " " " Cover.....
51224W	----	" " " " Thumb Screw.....
12403	5900	" Spool Pin and Thread Eyelet.....
8879	5836	" " " " Washer (cloth).....
52042	5896	" Top Cover.....
52043	5896	" " " " 52042 with 12403 and 24131.

No.	Plate	Name
180D	5875	Arm Top Cover Screw.....
52005	5893	Balance Wheel (power) light rim, 2 3/16 in. pulley, with two 448C.....
52063	5894	Balance Wheel Oil Cover.....
210D	5875	" " " " Screw.....
448C	5875	" " " " Set Screw.....
*52383	----	Bed.....
12431	----	" Slide.....
12432	5894	Bed Slide complete, Nos. 4307, 12431 and two 725J.....
4307	5894	Bed Slide Spring.....
725J	5875	" " " " Screw.....
52051	----	Face Plate.....
52052	5894	Face Plate complete, Nos. 52051, 52053, 52170 and two 226J.....
190J	5875	Face Plate Screw.....
52053	5900	" " " " Thread Guard (lower).....
226J	5900	" " " " " " Screw...
52170	----	" " " " " " (upper).....
226J	5900	" " " " " " Screw...
50190D	7891	" " " " Thumb Screw.....
52452	7894	Feed Bar.....
313C	5875	" " " " Screw Center.....
1519J	5942	" " " " " " Nut.....
3033	7895	" " " " " " Connecting Link.....
375C	7895	" " " " " " Hinge Screw.....
1518J	7895	" " " " " " Nut....
52073	7895	" " " " " " Stud.....
50083C	5897	" " " " " " Set Screw
120001	7896	" Dog (spiked teeth).....
50117E	5875	" " " " " " Screw.....
52406	7894	" " " " " " and Feed Lifting Eccentric with 448C.....
448C	5875	Feed and Feed Lifting Eccentric Set Screw.....
127152	----	Feed and Feed Lifting Eccentric Sleeve..
52407	7894	" Forked Connection.....
375C	7895	" " " " " " Hinge Screw.....
1518J	7895	" " " " " " Nut...
52384	5846	" Lifting Rock Shaft.....
52433	----	Feed Lifting Rock Shaft complete, Nos. 52384 and 52434.....
127156	----	Feed Lifting Rock Shaft Connecting Rod with two 966E.....
966E	7891	Feed Lifting Rock Shaft Connecting Rod Cap Screw.....
375C	7895	Feed Lifting Rock Shaft Connecting Rod Hinge Screw.....
1518J	7895	Feed Lifting Rock Shaft Connecting Rod Hinge Screw Nut.....
52434	7897	Feed Lifting Rock Shaft Crank with 157J and 1813.....

No.	Plate	Name
157J	7892	Feed Lifting Rock Shaft Crank Clamping Screw.....
1813	7892	Feed Lifting Rock Shaft Crank Roller and Stud.....
50191C	7891	Feed Lifting Rock Shaft Screw Center....
1513J	5942	" " " " " " Nut
50338E	7895	" Regulating Stud.....
58032	7895	" " " Head with 56033....
50193J	7895	" " " Cap Screw.....
58033	7895	" " " Stop Pin.....
58034	7895	" " " Lock Pin.....
56035	7895	" " " " " Spring....
52408	7895	" Regulator with 50083C.....
1128E	7895	" " Hinge Screw.....
52409	7895	" Reverse Lever with 158E and 5184E..
50339D	7895	" " " Hinge Screw.....
158E	5943	" " " " " Clamping Screw.....
52410	7895	Feed Reverse Lever Hinge Screw Friction Washer.....
5184E	----	Feed Reverse Lever Roller and Stud.....
52386	5946	" Rock Shaft.....
52387	----	Feed Rock Shaft complete, Nos. 29633 and 52388.....
29633	7892	Feed Rock Shaft Crank with 157J.....
157J	7892	" " " " Clamping Screw....
50191C	7891	" " " " Screw Center.....
1513J	5942	" " " " " Nut.....
25866	6449	Guide.....
50190D	7691	" Thumb Screw.....
52455	7698	Needle Bar (hollow).....
52305	5948	" " Bushing (lower) with 29532...
1133E	5948	" " " " Set Screw....
52448	7697	" " " (upper).....
1133E	5948	" " " " Set Screw....
24040	5948	" " Connecting Link with 794E....
794E	5948	" " " " Adjusting Screw.....
775E	5948	Needle Bar Connecting Link Cap Screw....
24041	5948	" " " Stud with 207E....
207E	5948	" " " " Clamping Screw.....
127222	----	Needle Bar Crank with 1036C, 1037C and 1065C.....
1065C	5875	Needle Bar Crank Position Screw.....
29532	5948	" " Oil Cup.....
52306	5948	" " Thread Guard.....
229J	5948	" " " " Screw.....
52307	5948	" Clamp with 51460F.....
51460F	----	" " Screw.....
12391	5896	Presser Bar (hollow).....
52338	5936	" " Guide Bracket with 223C and 453C.....

No.	Plate	Name
453C	5936	Presser Bar Guide Bracket Set Screw.....
5990	7697	" " Lifter.....
689C	5936	" " " Screw.....
1520J	5936	" " " Nut.....
12327	5936	" " Lifting and Releasing Lever Bracket.....
11167	5896	Presser Bar Spring.....
11170	5936	" " " Washer.....
7298	5900	" Foot Hinge Pin.....
52437	----	" " Plate.....
52438	----	" " Shank.....
26231	5900	" " Spring.....
52439	7697	Presser Foot (spring hinged) complete, Nos. 7298, 26231, 52437 and 52438....
190J	5875	Presser Foot Screw.....
688J	5875	Pressure Regulating Thumb Screw.....
52121	----	Rotating Hook with three 1253C.....
52123	----	" " 52121 with 52090 and four 1053E.....
52440	7697	Rotating Hook 52123 with 52444 and three 1367E (For Agents Only).....
52480	----	Rotating Hook 52440 with 127099.....
40264	5869	" " Bobbin.....
52472	----	" " " Case.....
52481	----	" " " " 52472 with 591F, 1330E and 40394.....
40392	5869	Rotating Hook Bobbin Case Latch.....
125320	----	" " " " " Lever...
2974	5869	" " " " " Fulcrum Pin.....
2975	5869	Rotating Hook Bobbin Case Latch Spring..
592E	5869	" " " " " Stop Screw.....
40393	----	Rotating Hook Bobbin Case Hinge, Nos. 2974 40392 and 125320.....
591F	5869	Rotating Hook Bobbin Case Tension Regulating Screw.....
40394	5869	Rotating Hook Bobbin Case Tension Spring
1380E	5869	" " " " " " Screw.....
52473	----	Rotating Hook Bobbin Case complete, Nos. 592E, 2975, 40393 and 52481.....
127099	----	Rotating Hook Bobbin Case 52473 with 127100 (For Agents Only).....
127100	----	Rotating Hook Bobbin Case Holder with 52475 and two 52476.....
52018	5869	Rotating Hook Bobbin Case Holder Position Bracket.....
704J	5869	Rotating Hook Bobbin Case Holder Position Bracket Screw.....
*52475	----	Rotating Hook Bobbin Case Locating Plate

No.	Plate	Name
*52476	----	Rotating Hook Bobbin Case Locating Plate Rivet.....
52444	7697	Rotating Hook Section.....
1367E	5869	" " " Screw.....
1253C	5869	" " Set Screw.....
52388	5948	" " Shaft.....
56106	5898	" " " Bushing (back).....
52045	5898	" " " " " Packing (cotton).....
1143C	7697	Rotating Hook Shaft Bushing (back) Set Screw.....
56107	5898	Rotating Hook Shaft Bushing (front).....
52045	5898	" " " " " Packing (cotton).....
1148C	5898	Rotating Hook Shaft Bushing (front) Set Screw.....
56013	5898	Rotating Hook Shaft Gear with two 1253C.
52072	5894	" " " " Case (two pieces) with 121E and 50234E.....
50234E	7691	Rotating Hook Shaft Gear Case Plug Screw
121E	7691	" " " " " Screw.....
1253C	5869	" " " " " Set Screw.....
52090	5898	" " Thread Guard.....
1053E	5869	" " " " " Screw.....
52337	5938	Slack Thread Regulator.....
223C	5936	" " " Set Screw.....
2102	7692	Tension Disc.....
1560C	7692	" Regulating Thumb Nut.....
32572	7692	" Releasing Disc.....
52445	7697	" " Lever.....
12398	5936	" " " Hinge Pin.....
12329	5936	" " " Spring.....
32574	7692	" " Pin.....
2103	7692	" Spring.....
50304C	7692	" Stud.....
52098	----	" " 50304C with 1560C.....
50305C	7692	" " Set Screw.....
52397	----	Tension complete, Nos. 2103, 32572, 32574, 52083, 52098, 52394 and two 2102.....
52454	7698	Thread Retainer.....
460C	7691	" " Set Screw.....
52446	7697	" Take-up Crank.....
1037C	5948	" " " Position Screw.....
1036C	5948	" " " Set Screw.....
52022	5948	" " Lever with 52130.....
52023	5948	" " " Hinge Pin.....
52024	5948	" " " Link.....
11204	5948	" " " " " Hinge Pin.....
435C	7691	" " " " " " Set Screw.....
5213C	----	Thread Take-up Lever Thread Eyelet Bushing.....

No.	Plate	Name
52025	----	Thread Take-up Lever complete, Nos. 52022 to 52024.....
52394	5948	Thread Take-up Spring.....
52083	7692	" " " Regulator with 50305C.....
448C	5875	Thread Take-up Spring Regulator Set Screw.....
26605	7698	Throat Plate, large needle hole, for 120001.....
26606	----	Throat Plate, small needle hole, for 120001.....
691F	5875	Throat Plate Screw.....
44212	----	Drip Pan with four 1 in. wire nails.....
*15404	----	Trade Mark.....
15405	----	" " Rivet.....

Genuine Singer Needles should be used in Singer Machines. These Needles and their Containers are marked with the Company's Trade Mark "SIMANCO." 1

Needles in Containers marked "For Singer Machines" are not Singer made needles. 2

MACHINE BASE

No.	Plate	Name
19219	5943	Bed Frame Cushion (leather).....
158C	5943	" " " Screw.....
19220	5943	" " " Spring.....
19226	5943	" " Hinge Connection.....
19398	----	" " " " 19226 with 211E and 19397.....
19397	5943	Bed Frame Hinge Connection Cap.....
211E	5943	" " " " " Screw....
16555	5943	" " " Plate.....
1401C	5943	" " " Rivet.....
20067	819	Bed Frame with two each 16555,19398, four each 19219,19220, six each 1401C, wood screws 1 1/4 in. No. 12 and eight 158C.....

ACCESSORIES

No.	Plate	Name
12361	5943	Machine Hinge Connection.....
44139	5943	" " Plate.....
44140	----	Machine Hinge complete, Nos. 12361, 44139 and wood screw 1 1/4 in. No. 14....
12405	5943	Machine Rest (felt).....
120342	----	Ciler with 120343.....
120343	----	" Spout, 3 1/2 in. long.....
26026	5901	Screw Driver (large).....
26485	5901	" " (small).....
8909	5901	Wrench for 1513 and 1518.....
8908	5901	" " 1519 and 1520.....

FINGER GUARD

No.	Plate	Name
36818	5945	Finger Guard.....
36819	5945	" " Friction Washer.....
50316J	5945	" " Hinge Screw.....
36820	5945	" " Holder with 196J.....
196J	5945	" " Clamping Screw.....
36821	5945	Finger Guard complete, Nos. 36818 to 36820 and 50316J.....

HEMMERS

No.	Plate	Name
120938	----	Hemmer (foot) 3/32 in. hem.....
120803	----	" " 1/8 in. hem.....
120804	----	" " 5/32 in. hem.....
120805	----	" " 3/16 in. hem.....
36122	----	" " 7/32 in. hem.....
120806	----	" " 1/4 in. hem.....
6267	5900	" Folder.....
25888	5900	" Tongue.....

Note: When ordering Nos. 6267 or 25888 state width of hem and No. of hemmer for which it is required.

20117	5933	Feed Dog.....
19497	5933	Throat Plate, large needle hole, for 20117
19405	----	" " small needle hole, for 20117
35710	1252	Hemmer (foot) 3/32 in. hem, with guide on bottom to the right of needle hole.
35682	----	Hemmer (foot) 1/8 in. hem, with guide on bottom to the right of needle hole.
36524	----	Hemmer (foot) 5/32 in. hem, with guide on bottom to the right of needle hole.
35997	----	Hemmer (foot) 3/16 in. hem, with guide on bottom to the right of needle hole.
36309	----	Hemmer (foot) 7/32 in. hem, with guide on bottom to the right of needle hole.
36072	----	Hemmer (foot) 1/4 in. hem, with guide on bottom to the right of needle hole.
35711	1252	Feed Dog for 35682, 35710, 35997, 36072, 36309 and 36524.....
35712	1252	Throat Plate, small needle hole, for 35711

Note: When ordering No. 35712 state width of hem for which it is required.

36162	----	Hemmer (foot) 3/32 in. hem, for China silk etc.....
120898	----	Hemmer (foot) 1/16 in. to 1/8 in. hem, for China silk, etc.....
120911	----	Hemmer (foot) 5/32 in. to 1/4 in. hem, for China silk, etc.....
36434	----	Hemmer (foot) 3/16 in. hem, for China silk etc.....
20158	1262	Feed Dog, for shirt work, for 36162, 36434, 120898 and 120911.....
19418	1262	Throat Plate, large needle hole, for 20158
19419	----	" " small needle hole, for 20158
36413	----	Hemmer (foot) plain bottom, 1/16 in. hem.
36414	----	" " " " 3/32 in. hem.
120837	----	" " " " 1/8 in. hem, slotted for lace.....
36480	----	Hemmer (foot) plain bottom, 5/32 in. hem.
36416	----	" " " " 3/16 in. hem.

PRESSER FEET

No.	Plate	Name
36464	5892	Presser Foot Spring Guide.....
665J	5892	" " " " Screw.....
36465	5892	Presser Foot (right hand, spring guide) with 665J and 36464, for 1/32 in. to 5/16 in. gauge.....
Note: When ordering Nos. 36464 or 36465 state re- quired distance from edge of goods to seam.		
36574	5945	Presser Foot.....
36575	5945	" " 36574 with 36576 and two 50202J.....
36576	5945	Presser Foot Finger Guard.....
50202J	5945	" " " " Screw.....

BOBBIN WINDERS

BOBBIN WINDER

(SWINGING AUTOMATIC, LEFT HAND)

No.	Plate	Name
41913	5902	Bracket with 457C.....
41583	5902	Frame with 457C.....
34105	5902	" Hinge Pin.....
457C	5942	" " " " Set Screw.....
41914	5902	" Spring.....
41585	5902	Pulley with 171D.....
171D	5942	" Set Screw.....
41586	5902	Spindle.....
41587	5902	Stop Latch.....
42614	5902	" " Hinge Stud.....
457C	5942	" " " " Set Screw.....
7958	7697	" " Stop Pin.....
41588	5902	" " Tripping Arm with 185H.....
185H	5942	" " " " Clamping Screw..
41591	5902	Tension Bracket with 460C.....
41592	5902	Tension Bracket complete, Nos. 12403, 24131 41591, 41593 to 41595 and two 2455..
24131	5900	Tension Bracket Oil Tube with 52045.....
52045	5898	" " " " Packing (cotton)
180D	5875	" " Screw.....
12403	5900	" " Spool Pin and Thread Eyelet.....
8879	5936	Tension Bracket Spool Pin Washer (cloth)
2455	2834	" Disc.....
41593	5936	" Spring.....

BOBBIN WINDER

No.	Plate	Name
41594	5936	Tension Stud.....
460C	7691	" " Set Screw.....
41595	5936	" Thread Guide.....
60845	----	Bobbin Winder, Nos. 7958, 34105, 41583, 41585 to 41588, 41913, 41914 and 42614.....
41915	5902	Bobbin Winder 60845 with 880E and 25446.
41916	----	Bobbin Winder (swinging automatic, left hand) complete, Nos. 41592 and 41915.
880E	7697	Bobbin Winder Screw.....
25446	5900	" " " Washer.....

BOBBIN WINDER

(SWINGING AUTOMATIC, RIGHT HAND)

No.	Plate	Name
52042	5896	Arm Top Cover.....
52043	5896	" " " 52042 with 12403 and 24131
24131	5900	" " " Oil Tube with 52045.....
52045	5898	" " " " Packing (cotton).
180D	5875	" " " Screw.....
12403	5900	" " " Spool Pin and Thread Eye- let.....
8879	5936	Arm Top Cover Spool Pin Washer (cloth)..
41339	2833	Base.....
41340	2833	Frame.....
1429D	2834	" Hinge Screw.....
41341	2833	" Spring.....
207D	2834	" " Screw.....
41342	2833	Pulley with 200F.....
200F	2834	" Set Screw.....
41343	2834	Spindle.....
27306	2834	Spool Pin.....
27307	2833	" Stand.....
27308	2833	Spool Stand complete, Nos. 418E, 1562J, 2106 10141, 11241, 27306, 27307 and two each 2455 and wood screws 1 in. No. 10.....
11241	2833	Spool Washer (cloth).....
41344	2834	Stop Latch.....
41345	2834	" " Finger.....
152F	2834	" " " Screw.....
1430D	2834	" " Hinge Screw.....
1550H	2834	" " " " Nut.....
41346	2834	" " Lever.....
1430D	2834	" " " Hinge Screw.....
2455	2834	Tension Disc.....
1562J	2834	" Regulating Thumb Nut.....
418E	2834	" Screw Stud.....

No.	Plate	Name
10141	2834	Tension Spring.....
2106	2834	" Thread Guide.....
60456	----	Bobbin Winder,Nos.152F,207D,1429D,1550H, 41339 to 41346 and three 1430D....
41347	2833	Bobbin Winder,Nos.60456 and two each 9331 and wood screws 1 in.No.10 R.H.B.....
41348	----	Bobbin Winder (swinging automatic, right hand) complete,Nos.27308 and 41347.
9331	2834	Bobbin Winder Washer.....

FOOT LIFTER PARTS

No.	Plate	Name
5596	7694	Bell Crank.....
56848	----	" " 5596 with 5599 and 5601.....
5599	7694	" " Bracket.....
178E	5875	" " " Screw.....
5601	5943	" " Hinge Pin.....
5735	5943	" " Spring.....
5598	7694	Bell Crank complete,Nos.5735 and 56848..
5670	----	Chain,length 26 in.to 35 in.with 56864 and 56865.....
Note: When ordering No. 5670 state length required		
4879	7694	Chain Connecting Link.....
56864	----	" Hook (large).....
56865	----	" " (small).....
12237	5946	Lifting Lever with 448C.....
52028	7694	" " Connecting Rod.....
12416	5936	" " " " Joint.....
76D	5875	" " " " " Hinge Screw.....
1521J	5942	Lifting Lever Connecting Rod Lock Nut...
802D	5875	" " Hinge Screw.....
12241	5936	" " Link.....
766D	5875	" " " Hinge Screw.....
12240	5936	" " Pin.....
448C	5875	" " " Set Screw.....
2763	819	Rock Shaft.....
12242	819	" " Hanger with two wood screws 1 in. No. 10.....
6337	819	Rock Shaft Lifting Bracket with two 356C
12243	819	" " " " Hook.....
7125	819	" " " " Hook.....
356C	5875	" " " " " Set Screw
356C	5875	" " " " " Set Screw....
2770	819	" " Stop Dog with 356C.....
356C	5875	" " " " Set Screw.....
4880	819	Rock Shaft complete,Nos.2763,2770,7125, 12243 and two each 6337 and 12242..

No.	Plate	Name
4881	819	Treadle.....
4882	7694	" Shaft.....
4883	7694	" Spring.....
4884	819	" Stand.....
4885	819	Treadle complete,Nos.4879,4881 to 4884 and two wood screws 1 in. No. 16...
52319	----	Foot Lifter complete,Nos.76D,766D,802D, 1521J,4880,4885,5598,5670,12237, 12240,12241,12416,52028 and two 178E.....

KNEE LIFTER PARTS

No.	Plate	Name
5596	7694	Bell Crank.....
56848	----	" " 5596 with 5599 and 5601.....
5599	7694	" " Bracket.....
178E	5875	" " " Screw.....
5601	5943	" " Hinge Pin.....
5735	5943	" " Spring.....
5598	7694	Bell Crank complete,Nos.5735 and 56848..
12237	5946	Lifting Lever with 448C.....
52028	7694	" " Connecting Rod.....
12416	5936	" " " " " Joint.....
76D	5875	" " " " " Hinge Screw.....
1521J	5942	Lifting Lever Connecting Rod Lock Nut...
802D	5875	" " Hinge Screw.....
12241	5936	" " Link.....
766D	5875	" " " Hinge Screw.....
12240	5936	" " Pin.....
448C	5875	" " " Set Screw.....
2763	5235	Rock Shaft.....
7539	----	" " Hanger with two wood screws 1 in. No. 10.....
2765	5235	Rock Shaft Knee Arm.....
2766	5235	" " " " Hub with 356C.....
356C	5875	" " " " " Set Screw.....
2768	----	Rock Shaft Knee Arm complete,Nos.2765 to 2767.....
2767	5235	Rock Shaft Knee Plate with 356C.....
356C	5875	" " " " " Set Screw.....
6337	819	" " Lifting Bracket with two 356C
2778	5235	" " " " Hook.....
356C	5875	" " " " " Set Screw
356C	5875	" " " " " Set Screw....
2770	5235	" " Stop Dog with 356C.....
356C	5875	" " " " " Set Screw.....
12250	----	Rock Shaft complete,Nos.2763,2768,2778, 6337 and two each 2770 and 7539....

No.	Plate	Name
52320	----	Knee Lifter complete (power table) Nos. 78D, 786D, 802D, 1521J, 5598, 12237, 12240, 12241, 12250, 12416, 52028 and two 178E.....

THREAD UNWINDER

FOR TWO SPOOLS OR TWO LARGE CONES OF THREAD

No.	Plate	Name
225257	----	Spool Rest with 201018C.....
150203	----	" " Cushion (felt).....
225388	----	" " Rod.....
200383C	----	" " Set Screw.....
201018C	----	" " Set Screw.....
202490	----	" Stand with 200383C.....
225391	----	Thread Guide.....
201696J	----	" " Lock Nut.....
225326	----	" " Position Cup.....
225324	----	" " Rod with 208E and 225322..
208E	5942	" " Screw.....
225322	----	" " Washer.....
225258	----	Thread Unwinder complete, Nos. 201696J, 202490, 225257, 225324, 225326, 225388, two each 150203, 225391 and three wood screws 7/8 in. No. 12.....
27739	----	Thread Cone (wood) for large cones, for 225258.....
225390	----	Thread Cone Holder, for inverted cones, for 225258.....

Note: Nos. 27739 and 225390 are used with, but not included in 225258.

OBSOLETE PARTS

No.	Plate	Name
*52399	----	Arm with two 4448, for 96-12 and 96-16 Machines, use 52432.....
52078	5894	Arm Shaft Flanged Bushing (front) for 96-3 Machine, use 52196.....
52059	5894	Arm Shaft (horizontal) Flanged Bushing (back) for 96-10, 96-12 and 96-16 Machines, use 52191.....
52078	5894	Arm Shaft (horizontal) Flanged Bushing (front) for 96-10, 96-12 and 96-16 Machines, use 52196.....

No.	Plate	Name
4448	7692	Arm Shaft (upright) Oil Tube (lower) for 52399.....
4448	7692	Arm Shaft (upright) Oil Tube (upper) for 52399.....
286D	5875	Arm Side Cover Thumb Screw, for 96-12 and 96-16 Machines, use 51224W.....
*52402	----	Bed, for 96-12 and 96-16 Machines, use 52383.....
20021	5235	Drip Pan with four 1 in. wire nails, use 44212.....
56086	5900	Face Plate Thread Guard (upper) use 52170.....
52011	5896	Feed Bar, for 96-3, 96-10 and 96-12 Machines, use 52452.....
50200C	7695	Feed Connecting Link Hinge Stud Set Screw, use 50083.....
12369	5932	Feed Dog, for cloth, 12 teeth (12 teeth to the inch) for 96-10 Machine.....
12457	5932	Feed Dog, for cloth, 16 teeth (16 teeth to the inch) for 96-10 Machine.....
24036	5896	Feed and Feed Lifting Eccentric Sleeve, use 127152.....
12430	5896	Feed Lifting Rock Shaft Connecting Rod with two 966E, use 127156.....
1811	7695	Feed Reverse Lever Roller and Stud, for 52409, use 51846.....
36118	----	Hemmer (foot) 3/32 in. hem, use 120938...
36119	5881	" " 1/8 in. hem, use 120803...
36120	----	" " 5/32 in. hem, use 120804...
36121	----	" " 3/16 in. hem, use 120805...
36749	----	" " 1/4 in. hem, use 120806...
36432	5881	" " 1/8 in. hem, for China silk, etc., use 120898.....
36433	----	Hemmer (foot) 5/32 in. hem, for China silk etc., use 120911.....
36415	5881	Hemmer (foot) plain bottom 1/8 in. hem, use 120803.....
36471	5881	Hemmer (foot) plain bottom 1/8 in. hem, slotted for lace, use 120837.....
52436	7694	Needle Bar Crank with 858C, 1036C, 1037C and 1065C, use 127222.....
858C	5875	Needle Bar Crank Set Screw, for 24052 and 52436.....
808F	5948	" Clamp Screw, use 51460F.....
52078	5889	Rotating Hook with 40274, 40398, two 1253C and three each 1053E and 1367E, use 52089.....
*52091	----	Rotating Hook 52089 with 40408.....
52124	----	" " 52089 with 52442, for 96-3, 96-10 and 96-12 Machines, use 52478.
*52441	----	Rotating Hook 52440 with 52442, use 52480
2777	5235	Rock Shaft complete for 52320, Nos. 2763, 2768, 2770, 2778, 6337 and two 12242..

OBSOLETE PARTS

No.	Plate	Name
40431	----	Rotating Hook Bobbin Case for 40395, use 52472.....
40395	5889	Rotating Hook Bobbin Case complete for 40408 and 52442, Nos. 591F, 592E, 1380E 2975, 40393, 40394 and 40431, use 52473.....
40408	----	Rotating Hook Bobbin Case 40395 with 40396.....
52442	----	Rotating Hook Bobbin Case 40395 with 52443, for 52124 and 52441, use 127099.....
40398	5869	Rotating Hook Bobbin Case Holder, for 40408.....
52443	7697	Rotating Hook Bobbin Case Holder, for 52442, use 127100.....
40409	5869	Rotating Hook Bobbin Case Latch Lever, for 40393, use 125320.....
40398	5869	Rotating Hook Thread Guard, for 52078...
210958	5900	Thread Retaining Collar, for 52379.....
210993	5900	" " Sleeve, for 52379.....
52398	5900	" " Spring, for 52379.....
52378	5900	" " Stud, for 52379.....
52379	----	Thread Retainer complete, Nos. 52378, 52398 210958 and 210993.....
12411	5932	Throat Plate, large needle hole, for 12389 and 12457, for 96-10 Machine.....
12449	----	Throat Plate, small needle hole, for 12389 and 12457, for 96-10 Machine.....

Genuine Singer Needles should be used in Singer Machines.
These Needles and their Containers are marked with the Company's Trade Mark "SIMANCO." 1

Needles in Containers marked "For Singer Machines" are not Singer made needles. 2

NUMERICAL
LIST
OF PARTS

NUMERICAL LIST OF PARTS

No.	Plate	Name
76D	5875	Lifting Lever Connecting Rod Joint Hinge Screw, for 52319 and 52320.....
116E	5875	Arm Screw (back).....
121E	7691	" Shaft (horizontal) Gear Case Screw, for 52071.....
121E	7691	Rotating Hook Shaft Gear Case Screw, for 52072.....
144D	5875	Arm Shaft Screw, for 96-3 Machine.....
144D	5875	" " (horizontal) Screw, for 96-10, 96-12 and 96-16 Machines.....
152F	2834	Bobbin Winder Stop Latch Finger Screw, for 60456.....
157J	7692	Feed Lifting Rock Shaft Crank Clamping Screw, for 12376 and 52434.....
157J	7692	Feed Rock Shaft Crank Clamping Screw, for 29633.....
158C	5943	Bed Frame Cushion Screw, for 20067.....
158E	5943	Feed Reverse Lever Hinge Screw Clamping Screw, for 52409.....
171D	5942	Bobbin Winder Pulley Set Screw, for 41585
178E	5875	Bell Crank Bracket Screw, for 52319 and 52320.....
180D	5875	Arm Top Cover Screw.....
180D	5875	Bobbin Winder Arm Top Cover Screw, for 41348.....
180D	5875	Bobbin Winder Tension Bracket Screw, for 41916.....
181D	5875	Rotating Hook Belt Guard Screw, for 96-3 Machine.....
185H	5942	Bobbin Winder Stop Latch Tripping Arm Clamping Screw, for 41588.....
190J	5875	Face Plate Screw.....
190J	5875	Presser Foot Screw.....
196J	5945	Finger Guard Clamping Screw, for 36820..
200F	2834	Bobbin Winder Pulley Set Screw, for 41342
207D	2834	" " Frame Spring Screw, for 60456.....
207E	5948	Needle Bar Connecting Stud Clamping Screw, for 24041.....
208E	5942	Thread Unwinder Thread Guide Rod Screw, for 225324.....
210D	5875	Balance Wheel Oil Cover Screw.....
211E	5943	Bed Frame Hinge Connection Cap Screw, for 19398.....
219D	5875	Arm Side Cap Screw.....
223C	5936	Slack Thread Regulator Set Screw, for 52338.....
226J	5900	Face Plate Thread Guard (lower) Screw, for 52052.....

No.	Plate	Name
226J	5900	Face Plate Thread Guard (upper) Screw, for 52052.....
229J	5948	Needle Bar Thread Guard Screw.....
248A	7691	Clamp Stop Motion Clamp Stop Screw, for 52405.....
256J	7694	Clamp Stop Motion Clamp Screw, for 52405.
286D	5875	Arm Side Cover Thumb Screw, for 96-12 and 96-16 Machines, obsolete, use 51224W.
307C	5875	Feed Lifting Rock Shaft Screw Center, for 96-3 Machine.....
307C	5875	Feed Rock Shaft Screw Center, for 96-3 Machine.....
313C	5875	Feed Bar Screw Center.....
356C	5875	Rock Shaft Knee Arm Hub Set Screw, for 2766.....
356C	5875	Rock Shaft Knee Plate Set Screw, for 2767
356C	5875	" " Lifting Bracket Hook Set Screw, for 6337.....
356C	5875	Rock Shaft Lifting Bracket Set Screw, for 6337.....
356C	5875	Rock Shaft Stop Dog Set Screw, for 2770..
375C	7695	Feed Connecting Link Hinge Screw.....
375C	7695	" Forked Connection Hinge Screw.....
375C	7695	" Lifting Rock Shaft Connecting Rod Hinge Screw.....
389D	5942	Spool Holder Base Screw, for 96-10 Machine.....
418E	2834	Bobbin Winder Tension Screw Stud, for 27303.....
432C	5898	Arm Shaft (upright) Bushing (lower) Set Screw, for 96-10, 96-12 and 96-16 Machines.....
435C	7691	Arm Shaft Flanged Bushing (front) Set Screw, for 96-3 Machine.....
435C	7691	Arm Shaft (horizontal) Flanged Bushing (front) Set Screw, for 96-10, 96-12 and 96-16 Machines.....
435C	7691	Thread Take-up Lever Link Hinge Pin Set Screw.....
446C	5942	Feed and Feed Lifting Eccentric Set Screw, for 20233.....
447C	5898	Rotating Hook Shaft Bushing (back) Set Screw, for 96-3 Machine.....
448C	5875	Arm Shaft Flanged Bushing (back) Set Screw, for 96-3 Machine.....
448C	5875	Arm Shaft (horizontal) Flanged Bushing (back) Set Screw, for 96-10, 96-12 and 96-16 Machines.....
448C	5875	Balance Wheel Set Screw, for 52005 and 52081.....
448C	5875	Feed and Feed Lifting Eccentric Set Screw, for 52406.....

No.	Plate	Name
448C	5875	Lifting Lever Pin Set Screw, for 12237..
448C	5875	Thread Take-up Spring Regulator Set Screw.....
453C	5936	Presser Bar Guide Bracket Set Screw, for 52338.....
457C	5942	Bobbin Winder Frame Hinge Pin Set Screw, for 41583.....
457C	5942	Bobbin Winder Stop Latch Hinge Stud Set Screw, for 41913.....
460C	7691	Bobbin Winder Tension Stud Set Screw, for 41591.....
460C	7691	Thread Retainer Set Screw.....
591F	5869	Rotating Hook Bobbin Case Tension Regulating Screw, for 40395 and 52481..
592E	5869	Rotating Hook Bobbin Case Latch Stop Screw, for 40395 and 52473.....
665J	5892	Presser Foot Spring Guide Screw, for 36465.....
698J	5875	Pressure Regulating Thumb Screw.....
689C	5836	Presser Bar Lifter Screw.....
691F	5875	Throat Plate Screw.....
704J	5869	Rotating Hook Bobbin Case Holder Position Bracket Screw.....
725J	5875	Bed Slide Spring Screw, for 12432.....
732D	5875	Guide Thumb Screw, for 96-10 Machine....
766D	5875	Lifting Lever Link Hinge Screw, for 52319 and 52320.....
775E	5948	Needle Bar Connecting Link Cap Screw....
794E	5948	" " " " Adjusting Screw, for 24040.....
802D	5875	Lifting Lever Hinge Screw, for 52319 and 52320.....
808F	5948	Needle Clamp Screw, obsolete, use 51460F..
818D	5897	Feed Regulator Thumb Screw, for 96-3 and 96-10 Machines.....
854E	5942	Arm Screw (front).....
853C	5875	Needle Bar Crank Set Screw, for 24052 and 52436, obsolete.....
880E	7697	Bobbin Winder Screw, for 41915.....
966E	7691	Feed Lifting Rock Shaft Connecting Rod Cap Screw, for 12430 and 127156.....
1036C	5948	Arm Shaft (horizontal) Gear Set Screw, for 52060.....
1036C	5948	Thread Take-up Crank Set Screw, for 24052 52436 and 127222.....
1037C	5948	Thread Take-up Crank Position Screw, for 24052, 52436 and 127222.....
1053E	5869	Rotating Hook Thread Guard Screw, for 52076 and 52123.....
1065C	5875	Needle Bar Crank Position Screw, for 24052, 52436 and 127222.....
1128E	7695	Feed Regulator Hinge Screw.....

No.	Plate	Name
1133E	5948	Needle Bar Bushing (lower) Set Screw...
1133E	5948	" " " (upper) Set Screw...
1143C	7697	Rotating Hook Shaft Bushing (back) Set Screw, for 96-10, 96-12 and 96-16 Machines.....
1147C	7698	Rotating Hook Belt Pulley (lower) Set Screw, for 52048.....
1148C	5898	Rotating Hook Shaft Bushing (front) Set Screw, for 96-10, 96-12 and 96-16 Machines.....
1149C	5875	Arm Shaft (upright) Bushing (upper) Set Screw, for 96-10, 96-12 and 96-16 Machines.....
1253C	5869	Arm Shaft (upright) Gear (lower) Set Screw, for 56013.....
1253C	5869	Arm Shaft (upright) Gear (upper) Set Screw, for 56101.....
1253C	5869	Rotating Hook Set Screw, for 52076 and 52121.....
1253C	5869	Rotating Hook Shaft Gear Set Screw, for 56013.....
1362C	5942	Rotating Hook Belt Pulley (upper) Set Screw, for 52050.....
1367E	5869	Rotating Hook Section Screw, for 52076, 52089, 52440 and 127060.....
1380E	5869	Rotating Hook Bobbin Case Tension Spring Screw, for 40395 and 52481..
1429D	2834	Bobbin Winder Frame Hinge Screw, for 60456.....
1430D	2834	Bobbin Winder Stop Latch Hinge Screw, for 60456.....
1430D	2834	Bobbin Winder Stop Latch Lever Hinge Screw, for 60456.....
1513J	5942	Feed Lifting Rock Shaft Screw Center Nut.....
1513J	5942	Feed Rock Shaft Screw Center Nut.....
1518J	7695	" Connecting Link Hinge Screw Nut...
1518J	7695	" Forked Connection Hinge Screw Nut.
1518J	7695	" Lifting Rock Shaft Connecting Rod Hinge Screw Nut.....
1519J	5942	Feed Bar Screw Center Nut.....
1520J	5936	Presser Bar Lifter Screw Nut.....
1521J	5942	Lifting Lever Connecting Rod Lock Nut, for 52319 and 52320.....
1550H	2834	Bobbin Winder Stop Latch Hinge Screw Nut, for 60456.....
1560C	7692	Tension Regulating Thumb Nut, for 52098.
1562J	2834	Bobbin Winder Tension Regulating Thumb Nut, for 27308.....
1811	7695	Feed Reverse Lever Roller and Stud, for 52409, obsolete, use 51846.....
1813	7692	Feed Lifting Rock Shaft Crank Roller and Stud, for 12376 and 52434.....

No.	Plate	Name
2020	7694	Clamp Stop Motion Clamp Washer, for 52405
2022	7692	" " " Flanged Bushing Pin, for 96-12 Machine.....
2102	7692	Tension Disc, for 52397.....
2103	7692	" Spring, for 52397.....
2106	2834	Bobbin Winder Tension Thread Guide, for 27308.....
2455	2834	Bobbin Winder Tension Disc, for 27308 and 41592.....
2763	819	Rock Shaft, for 2777, 4880 and 12250,.... Nos. 2765 to 2767, for 2768
2765	5235	Rock Shaft Knee Arm.....
2766	5235	" " " " Hub with 356C.....
2767	5235	" " " " Plate with 356C.....
2768	----	Rock Shaft Knee Arm complete for 2777 and 12250, Nos. 2765 to 2767.....
2770	819	Rock Shaft Stop Dog with 356C, for 2777, 4880 and 12250.....
2777	5235	Rock Shaft complete for 52320, Nos. 2763, 2768, 2770, 2778, 6337 and two 12242, obsolete.....
2778	5235	Rock Shaft Lifting Bracket Hook, for 2777 and 12250.....
2974	5869	Rotating Hook Bobbin Case Latch Lever Fulcrum Pin, for 40393.....
2975	5869	Rotating Hook Bobbin Case Latch Spring, for 40395 and 52473.....
3033	7695	Feed Connecting Link.....
3039	7698	" Regulator, for 96-3 Machine.....
4307	5894	Bed Slide Spring, for 12432.....
4448	7692	Arm Shaft (upright) Oil Tube (lower) for 52399, obsolete.....
4448	7692	Arm Shaft (upright) Oil Tube (upper) for 52399, obsolete.....
4879	7694	Chain Connecting Link, for 4885.....
4680	819	Rock Shaft complete for 52319, Nos. 2763, 2770, 7125, 12243 and two each 6337 and 12242.....
		Nos. 4881 to 4884, for 4885
4881	819	Treadle.....
4882	7694	" Shaft.....
4883	7694	" Spring.....
4884	819	" Stand.....
4885	819	Treadle complete for 52319, Nos. 4879, 4881 to 4884 and two wood screws 1 in. No. 16.....
5596	7694	Bell Crank, for 56848.....
5598	7694	Bell Crank complete for 52319 and 52320, Nos. 5735 and 56848.....
5599	7694	Bell Crank Bracket, for 56848.....
5601	5943	" " Hinge Pin, for 56848.....
5670	----	Chain, length 26 in. to 35 in., with 56864 and 56865, for 52319.....

No.	Plate	Name
5735	5943	Bell Crank Spring, for 5598.....
5990	7697	Presser Bar Lifter, for 96-16 Machine..
6267	5900	Hemmer Folder.....
6337	819	Rock Shaft Lifting Bracket with two 356C, for 2777, 4880 and 12250.....
7125	819	Rock Shaft Lifting Bracket Hook, for 4880.....
7298	5900	Presser Foot Hinge Pin, for 19336, 20270 and 52439.....
7539	----	Rock Shaft Hanger with two wood screws 1 in. No. 10, for 12250.....
7958	7697	Bobbin Winder Stop Latch Stop Pin, for 60845.....
8879	5936	Arm Spool Pin Washer (cloth).....
8879	5936	Bobbin Winder Arm Top Cover Spool Pin Washer (cloth) for 41348.....
8879	5936	Bobbin Winder Tension Bracket Spool Pin Washer (cloth) for 41916.....
8908	5901	Wrench for 1519 and 1520 (Accessories).
8909	5901	" " 1513 and 1518 (Accessories).
9331	2834	Bobbin Winder Washer, for 41347.....
10141	2834	" " Tension Spring, for 27308.
11119	5900	Arm Oil Tube with 52045, for oiling 52022.....
11167	5896	Presser Bar Spring.....
11170	5936	" " " Washer.....
11204	5943	Thread Take-up Lever Link Hinge Pin....
11241	2833	Bobbin Winder Spool Washer (cloth) for 27308.....
Nos. 12142 to 12144, for 96-10 Machine		
12142	5949	Presser Foot, for 12370.....
12143	5864	" " " 20106.....
12144	5864	" " " 20117, 20138, 20147, 20151, 20158 and 20162.....
12193	5894	Arm Side Cover.....
12237	5946	Lifting Lever with 448C, for 52319 and 52320.....
12240	5936	Lifting Lever Pin, for 52319 and 52320..
12241	5936	" " Link, for 52319 and 52320.
12242	819	Rock Shaft Hanger with two wood screws 1 in. No. 10, for 2777 and 4880.....
12243	819	Rock Shaft Lifting Bracket Hook, for 4880.....
12250	----	Rock Shaft complete for 52320, Nos. 2763, 2768, 2778, 6337 and two each 2770 and 7539.....
Nos. 12258 to 12261, for 96-10 Machine		
12258	5949	Presser Foot (wide) for 20106.....
12259	5949	" " for 12425.....
12260	5864	" " " 12450, 20147 and 20348.
12261	5864	" " " 12481.....
12327	5936	" Bar Lifting and Releasing Lever Bracket.....

No.	Plate	Name
12326	5936	Tension Releasing Lever Spring.....
12335	5949	Presser Foot (narrow) for 20106, for 96-10 Machine.....
12361	5943	Machine Hinge Connection, for 44140.....
12369	5932	Feed Dog, for cloth, 12 teeth (12 teeth to the inch) for 96-10 Machine, obso- lete.....
12370	778	Feed Dog, for cloth, 15 teeth (16 teeth to the inch) for 96-10 Machine.....
12376	7692	Feed Lifting Rock Shaft Crank 52271 with 157J and 1813, for 44126 and 52385..
12379	7690	Feed Rock Shaft, for 20333.....
12391	5896	Presser Bar (hollow).....
12398	5936	Tension Releasing Lever Hinge Pin.....
12403	5900	Arm Spool Pin and Thread Eyelet, for 52043.....
12403	5900	Bobbin Winder Arm Top Cover Spool Pin and Thread Eyelet, for 52043.....
12403	5900	Bobbin Winder Tension Bracket Spool Pin and Thread Eyelet, for 41592.....
12405	5943	Machine Rest, felt (Accessories).....
12411	5932	Throat Plate, large needle hole, for 12369 and 12457, for 96-10 Machine, obso- lete.....
12412	778	Throat Plate, large needle hole, for 12370 for 96-10 Machine.....
12416	5936	Lifting Lever Connecting Rod Joint, for 52319 and 52320.....
12425	5932	Feed Dog, for cloth, for 96-10 Machine....
12426	5932	Throat Plate, large needle hole, for 12425 for 96-10 Machine.....
12430	5896	Feed Lifting Rock Shaft Connecting Rod with two 966E, obsolete, use 127156..
12431	----	Bed Slide, for 12432.....
12432	5894	Bed Slide complete, Nos. 4307, 12431 and two 725J.....
12449	----	Throat Plate, small needle hole, for 12369 and 12457, for 96-10 Machine, obso- lete.....
12450	5933	Feed Dog, for cloth, 11 teeth (18 teeth to the inch) for 96-10 Machine.....
12451	----	Throat Plate, small needle hole, for 12450 and 20348, for 96-10 Machine.....
12454	5900	Arm Oil Tube with 132590, for oiling 52024, for 96-3, 96-12 and 96-16 Ma- chines.....
12457	5932	Feed Dog, for cloth, 16 teeth (16 teeth to the inch) for 96-10 Machine, obso- lete.....
12464	5933	Throat Plate, large needle hole, for 12450 and 20348, for 96-10 Machine.....
12466	----	Throat Plate, small needle hole, for 12425 for 96-10 Machine.....

No.	Plate	Name
12474	5949	Presser Foot, for 20138 and 20162, for 96-10 Machine.....
12480	5894	Arm Side Cap.....
12481	778	Feed Dog, for general work, 18 teeth (16 teeth to the inch) for 96-10 Machine.....
12482	----	Throat Plate, large needle hole, for 12481 for 96-10 Machine.....
12483	778	Throat Plate, small needle hole, for 12481 for 96-10 Machine.....
14010	5943	Bed Frame Hinge Plate Rivet, for 20067...
15404	----	Trade Mark.....
15405	----	" " Rivet.....
16532	5943	Arm Dowel Pin.....
16555	5943	Bed Frame Hinge Plate, for 20067.....
19219	5943	" " Cushion (leather) for 20067...
19220	5943	" " " Spring, for 20067.....
19223	----	Presser Foot Shank, for 20311.....
19226	5943	Bed Frame Hinge Connection, for 19398...
19334	----	Presser Foot Plate, for 19336.....
19335	----	" " Shank, for 19336.....
19336	5938	Presser Foot (hinged) complete for 12370 for 96-10 Machine, Nos. 7298, 19334 and 19335.....
19397	5943	Bed Frame Hinge Connection Cap, for 19398
19398	----	" " " " 19226 with 211E and 19397, for 20067.....
19405	----	Throat Plate, small needle hole, for 20117
19409	----	" " large needle hole, for 20138 and 20162, for 96-10 Machine.....
19410	1263	Throat Plate, small needle hole, for 20138 and 20162, for 96-10 Machine.....
19412	5933	Throat Plate, large needle hole, for 20147 for 96-10 Machine.....
19413	----	Throat Plate, small needle hole, for 20147 for 96-10 Machine.....
19415	1262	Throat Plate, large needle hole, for 20151 for 96-10 Machine.....
19416	----	Throat Plate, small needle hole, for 20151 for 96-10 Machine.....
19418	1262	Throat Plate, large needle hole, for 20158
19419	----	" " small needle hole, for 20158
19497	5933	" " large needle hole, for 20117
20021	5235	Drip Pan with four 1 in. wire nails, obsolete, use 44212.....
20067	819	Bed Frame with two each 16555, 19398, four each 19219, 19220, six each 14010, wood screws 1 1/4 in. No. 12 and eight 158C.....
20106	1259	Feed Dog, for cloth, for 96-10 Machine....
20107	1259	Throat Plate, small needle hole, for 20106 for 96-10 Machine.....

No.	Plate	Name
20117	5933	Feed Dog, for shirt work, beveled for hammer, 18 teeth (16 teeth to the inch) for 96-10 Machine.....
20119	1259	Feed Dog, for heavy work on duck overalls etc., for 96-10 Machine.....
20120	1259	Throat Plate, large oblong needle hole, for 20119, for 96-10 Machine.....
20138	1263	Feed Dog, for shirt work, beveled for hammer, 13 teeth (12 teeth to the inch) for 96-10 Machine.....
20147	5933	Feed Dog, 12 teeth (14 teeth to the inch) for 96-10 Machine.....
20151	1262	Feed Dog, for shirt work, beveled for hammer, 13 teeth (14 teeth to the inch) for 96-10 Machine.....
20158	1262	Feed Dog, for shirt work, 17 teeth (16 teeth to the inch) for 36162, 36434, 120898 and 120911, for 96-10 Machine
20162	1263	Feed Dog, for shirt work, beveled for hammer, 17 teeth (18 teeth to the inch) for 96-10 Machine.....
20187	----	Throat Plate, small oblong needle hole, for 20119, for 96-10 Machine.....
20268	----	Presser Foot Plate, for 20270.....
20269	----	" " Shank, for 20270.....
20270	5938	Presser Foot (hinged) complete for 20106 for 96-10 Machine, Nos. 7298, 20268 and 20269.....
20283	5947	Feed and Feed Lifting Eccentric with 446C, for 96-3 and 96-10 Machines...
20284	5947	Feed Forked Connection, for 96-3 and 96-10 Machines.....
20310	----	Presser Foot Plate, for 20311.....
20311	5949	Presser Foot (hinged) complete for 20117 20138, 20147, 20151, 20158 and 20162, for 96-10 Machine, Nos. 19223, 20310 and 62527.....
20315	----	Throat Plate, large needle hole, for 20106 for 96-10 Machine.....
20333	----	Feed Rock Shaft complete, for 96-3 Machine, Nos. 12379 and 29633.....
20342	5949	Presser Foot, for 12450 and 20348, for 96-10 Machine.....
20343	5949	Presser Foot with guide on bottom to the right of needle hole, for 12450 and 20348, for 96-10 Machine.....
20344	----	Presser Foot Plate, for 20348.....
20345	----	" " Shank, for 20348.....
20346	5949	Presser Foot (spring hinged) complete for 20117, 20138, 20147, 20151, 20158 and 20162, for 96-10 Machine, Nos. 20344, 20345, 26231 and 62527.....

No.	Plate	Name
20348	5933	Feed Dog, for chiffon, 22 teeth (36 teeth to the inch) for 96-10 Machine.....
20458	5949	Presser Foot, for 44136, for 96-10 Machine
24036	5896	Feed and Feed Lifting Eccentric Sleeve, obsolete, use 127152.....
24040	5948	Needle Bar Connecting Link with 794E....
24041	5948	" " " Stud with 207E....
24052	7694	" " Crank with 1036C, 1037C and 1065C, for 96-3, 96-10 and 96-12 Machines.....
24131	5900	Arm Oil Tube with 52045, for oiling 127152.....
24131	5900	Arm Oil Tube with 52045, for oiling 127156, for 52043.....
24131	5900	Bobbin Winder Arm Top Cover Oil Tube with 52045, for 52043.....
24131	5900	Bobbin Winder Tension Bracket Oil Tube with 52045, for 41592.....
24297	5896	Balance Wheel Oil Cover, for 96-3 Machine
24544	----	Presser Foot Plate, for 24983.....
24982	----	" " Shank, for 24983.....
24983	5867	Presser Foot (spring hinged) complete, for 12425 and 20119, for 96-10 Machine, Nos. 24544, 24982, 26231 and 62527.....
25446	5900	Bobbin Winder Screw Washer, for 41915....
25866	6449	Guide, for 96-10, 96-12 and 96-16 Machines
25878	6449	" " 96-3 Machine.....
25888	5900	Hemmer Tongue.....
26026	5901	Screw Driver, large (Accessories).....
26231	5900	Presser Foot Spring, for 20346, 24983, 52427 and 52439.....
26485	5901	Screw Driver, small (Accessories).....
26603	7696	Feed Dog, for 96-12 Machine.....
26605	7696	Throat Plate, large needle hole, for 26603 28360 and 120001, for 96-12 and 96-16 Machines.....
26606	----	Throat Plate, small needle hole, for 26603 28360 and 120001, for 96-12 and 96-16 Machines.....
27306	2834	Bobbin Winder Spool Pin, for 27308.....
27307	2833	" " " Stand, for 27308....
27308	2833	Bobbin Winder Spool Stand complete for 41348, Nos. 418E, 1562J, 2106, 10141, 11241, 27306, 27307 and two each 2455 and wood screws 1 in. No. 10.....
27739	----	Thread Unwinder Thread Cone (wood) for large cones, for 225258.....
28360	7696	Feed Dog (15 conical teeth) for 96-12 Machine.....
29532	5948	Needle Bar Oil Cup, for 52305 and 52435..
29534	7698	Presser Foot, for 96-3 Machine.....

No.	Plate	Name
29633	7692	Feed Rock Shaft Crank with 157J, for 20333 and 52387.....
32572	7692	Tension Releasing Disc, for 52397.....
32574	7692	" " Pin, for 52397.....
34105	5902	Bobbin Winder Frame Hinge Pin, for 60845.
35682	----	Hemmer (foot) 1/8 in. hem, with guide on bottom to the right of needle hole.
35710	1252	Hemmer (foot) 3/32 in. hem, with guide on bottom to the right of needle hole.
35711	1252	Feed Dog, for 35682, 35710, 35997, 36072, 36309 and 36524.....
35712	1252	Throat Plate, small needle hole, for 35711
35997	----	Hemmer (foot) 3/16 in. hem, with guide on bottom to the right of needle hole.
36072	----	Hemmer (foot) 1/4 in. hem, with guide on bottom to the right of needle hole.
36118	----	Hemmer (foot) 3/32 in. hem, obsolete, use 120938.....
36119	5881	Hemmer (foot) 1/8 in. hem, obsolete, use 120803.....
36120	----	Hemmer (foot) 5/32 in. hem, obsolete, use 120804.....
36121	----	Hemmer (foot) 3/16 in. hem, obsolete, use 120805.....
36122	----	Hemmer (foot) 7/32 in. hem.....
36162	----	" " 3/32 in. hem, for China silk, etc.....
36309	----	Hemmer (foot) 7/32 in. hem, with guide on bottom to the right of needle hole.
36413	----	Hemmer (foot) plain bottom, 1/16 in. hem.
36414	----	" " " " 3/32 in. hem.
36415	5881	" " " " 1/8 in. hem, obsolete, use 120803.....
36416	----	Hemmer (foot) plain bottom, 3/16 in. hem.
36432	5861	" " 1/8 in. hem, for China silk, etc., obsolete, use 120898.....
36433	----	Hemmer (foot) 5/32 in. hem, for China silk etc., obsolete, use 120911.....
36434	----	Hemmer (foot) 3/16 in. hem, for China silk etc.....
36464	5892	Presser Foot Spring Guide, for 36465....
36465	5892	" " (right hand, spring guide) with 665J and 36464, for 1/32 in. to 5/16 in. gauge.....
36471	5881	Hemmer (foot) plain bottom, 1/8 in. hem, slotted for lace, obsolete, use 120837.....
36480	----	Hemmer (foot) plain bottom, 5/32 in. hem.
36524	----	" " 5/32 in. hem, with guide on bottom to the right of needle hole.
36574	5945	Presser Foot, for 36575.....
36575	5945	" " 36574 with 36576 and two 50202J.....

No.	Plate	Name
36576	5945	Presser Foot Finger Guard, for 36575....
36749	----	Henmer (foot) 1/4 in. hem, obsolete, use 120806.....
	Nos.	36818 to 36820, for 36821
36818	5945	Finger Guard.....
36819	5945	" " Friction Washer.....
36820	5945	" " Holder with 196J.....
36821	5945	Finger Guard complete, Nos. 36818 to 36820 and 50316J.....
40258	5935	Rotating Hook Belt, for 96-3 Machine....
40263	7698	" " " Pulley (upper) Stud, for 52050.....
40264	5869	Rotating Hook Bobbin.....
40274	5869	" " Section, for 52076, 52089 and 127060.....
40392	5869	Rotating Hook Bobbin Case Latch, for 40393.....
40393	----	Rotating Hook Bobbin Case Hinge, for 40395 and 52473, Nos. 2974, 40392 and 125320.....
40394	5869	Rotating Hook Bobbin Case Tension Spring for 40395 and 52481.....
40395	5869	Rotating Hook Bobbin Case complete for 40408 and 52442, Nos. 591F, 592E, 1380E 2975, 40393, 40394 and 40431, obsolete use 52473.....
40396	5869	Rotating Hook Bobbin Case Holder, for 40408, obsolete.....
40398	5869	Rotating Hook Thread Guard, for 52076, ob- solete.....
40408	----	Rotating Hook Bobbin Case 40395 with 40396, for 52091, obsolete.....
40409	5869	Rotating Hook Bobbin Case Latch Lever, for 40393, obsolete, use 125320....
40431	----	Rotating Hook Bobbin Case, for 40395, ob- solete, use 52472.....
41339	2833	Bobbin Winder Base, for 60456.....
41340	2833	" " Frame, for 60456.....
41341	2833	" " " Spring, for 60456....
41342	2833	" " Pulley with 200F, for 60456
41343	2834	" " Spindle, for 60456.....
41344	2834	" " Stop Latch, for 60456.....
41345	2834	" " " " Finger, for 60456.....
41346	2834	Bobbin Winder Stop Latch Lever, for 60456.....
41347	2833	Bobbin Winder for 41348, Nos. 60456 and two each 9331 and wood screws 1 in. No. 10 R.H.B.....
41348	----	Bobbin Winder (swinging automatic, right hand) complete, Nos. 27308 and 41347.
41583	5902	Bobbin Winder Frame with 457C, for 60845.

No.	Plate	Name
41585	5902	Bobbin Winder Pulley with 171D, for 60845
41586	5902	" " Spindle, for 60845.....
41587	5902	" " Stop Latch, for 60845.....
41588	5902	" " " " Tripping Arm with 185H, for 60845.....
41591	5902	Bobbin Winder Tension Bracket with 460C, for 41592.....
41592	5902	Bobbin Winder Tension Bracket complete for 41916, Nos. 12403, 24131, 41591, 41593 to 41595 and two 2455.....
	Nos.	41593 to 41595, for 41592
41593	5936	Bobbin Winder Tension Spring.....
41594	5936	" " " Stud.....
41595	5936	" " " Thread Guide.....
41913	5902	" " Bracket with 457C, for 60845.....
41914	5902	Bobbin Winder Frame Spring, for 60845....
41915	5902	" " 60845 with 880E and 25446, for 41916.....
41916	----	Bobbin Winder (swinging automatic, left hand) complete, Nos. 41592 and 41915.
42614	5902	Bobbin Winder Stop Latch Hinge Stud, for 60845.....
43921	5896	Arm Shaft Flanged Bushing (back) for 96-3 Machine.....
43944	5936	Tension Releasing Lever, for 96-3, 96-10 and 96-12 Machines.....
44125	7690	Feed Lifting Rock Shaft, for 44126.....
44126	----	Feed Lifting Rock Shaft complete, for 96-3 Machine, Nos. 12376 and 44125.
44136	5805	Feed Dog, for 96-3 and 96-10 Machines...
44137	5805	Throat Plate, large needle hole, for 44136 for 96-3 and 96-10 Machines.....
44138	----	Throat Plate, small needle hole, for 44136 for 96-10 Machine.....
44139	5943	Machine Hinge Plate, for 44140.....
44140	----	Machine Hinge complete, Nos. 12361, 44139 and wood screw 1 1/4 in. No. 14 (Ac- cessories).....
44212	----	Drip Pan with four 1 in. wire nails.....
50053D	7698	Arm Side Cover Thumb Screw, for 96-3 and 96-10 Machines.....
50083C	5897	Feed Connecting Link Hinge Stud Set Screw, for 52074 and 52408.....
50117E	5875	Feed Dog Screw.....
50145E	7698	Rotating Hook Shaft Bushing (front) Position Screw, for 96-3 Machine...
50190D	7691	Face Plate Thumb Screw.....
50190D	7691	Guide Thumb Screw, for 96-3, 96-12 and 96-16 Machines.....
50191C	7691	Feed Lifting Rock Shaft Screw Center, for 96-10, 96-12 and 96-16 Machines.....

No.	Plate	Name
50191C	7691	Feed Rock Shaft Screw Center, for 96-10, 96-12 and 96-16 Machines.....
50193J	7695	Feed Regulating Stud Head Cap Screw, for 96-12 and 96-16 Machines.....
50200C	7695	Feed Connecting Link Hinge Stud Set Screw, obsolete, use 50083C.....
50202J	5945	Presser Foot Finger Guard Screw, for 36575.....
50234E	7691	Arm Shaft (horizontal) Gear Case Plug Screw, for 52071.....
50234E	7691	Rotating Hook Shaft Gear Case Plug Screw for 52072.....
50304C	7692	Tension Stud, for 52098.....
50305C	7692	" " Set Screw, for 52083.....
50311C	7691	Clamp Stop Motion Flanged Bushing Set Screw, for 52404.....
50316J	5945	Finger Guard Hinge Screw, for 36821.....
50338E	7695	Feed Regulating Stud, for 96-12 and 96-16 Machines.....
50339D	7695	Feed Reverse Lever Hinge Screw, for 96-12 and 96-16 Machines.....
51224W	----	Arm Side Cover Thumb Screw, for 96-12 and 96-16 Machines.....
51460F	----	Needle Clamp Screw, for 52307.....
51846	----	Feed Reverse Lever Roller and Stud, for 52409.....
52005	5893	Balance Wheel (power) light rim, 2 3/16 in. pulley, with two 448C.....
52011	5896	Feed Bar, for 96-3, 96-10 and 96-12 Machines, obsolete, use 52452.....
52014	5948	Needle Bar Bushing (upper) for 96-3, 96-10 and 96-12 Machines.....
52016	5936	Presser Bar Lifter, for 96-3, 96-10 and 96-12 Machines.....
52018	5869	Rotating Hook Bobbin Case Holder Position Bracket.....
52021	5948	Thread Take-up Crank, for 96-3, 96-10 and 96-12 Machines.....
		Nos. 52022 to 52024, for 52025
52022	5948	Thread Take-up Lever with 52130.....
52023	5948	" " " Hinge Pin.....
52024	5948	" " " Link.....
52025	----	Thread Take-up Lever complete, Nos. 52022 to 52024.....
52027	7692	Thread Guard (side of arm) for 96-3, 96-10 and 96-12 Machines.....
52028	7694	Lifting Lever Connecting Rod, for 52319 and 52320.....
52037	5935	Rotating Hook Belt Guard, for 96-3 Machine.....
52039	7698	Rotating Hook Shaft Bushing (front) for 96-3 Machine.....

No.	Plate	Name
52042	5896	Arm Top Cover, for 52043.....
52042	5896	Bobbin Winder Arm Top Cover, for 52043..
52043	5896	Arm Top Cover 52042 with 12403 and 24131
52043	5896	Bobbin Winder Arm Top Cover 52042 with 12403 and 24131, for 41348.....
52044	7698	Rotating Hook Shaft Bushing (back) for 96-3 Machine.....
52045	5898	Arm Oil Tube Packing (cotton) for 11119, 24131 and 52084.....
52045	5898	Bobbin Winder Tension Bracket Oil Tube Packing (cotton) for 24131.....
52045	5898	Rotating Hook Shaft Bushing (back) Packing (cotton).....
52045	5898	Rotating Hook Shaft Bushing (front) Packing (cotton).....
52046	5947	Spool Holder Base, for 52047.....
52047	5947	Spool Holder complete, for 96-10 Machine, Nos. 52046, 200079H and 204296.....
52048	5888	Rotating Hook Belt Pulley (lower) steel, with two 1147C and sixteen 52049, for 96-3 Machine.....
52049	5888	Rotating Hook Belt Pulley (lower) Stud for 52048.....
52050	5888	Rotating Hook Belt Pulley (upper) with 1362C and thirty 40263, for 96-3 Machine.....
52051	----	Face Plate, for 52052.....
52052	5894	Face Plate complete, Nos. 52051, 52053, 52170 and two 226J.....
52053	5900	Face Plate Thread Guard (lower) for 52052.....
52059	5894	Arm Shaft (horizontal) Flanged Bushing (back) for 96-10, 96-12 and 96-16 Machines, obsolete, use 52191.....
52060	5898	Arm Shaft (horizontal) Gear with two 1036C, for 96-10, 96-12 and 96-16 Machines.....
52062	5898	Arm Shaft (upright) for 96-10, 96-12 and 96-16 Machines.....
52063	5894	Balance Wheel Oil Cover, for 96-10, 96-12 and 96-16 Machines.....
52071	5894	Arm Shaft (horizontal) Gear Case (two pieces) with 121E and 50234E, for 96-10, 96-12 and 96-16 Machines.....
52072	5894	Rotating Hook Shaft Gear Case (two pieces) with 121E and 50234E, for 96-10, 96-12 and 96-16 Machines.....
52073	5897	Feed Connecting Link Hinge Stud, for 96-10, 96-12 and 96-16 Machines.....
52074	5897	Feed Regulator with 50083C, for 96-10 Machine.....

No.	Plate	Name
52076	5869	Rotating Hook with 40274,40398,two 1253C and three each 1053E and 1367E, obsolete, use 52089.....
52078	5894	Arm Shaft Flanged Bushing (front) for 96-3 Machine, obsolete, use 52196..
52078	5894	Arm Shaft (horizontal) Flanged Bushing (front) for 96-10,96-12 and 96-16 Machines,obsolete,use 52196.....
52081	5893	Balance Wheel (stand) heavy rim, 2 11/16 in. pulley, with two 448C,for 52382 for 96-10 and 96-12 Machines.....
52083	7692	Thread Take-up Spring Regulator with 50305C, for 52397.....
52084	5900	Arm Oil Tube with 52045, for oiling 24040 for 96-10 Machine.....
52089	5898	Rotating Hook 52123 with 40274 and three 1367E,for 52091 and 52124 (For Agents Only).....
52090	5898	Rotating Hook Thread Guard, for 52123...
*52091	----	" " 52089 with 40408,obsolete.
52098	----	Tension Stud 50304C with 1560C,for 52397
52121	----	Rotating Hook with three 1253C,for 52123
52123	----	" " 52121 with 52090 and four 1053E,for 52089,52440 and 127060...
52124	----	Rotating Hook 52089 with 52442,for 96-3, 96-10 and 96-12 Machines, obsolete, use 52478.....
52130	----	Thread Take-up Lever Thread Eyelet Bushing, for 52022.....
52170	----	Face Plate Thread Guard (upper) for 52052.....
52191	----	Arm Shaft (horizontal) Flanged Bushing (back) for 52192.....
52192	----	Arm Shaft (horizontal) Flanged Bushing (back) 52191 with 52193 and 52194, for 96-10, 96-12 and 96-16 Machine.
52193	----	Arm Shaft Flanged Bushing (front) Oil Pad (inside) for 52196.....
52193	----	Arm Shaft (horizontal) Flanged Bushing (back) Oil Pad (inside) braided cotton, for 52192.....
52193	----	Arm Shaft (horizontal) Flanged Bushing (front) Oil Pad (inside) for 52196.
52194	----	Arm Shaft (horizontal) Flanged Bushing (back) Oil Pad (outside) felt, for 52192.....
52195	----	Arm Shaft Flanged Bushing (front) for 52196.....
52195	----	Arm Shaft (horizontal) Flanged Bushing (front) for 52196.....
52196	----	Arm Shaft Flanged Bushing (front) 52195 with 52193 and 52198, for 96-3 Machine.....

No.	Plate	Name
52196	----	Arm Shaft (horizontal) Flanged Bushing (front) 52195 with 52193 and 52198, for 96-10,96-12 and 96-16 Machines.
52198	----	Arm Shaft Flanged Bushing (front) Oil Pad (outside) for 52196.....
52198	----	Arm Shaft (horizontal) Flanged Bushing (front) Oil Pad (outside) for 52196
*52271	----	Feed Lifting Rock Shaft Crank,for 12376.
52302	7690	Arm Shaft, for 96-3 Machine.....
*52303	----	Bed, for 96-3 Machine.....
52304	5948	Needle Bar (hollow) for 96-3 Machine....
52305	5948	" " Bushing (lower) with 29532, for 96-3,96-10 and 96-12 Machines..
52306	5948	Needle Bar Thread Guard.....
52307	5948	" Clamp with 51460F.....
52308	5935	Rotating Hook Shaft,for 96-3 Machine....
52319	----	Foot Lifter complete,Nos.76D,766D,802D, 1521J,4880,4885,5598,5670,12237, 12240,12241,12416,52028 and two 178E.....
52320	----	Knee Lifter complete (power table) Nos. 76D,766D,802D,1521J,5598,12237, 12240,12241,12250,12416,52028 and two 178E.....
52337	5936	Slack Thread Regulator.....
52338	5936	Presser Bar Guide Bracket with 223C and 453C.....
52359	5948	Feed Regulator Thumb Screw Stop,for 96-3 and 96-10 Machines.....
52378	5900	Thread Retaining Stud,for 52379,obsolete
52379	----	Thread Retainer complete,Nos.52378,52398 21C958 and 210993,obsolete.....
*52381	----	Arm with two 58015,for 96-10 Machine....
52382	5946	" Shaft (horizontal) for 96-10,96-12 and 96-16 Machines.....
*52383	----	Bed,for 96-10,96-12 and 96-16 Machines..
52384	5946	Feed Lifting Rock Shaft,for 52385 and 52433.....
52385	----	Feed Lifting Rock Shaft complete,for 96-10 and 96-12 Machines,Nos.12376 and 52384.....
52386	5946	Feed Rock Shaft,for 52387.....
52387	----	Feed Rock Shaft complete,for 96-10,96-12 and 96-16 Machines,Nos.29633 and 52386.....
52388	5946	Rotating Hook Shaft,for 96-10,96-12 and 96-16 Machines.....
52390	----	Presser Foot Shank, for 52427.....
*52392	----	Arm, for 96-3 Machine.....
52394	5948	Thread Take-up Spring, for 52397.....
52397	----	Tension complete,Nos.2103,32572,32574, 52083,52098,52394 and two 2102.....

No.	Plate	Name
52398	5900	Thread Retaining Spring, for 52379, obsolete.....
*52399	----	Arm with two 4448, for 96-12 and 96-16 Machines, obsolete, use 52432.....
52400	7690	Arm Shaft (horizontal) for 52405, for 96-12 Machine.....
52401	7694	Arm Shaft (horizontal) Flanged Bushing (back) for 52405, for 96-12 Machine.
*52402	----	Bed, for 96-12 and 96-16 Machines, obsolete, use 52383.....
*52403	----	Clamp Stop Motion Flanged Bushing, for 52404.....
52404	7694	Clamp Stop Motion Flanged Bushing 52403 with two 50311C, for 52405.....
52405	----	Clamp Stop Motion complete, for 96-12 Machine, Nos. 248A, 256J, 2020 and 52404.
Nos. 52406 to 52410, for 96-12 and 96-16 Machines		
52406	7694	Feed and Feed Lifting Eccentric with 448C.....
52407	7694	Feed Forked Connection.....
52408	7695	" Regulator with 50083C.....
52409	7695	" Reverse Lever with 158E and 51846..
52410	7695	" " " Hinge Screw Friction Washer.....
52426	----	Presser Foot Plate, for 52427.....
52427	7696	Presser Foot (spring hinged) complete for 96-12 Machine, Nos. 26231, 52390, 52426 and 62527.....
*52432	----	Arm with two 56015, for 96-12 and 96-16 Machines.....
Nos. 52433 to 52441, for 96-16 Machine		
52433	----	Feed Lifting Rock Shaft complete, Nos. 52384 and 52434.....
52434	7697	Feed Lifting Rock Shaft Crank with 157J and 1813, for 52433.....
52435	7697	Needle Bar Bushing (lower) with 29532...
52436	7694	" " Crank with 858C, 1036C, 1037C and 1065C, obsolete, use 127222.....
52437	----	Presser Foot Plate, for 52439.....
52438	----	" " Shank, for 52439.....
52439	7697	Presser Foot (spring hinged) complete, Nos. 7298, 26231, 52437 and 52438.....
52440	7697	Rotating Hook 52123 with 52444 and three 1367E, for 52480 (For Agents Only)..
*52441	----	Rotating Hook 52440 with 52442, obsolete use 52480.....
52442	----	Rotating Hook Bobbin Case 40395 with 52443, for 52124 and 52441, obsolete use 127099.....
52443	7697	Rotating Hook Bobbin Case Holder, for 52442, obsolete, use 127100.....
52444	7697	Rotating Hook Section, for 52440.....

No.	Plate	Name
52445	7697	Tension Releasing Lever, for 96-16 Machine.....
52446	7697	Thread Take-up Crank, for 96-16 Machine..
52448	7697	Needle Bar Bushing (upper) for 96-16 Machine.....
52452	7694	Feed Bar.....
52454	7698	Thread Retainer.....
52455	7698	Needle Bar (hollow) for 96-10, 96-12 and 96-16 Machines.....
52472	----	Rotating Hook Bobbin Case, for 52481....
52473	----	Rotating Hook Bobbin Case complete for 52478 and 127099, Nos. 592E, 2975, 40393 and 52481.....
*52475	----	Rotating Hook Bobbin Case Locating Plate for 127100.....
*52476	----	Rotating Hook Bobbin Case Locating Plate Rivet, for 127100.....
52478	----	Rotating Hook 127060 with 52473, for 96-3 96-10 and 96-12 Machines.....
52480	----	Rotating Hook 52440 with 127099.....
52481	----	" " Bobbin Case 52472 with 591F, 1380E and 40394, for 52473....
54897	5900	Arm Shaft (horizontal) Front Bearing Oil Cup, for 96-10, 96-12 and 96-16 Machines.....
56013	5898	Arm Shaft (upright) Gear (lower) with two 1253C, for 96-10, 96-12 and 96-16 Machines.....
56013	5898	Rotating Hook Shaft Gear with two 1253C, for 96-10, 96-12 and 96-16 Machines.
56015	5900	Arm Shaft (upright) Oil Tube (lower) for 52381 and 52432.....
56015	5900	Arm Shaft (upright) Oil Tube (upper) for 52381 and 52432.....
56017	7693	Balance Wheel, 2 1/4 in. pulley, for 52405, for 96-12 Machine.....
Nos. 56032 to 56035, for 96-12 and 96-16 Machines		
56032	7695	Feed Regulating Stud Head with 56033....
56033	7695	" " " " Stop Pin, for 56032.....
56034	7695	Feed Regulating Stud Lock Pin.....
56035	7695	" " " " " Spring...
56086	5900	Face Plate Thread Guard (upper) obsolete use 52170.....
56099	5898	Arm Shaft (upright) Bushing (lower) for 96-10, 96-12 and 96-16 Machines.....
56100	5898	Arm Shaft (upright) Bushing (upper) for 96-10, 96-12 and 96-16 Machines.....
56101	5898	Arm Shaft (upright) Gear (upper) with two 1253C, for 96-10, 96-12 and 96-16 Machines.....
56108	5898	Rotating Hook Shaft Bushing (back) for 96-10, 96-12 and 96-16 Machines.....

No.	Plate	Name
56107	5898	Rotating Hook Shaft Bushing (front) for 96-10, 96-12 and 96-16 Machines.....
56848	----	Bell Crank 5596 with 5599 and 5601, for 5598.....
56864	----	Chain Hook (large) for 5670.....
56885	----	" " (small) for 5670.....
60456	----	Bobbin Winder, Nos. 152F, 207D, 1429D, 1550H, 41339 to 41346 and three 1430D, for 41347.....
60845	----	Bobbin Winder, Nos. 7958, 34105, 41583, 41585 to 41588, 41913, 41914 and 42614, for 41915.....
62527	7698	Presser Foot Hinge Pin, for 20311, 20346, 24983 and 52427.....
120001	7696	Feed Dog (spiked teeth) for 96-12 and 96-16 Machines.....
120342	----	Oiler with 120343 (Accessories).....
120343	----	" Spout, 3 1/2 in. long, for 120342 (Accessories).....
120803	----	Hemmer (foot) 1/8 in. hem.....
120804	----	" " 5/32 in. hem.....
120805	----	" " 3/16 in. hem.....
120806	----	" " 1/4 in. hem.....
120837	----	" " plain bottom, 1/8 in. hem, slotted for lace.....
120898	----	Hemmer (foot) 1/16 in. to 1/8 in. hem, for China silk, etc.....
120911	----	Hemmer (foot) 5/32 in. to 1/4 in. hem, for China silk, etc.....
120938	----	Hemmer (foot) 3/32 in. hem.....
125320	----	Rotating Hook Bobbin Case Latch Lever, for 40393.....
127060	----	Rotating Hook 52123 with 40274, 127100 and three 1367E, for 52478.....
127099	----	Rotating Hook Bobbin Case 52473 with 127100, for 52480 (For Agents Only)
127100	----	Rotating Hook Bobbin Case Holder with 52475 and two 52476, for 127060 and 127099.....
127152	----	Feed and Feed Lifting Eccentric Sleeve..
127158	----	" Lifting Rock Shaft Connecting Rod with two 966E.....
127222	----	Needle Bar Crank with 1036C, 1037C and 1065C, for 96-16 Machine.....
132590	----	Arm Oil Tube Packing (wick) for 12454...
150203	----	Thread Unwinder Spool Rest Cushion (felt) for 225258.....
200079H	5942	Spool Holder Base Wire Hinge Screw, for 52047.....
200383C	----	Thread Unwinder Spool Rest Rod Set Screw for 202490.....
201018C	----	Thread Unwinder Spool Rest Set Screw, for 225257.....

No.	Plate	Name
201696J	----	Thread Unwinder Thread Guide Lock Nut, for 225258.....
202490	----	Thread Unwinder Spool Stand with 200383C for 225258.....
204296	5947	Spool Holder Base Wire, for 52047.....
210958	5900	Thread Retaining Collar, for 52379, obsolete.....
210993	5900	Thread Retaining Sleeve, for 52379, obsolete.....
225257	----	Thread Unwinder Spool Rest with 201018C, for 225258.....
225258	----	Thread Unwinder complete, for two spools or two large cones of thread, Nos. 201696J, 202490, 225257, 225324, 225326, 225388, two each 150203, 225391 and three wood screws 7/8 in. No. 12...
225322	----	Thread Unwinder Thread Guide Rod Washer, for 225324.....
225324	----	Thread Unwinder Thread Guide Rod with 208E and 225322, for 225258.....
225326	----	Thread Unwinder Thread Guide Position Cup, for 225258.....
225388	----	Thread Unwinder Spool Rest Rod, for 225258.....
225390	----	Thread Unwinder Thread Cone Holder, for inverted cones, for 225258.....
225391	----	Thread Unwinder Thread Guide, for 225258.

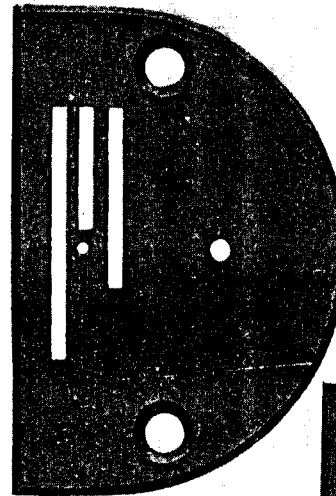
Genuine Singer Needles should be used
in Singer Machines.
These Needles and their Containers
are marked with the
Company's Trade Mark "SIMANCO." 1

Needles in Containers marked
"For Singer Machines"
are not Singer made needles. 2

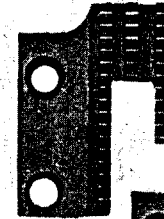
ILLUSTRATIONS
OF
PARTS

PLATE 778—FULL SIZE

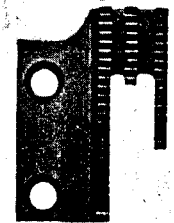
12483



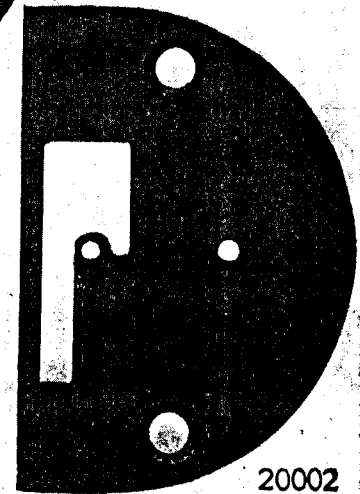
12481



43978



12412



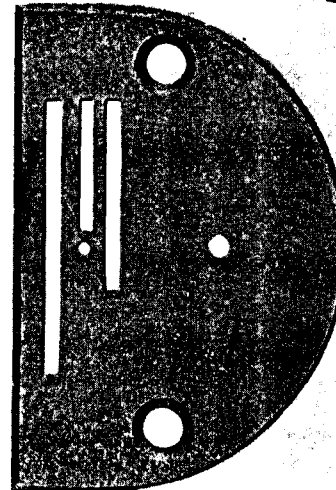
12370



43979



12442



20002

20304



12372



PLATE 819—ONE-FOURTH SIZE

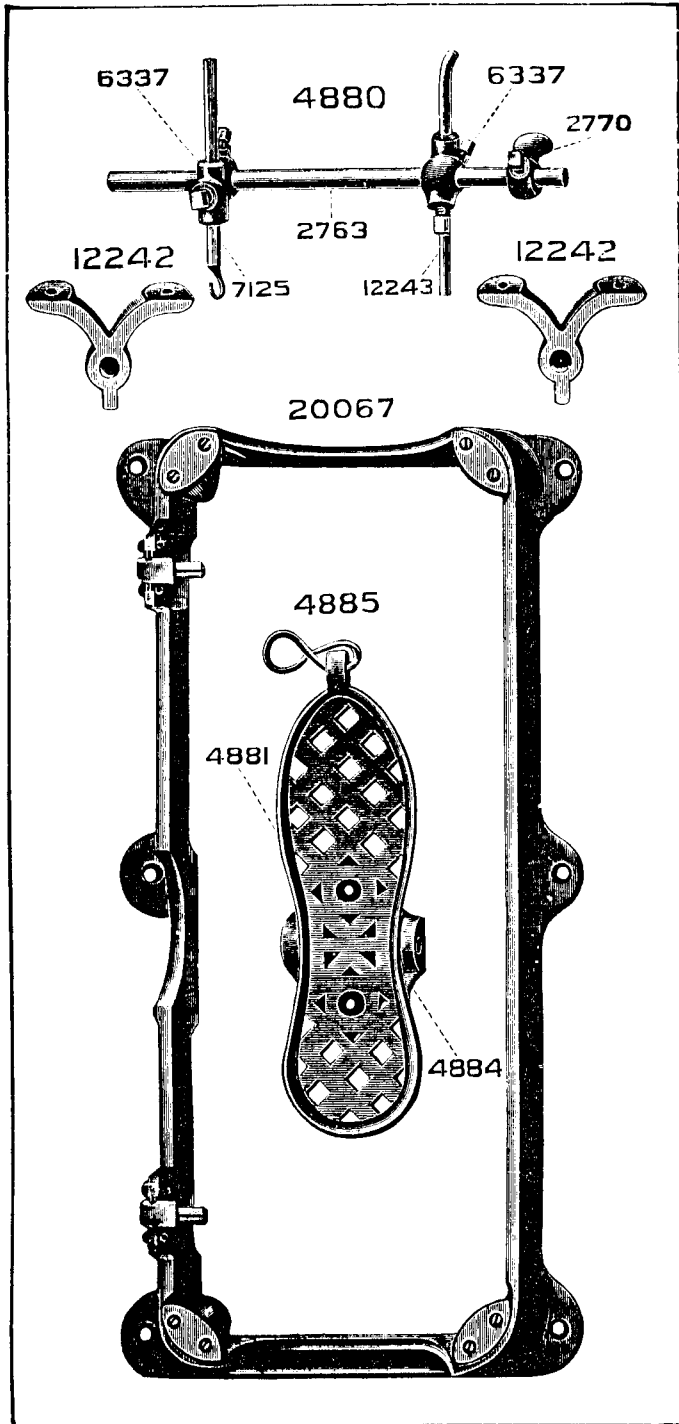


PLATE 1252—FULL SIZE

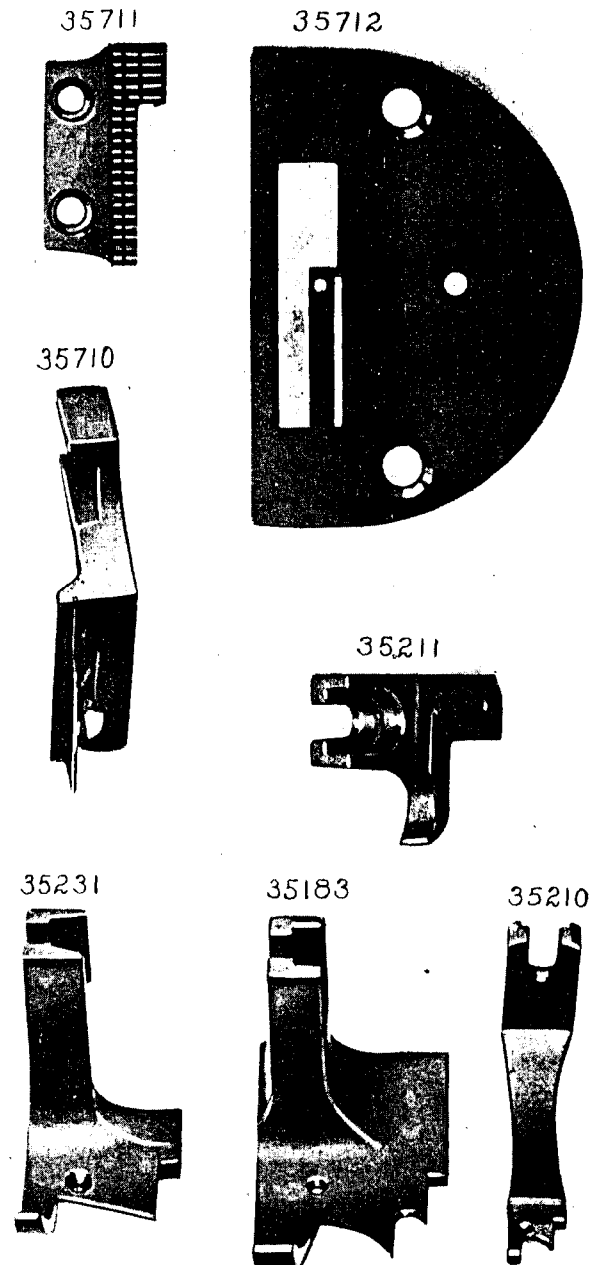


PLATE 1259—FULL SIZE

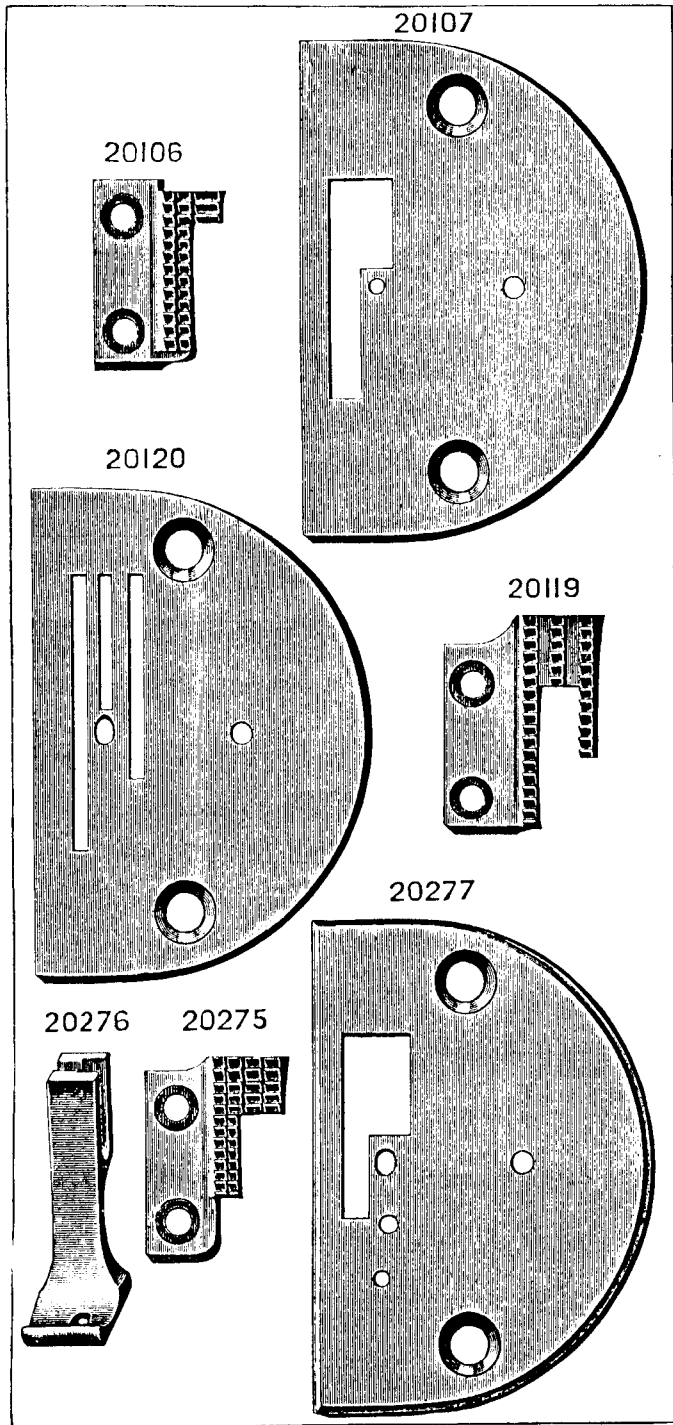


PLATE 1262—FULL SIZE

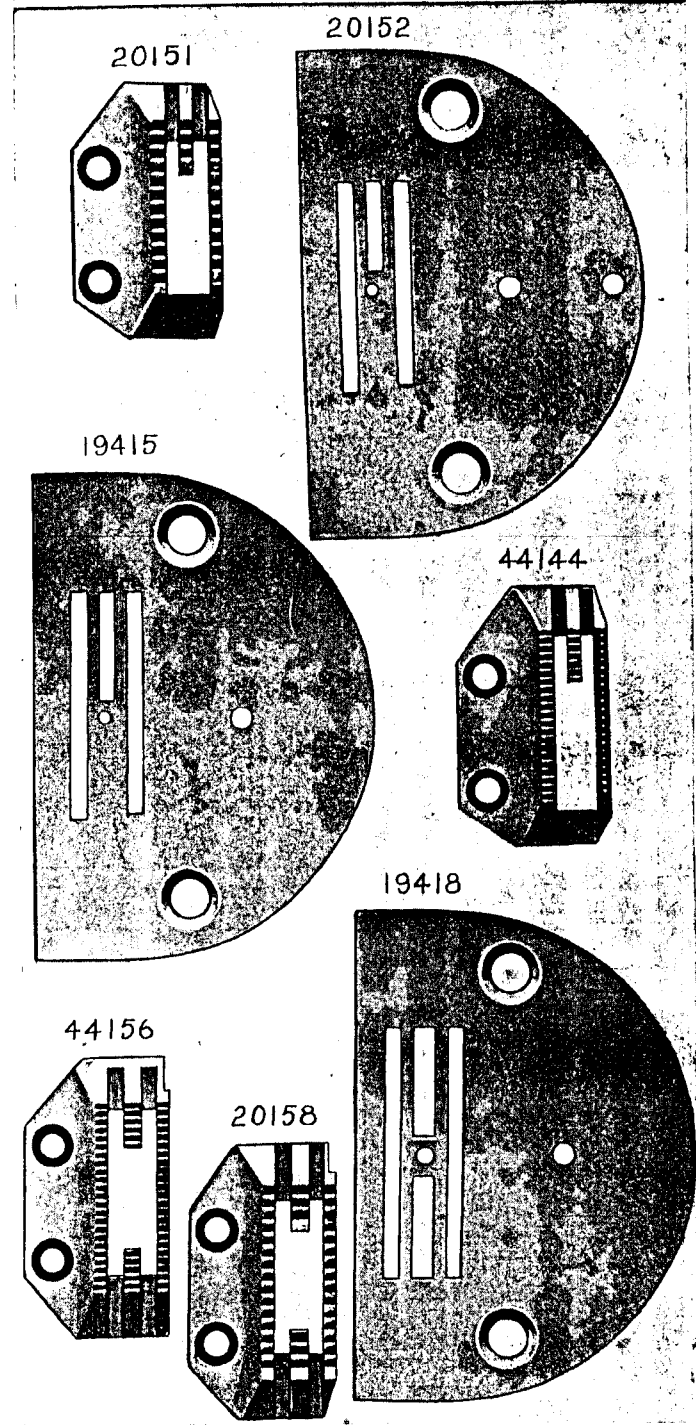


PLATE 1263—FULL SIZE

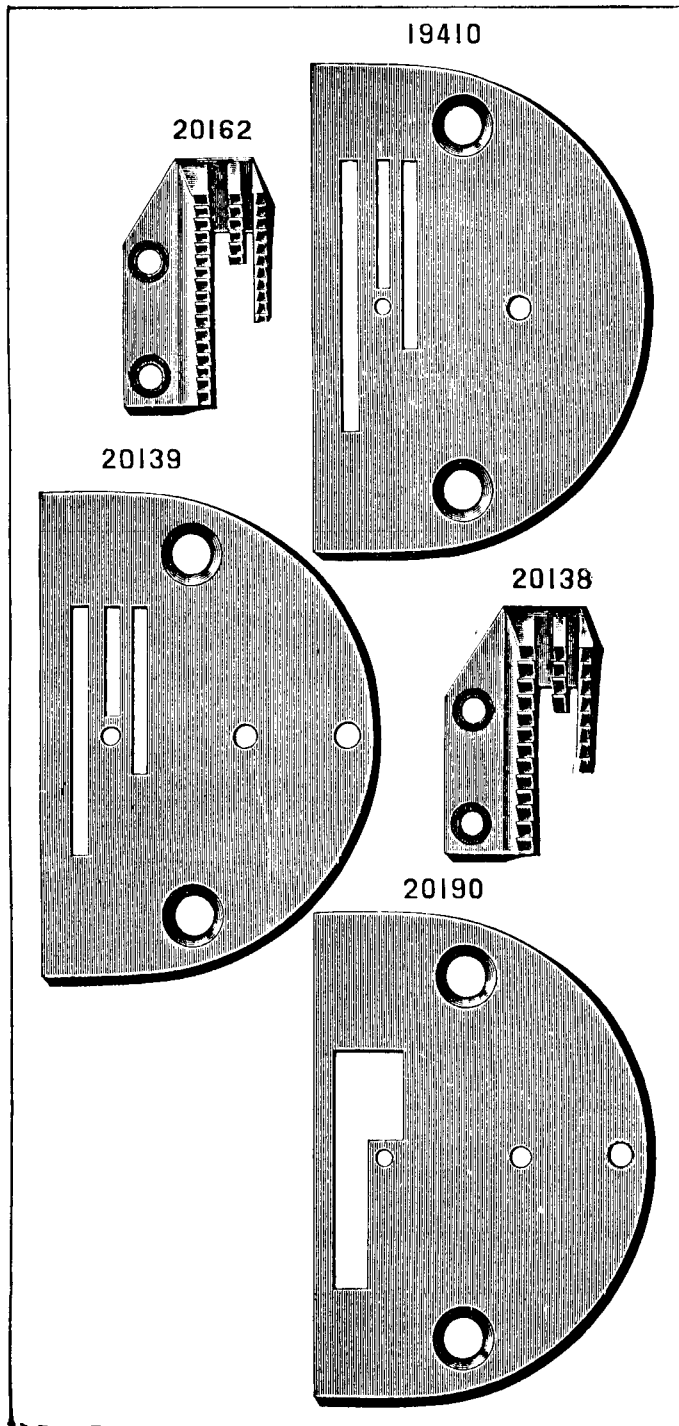


PLATE 2833—ONE-HALF SIZE

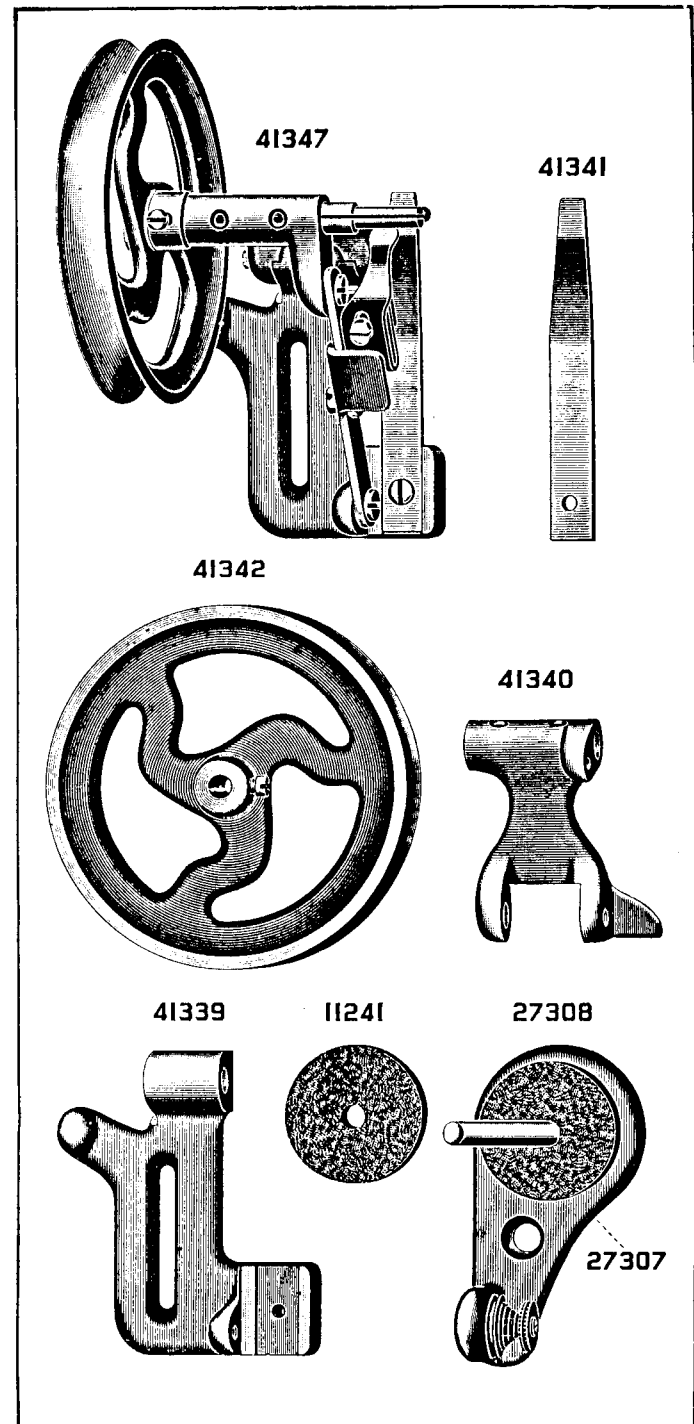


PLATE 2834—FULL SIZE

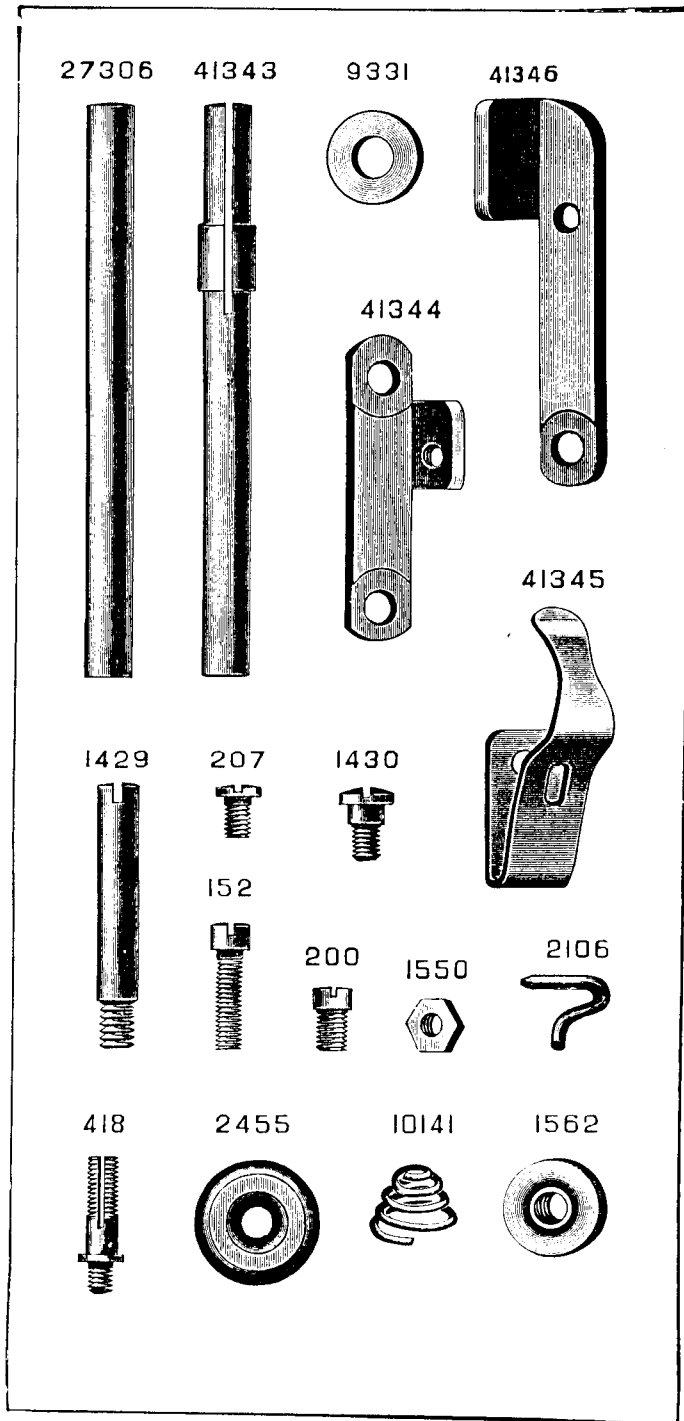


PLATE 5235—ONE-FOURTH SIZE

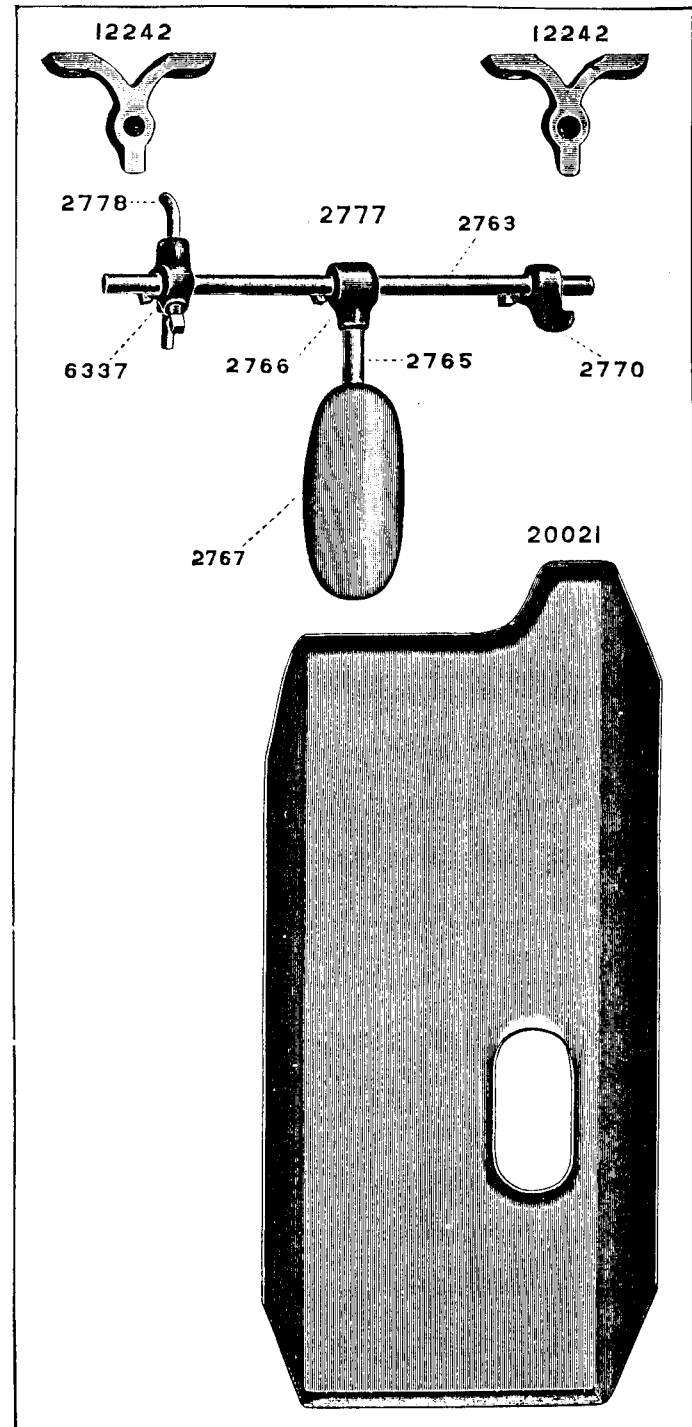


PLATE 5805—FULL SIZE

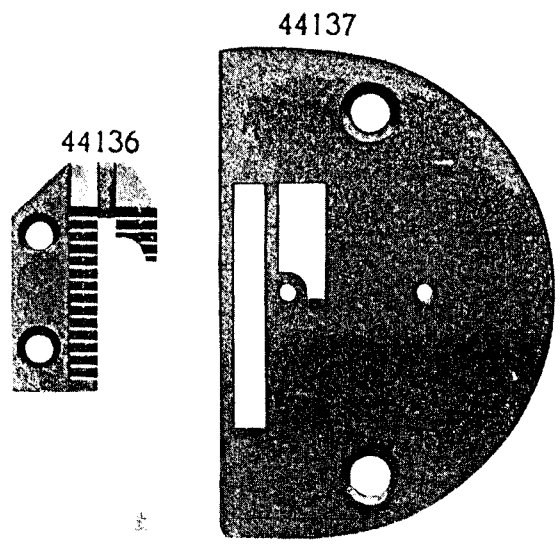


PLATE 5864—FULL SIZE

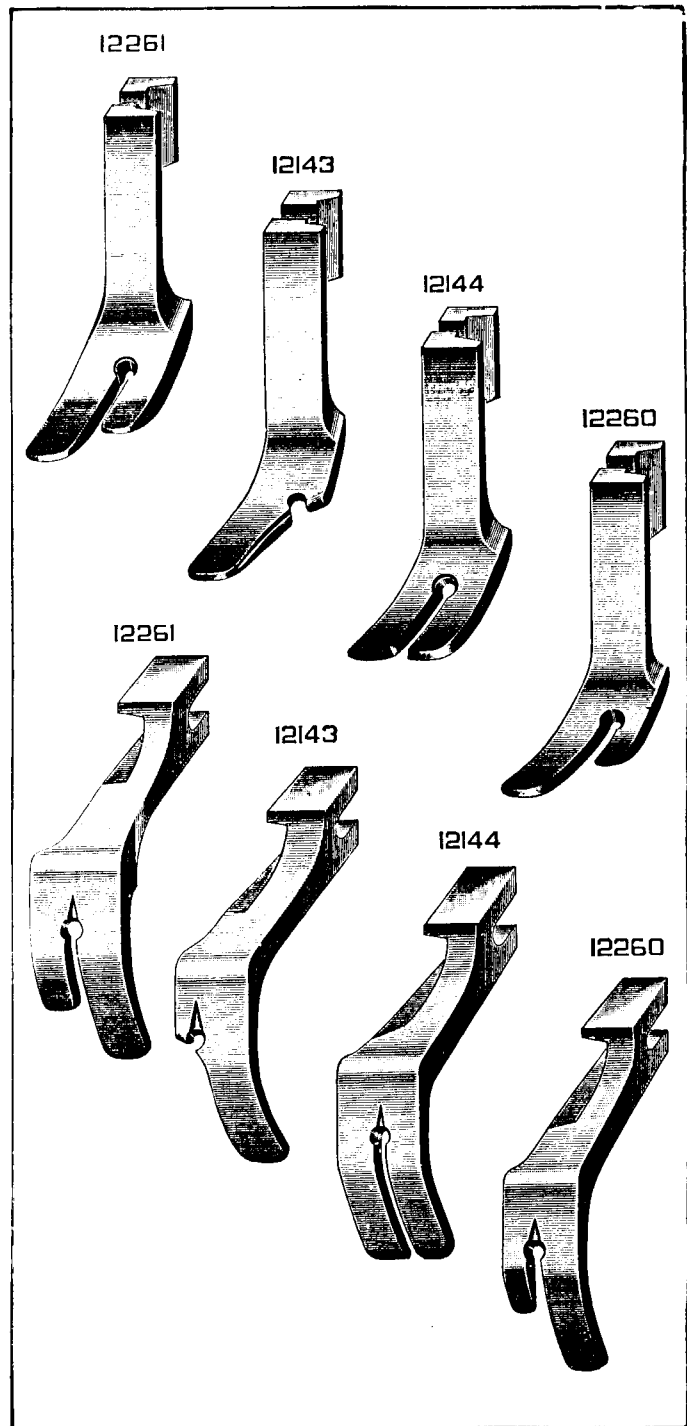
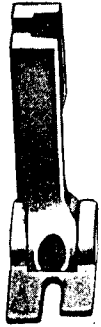


PLATE 5867—FULL SIZE

24983

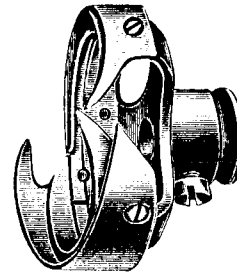


24983

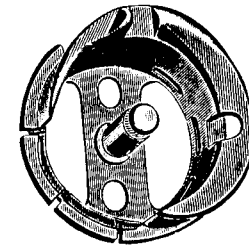


PLATE 5869—FULL SIZE

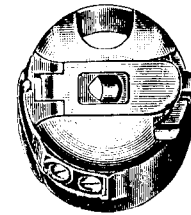
52076



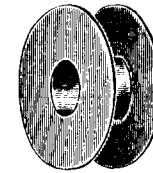
40396



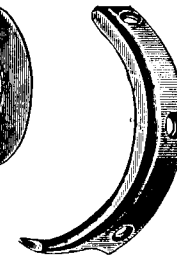
40395



40264



40274



40392



40409



2974



2975



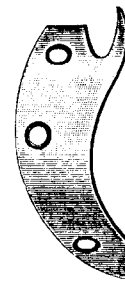
592



1367



40398



1053



40394



591



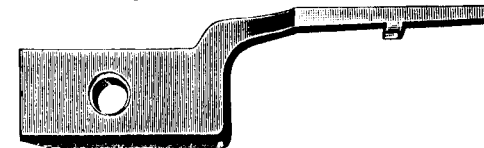
1380



1253



52018



704



PLATE 5875—FULL SIZE

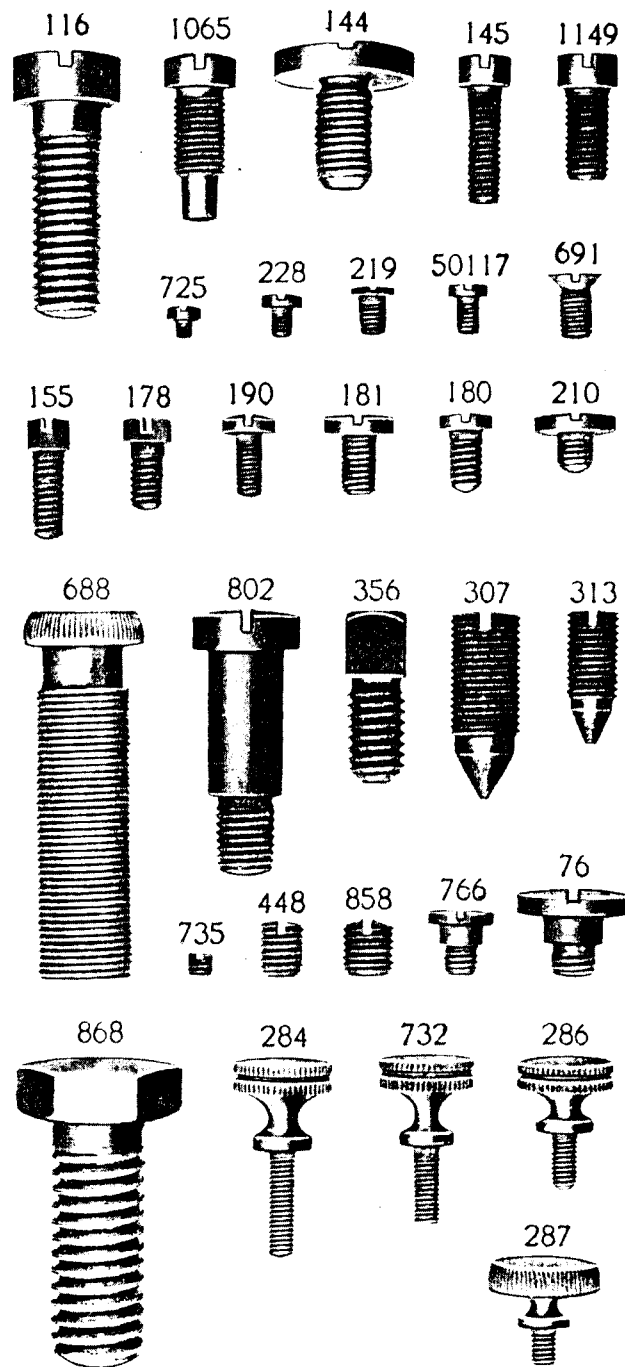


PLATE 5881—FULL SIZE

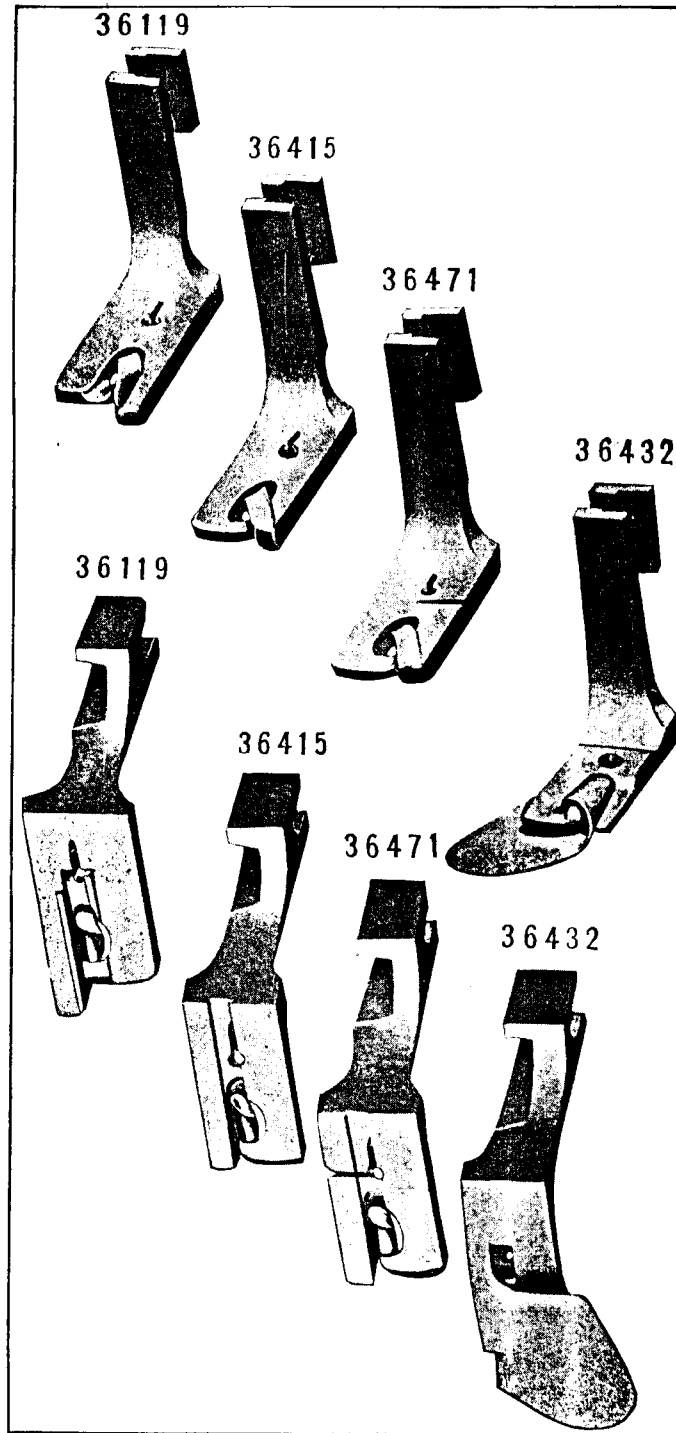
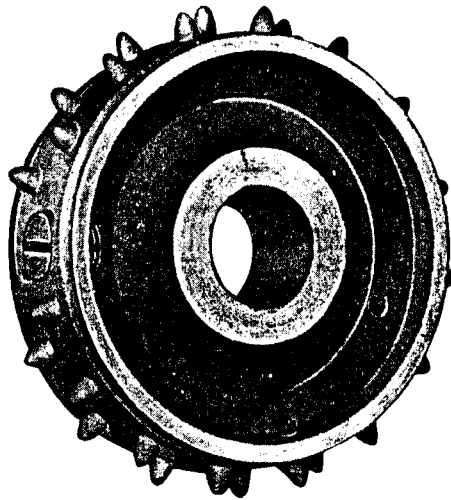
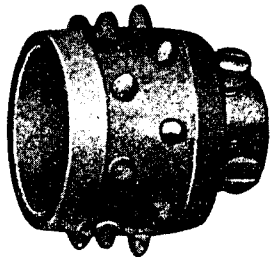


PLATE 5888—FULL SIZE

52050



52048



52049



PLATE 5892—FULL SIZE

36465



36464



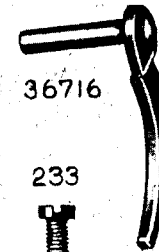
665



36717



36715

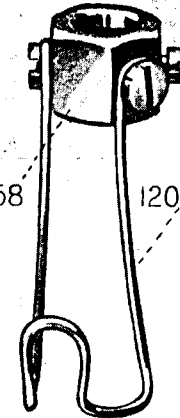


36716

233



120859



36773



25985



120858

120856

50302

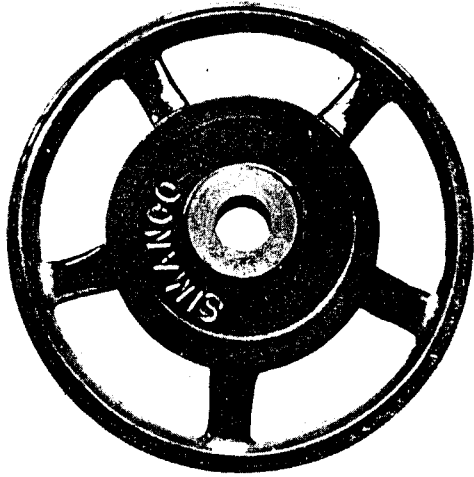


236



PLATE 5893—ONE-HALF SIZE

52005



52081

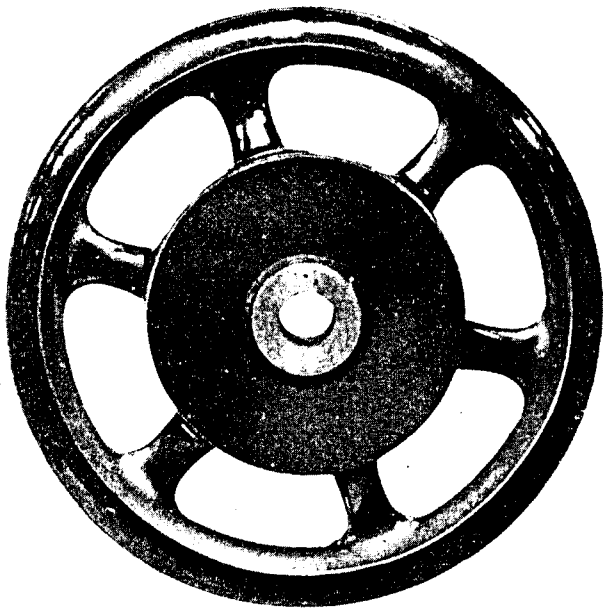
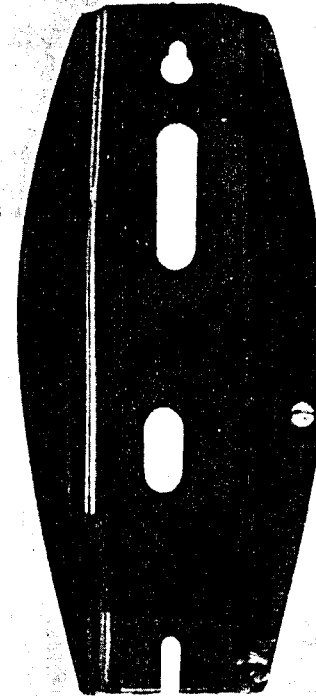
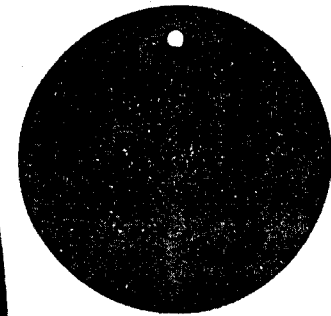


PLATE 5894—ONE-HALF SIZE

52052



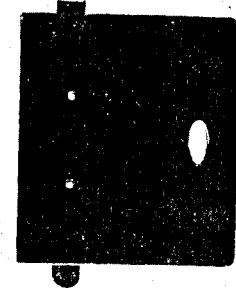
12193



4307



12432



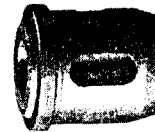
52059



52063



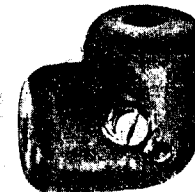
52078



12480



52072



52071

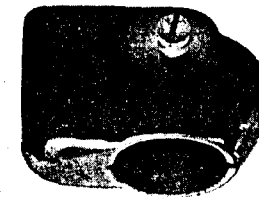


PLATE 5896—ONE-HALF SIZE

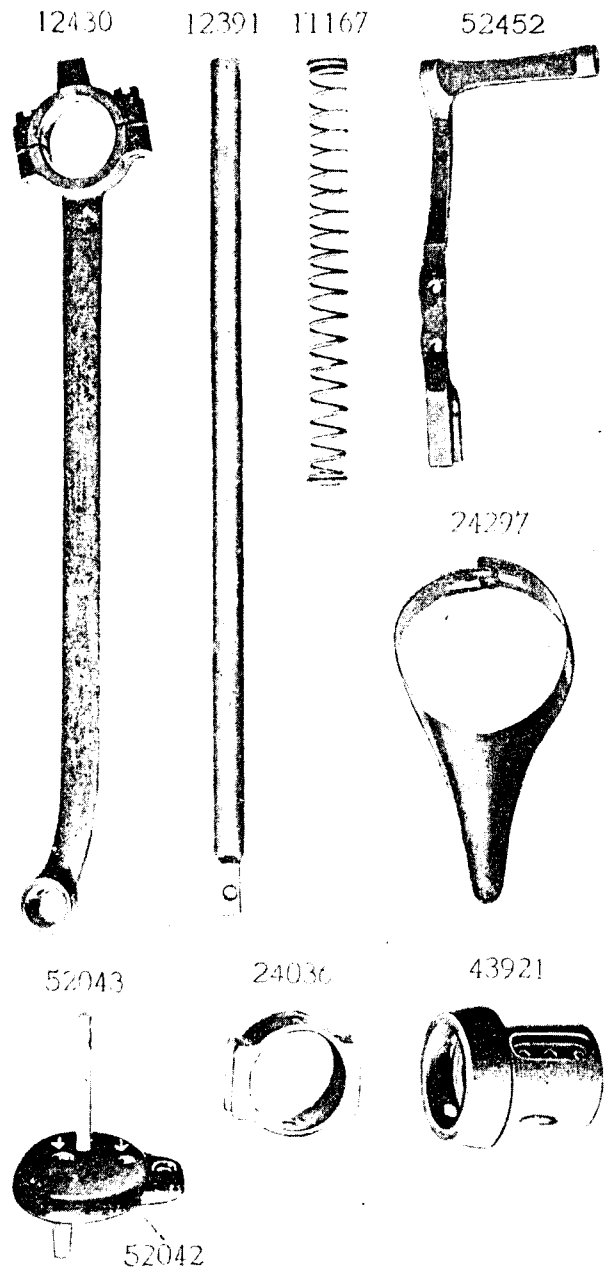


PLATE 5897—FULL SIZE

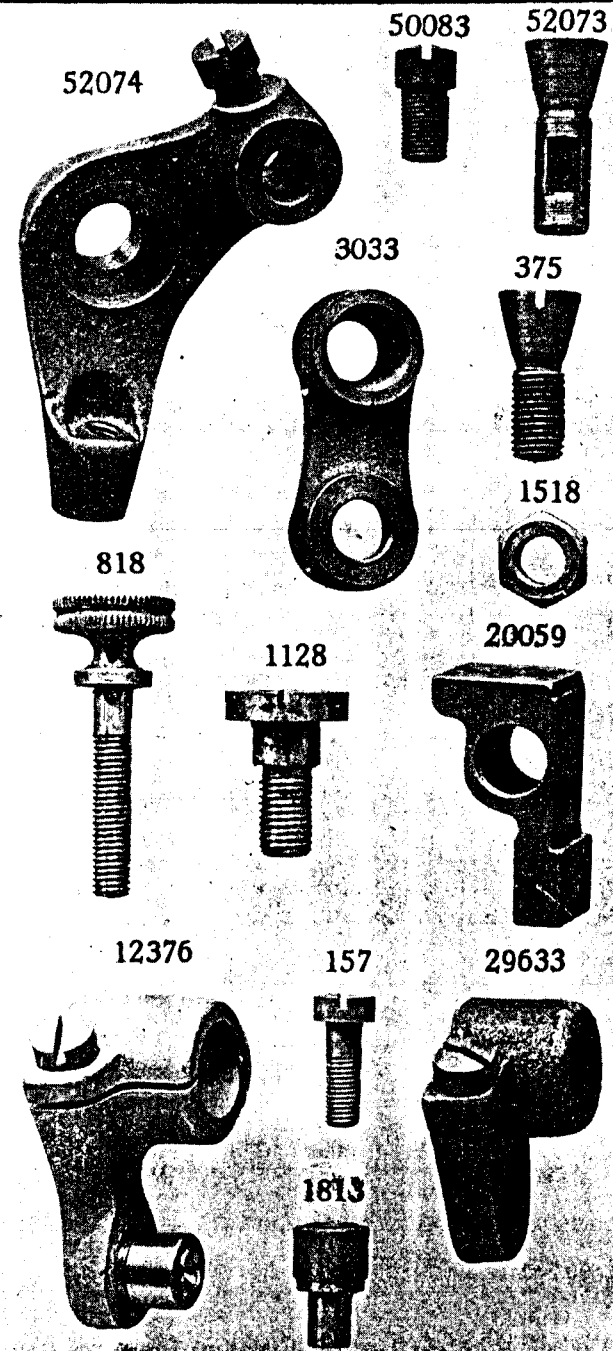
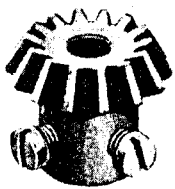


PLATE 5898—FULL SIZE

52062



56101



56100



447



56099



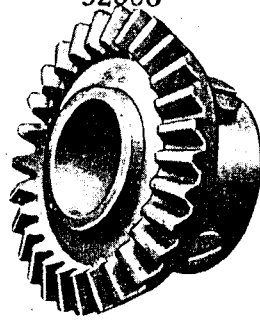
56013



1148



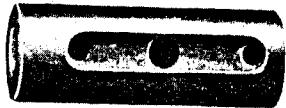
52060



56106



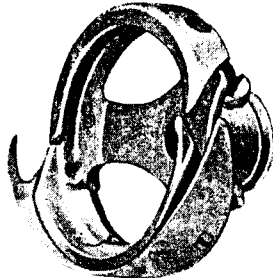
56107



52045



52089



52090

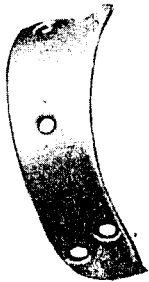


PLATE 5900—FULL SIZE

52084



12403



56006



54897



56015



2532



52378



29599



26231



12454



7298



52398



25446



18130



16532



210993



24131



52053



11119



41515



210958



56086



6267

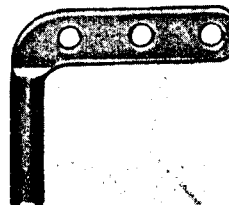


25888

25446



52454



36807



PLATE 5901—ONE-HALF SIZE

26026



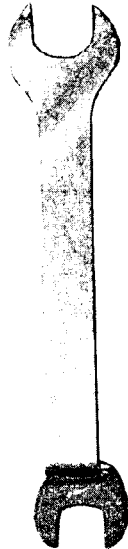
4822



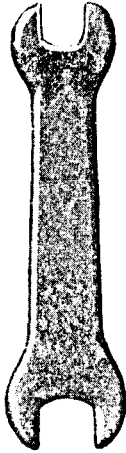
26485



4347

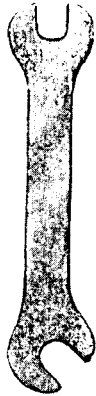


8909



120342

8908



120343

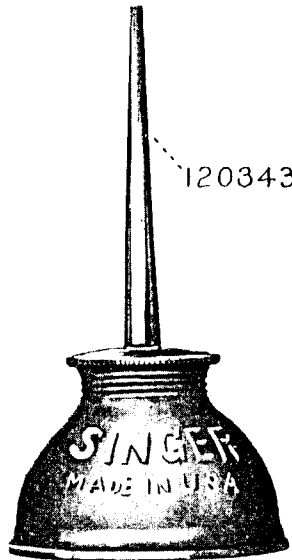
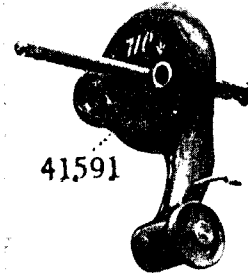


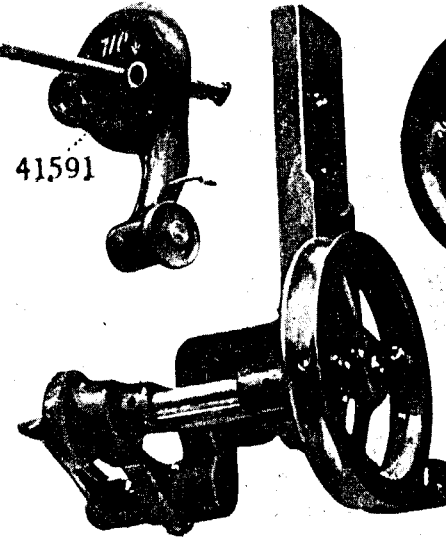
PLATE 5902—ONE-HALF SIZE

41592



41591

41915



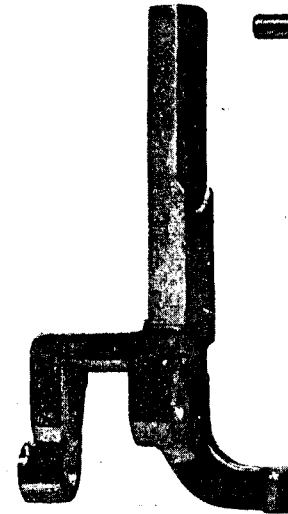
41585



41587



41913



41586



41583



41588



42614



41914



34105



PLATE 5932—FULL SIZE

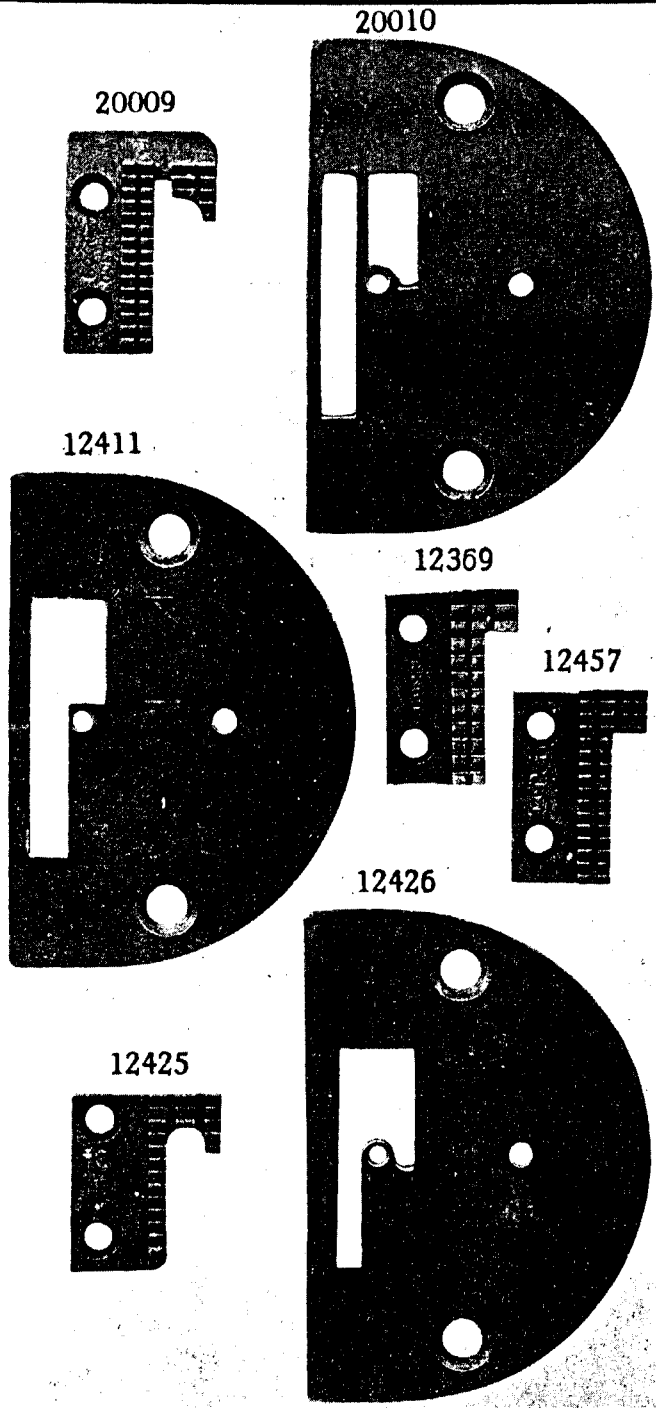


PLATE 5933—FULL SIZE

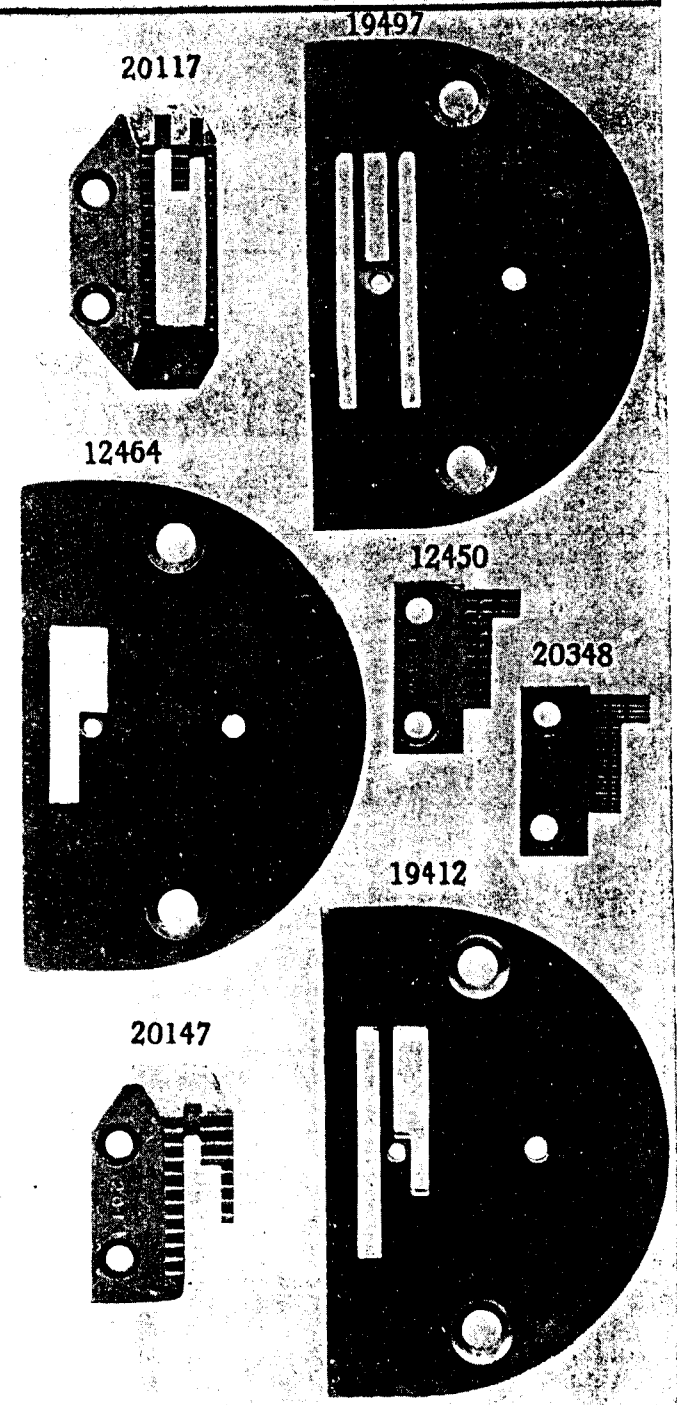


PLATE 5935—ONE-HALF SIZE

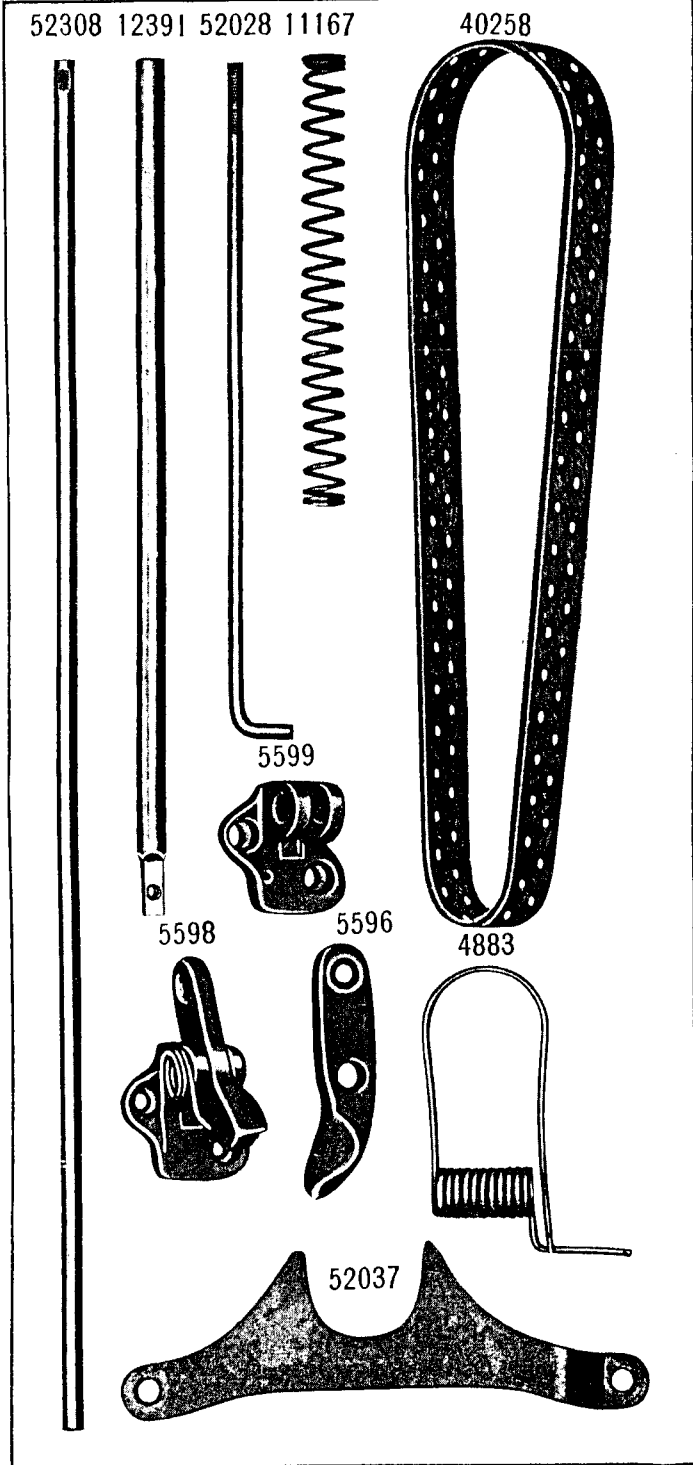


PLATE 5936—FULL SIZE

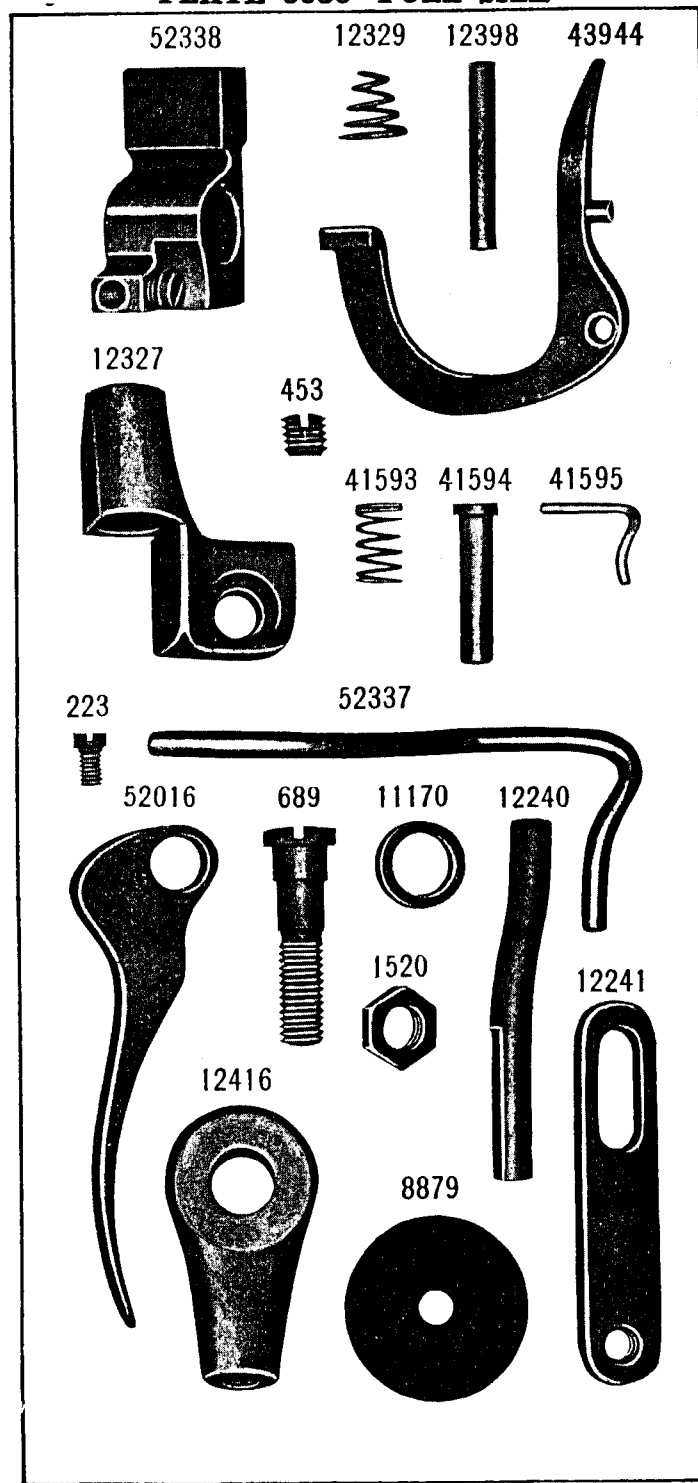


PLATE 5938—FULL SIZE

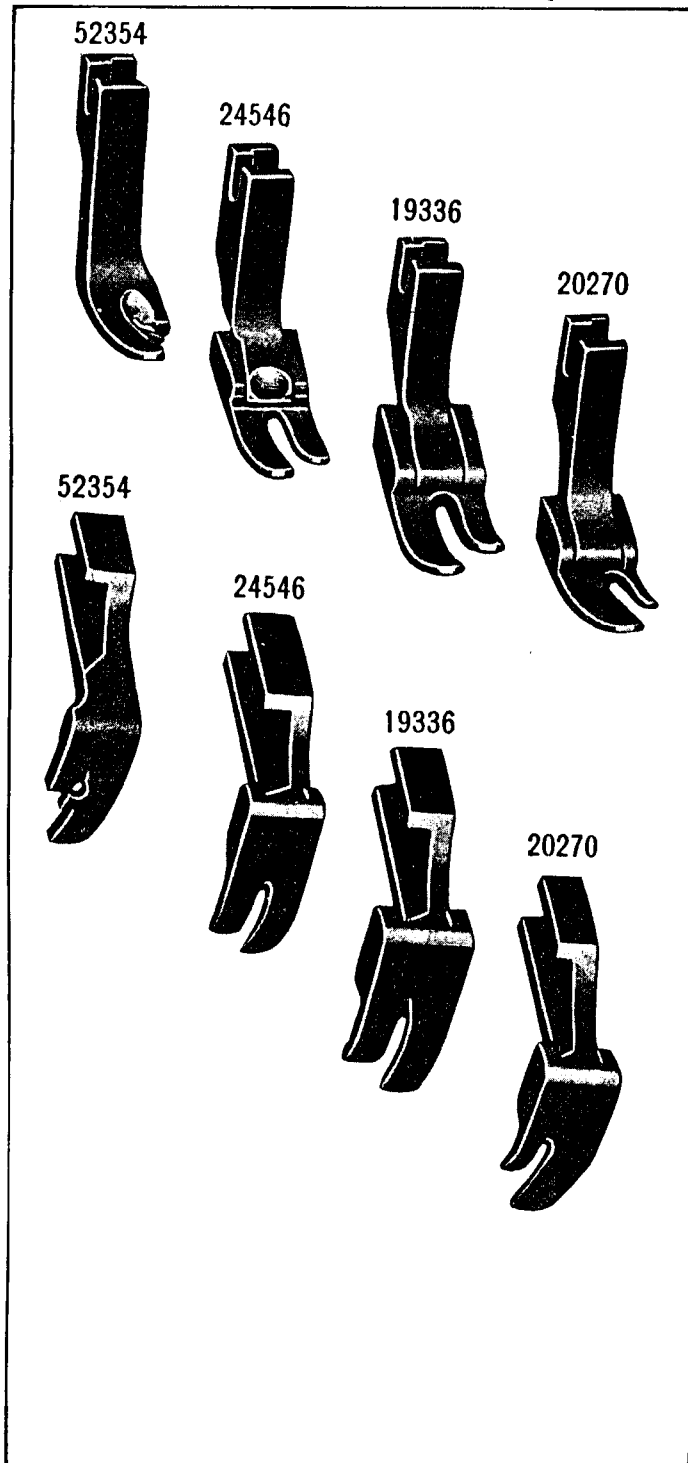


PLATE 5942—FULL SIZE

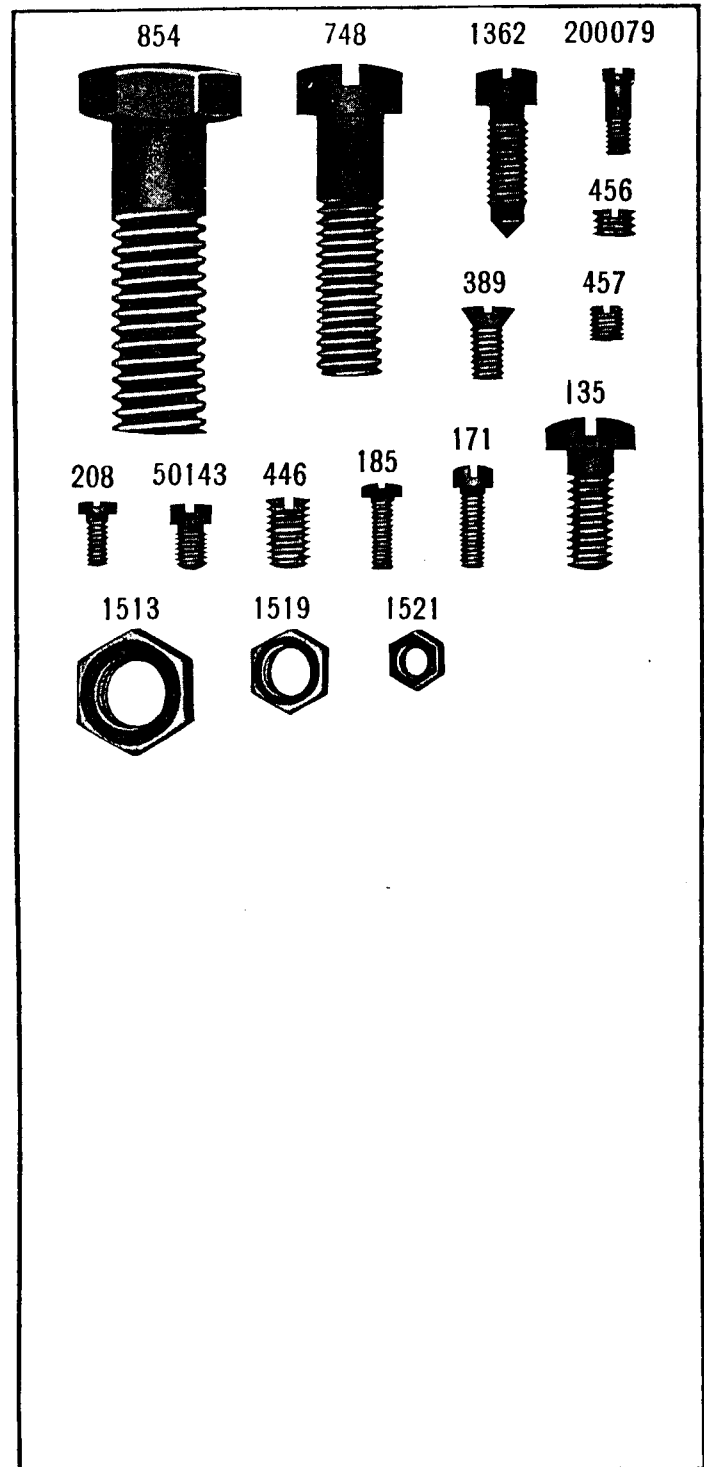


PLATE 5943—FULL SIZE

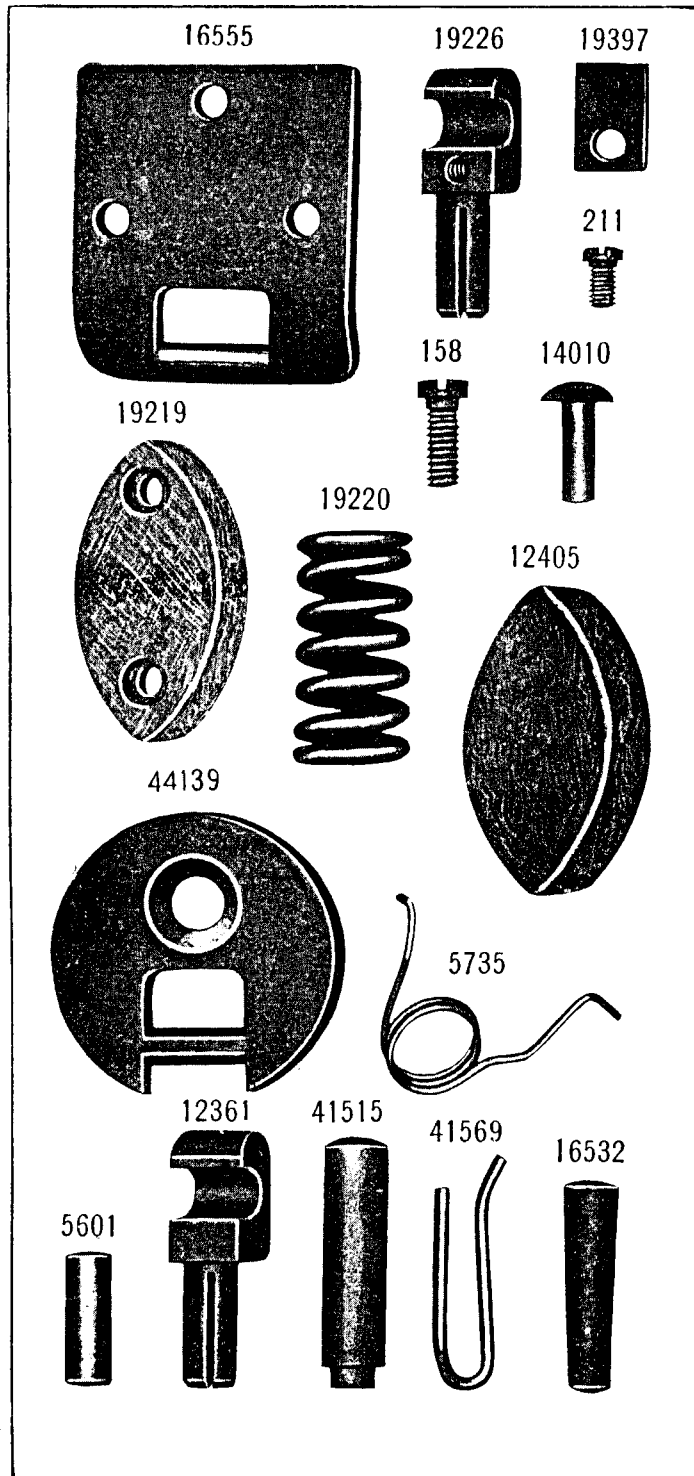


PLATE 5945—FULL SIZE

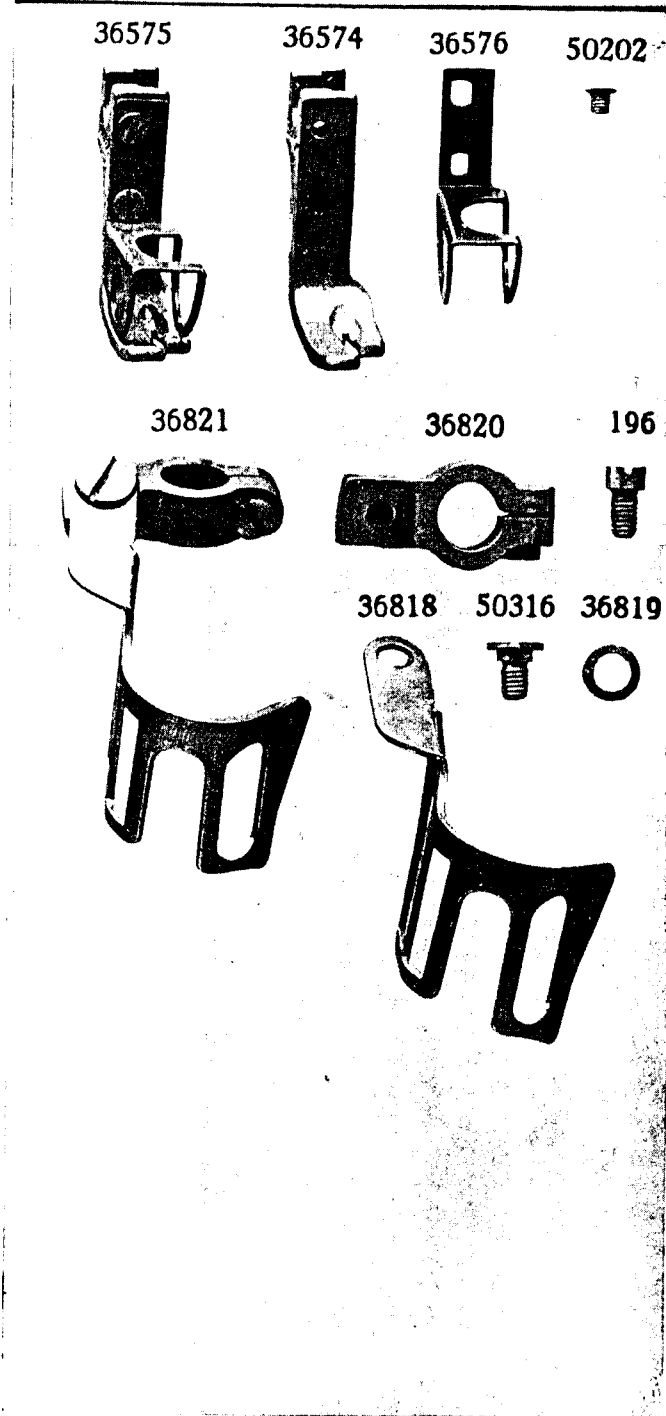


PLATE 5946 ONE-FOURTH SIZE

52382 52386 52384 52388 12237

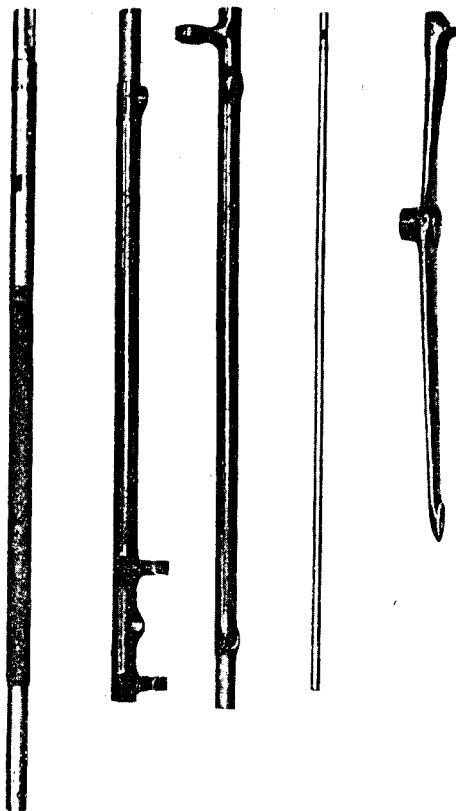


PLATE 5947—ONE-HALF SIZE

20284 24052 20283

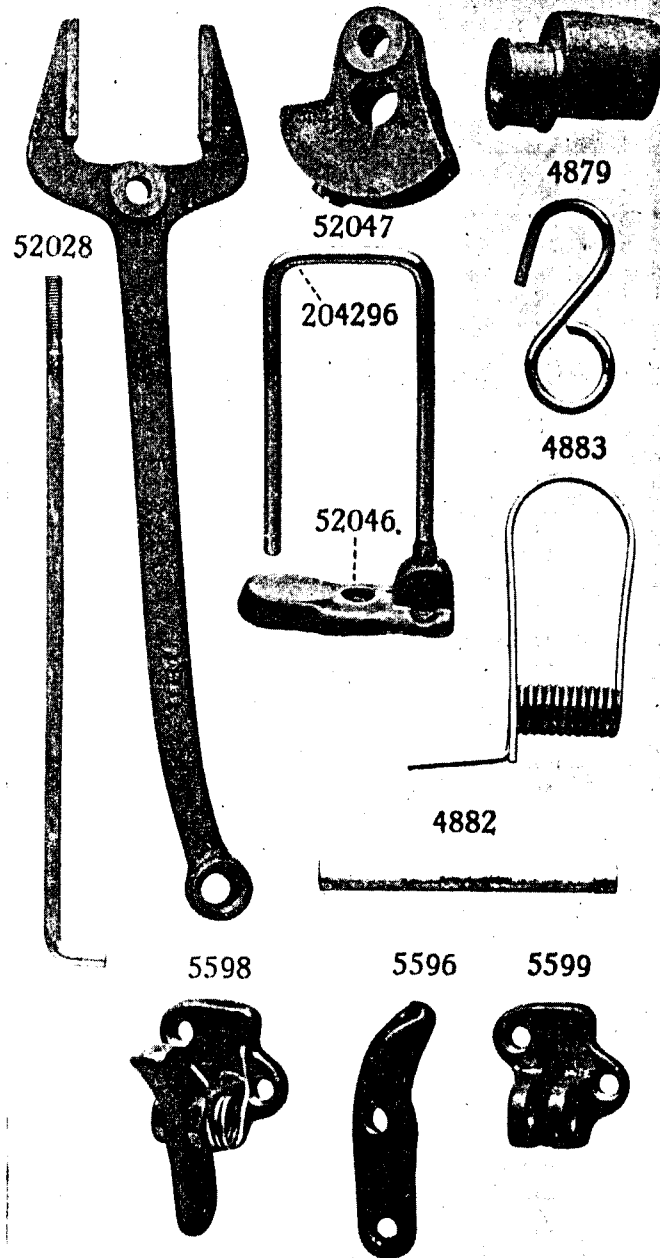


PLATE 5948—FULL SIZE

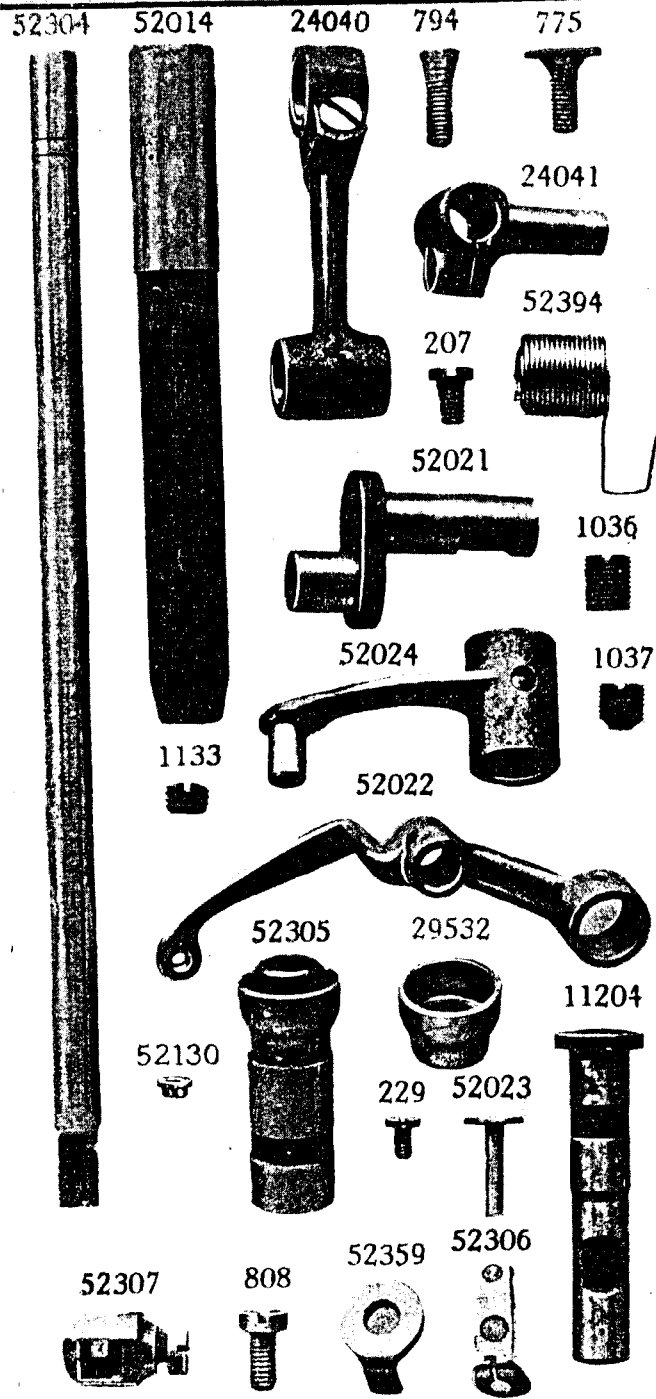


PLATE 5949—FULL SIZE

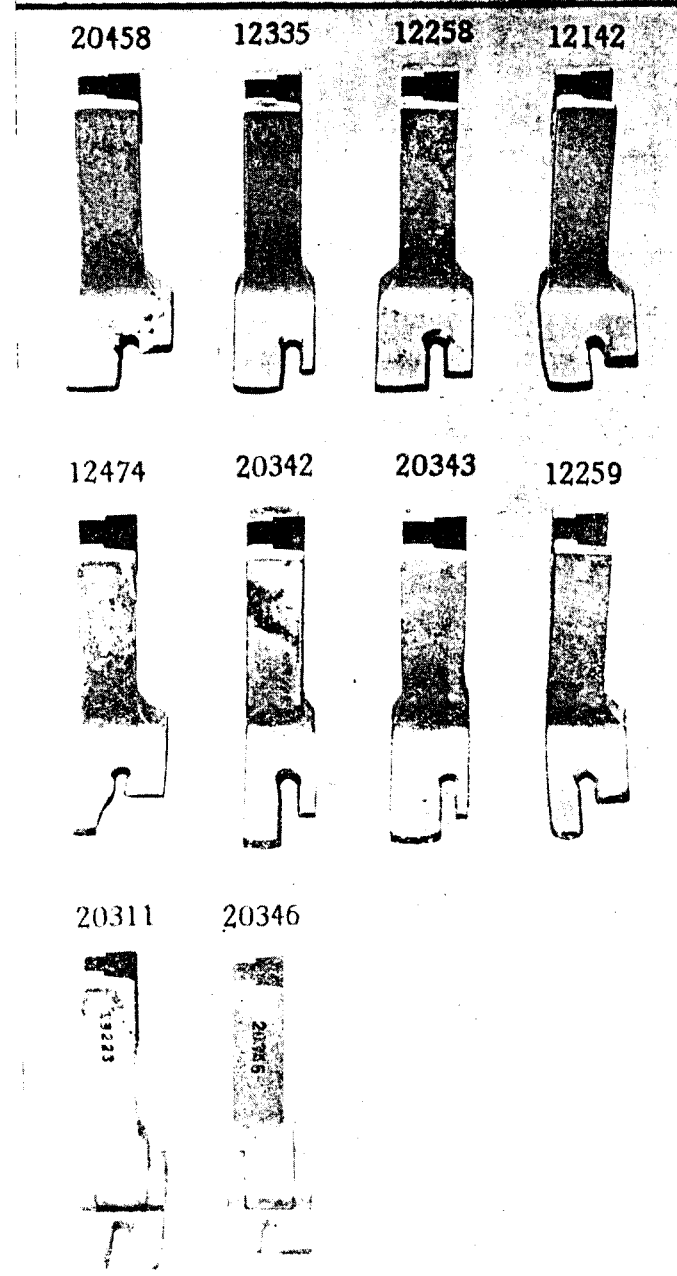
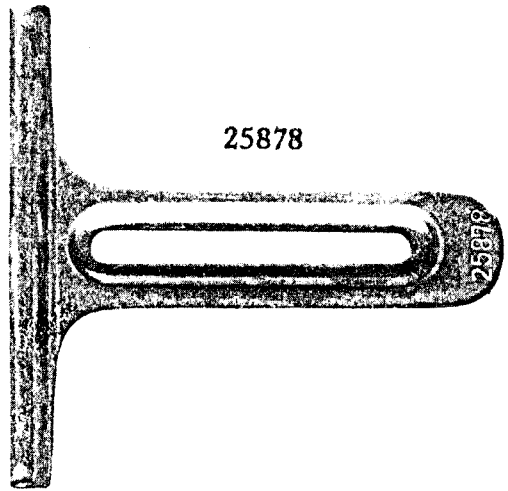
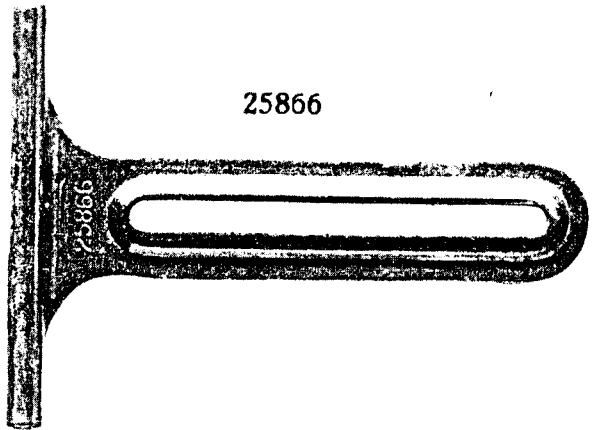


PLATE 6449—FULL SIZE



25878



25866

PLATE 7690—ONE-FOURTH SIZE

52302 52400 44125 12379



PLATE 7691—FULL SIZE

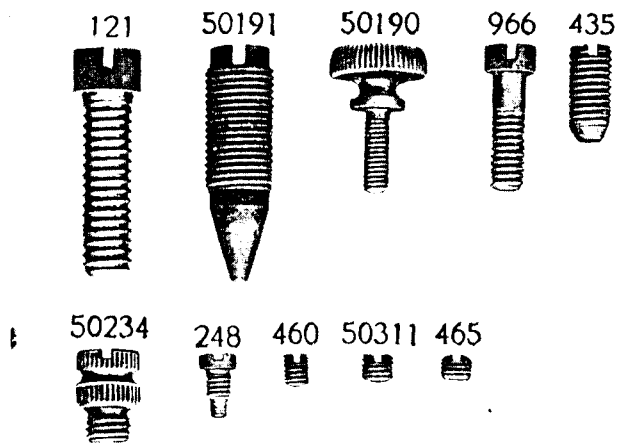


PLATE 7692—FULL SIZE

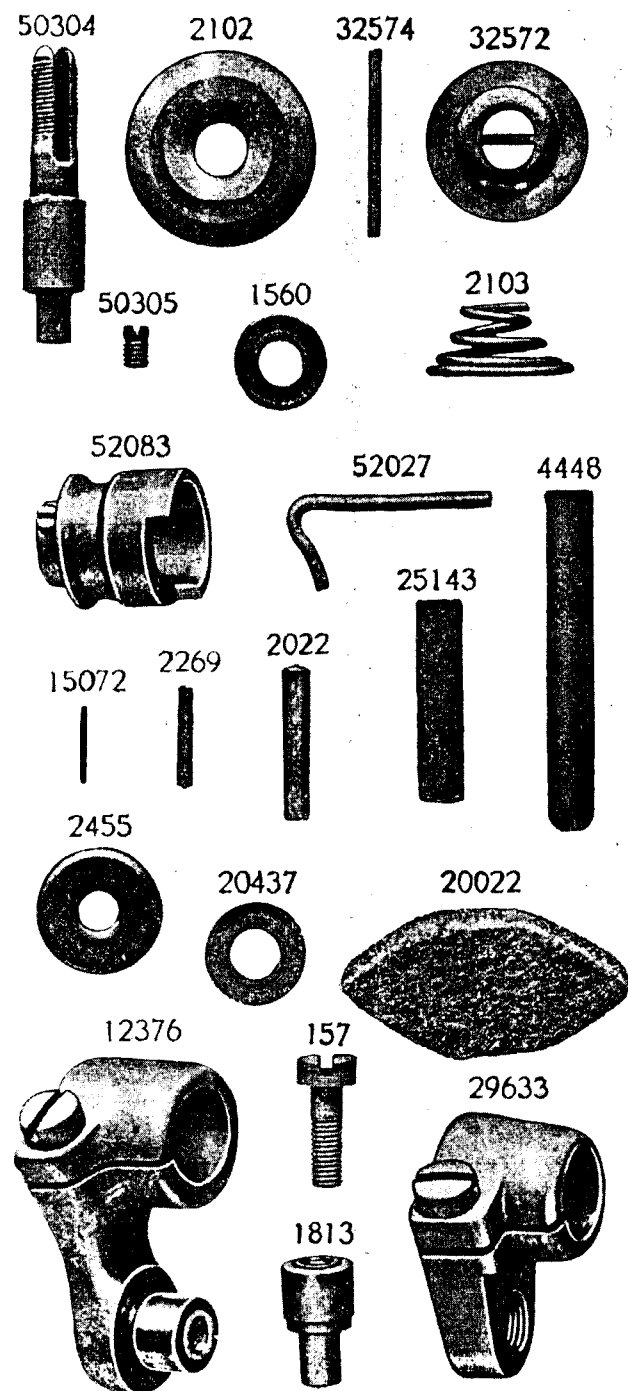


PLATE 7693—ONE-HALF SIZE

56017

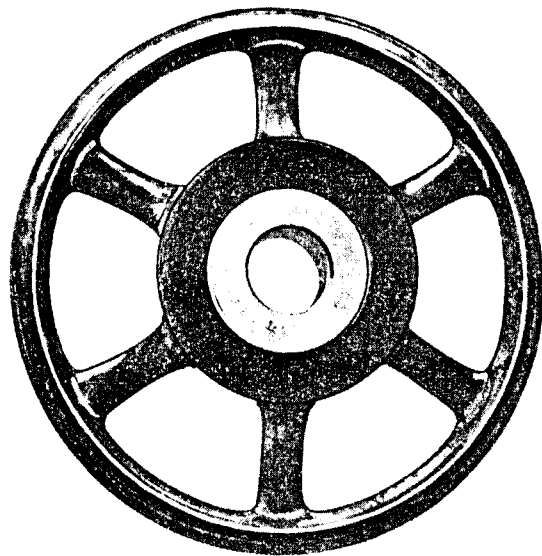


PLATE 7694—ONE-HALF SIZE

52028

52407

52406

24052

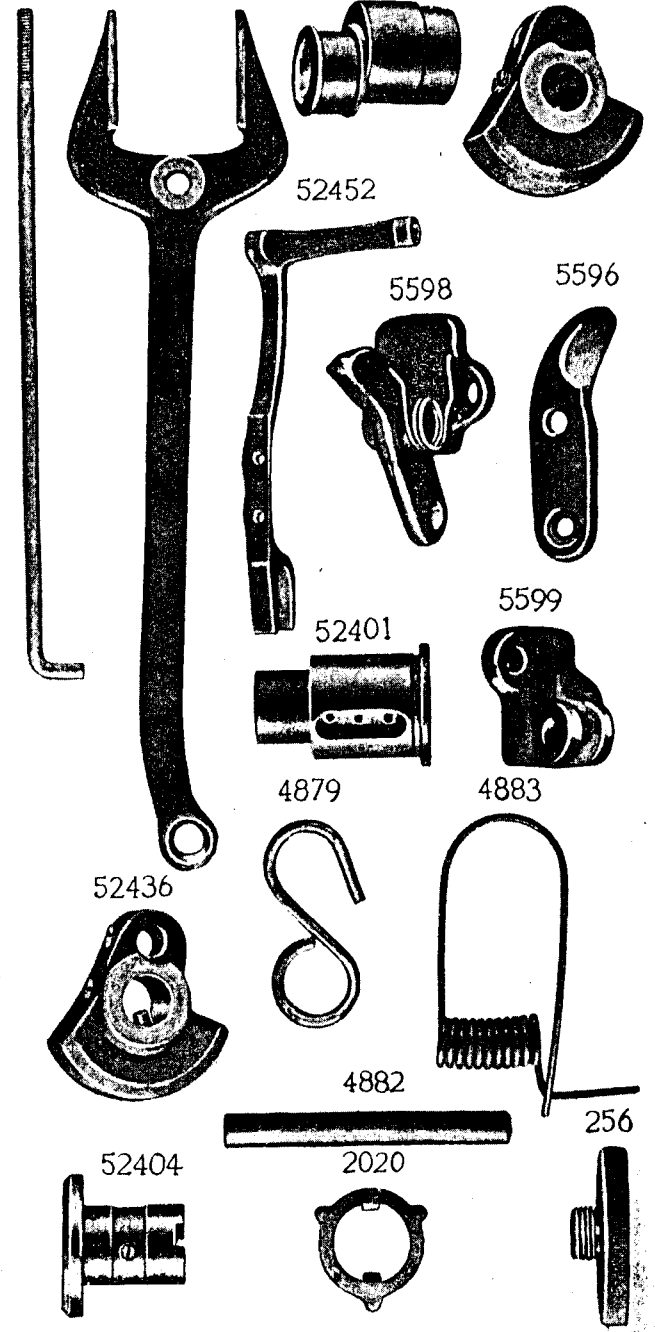


PLATE 7695—FULL SIZE

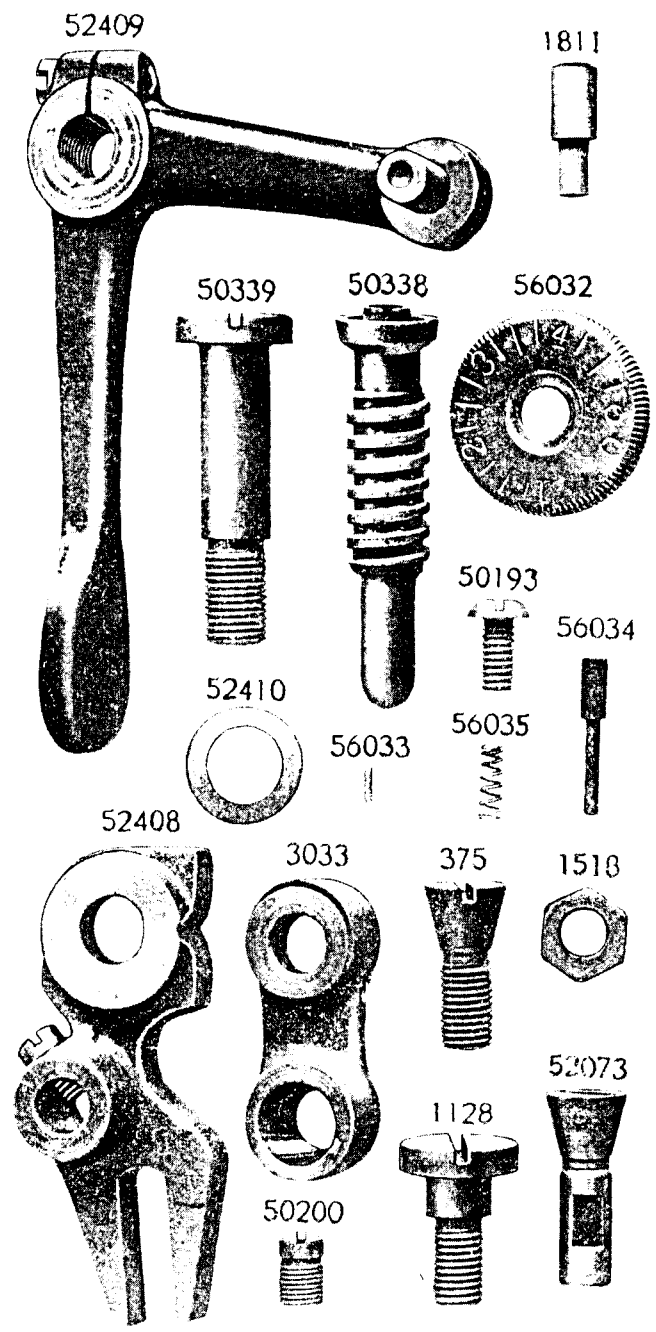


PLATE 7696—FULL SIZE

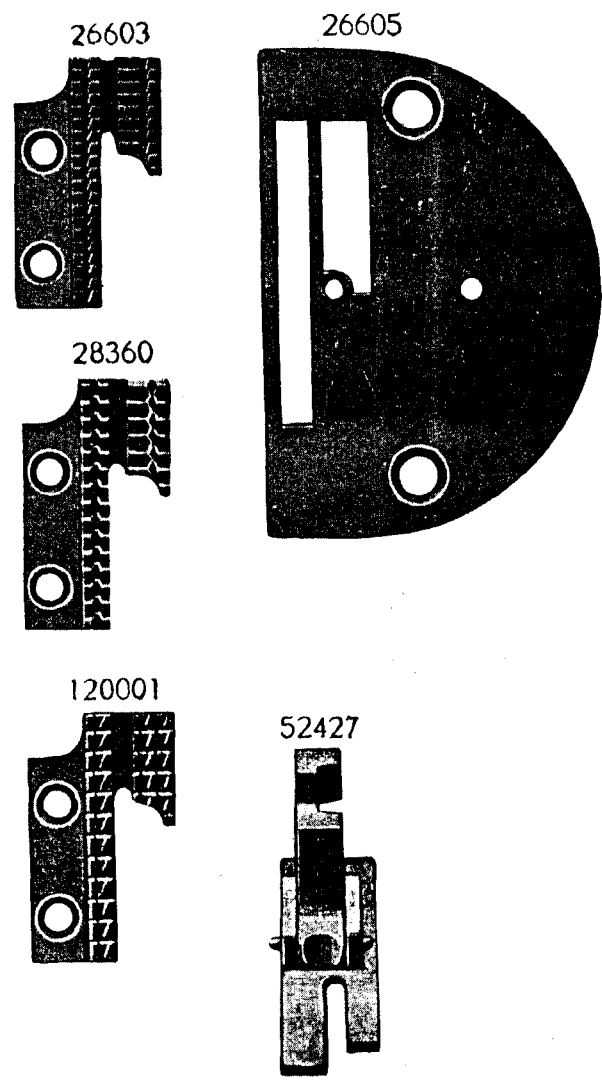
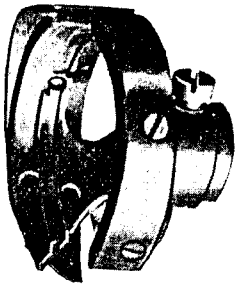


PLATE 7697—FULL SIZE

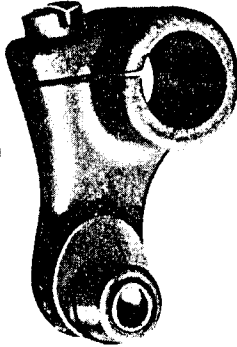
52448



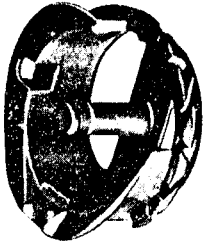
52440



52434



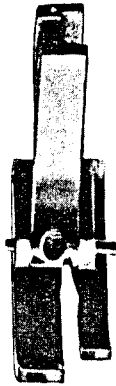
52443



7958



52439



52435



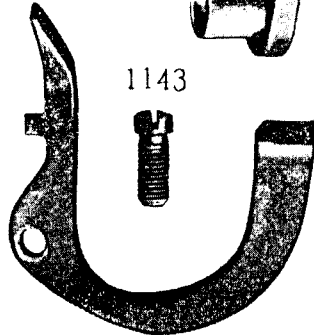
5990



52444



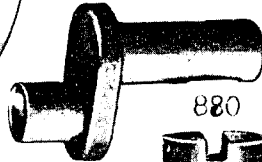
52445



1143



52446



880

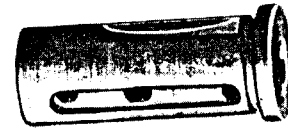


PLATE 7698—FULL SIZE

52455



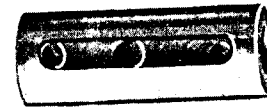
52039



50145



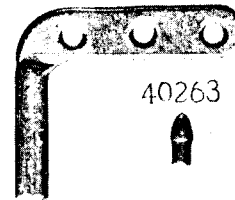
52044



1147



52454



50053



40263



3039

29534



62527

