

Singer 96-40

Singer 96-46

Form 18913, Revised  
(139)  
Printed in U. S. A.

# LIST OF PARTS



MACHINES  
Nos. 96-40 and 96-46

---

\*\* A TRADE MARK OF  
THE SINGER MANUFACTURING COMPANY

## INSTRUCTIONS FOR OILING

---

To ensure easy running and prevent unnecessary wear of the parts which are in movable contact, the machine requires oiling and when in continuous use, "TYPE B" or "TYPE D" OIL, sold only by Singer Sewing Machine Company, should be applied at least twice each day to all oil holes marked "OIL", as instructed in Form 7930.

"TYPE D" OIL is stainless.

**CAUTION:** Never oil the sewing hook race through the needle hole in the throat plate. Never flood the hook with oil.

Copyright, U. S. A., 1933 and 1939  
by The Singer Manufacturing Co.  
All Rights Reserved for all Countries

## INDEX

---

	Page
Accessories.....	14
Bobbin Winders.....	14
Foot Lifter Parts.....	17
Knee Lifter Parts.....	18
Machine Base.....	19
Machine No. 96-40.....	5
Machine No. 96-46.....	13
Numerical List of Parts.....	21
Thread Unwinder.....	19

## INSTRUCTIONS FOR ORDERING

In ordering from this list, use ONLY the part NUMBER in the FIRST column.

The number stamped on a Sewing Machine Part is in every case the number of the single part only.

Every combination of parts sent out as such has its specific number, which, although not stamped on the parts, must be used when ordering the combination.

Each number always indicates the SAME PART in whatever list it appears, or for whatever machine.

The letters after some of the numbers indicate the style of finish only, as follows:

- A-Hardened, Polished, Nickel Plated and Buffed
- A.A-Buffed and Chromium Plated
- A.B-Hardened, Polished, Buffed and Chromium Plated
- B-Polished, Nickel Plated and Buffed
- C-Hardened Only
- C.R-Hardened and Merlized
- D-Polished Only
- E-Soft, Not Polished
- F-Hardened and Polished
- F.J-Hardened, Polished and Nickel Plated
- G-Bright Rumbled and Nickel Plated
- H-Blued
- J-Nickel Plated Only
- K-Hardened and Nickel Plated
- L-Brass Plated
- M-Oxidized
- N-Japaned, Dull
- P-Japaned, Bright
- P.P-Wrinkle Finish
- R-Merlized
- S-Cadmium Plated
- T-Copper Plated
- T.A-Hardened, Polished, Copper and Nickel Plated and Buffed
- T.B-Copper and Nickel Plated and Polished
- T.J-Copper and Nickel Plated Only
- T.K-Hardened, Copper and Nickel Plated
- T.L-Copper and Brass Plated
- T.M-Copper Plated and Oxidized
- U-Zinc Plated
- V-Silver Plated
- W-Polished and Nickel Plated
- X-Black Oxide, for Iron and Steel
- X.C-Hardened and Black Oxide, for Iron or Steel
- Y-Black Nickel Plated Only
- Z-Chromium Plated
- Z.A-Hardened, Polished, Nickel Plated, Buffed and Chromium Plated
- Z.B-Polished, Nickel Plated, Buffed and Chromium Plated
- Z.C-Hardened and Chromium Plated
- Z.D-Polished and Chromium Plated
- Z.G-Bright Rumbled, Nickel Plated, Bright Rumbled and Chromium Plated
- Z.J-Nickel and Chromium Plated
- Z.T-Copper and Chromium Plated

These letters MUST BE USED when they appear in the list; and AFTER the number as in the list.

In this series:

- 1 to 1500, 50001 to 51500 and 140001 to 142000 are Screw Numbers
- 1501 to 1800 and 51501 to 51800 are Nut Numbers
- 1801 to 2000 and 51001 to 52000 are Roller Numbers
- 2001 to 50000 and 52001 to 140000 and 142001 to 190000 are Sewing Machine Parts, 190001 and upward are numbers of Electrical Parts.

The figures in the second column refer only to the plates, illustrating the parts, and are NOT TO BE USED in ordering.

Parts marked with an asterisk (\*) are furnished only when repairs are made at factory.

## LIST OF PARTS COMPLETE FOR

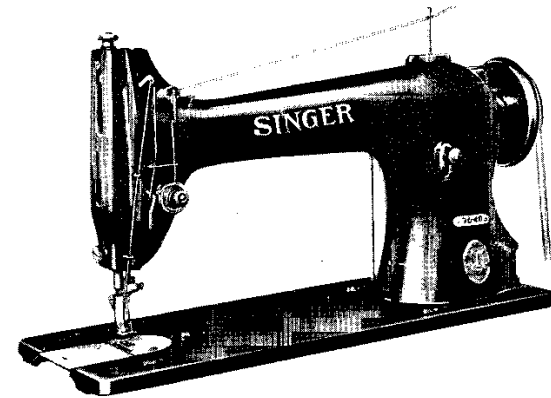

## MACHINE No. 96-40

For Cloaks, Clothing and Other Work in Cloth. Fitted with heavy gear shafts. The gears are lubricated with oil instead of grease. Speed up to 4000 R. P. M., according to the material being stitched.

No.	Plate	Name
*127213	-----	Arm with 15404 and two each 15405 and 56015.....
16532	22246	Arm Dowel Pin.....
52182	22246	" Oil Tube with 52184, for oiling 52205.....
52183	22246	Arm Oil Tube with 52184, for oiling 52024 and 127156, for 127193 and 150460.....
127187	22246	Arm Oil Tube (bent) with 42387, for oiling 127152, for 127193 and 150460.

Note: Due to the accuracy required for gear alignment, Arm cannot be supplied separately and can only be sent out as a unit, Arm and Bed assembled.

## PARTS FOR MACHINE No. 96-40

No.	Plate	Name
52180	22246	Arm Oil Tube (long) with 52184, for oiling 52022.....
52185	22246	Arm Oil Tube (short) with 42367, for oiling 52022.....
52148	22246	Arm Oil Tube for 52149.....
52149	22246	" " " 52148 with 52150, for oiling 127073 and 127074.....
56015	22246	Arm Oil Tube for oiling 127058.....
52150	22246	" " " Packing (braided cotton) for 52149.....
42367	22246	Arm Oil Tube Packing (braided cotton) for 52185 and 127187.....
52184	22246	Arm Oil Tube Packing (wick) for 52180, 52182 and 52183.....
116E	22246	Arm Screw (back).....
854E	22246	" " (front).....
127047	22242	" Shaft (horizontal).....
127197	-----	" " " 127047 with 52196 and 127253.....
127072	22242	Arm Shaft (horizontal) Bevel Gear with two 1036C.....
127070	22242	Arm Shaft (horizontal) Bevel Gear Case (two pieces) with 121E.....
121E	22242	Arm Shaft (horizontal) Bevel Gear Case Screw.....
1036C	22242	Arm Shaft (horizontal) Bevel Gear Set Screw.....
52191	22242	Arm Shaft (horizontal) Flanged Bushing (back).....
52192	-----	Arm Shaft (horizontal) Flanged Bushing (back) 52191 with 52193 and 52194..
52193	22242	Arm Shaft (horizontal) Flanged Bushing (back) Oil Pad (inside) braided cotton.....
52194	22242	Arm Shaft (horizontal) Flanged Bushing (back) Oil Pad (outside) felt.....
448C	22242	Arm Shaft (horizontal) Flanged Bushing (back) Set Screw.....
52195	22242	Arm Shaft (horizontal) Flanged Bushing (front).....
52196	-----	Arm Shaft (horizontal) Flanged Bushing (front) 52195 with 52193 and 52198.
52193	22242	Arm Shaft (horizontal) Flanged Bushing (front) Oil Pad (inside) braided cotton.....
52198	22242	Arm Shaft (horizontal) Flanged Bushing (front) Oil Pad (outside) felt.....
435C	22242	Arm Shaft (horizontal) Flanged Bushing (front) Set Screw.....

## PARTS FOR MACHINE No. 96-40

No.	Plate	Name
68350	22246	Arm Shaft (horizontal) Front Bearing Oil Cup.....
144D	22242	Arm Shaft (horizontal) Screw.....
127058	22242	" " (upright).....
127073	22242	" " " Bevel Gear (lower) with two 1259C.....
1259C	22242	Arm Shaft (upright) Bevel Gear (lower) Set Screw.....
127074	22242	Arm Shaft (upright) Bevel Gear (upper) with two 1259C.....
1259C	22242	Arm Shaft (upright) Bevel Gear (upper) Set Screw.....
52492	22242	Arm Shaft (upright) Bushing (lower)....
432C	22242	" " " " " Set Screw.....
52493	22242	Arm Shaft (upright) Bushing (upper)....
435C	22242	" " " " " Set Screw.....
127146	22244	Arm Side Cap.....
219J	22244	" " " Screw.....
127079	22246	" " Cover.....
50053J	22246	" " " Thumb Screw.....
52239	22246	" Spool Pin and Thread Eyelet.....
8879	22246	" " " Washer (cloth).....
127192	22246	" Top Cover.....
127193	-----	" " " 127192 with 52183, 52239, 127187 and 127255.....
127255	22246	Arm Top Cover Positioning Disc.....
158J	22246	" " " Screw.....
52187	22242	Balance Wheel (power, disc) 2 3/16 in. pulley with two 448C.....
52063	22242	Balance Wheel Oil Cover.....
210J	22242	" " " " " Screw.....
448C	22242	" " " " " Set Screw.....
*52383	-----	Bed.....
Note: Due to the accuracy required for gear alignment, Bed cannot be supplied separately and can only be sent out as a unit, Arm and Bed assembled.		
12431	22243	Bed Slide.....
4307	22243	" " Spring.....
725J	22243	" " " Screw.....
12432	22243	Bed Slide complete, Nos. 4307, 12431 and two 725J.....
52051	22243	Face Plate.....
176J	22243	" " Screw.....
52053	22243	" " Thread Guard (lower).....
226J	22243	" " " " " " Screw..
52170	22243	" " " " " (upper).....

## PARTS FOR MACHINE No. 96-40

No.	Plate	Name
226J	22243	Face Plate Thread Guard (upper) Screw..
52052	-----	Face Plate complete, Nos. 52051, 52053, 52170 and two 226J.....
50190J	22243	Face Plate Thumb Screw.....
52452	22244	Feed Bar.....
313C	22244	" " Screw Center.....
56813	-----	" " " " 313C with 1519J..
1519J	22244	" " " " Nut.....
52165	22242	" Connecting Link.....
375C	22242	" " " " Hinge Screw.....
1518J	22242	" " " " " Nut....
52073	22242	" " " " Stud.....
50083C	22242	" " " " Set Screw
127087	22243	" Dog, for general work, 19 teeth (16 teeth to the inch) for 127106 and 127107.....
50117E	22243	Feed Dog Screw.....
127202	22242	" and Feed Lifting Eccentric with 448C, 1299C, 52210 and 52211.....
52210	-----	Feed and Feed Lifting Eccentric Lubri- cating Pad (long) wood.....
52211	-----	Feed and Feed Lifting Eccentric Lubri- cating Pad (short) wood.....
1299C	22242	Feed and Feed Lifting Eccentric Posi- tion Screw.....
448C	22242	Feed and Feed Lifting Eccentric Set Screw.....
127152	22242	Feed and Feed Lifting Eccentric Sleeve.
20284	22242	" Forked Connection.....
52393	-----	" " " 20284 with 375C, 1518J and 52165.....
375C	22242	Feed Forked Connection Hinge Screw....
1518J	22242	" " " " Nut.
52384	22244	" Lifting Rock Shaft.....
127269	-----	Feed Lifting Rock Shaft complete, Nos. 52265 and 52384.....
127156	22242	Feed Lifting Rock Shaft Connecting Rod with two 966E.....
966E	22242	Feed Lifting Rock Shaft Connecting Rod Cap Screw.....
375C	22242	Feed Lifting Rock Shaft Connecting Rod Hinge Screw.....
1518J	22242	Feed Lifting Rock Shaft Connecting Rod Hinge Screw Nut.....
*52271	-----	Feed Lifting Rock Shaft Crank.....
52265	22244	" " " " 52271 with 157J and 52267.....
157J	22244	Feed Lifting Rock Shaft Crank Clamping Screw.....

## PARTS FOR MACHINE No. 96-40

No.	Plate	Name
52266	-----	Feed Lifting Rock Shaft Crank Slide Block.....
52267	22244	Feed Lifting Rock Shaft Crank Slide Block 52266 with 125060.....
*125060	-----	Feed Lifting Rock Shaft Crank Slide Block Stud.....
50191C	22244	Feed Lifting Rock Shaft Screw Center...
52097	-----	" " " " " " 50191C with 1513J.....
1513J	22244	Feed Lifting Rock Shaft Screw Center Nut.....
52074	22242	Feed Regulator with 50083C.....
52118	-----	" " 52074 with 52073.....
52093	-----	" " 52118 with 818D.....
1128E	22242	" " Hinge Screw.....
818D	22242	" " Thumb Screw.....
52386	22244	" Rock Shaft.....
29633	22244	" " " Crank with 157J.....
157J	22244	" " " Clamping Screw...
52387	-----	Feed Rock Shaft complete, Nos. 29633 and 52386.....
50191C	22244	Feed Rock Shaft Screw Center.....
52097	-----	" " " " 50191C with 1513J.....
1513J	22244	Feed Rock Shaft Screw Center Nut.....
25866	22246	Guide.....
50190J	22246	" Thumb Screw.....
127088	22245	Needle Bar (hollow).....
127116	-----	" " 127088 with 229J, 52306 and 52307.....
127230	22245	Needle Bar Bushing (lower).....
1133E	22245	" " " " Set Screw...
52014	22245	" " " (upper).....
1133E	22245	" " " Set Screw...
52205	22245	" " Connecting Link with 52207..
52206	-----	" " " " 52205 with 24041.....
775E	22245	Needle Bar Connecting Link Cap Screw...
52207	-----	" " " " Lubricating Pad (wood).....
24041	22245	Needle Bar Connecting Stud with 207E...
207E	22245	" " " Clamping Screw
127253	22242	" " Crank with 1036C, 1037C and 1065C.....
1065C	22242	Needle Bar Crank Position Screw.....
52306	22245	" " Thread Guard.....
229J	22245	" " " " Screw.....
52307	22245	" Clamp with 51460F.....
51460F	22245	" " Screw.....

No.	Plate	Name
52202	22246	Oil Absorbent Wick for lower cavity in head of arm.....
127191	22246	Oil Tube with 52184.....
127091	22246	" " Bracket.....
127092	22246	" " " 127091 with 127191, for oiling Feed Connecting Link.....
52184	22246	Oil Tube Packing (wick).....
12391	22245	Presser Bar (hollow).....
52338	22245	" " Guide Bracket with 223C and 453C.....
453C	22245	Presser Bar Guide Bracket Set Screw....
52016	22245	" " Lifter.....
689C	22245	" " " Hinge Screw.....
1520J	22245	" " " " Nut.....
12327	22245	" " Lifting and Releasing Lever Bracket.....
127108	22245	Presser Bar Spring.....
11170	22245	" " " Washer.....
7298	22245	" Foot Hinge Pin.....
19334	22245	" " Plate.....
19335	22245	" " Shank.....
19336	22245	Presser Foot (hinged) complete, Nos. 7298, 19334 and 19335.....
176J	22245	Presser Foot Screw.....
688J	22245	Pressure Regulating Thumb Screw.....
127095	22245	Rotating Hook with three 1253C.....
127096	22245	" " 127095 with 127102 and four 1053E.....
*127239	-----	Rotating Hook 127096 with 40274, 127242 and three 1367E.....
127097	-----	Rotating Hook 127096 with 40274 and three 1367E (For Agents Only)....
127240	22244	Rotating Hook 127239 with 52237.....
40264	22245	" " Bobbin.....
52235	22245	" " " Case.....
52236	-----	" " " " 52235 with 591F, 1380E and 40394.....
40392	22245	Rotating Hook Bobbin Case Latch.....
125320	22245	" " " " " Lever..
2974	22245	" " " " " " Fulcrum Pin.....
2975	22245	Rotating Hook Bobbin Case Latch Spring.....
592E	22245	" " " " " " Stop Screw.....
40393	-----	Rotating Hook Bobbin Case Hinge, Nos. 2974, 40392 and 125320.....
591F	22245	Rotating Hook Bobbin Case Tension Regulating Screw.....
40394	22245	Rotating Hook Bobbin Case Tension Spring.....

No.	Plate	Name
1380E	22245	Rotating Hook Bobbin Case Tension Spring Screw.....
52237	22245	Rotating Hook Bobbin Case complete, Nos. 592E, 2975, 40393 and 52236.....
127241	-----	Rotating Hook Bobbin Case 52237 with 127242.....
127242	22245	Rotating Hook Bobbin Case Holder.....
52018	22244	" " " " " Position Bracket.....
704J	22244	Rotating Hook Bobbin Case Holder Position Bracket Screw.....
40274	22245	Rotating Hook Section.....
1367E	22245	" " " Screw.....
1253C	22245	" " " Set Screw.....
127292	22244	" " " Shaft.....
127073	22244	" " " Bevel Gear with two 1259C.....
127007	22244	Rotating Hook Shaft Bevel Gear Case (two pieces) with 121E and 50234E..
50234E	22244	Rotating Hook Shaft Bevel Gear Case Plug Screw.....
121E	22244	Rotating Hook Shaft Bevel Gear Case Screw.....
1259C	22244	Rotating Hook Shaft Bevel Gear Set Screw.....
127004	22244	Rotating Hook Shaft Bushing (back)....
127043	-----	" " " " " 127004 with 52045.....
52045	22244	Rotating Hook Shaft Bushing (back) Packing (wick).....
1143C	22244	Rotating Hook Shaft Bushing (back) Set Screw.....
127005	22244	Rotating Hook Shaft Bushing (front)....
127044	-----	" " " " " 127005 with 52045.....
54897	22246	Rotating Hook Shaft Bushing (front) Oil Cup.....
52045	22244	Rotating Hook Shaft Bushing (front) Packing (wick).....
1148C	22244	Rotating Hook Shaft Bushing (front) Set Screw.....
127102	22245	Rotating Hook Thread Guard.....
1053E	22245	" " " " " Screw.....
52337	22245	Slack Thread Regulator.....
223C	22245	" " " Set Screw.....
2102	22243	Tension Disc.....
156CC	22243	" Regulating Thumb Nut.....
32572	22243	" Releasing Disc.....
43944	22243	" " " Lever.....

No.	Plate	Name
12398	22243	Tension Releasing Lever Hinge Pin.....
12329	22243	" " " Spring.....
32574	22243	" " " Pin.....
2103	22243	" Spring.....
50304C	22243	" Stud.....
52098	-----	" " 50304C with 1560C.....
50305C	22243	" " Set Screw.....
52397	22243	Tension complete, Nos.2103,32572,32574, 52083, 52098, 52394 and two 2102...
52027	22243	Thread Guard (side of arm).....
52454	22243	" Retainer.....
624C	22243	" " Set Screw.....
52215	-----	Thread Take-up complete, Nos. 11204, 52025 and 52217.....
52216	22245	Thread Take-up Crank.....
52217	-----	" " " 52216 with 775E and 52206.....
1037C	22242	Thread Take-up Crank Position Screw....
1036C	22242	" " " Set Screw.....
52022	22245	" " " Lever with 52130.....
52023	22245	" " " Hinge Pin.....
52024	22245	" " " Link.....
11204	22245	" " " " Hinge Pin....
435C	22245	" " " " " " Set Screw.....
52130	22245	Thread Take-up Lever Thread Eyelet Bushing.....
52025	-----	Thread Take-up Lever complete, Nos. 52022 to 52024.....
52394	22243	Thread Take-up Spring.....
52083	22243	" " " Regulator with 50305C.....
448C	22243	Thread Take-up Spring Regulator Set Screw.....
127106	22243	Throat Plate, large needle hole, for 127087.....
127107	-----	Throat Plate, small needle hole, for 127087.....
Note: Throat Plate No. 127106 is sent with this Ma- chine unless otherwise stated on order.		
691F	22243	Throat Plate Screw.....
44212	22910	Drip Pan with four 1 in. wire nails....
*15404	-----	Trade Mark.....
15405	-----	" " Rivet.....

## LIST OF PARTS

FOR

## MACHINE No. 96-46

For Cloaks, Clothing and Other Work in Cloth. Drop feed. Fitted with heavy gear shafts. The gears are lubricated with oil instead of grease. Speed up to 4000 R. P. M., according to the material being stitched.

THIS MACHINE IS THE SAME AS THE 96-40 MACHINE,  
WITH THE FOLLOWING EXCEPTIONS:

No.	Plate	Name
127221	-----	Arm Shaft (horizontal) 127047 with 52196 and 52246, in place of 127197
52462	22243	Feed Dog, 19 teeth (22 teeth to the inch) for 52463, in place of 127087
52246	22242	Needle Bar Crank with 1036C, 1037C and 1065C, in place of 127253.....
62527	22245	Presser Foot Hinge Pin, in place of 7298
24544	22245	" " Plate, in place of 19334..
24982	22245	" " Shank, in place of 19335..
26231	22245	" " Spring.....
24983	22245	Presser Foot (spring hinged) complete, Nos. 24544, 24982, 26231 and 62527, in place of 19336.....
52463	22243	Throat Plate for 52462, in place of 127106 and 127107.....

SINGER Needles should be used  
in SINGER Machines.  
These Needles and their Containers  
are marked with the  
Company's Trade Mark "SIMANCO.\*\*\*" 1

Needles in Containers marked  
"FOR SINGER MACHINES"  
are NOT **SINGER** made needles. 2



## ACCESSORIES

No.	Plate	Name
12361	22906	Machine Hinge Connection.....
44139	22906	" " Plate.....
44140	22906	Machine Hinge complete, Nos. 12361, 44139 and merlized wood screw 1 1/4 in. No. 14.....
20022	22906	Machine Rest (felt).....
41400	22906	" " Pin (wood).....
120342	22906	Oiler (copper plated) with 120343.....
120343	22906	" Spout, 3 1/2 in. long.....
26026	22906	Screw Driver (large).....
26485	22906	" " (small).....
8909	22906	Wrench for 1513 and 1518.....
8908	22906	" " 1519 and 1520.....

## BOBBIN WINDERS

## BOBBIN WINDER

(SWINGING AUTOMATIC, LEFT HAND)

No.	Plate	Name
41913	22247	Bracket with 457C.....
41583	22247	Frame with 457C.....
34105	22247	" Hinge Pin.....
457C	22247	" " " Set Screw.....
41914	22247	" Spring.....
41585	22247	Pulley with 171D.....
171D	22247	" Set Screw.....
41586	22247	Spindle.....
41587	22247	Stop Latch.....
42614	22247	" " Hinge Stud.....
457C	22247	" " " Set Screw.....
7958	22247	" " Stop Pin.....
41588	22247	" " Tripping Arm with 185H.....
185H	22247	" " " Clamping Screw.....
150459	22247	Tension Bracket with 460C.....
150460	22247	Tension Bracket complete, Nos. 41593 to 41595, 52183, 52239, 127187, 127255, 150459 and two 2455.....
127255	22247	Tension Bracket Positioning Disc.....
158J	22247	" " Screw.....
52239	22247	" " Spool Pin and Thread Eyelet.....
8879	22247	" " " Washer (cloth)....
2455	22247	" Disc.....
41593	22247	" Spring.....

No.	Plate	Name
41594	22247	Tension Stud.....
460C	22247	" " Set Screw.....
41595	22247	" Thread Guide.....
60845	22247	Bobbin Winder, Nos. 7958, 34105, 41583, 41585 to 41588, 41913, 41914 and 42614.....
41915	-----	Bobbin Winder 60845 with 880E and 25446
150461	22247	Bobbin Winder (swinging automatic, left hand) complete, Nos. 41915 and 150460.....
880E	22247	Bobbin Winder Screw.....
25446	22247	" " " Washer.....

## BOBBIN WINDER

(SWINGING AUTOMATIC, RIGHT HAND)

No.	Plate	Name
41339	22907	Base.....
41340	22907	Frame.....
1429D	22907	" Hinge Screw.....
41341	22907	" Spring.....
207D	22907	" " Screw.....
41342	22907	Pulley with 200F.....
200F	22907	" Set Screw.....
41343	22907	Spindle.....
27306	22907	Spool Pin.....
27307	22907	" Stand.....
27308	22907	Spool Stand complete, Nos. 418E, 1562J, 2106, 10141, 11241, 27306, 27307 and two each 2455 and wood screws 1 in. No. 10.....
11241	22907	Spool Washer (cloth).....
41344	22907	Stop Latch.....
41345	22907	" " Finger.....
152F	22907	" " " Screw.....
1430D	22907	" " Hinge Screw.....
1550H	22907	" " " Nut.....
41346	22907	" " Lever.....
1430D	22907	" " Hinge Screw.....
2455	22907	Tension Disc.....
1562J	22907	" " Regulating Thumb Nut.....
418E	22907	" " Screw Stud.....
10141	22907	" Spring.....
2106	22907	" Thread Guide.....

## BOBBIN WINDER

No.	Plate	Name
60456	-----	Bobbin Winder, Nos. 152F, 207D, 1429D, 1550H, 41339 to 41346 and three 1430D.....
41347	22907	Bobbin Winder, Nos. 60456 and two each 9331 and wood screws 1 in. No. 10 R.H.B.....
41348	22907	Bobbin Winder (swinging automatic, right hand) complete, Nos. 27308 and 41347
9331	22907	Bobbin Winder Washer.....

## BOBBIN WINDER

(SWINGING AUTOMATIC, RIGHT HAND)

## FOR POWER TABLE

No.	Plate	Name
225433	22908	Bobbin Winder and Tension Bracket Base.
225453	22908	Frame with 202277 and 225438.....
225454	22908	" Hinge Pin.....
202277	22908	" Oil Packing (wick).....
225438	22908	" Well Cap.....
225455	22908	" Spring.....
225456	22908	" Plunger.....
202473	22908	Pulley with 200380C.....
200380C	22908	" Set Screw.....
225381	22908	Spindle.....
225444	22908	Stop Latch.....
200056E	22908	" Screw.....
225458	22908	" Thumb Lever.....
225459	22908	" Hinge Stud.....
225459	22908	" Joint Stud.....
202478	22908	" Trip Lever.....
200299H	22908	" Hinge Screw.....
225461	22908	Tension Bracket with 201499B.....
200082D	22908	" Screw.....
228026	22908	" Washer.....
2102	22908	" Disc.....
202407	22908	" Spring.....
201499B	22908	" Stud.....
201572B	22908	" Thumb Nut.....
225462	22908	Tension Bracket complete, Nos. 201572B, 202407, 225461 and two 2102.....
225382	22908	Bobbin Winder complete, Nos. 200056E, 200082D, 200299H, 202473, 202478, 225381, 225433, 225444, 225453 to 225456, 225458, 225462, 228026, two each 225459 and wood screws 3/4 in. No. 12 R.H.B.....

## FOOT LIFTER PARTS

No.	Plate	Name
5596	22244	Bell Crank.....
56848	-----	" " 5596 with 5599 and 5601.....
5599	22244	Bell Crank Bracket.....
178E	22244	" " Screw.....
5601	22244	" Hinge Pin.....
5735	22244	" Spring.....
5598	-----	Bell Crank complete, Nos. 5735 and 56848
5670	22909	Chain, length 26 in. to 35 in. with 56864 and 56865.....
Note: When ordering No. 5670, state length required		
56864	22909	Chain Hook (large).....
56865	22909	" " (small).....
4879	22909	" Connecting Link.....
12237	22244	Lifting Lever with 448C.....
52028	22244	" Connecting Rod.....
12416	22244	" " " " Joint.....
76D	22244	" " " " Hinge Screw.....
1521E	22244	Lifting Lever Connecting Rod Lock Nut..
802D	22244	" Hinge Screw.....
12241	22245	" Link.....
766D	22245	" Hinge Screw.....
12240	22244	" Pin.....
448C	22244	" Set Screw.....
2763	22909	Rock Shaft.....
12242	22909	" Hanger with two wood screws 1 in. No. 10.....
6337	22909	Rock Shaft Lifting Bracket with two 356C.....
12243	22909	Rock Shaft Lifting Bracket Hook.....
7125	22909	" " " Hook.....
356C	22909	" " " Set Screw.....
356C	22909	" " " Set Screw...
277C	22909	" Stop Dog with 140219C.....
140219C	22909	" " " Set Screw.....
4880	22909	Rock Shaft complete, Nos. 2763, 2770, 7125, 12243 and two each 6337 and 12242.....
4881	22909	Treadle.....
4882	22909	" Shaft.....
4883	22909	" Spring.....
4884	22909	" Stand.....
4885	22909	Treadle complete, Nos. 4879, 4881 to 4884 and two wood screws 1 in. No. 16...
52319	-----	Foot Lifter complete, Nos. 76D, 766D, 802D, 1521E, 4880, 4885, 5598, 5670, 12237, 12240, 12241, 12416, 52028 and two 178E.....

## KNEE LIFTER PARTS

No.	Plate	Name
5596	22244	Bell Crank.....
56848	-----	" " 5596 with 5599 and 5601.....
5599	22244	" " Bracket.....
178E	22244	" " " Screw.....
5601	22244	" " Hinge Pin.....
5735	22244	" " Spring.....
5598	-----	Bell Crank complete, Nos.5735 and 56848
12237	22244	Lifting Lever with 448C.....
52028	22244	" " Connecting Rod.....
12416	22244	" " " " Joint.....
76D	22244	" " " " " Hinge Screw.....
1521E	22244	Lifting Lever Connecting Rod Lock Nut..
802D	22244	" " Hinge Screw.....
12241	22245	" " Link.....
766D	22245	" " " Hinge Screw.....
12240	22244	" " Pin.....
448C	22244	" " " Set Screw.....
2763	22910	Rock Shaft.....
7539	22910	" " Hanger with two wood screws 1 in. No. 10.....
2765	22910	Rock Shaft Knee Arm.....
2766	22910	" " " " Hub with 356C.....
356C	22910	" " " " " Set Screw.....
2768	-----	Rock Shaft Knee Arm complete, Nos. 2765 to 2767.....
2767	22910	Rock Shaft Knee Plate with 356C.....
356C	22910	" " " " " Set Screw.....
6337	22910	" " Lifting Bracket with two 356C
2778	22910	" " " " Hook.....
356C	22910	" " " " " Set Screw
356C	22910	" " " " " Set Screw....
2770	22910	" " Stop Dog with 140219C.....
140219C	22910	" " " " " Set Screw.....
12250	22910	Rock Shaft complete, Nos. 2763, 2768, 2778, 6337 and two each 2770 and 7539.....
52320	-----	Knee Lifter complete (power table) Nos. 76D, 766D, 802D, 1521E, 5598,12237, 12240,12241,12250,12416,52028 and two 178E.....

## MACHINE BASE

No.	Plate	Name
19219	22909	Bed Frame Cushion (leather).....
158C	22909	" " " Screw.....
19220	22909	" " " Spring.....
19226	22909	" " Hinge Connection.....
19398	-----	" " " " 19226 with 211E and 19397.....
19397	22909	Bed Frame Hinge Connection Cap.....
211E	22909	" " " " " Screw...
16555	22909	" " " " Plate.....
14010	22909	" " " " Rivet.....
20067	22909	" " with two each 16555,19398, four each 19219, 19220, six each 14010, wood screws 1 1/4 in. No. 12 and eight 158C.....

## THREAD UNWINDER

FOR TWO SPOOLS OR TWO LARGE CONES OF THREAD

No.	Plate	Name
225257	22248	Spool Rest with 201018C.....
150203	22248	" " Cushion (felt).....
225388	22248	" " Rod.....
200383C	22248	" " " Set Screw.....
201018C	22248	" " " Set Screw.....
202490	22248	" Stand with 200383C.....
225391	22248	Thread Guide.....
201696J	22248	" " Lock Nut.....
225326	22248	" " Position Cup.....
225324	22248	" " Rod with 208E and 225322..
208E	22248	" " " Screw.....
225322	22248	" " " Washer.....
225258	22248	Thread Unwinder complete, Nos. 201696J, 202490,225257,225324,225326,225388, two each 150203, 225391 and three wood screws 7/8 in. No. 12.....
27739	22248	Thread Cone (wood) for large cones....
225390	22248	" " Holder, for inverted cones.

Note: Nos. 27739 and 225390 are used with, but not included in 225258.

## NUMERICAL LIST OF PARTS

No.	Plate	Name
76D	22244	Lifting Lever Connecting Rod Joint Hinge Screw for 52319 and 52320....
116E	22246	Arm Screw (back).....
121E	22242	" Shaft (horizontal) Bevel Gear Case Screw for 127070.....
121E	22244	Rotating Hook Shaft Bevel Gear Case Screw for 127007.....
144D	22242	Arm Shaft (horizontal) Screw.....
152F	22907	Bobbin Winder Stop Latch Finger Screw for 60456.....
157J	22244	Feed Lifting Rock Shaft Crank Clamping Screw for 52265.....
157J	22244	Feed Rock Shaft Crank Clamping Screw for 29633.....
158J	22246	Arm Top Cover Screw.....
158C	22909	Bed Frame Cushion Screw for 20067.....
158J	22247	Bobbin Winder Tension Bracket Screw for 150460.....
171D	22247	Bobbin Winder Pulley Set Screw for 41585.....
176J	22243	Face Plate Screw.....
176J	22245	Presser Foot Screw.....
178E	22244	Bell Crank Bracket Screw for 52319 and 52320.....
185H	22247	Bobbin Winder Stop Latch Tripping Arm Clamping Screw for 41588.....
200F	22907	Bobbin Winder Pulley Set Screw for 41342.....
207D	22907	Bobbin Winder Frame Spring Screw for 60456.....
207E	22245	Needle Bar Connecting Stud Clamping Screw for 24041.....
208E	22248	Thread Unwinder Thread Guide Rod Screw for 225324.....
210J	22242	Balance Wheel Oil Cover Screw.....
211E	22909	Bed Frame Hinge Connection Cap Screw for 19398.....
219J	22244	Arm Side Cap Screw.....
223C	22245	Slack Thread Regulator Set Screw for 52338.....
226J	22243	Face Plate Thread Guard (lower) Screw for 52052.....
226J	22243	Face Plate Thread Guard (upper) Screw for 52052.....
229J	22245	Needle Bar Thread Guard Screw for 127116.....

**SINGER** Needles should be used  
 in **SINGER** Machines.  
 These Needles and their Containers  
 are marked with the  
 Company's Trade Mark "**SIMANCO**."\*\* 1

Needles in Containers marked  
 "**FOR SINGER MACHINES**"  
 are NOT **SINGER** made needles. 2

## NUMERICAL LIST OF PARTS

No.	Plate	Name
313C	22244	Feed Bar Screw Center for 56813.....
356C	22909	Rock Shaft Knee Arm Hub Set Screw for 2766.....
356C	22909	Rock Shaft Knee Plate Set Screw for 2767.....
356C	22909	Rock Shaft Lifting Bracket Hook Set Screw for 6337.....
356C	22909	Rock Shaft Lifting Bracket Set Screw for 6337.....
375C	22242	Feed Connecting Link Hinge Screw.....
375C	22242	" Forked Connection Hinge Screw for 52393.....
375C	22242	Feed Lifting Rock Shaft Connecting Rod Hinge Screw.....
418E	22907	Bobbin Winder Tension Disc Screw Stud for 27308.....
432C	22242	Arm Shaft (upright) Bushing (lower) Set Screw.....
435C	22242	Arm Shaft (horizontal) Flanged Bushing (front) Set Screw.....
435C	22242	Arm Shaft (upright) Bushing (upper) Set Screw.....
435C	22245	Thread Take-up Lever Link Hinge Pin Set Screw.....
448C	22242	Arm Shaft (horizontal) Flanged Bushing (back) Set Screw.....
448C	22242	Balance Wheel Set Screw for 52187.....
448C	22242	Feed and Feed Lifting Eccentric Set Screw for 127202.....
448C	22244	Lifting Lever Pin Set Screw for 12237..
448C	22243	Thread Take-up Spring Regulator Set Screw.....
453C	22245	Presser Bar Guide Bracket Set Screw for 52338.....
457C	22247	Bobbin Winder Frame Hinge Pin Set Screw for 41583.....
457C	22247	Bobbin Winder Stop Latch Hinge Stud Set Screw for 41913.....
460C	22247	Bobbin Winder Tension Stud Set Screw for 150459.....
591F	22245	Rotating Hook Bobbin Case Tension Regulating Screw for 52236.....
592E	22245	Rotating Hook Bobbin Case Latch Stop Screw for 52237.....
624C	22243	Thread Retainer Set Screw.....
688J	22245	Pressure Regulating Thumb Screw.....
689C	22245	Presser Bar Lifter Hinge Screw.....
691F	22243	Throat Plate Screw.....
704J	22244	Rotating Hook Bobbin Case Holder Position Bracket Screw.....

## NUMERICAL LIST OF PARTS

No.	Plate	Name
725J	22243	Bed Slide Spring Screw for 12432.....
766D	22245	Lifting Lever Link Hinge Screw for 52319 and 52320.....
775E	22245	Needle Bar Connecting Link Cap Screw for 52217.....
802D	22244	Lifting Lever Hinge Screw for 52319 and 52320.....
818D	22242	Feed Regulator Thumb Screw for 52093...
854E	22246	Arm Screw (front).....
880E	22247	Bobbin Winder Screw for 41915.....
966E	22242	Feed Lifting Rock Shaft Connecting Rod Cap Screw for 127156.....
1036C	22242	Arm Shaft (horizontal) Bevel Gear Set Screw for 127072.....
1036C	22242	Thread Take-up Crank Set Screw for 52246 and 127253.....
1037C	22242	Thread Take-up Crank Position Screw for 52246 and 127253.....
1053E	22245	Rotating Hook Thread Guard Screw for 127096.....
1065C	22242	Needle Bar Crank Position Screw for 52246 and 127253.....
1128E	22242	Feed Regulator Hinge Screw.....
1133E	22245	Needle Bar Bushing (lower) Set Screw...
1133E	22245	" " " (upper) Set Screw...
1143C	22244	Rotating Hook Shaft Bushing (back) Set Screw.....
1148C	22244	Rotating Hook Shaft Bushing (front) Set Screw.....
1253C	22245	Rotating Hook Set Screw for 127095.....
1259C	22242	Arm Shaft (upright) Bevel Gear (lower) Set Screw for 127073.....
1259C	22242	Arm Shaft (upright) Bevel Gear (upper) Set Screw for 127074.....
1259C	22244	Rotating Hook Shaft Bevel Gear Set Screw for 127073.....
1299C	22242	Feed and Feed Lifting Eccentric Position Screw for 127202.....
1367E	22245	Rotating Hook Section Screw for 127097 and 127239.....
1380E	22245	Rotating Hook Bobbin Case Tension Spring Screw for 52236.....
1429D	22907	Bobbin Winder Frame Hinge Screw for 60456.....
1430D	22907	Bobbin Winder Stop Latch Hinge Screw for 60456.....
1430D	22907	Bobbin Winder Stop Latch Lever Hinge Screw for 60456.....
1513J	22244	Feed Lifting Rock Shaft Screw Center Nut for 52097.....

## NUMERICAL LIST OF PARTS

No.	Plate	Name
1513J	22244	Feed Rock Shaft Screw Center Nut for 52097.....
1518J	22242	Feed Connecting Link Hinge Screw Nut...
1518E	22242	" Forked Connection Hinge Screw Nut for 52393.....
1518J	22242	Feed Lifting Rock Shaft Connecting Rod Hinge Screw Nut.....
1519J	22244	Feed Bar Screw Center Nut for 56813....
1520J	22245	Presser Bar Lifter Hinge Screw Nut....
1521E	22244	Lifting Lever Connecting Rod Lock Nut for 52319 and 52320.....
1550H	22907	Bobbin Winder Stop Latch Hinge Screw Nut for 60456.....
1560C	22243	Tension Regulating Thumb Nut for 52098.
1562J	22907	Bobbin Winder Tension Disc Regulating Thumb Nut for 27308.....
2102	22908	Bobbin Winder Tension Disc for 225462..
2102	22243	Tension Disc for 52397.....
2103	22243	" Spring for 52397.....
2106	22907	Bobbin Winder Tension Thread Guide for 27308.....
2455	22907	Bobbin Winder Tension Disc for 27308 and 150460.....
2763	22909	Rock Shaft for 4880 and 12250.....
2765	22910	" " Knee Arm for 2768.....
2766	22910	" " " Hub with 356C, for 2768.....
2767	22910	Rock Shaft Knee Plate with 356C, for 2768.....
2768	-----	Rock Shaft Knee Arm complete for 12250, Nos. 2765 to 2767.....
2770	22909	Rock Shaft Stop Dog with 140219C, for 4880 and 12250.....
2778	22910	Rock Shaft Lifting Bracket Hook for 12250.....
2974	22245	Rotating Hook Bobbin Case Latch Lever Fulcrum Pin for 40393.....
2975	22245	Rotating Hook Bobbin Case Latch Spring for 52237.....
4307	22243	Bed Slide Spring for 12432.....
4879	22909	Chain Connecting Link for 4885.....
4880	22909	Rock Shaft complete for 52319, Nos. 2763, 2770, 7125, 12243 and two each 6337 and 12242.....
4881	22909	Treadle for 4885.....
4882	22909	" Shaft for 4885.....
4883	22909	" Spring for 4885.....
4884	22909	" Stand for 4885.....
4885	22909	Treadle complete for 52319, Nos. 4879, 4881 to 4884 and two wood screws 1 in. No. 16.....

## NUMERICAL LIST OF PARTS

No.	Plate	Name
5596	22244	Bell Crank for 56848.....
5598	-----	Bell Crank complete for 52319 and 52320 Nos. 5735 and 56848.....
5599	22244	Bell Crank Bracket for 56848.....
5601	22244	" " Hinge Pin for 56848.....
5670	22909	Chain, length 26 in. to 35 in. with 56864 and 56865, for 52319.....
5735	22244	Bell Crank Spring for 5598.....
6337	22909	Rock Shaft Lifting Bracket with two 356C, for 4880 and 12250.....
7125	22909	Rock Shaft Lifting Bracket Hook for 4880.....
7298	22245	Presser Foot Hinge Pin for 19336.....
7539	22910	Rock Shaft Hanger with two wood screws 1 in. No. 10, for 12250.....
7958	22247	Bobbin Winder Stop Latch Stop Pin for 60845.....
8879	22246	Arm Spool Pin Washer (cloth).....
8879	22247	Bobbin Winder Tension Bracket Spool Pin Washer (cloth).....
8908	22906	Wrench for 1519 and 1520 (Accessories)
8909	22906	" " 1513 and 1518 (Accessories)
9331	22907	Bobbin Winder Washer for 41347.....
10141	22907	Bobbin Winder Tension Spring for 27308.
11170	22245	Presser Bar Spring Washer.....
11204	22245	Thread Take-up Lever Link Hinge Pin for 52215.....
11241	22907	Bobbin Winder Spool Washer (cloth) for 27308.....
12237	22244	Lifting Lever with 448C, for 52319 and 52320.....
12240	22244	Lifting Lever Pin for 52319 and 52320..
12241	22245	" " Link for 52319 and 52320.
12242	22909	Rock Shaft Hanger with two wood screws 1 in. No. 10, for 4880.....
12243	22909	Rock Shaft Lifting Bracket Hook for 4880.....
12250	22910	Rock Shaft complete for 52320, Nos. 2763, 2768, 2778, 6337 and two each 2770 and 7539.....
12327	22245	Presser Bar Lifting and Releasing Lever Bracket.....
12329	22243	Tension Releasing Lever Spring.....
12361	22906	Machine Hinge Connection for 44140....
12391	22245	Presser Bar (hollow).....
12398	22243	Tension Releasing Lever Hinge Pin.....
12416	22244	Lifting Lever Connecting Rod Joint for 52319 and 52320.....
12431	22243	Bed Slide for 12432.....

No.	Plate	Name
12432	22243	Bed Slide complete, Nos. 4307,12431 and two 725J.....
14010	22909	Bed Frame Hinge Plate Rivet for 20067..
*15404	-----	Trade Mark for 127213.....
15405	-----	" " Rivet for 127213.....
16532	22246	Arm Dowel Pin.....
16555	22909	Bed Frame Hinge Plate for 20067.....
19219	22909	" " Cushion (leather) for 20067..
19220	22909	" " Spring for 20067.....
19226	22909	" " Hinge Connection for 19398...
19334	22245	Presser Foot Plate for 19336.....
19335	22245	" " Shank for 19336.....
19336	22245	Presser Foot (hinged) complete for 96-40 Machine, Nos. 7298, 19334 and 19335.....
19397	22909	Bed Frame Hinge Connection Cap for 19398.....
19398	-----	Bed Frame Hinge Connection 19226 with 211E and 19397, for 20067.....
20022	22906	Machine Rest (felt) Accessories.....
20067	22909	Bed Frame with two each 16555, 19398, four each 19219, 19220, six each 14010, wood screws 1 1/4 in. No. 12 and eight 158C.....
20284	22242	Feed Forked Connection for 52393.....
24041	22245	Needle Bar Connecting Stud with 207E, for 52206.....
24544	22245	Presser Foot Plate for 24983.....
24982	22245	" " Shank for 24983.....
24983	22245	Presser Foot (spring hinged) complete for 96-46 Machine, Nos. 24544, 24982, 26231 and 62527.....
25446	22247	Bobbin Winder Screw Washer for 41915... Guide.....
25866	22246	Screw Driver (large) Accessories.....
26026	22906	Screw Driver (small) Accessories.....
26231	22245	Presser Foot Spring for 24983.....
26485	22906	Screw Driver (small) Accessories.....
27306	22907	Bobbin Winder Spool Pin for 27308.....
27307	22907	" " Stand for 27308....
27308	22907	Bobbin Winder Spool Stand complete for 41348, Nos. 418E, 1562J, 2106, 10141, 11241, 27306, 27307 and two each 2455 and wood screws 1 in. No. 10..
27739	22248	Thread Unwinder Thread Cone (wood) for large cones for 225258.....
29633	22244	Feed Rock Shaft Crank with 157J, for 52387.....
32572	22243	Tension Releasing Disc for 52397.....
32574	22243	" " Pin for 52397.....

No.	Plate	Name
34105	22247	Bobbin Winder Frame Hinge Pin for 60845
40264	22245	Rotating Hook Bobbin.....
40274	22245	" " Section for 127097 and 127239.....
40392	22245	Rotating Hook Bobbin Case Latch for 40393.....
40393	-----	Rotating Hook Bobbin Case Hinge for 52237, Nos. 2974, 40392 and 125320
40394	22245	Rotating Hook Bobbin Case Tension Spring for 52236.....
41339	22907	Bobbin Winder Base for 60456.....
41340	22907	" " Frame for 60456.....
41341	22907	" " Spring for 60456...
41342	22907	" " Pulley with 200F, for 60456
41343	22907	" " Spindle for 60456.....
41344	22907	" " Stop Latch for 60456.....
41345	22907	" " " " Finger for 60456
41346	22907	" " " " Lever for 60456
41347	22907	" " for 41348, Nos. 60456 and two each 9331 and wood screws 1 in. No. 10 R.H.B.....
41348	22907	Bobbin Winder (swinging automatic, right hand) complete, Nos. 27308 and 41347
41400	22906	Machine Rest Pin (wood) Accessories..
41583	22247	Bobbin Winder Frame with 457C, for 60845
41585	22247	" " Pulley with 171D, for 60845
41586	22247	" " Spindle for 60845.....
41587	22247	" " Stop Latch for 60845.....
41588	22247	" " " " Tripping Arm with 185H, for 60845.....
41593	22247	Bobbin Winder Tension Spring for 150460
41594	22247	" " Stud for 150460..
41595	22247	" " Thread Guide for 150460.....
41913	22247	Bobbin Winder Bracket with 457C, for 60845.....
41914	22247	Bobbin Winder Frame Spring for 60845...
41915	-----	" " 60845 with 880E and 25446, for 150461.....
42367	22246	Arm Oil Tube Packing (braided cotton) for 52185 and 127187.....
42614	22247	Bobbin Winder Stop Latch Hinge Stud for 60845.....
43944	22243	Tension Releasing Lever.....
44139	22906	Machine Hinge Plate for 44140.....
44140	22906	Machine Hinge complete, Nos. 12361, 44139 and merlized wood screw 1 1/4 in. No. 14 (Accessories).....
44212	22910	Drip Pan with four 1 in. wire nails....

## NUMERICAL LIST OF PARTS

No.	Plate	Name
52205	22245	Needle Bar Connecting Link with 52207, for 52206.....
52206	-----	Needle Bar Connecting Link 52205 with 24041, for 52217.....
52207	-----	Needle Bar Connecting Link Lubricating Pad (wood) for 52205.....
52210	-----	Feed and Feed Lifting Eccentric Lubricating Pad (long) wood for 127202..
52211	-----	Feed and Feed Lifting Eccentric Lubricating Pad (short) wood for 127202.
52215	-----	Thread Take-up complete, Nos. 11204, 52025 and 52217.....
52216	22245	Thread Take-up Crank for 52217.....
52217	-----	" " " 52216 with 775E and 52206, for 52215.....
52235	22245	Rotating Hook Bobbin Case for 52236....
52236	-----	" " " " 52235 with 591F, 1380E and 40394, for 52237...
52237	22245	Rotating Hook Bobbin Case complete for 127240 and 127241, Nos. 592E, 2975, 40393 and 52236.....
52239	22246	Arm Spool Pin and Thread Eyelet for 127193.....
52239	22247	Bobbin Winder Tension Bracket Spool Pin and Thread Eyelet for 150460.....
52246	22242	Needle Bar Crank with 1036C, 1037C and 1065C, for 127221.....
52265	22244	Feed Lifting Rock Shaft Crank 52271 with 157J and 52267, for 127269....
52266	-----	Feed Lifting Rock Shaft Crank Slide Block for 52267.....
52267	22244	Feed Lifting Rock Shaft Crank Slide Block 52266 with 125060, for 52265.
*52271	-----	Feed Lifting Rock Shaft Crank for 52265
52306	22245	Needle Bar Thread Guard for 127116.....
52307	22245	" Clamp with 51460F, for 127116...
52319	-----	Foot Lifter complete, Nos. 76D, 766D, 802D, 1521E, 4880, 4885, 5598, 5670, 12237, 12240, 12241, 12416, 52028 and two 178E
52320	-----	Knee Lifter complete (power table) Nos. 76D, 766D, 802D, 1521E, 5598, 12237, 12240, 12241, 12250, 12416, 52028 and two 178E.....
52337	22245	Slack Thread Regulator.....
52338	22245	Presser Bar Guide Bracket with 223C and 453C.....
*52383	-----	Bed.....
52384	22244	Feed Lifting Rock Shaft for 127269.....

## NUMERICAL LIST OF PARTS

No.	Plate	Name
52386	22244	Feed Rock Shaft for 52387.....
52387	-----	Feed Rock Shaft complete, Nos. 29633 and 52386.....
52393	-----	Feed Forked Connection 20284 with 375C, 1518J and 52165.....
52394	22243	Thread Take-up Spring for 52397.....
52397	22243	Tension complete, Nos. 2103, 32572, 32574, 52083, 52098, 52394 and two 2102...
52452	22244	Feed Bar.....
52454	22243	Thread Retainer.....
52462	22243	Feed Dog, 19 teeth (22 teeth to the inch) for 52463, for 96-46 Machine.
52463	22243	Throat Plate for 52462, for 96-46 Machine.....
52492	22242	Arm Shaft (upright) Bushing (lower)....
52493	22242	" " " " (upper)....
54897	22246	Rotating Hook Shaft Bushing (front) Oil Cup.....
56015	22246	Arm Oil Tube for oiling 127058, for 127213.....
56813	-----	Feed Bar Screw Center 313C with 1519J..
56848	-----	Bell Crank 5596 with 5599 and 5601, for 5598.....
56864	22909	Chain Hook (large) for 5670.....
56865	22909	" " (small) for 5670.....
60456	-----	Bobbin Winder for 41347, Nos. 152F, 207D, 1429D, 1550H, 41339 to 41346 and three 1430D.....
60845	22247	Bobbin Winder for 41915, Nos. 7958, 34105, 41583, 41585 to 41588, 41913, 41914 and 42614.....
62527	22245	Presser Foot Hinge Pin for 24983.....
68350	22246	Arm Shaft (horizontal) Front Bearing Oil Cup.....
120342	22906	Oiler (copper plated) with 120343 (Accessories).....
120343	22906	Oiler Spout, 3 1/2 in. long for 120342.
*125060	-----	Feed Lifting Rock Shaft Crank Slide Block Stud for 52267.....
125320	22245	Rotating Hook Bobbin Case Latch Lever for 40393.....
127004	22244	Rotating Hook Shaft Bushing (back) for 127043.....
127005	22244	Rotating Hook Shaft Bushing (front) for 127044.....
127007	22244	Rotating Hook Shaft Bevel Gear Case (two pieces) with 121E and 50234E..
127043	-----	Rotating Hook Shaft Bushing (back) 127004 with 52045.....



## NUMERICAL LIST OF PARTS

No.	Plate	Name
127044	-----	Rotating Hook Shaft Bushing (front) 127005 with 52045.....
127047	22242	Arm Shaft (horizontal) for 127197 and 127221.....
127058	22242	Arm Shaft (upright).....
127070	22242	" " (horizontal) Bevel Gear Case (two pieces) with 121E.....
127072	22242	Arm Shaft (horizontal) Bevel Gear with two 1036C.....
127073	22242	Arm Shaft (upright) Bevel Gear (lower) with two 1259C.....
127073	22244	Rotating Hook Shaft Bevel Gear with two 1259C.....
127074	22242	Arm Shaft (upright) Bevel Gear (upper) with two 1259C.....
127079	22246	Arm Side Cover.....
127087	22243	Feed Dog for general work, 19 teeth (16 teeth to the inch) for 127106 and 127107, for 96-40 Machine.....
127088	22245	Needle Bar (hollow) for 127116.....
127091	22246	Oil Tube Bracket for 127092.....
127092	22246	" " 127091 with 127191, for oiling Feed Connecting Link.....
127095	22245	Rotating Hook with three 1253C, for 127096.....
127096	22245	Rotating Hook 127095 with 127102 and four 1053E, for 127097 and 127239..
127097	-----	Rotating Hook 127096 with 40274 and three 1367E (For Agents only)....
127102	22245	Rotating Hook Thread Guard for 127096..
127106	22243	Throat Plate, large needle hole, for 127087, for 96-40 Machine.....
127107	-----	Throat Plate, small needle hole, for 127087, for 96-40 Machine.....
127108	22245	Presser Bar Spring.....
127116	-----	Needle Bar 127088 with 229J, 52306 and 52307.....
127146	22244	Arm Side Cap.....
127152	22242	Feed and Feed Lifting Eccentric Sleeve.
127156	22242	" Lifting Rock Shaft Connecting Rod with two 966E.....
127187	22246	Arm Oil Tube (bent) with 42367, for oiling 127152, for 127193 and 150460
127191	22246	Oil Tube with 52184, for 127092.....
127192	22246	Arm Top Cover for 127193.....
127193	-----	" " " 127192 with 52183, 52239, 127187 and 127255.....
127197	-----	Arm Shaft (horizontal) 127047 with 52196 and 127253, for 96-40 Machine

## NUMERICAL LIST OF PARTS

No.	Plate	Name
127202	22242	Feed and Feed Lifting Eccentric with 448C, 1299C, 52210 and 52211.....
*127213	-----	Arm with 15404 and two each 15405 and 56015.....
127221	-----	Arm Shaft (horizontal) 127047 with 52196 and 52246, for 96-46 Machine.
127230	22245	Needle Bar Bushing (lower).....
*127239	-----	Rotating Hook 127096 with 40274, 127242 and three 1367D, for 127240.....
127240	22244	Rotating Hook 127239 with 52237.....
127241	-----	" " Bobbin Case 52237 with 127242.....
127242	22245	Rotating Hook Bobbin Case Holder for 127239 and 127241.....
127253	22242	Needle Bar Crank with 1036C, 1037C and 1065C, for 127197.....
127255	22246	Arm Top Cover Positioning Disc for 127193.....
127255	22247	bobbin Winder Tension Bracket Positioning Disc for 150460.....
127269	-----	Feed Lifting Rock Shaft complete, Nos. 52265 and 52384.....
127292	22244	Rotating Hook Shaft.....
140219C	22909	Rock Shaft Stop Dog Set Screw for 2770.
150203	22248	Thread Unwinder Spool Rest Cushion (felt) for 225258.....
150459	22247	Bobbin Winder Tension Bracket with 460C, for 150460.....
150460	22247	Bobbin Winder Tension Bracket complete for 150461, Nos. 41593 to 41595, 52183, 52239, 127197, 127255, 150459 and two 2455.....
150461	22247	Bobbin Winder (swinging automatic, left hand) complete, Nos. 41915 and 150460.....
200056E	22908	Bobbin Winder Stop Latch Screw for 225382.....
200082D	22908	Bobbin Winder Tension Bracket Screw for 225382.....
200299H	22908	Bobbin Winder Stop Latch Trip Lever Hinge Screw for 225382.....
200380C	22908	Bobbin Winder Pulley Set Screw for 202473.....
200383C	22248	Thread Unwinder Spool Rest Rod Set Screw for 202490.....
201019C	22248	Thread Unwinder Spool Rest Set Screw for 225257.....
201499B	22908	Bobbin Winder Tension Stud for 225461..
201572B	22908	" " " " Thumb Nut for 225462.....

## NUMERICAL LIST OF PARTS

No.	Plate	Name
201696J	22248	Thread Unwinder Thread Guide Lock Nut for 225258.....
202277	22908	Bobbin Winder Frame Oil Packing (wick) for 225453.....
202407	22908	Bobbin Winder Tension Spring for 225462
202473	22908	" " Pulley with 200380C, for 225382.....
202478	22908	Bobbin Winder Stop Latch Trip Lever for 225382.....
202490	22248	Thread Unwinder Spool Stand with 200383C, for 225258.....
225257	22248	Thread Unwinder Spool Rest with 201018C, for 225258.....
225258	22248	Thread Unwinder complete (for two spools) Nos. 201696J, 202490, 225257, 225324, 225326, 225388, two each 150203, 225391 and three wood screws 7/8 in. No. 12.....
225322	22248	Thread Unwinder Thread Guide Rod Washer for 225324.....
225324	22248	Thread Unwinder Thread Guide Rod with 208E and 225322, for 225258.....
225326	22248	Thread Unwinder Thread Guide Position Cup for 225258.....
225381	22908	Bobbin Winder Spindle for 225382.....
225382	22908	Bobbin Winder (swinging automatic, right hand) complete for power table, Nos. 200056E, 200082D, 200299H, 202473, 202478, 225381, 225433, 225444, 225453 to 225456, 225458, 225462, 228026, two each 225459 and wood screws 3/4 in. No. 12 R.H.B.....
225388	22248	Thread Unwinder Spool Rest Rod for 225258.....
225390	22248	Thread Unwinder Thread Cone Holder, for inverted cones, for 225258.....
225391	22248	Thread Unwinder Thread Guide for 225258
225433	22908	Bobbin Winder and Tension Bracket Base for 225382.....
225438	22908	Bobbin Winder Frame Oil Well Cap for 225453.....
225444	22908	Bobbin Winder Stop Latch for 225382....
225453	22908	" " Frame with 202277 and 225438, for 225382.....
225454	22908	Bobbin Winder Frame Hinge Pin for 225382.....
225455	22908	Bobbin Winder Frame Spring for 225382..
225456	22908	" " " " Plunger for 225382.....

## NUMERICAL LIST OF PARTS

No.	Plate	Name
225458	22908	Bobbin Winder Stop Latch Thumb Lever for 225382.....
225459	22908	Bobbin Winder Stop Latch Thumb Lever Hinge Stud for 225382.....
225459	22908	Bobbin Winder Stop Latch Thumb Lever Joint Stud for 225382.....
225461	22908	Bobbin Winder Tension Bracket with 201499B, for 225462.....
225462	22908	Bobbin Winder Tension Bracket complete for 225382, Nos. 201572B, 202407, 225461 and two 2102.....
228026	22908	Bobbin Winder Tension Bracket Screw Washer for 225382.....

SINGER Needles should be used  
in SINGER Machines.  
These Needles and their Containers  
are marked with the  
Company's Trade Mark "SIMANCO.™" 1

Needles in Containers marked  
"FOR SINGER MACHINES"  
are NOT **SINGER** made needles. 2

SINGER Needles should be used  
 in SINGER Machines.  
 These Needles and their Containers  
 are marked with the  
 Company's Trade Mark "SIMANCO."<sup>4,5</sup> 1

Needles in Containers marked  
 "FOR SINGER MACHINES"  
 are NOT **SINGER** made needles. 2

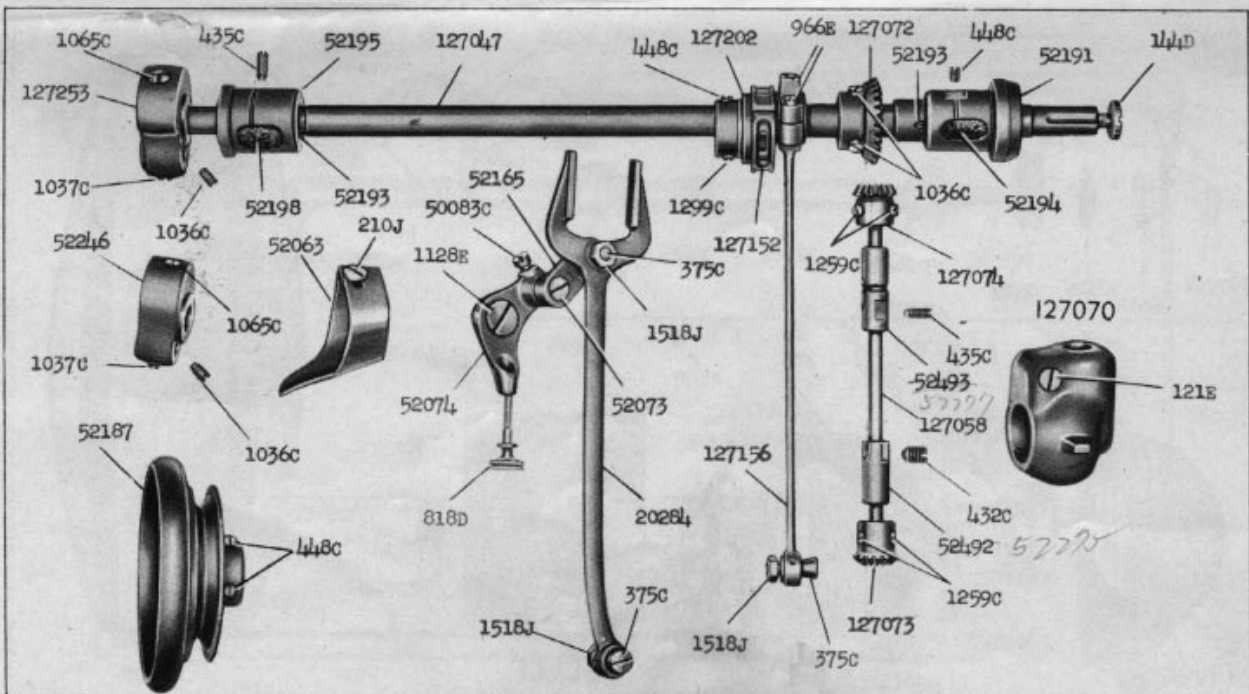

22242 - 1/3

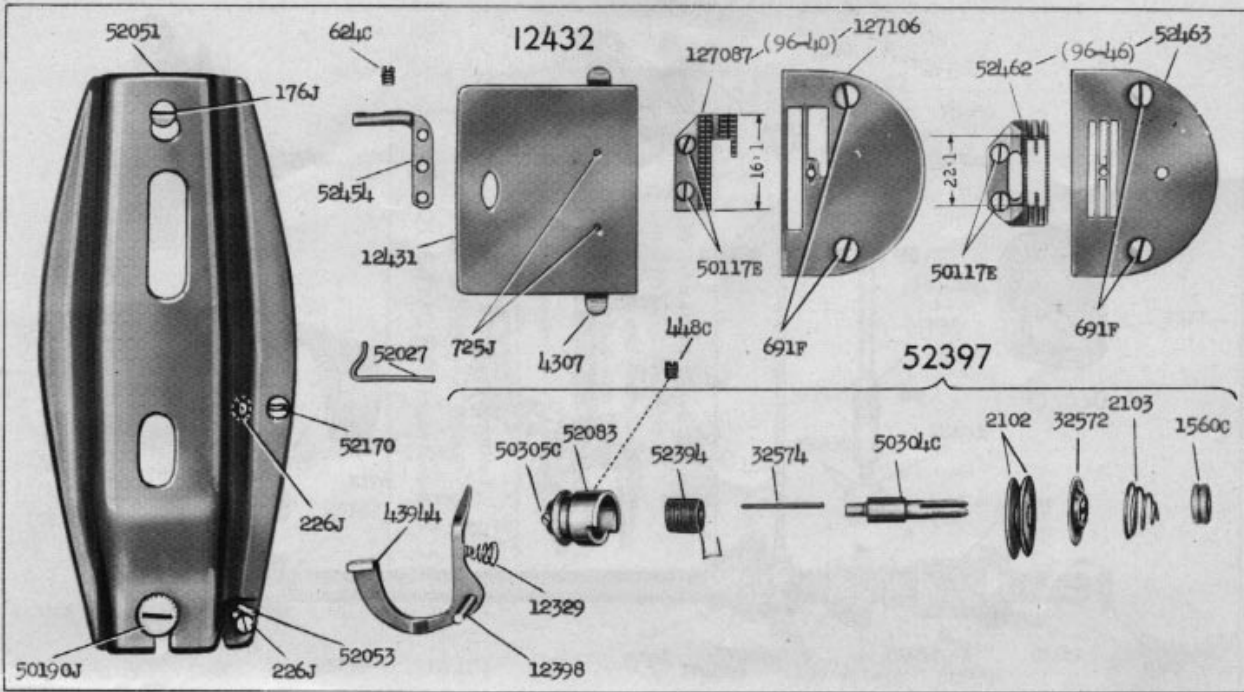

22243 - 1/2

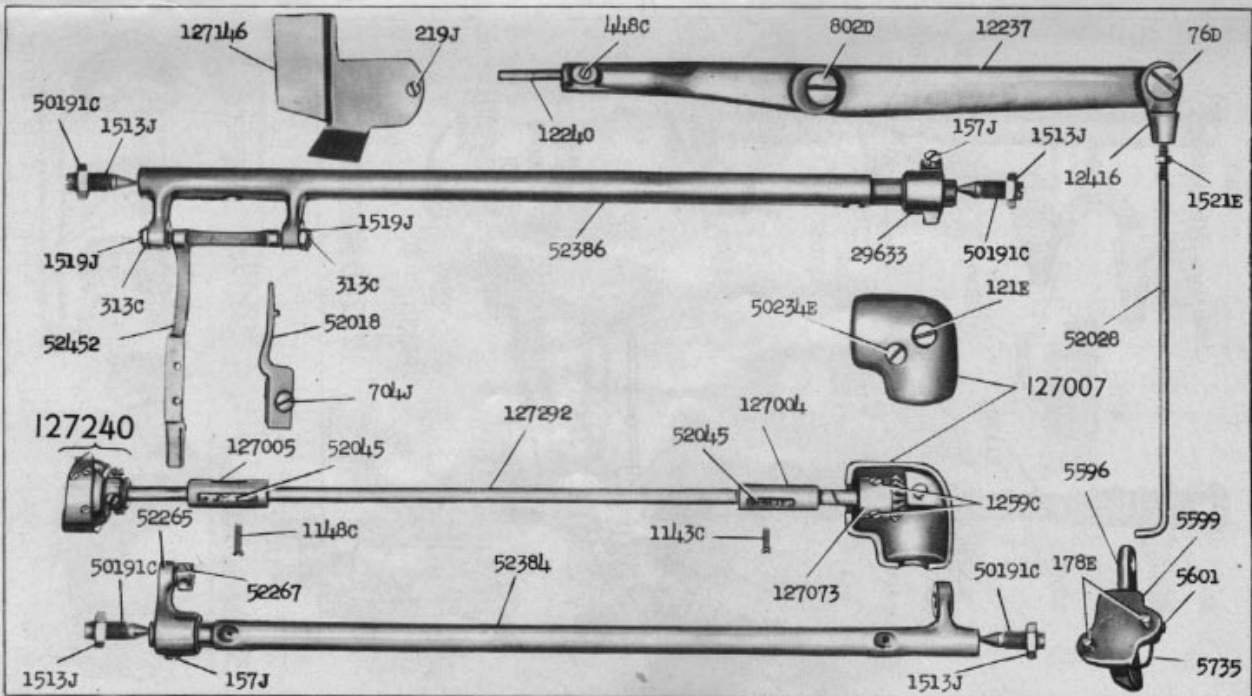

22244 - 1/3

22245 - 1/2

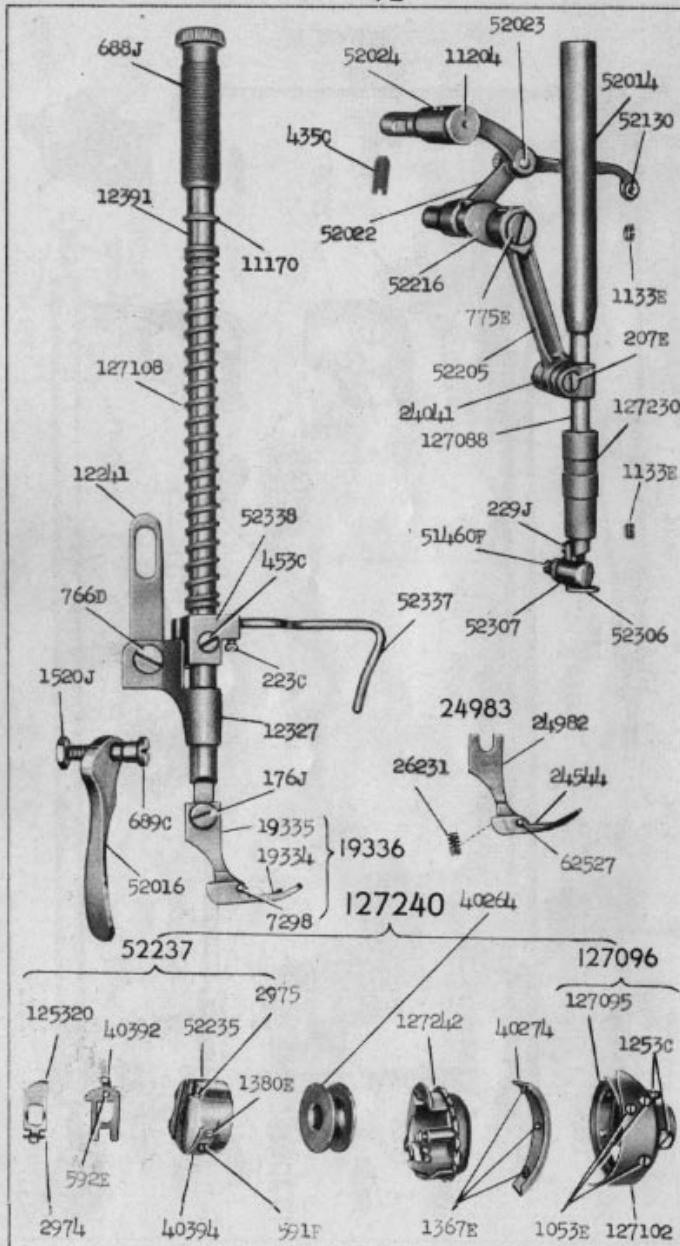



22247 - 1/2

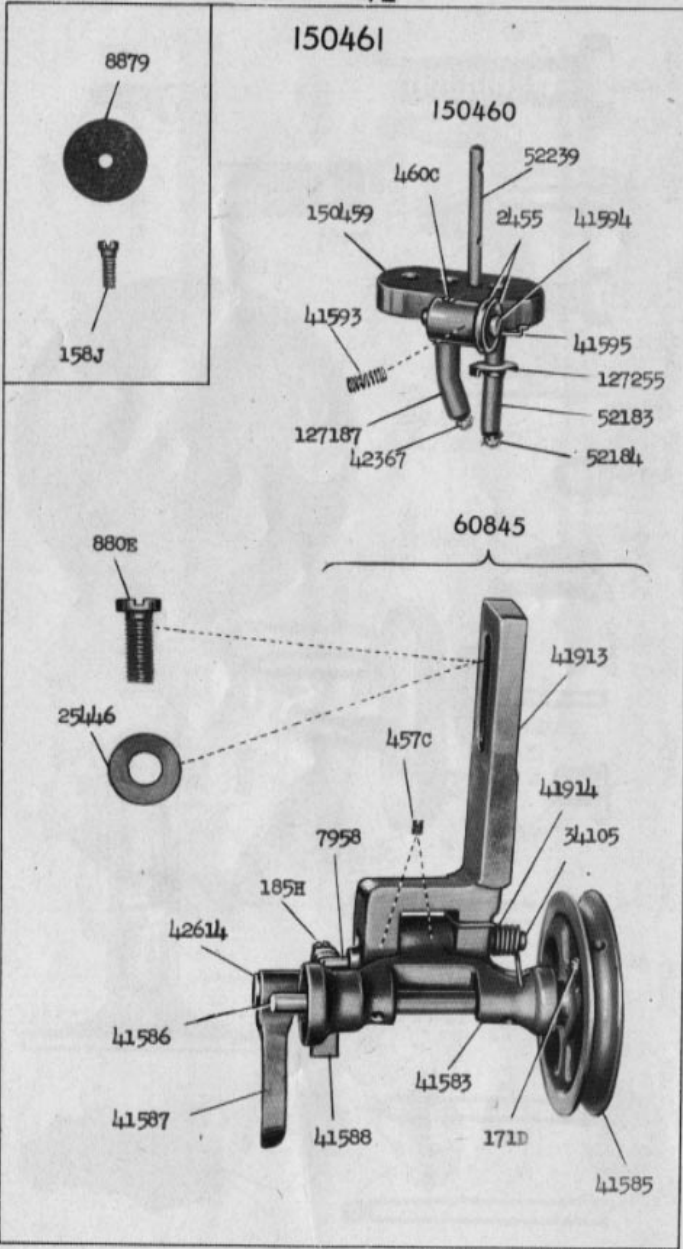

22248 - 1/6

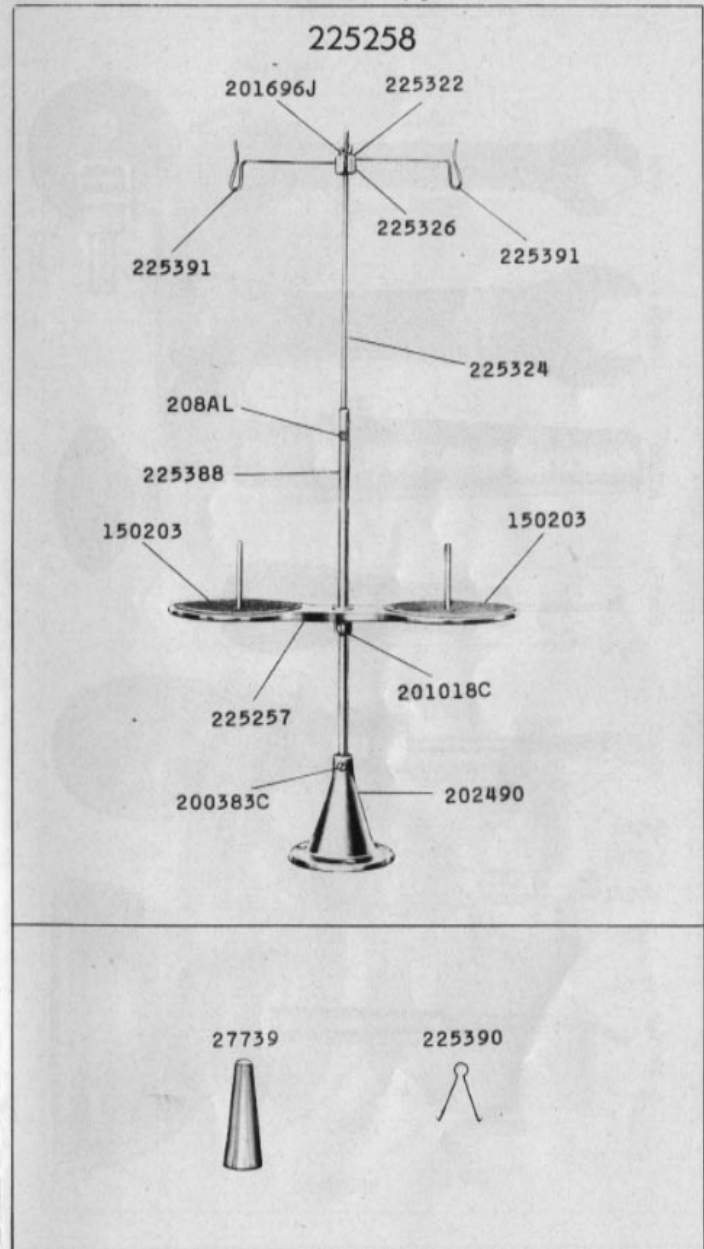

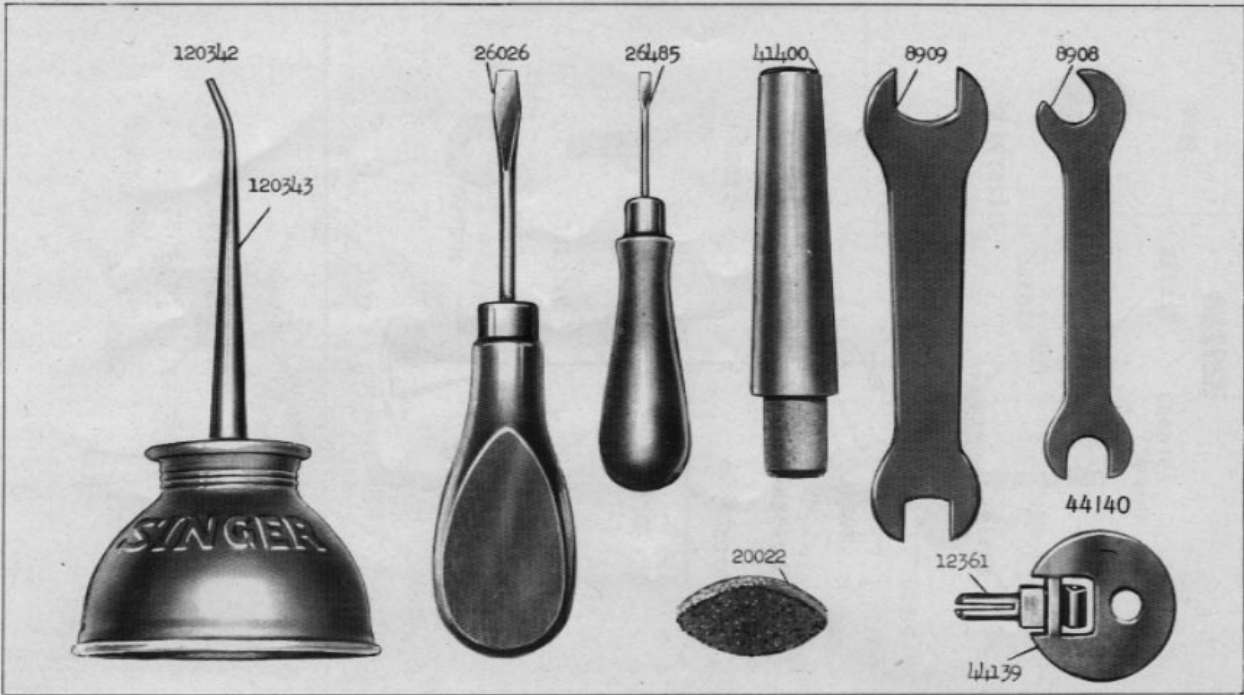

22906 - 1/2



22907 - 2/3

41348

27308

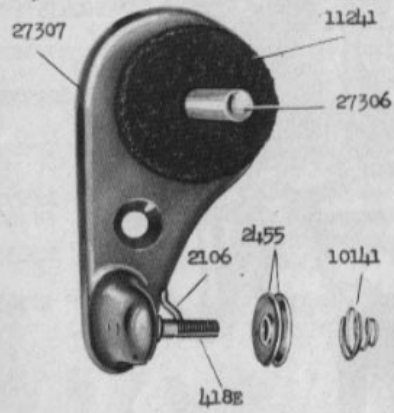

41347

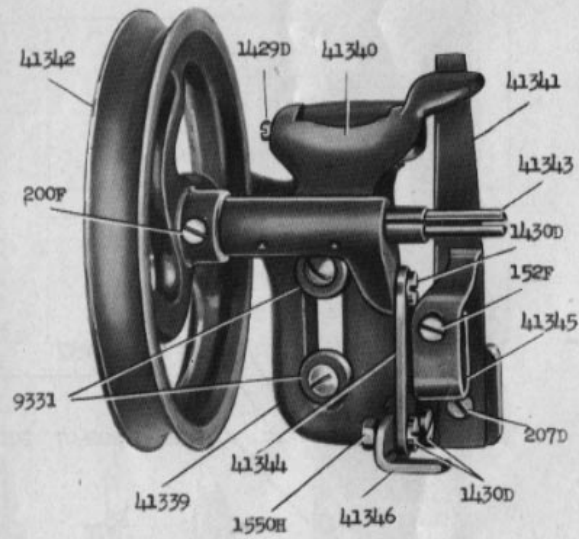

22908 - 1/2

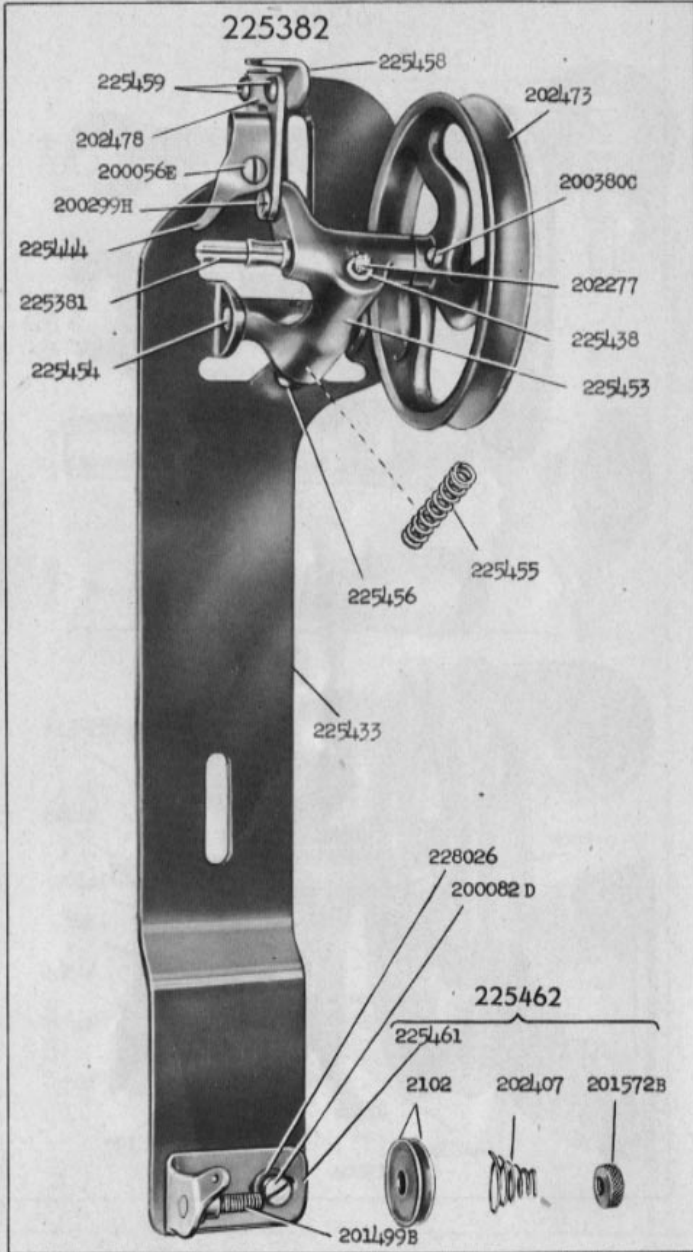

22909 - 1/4

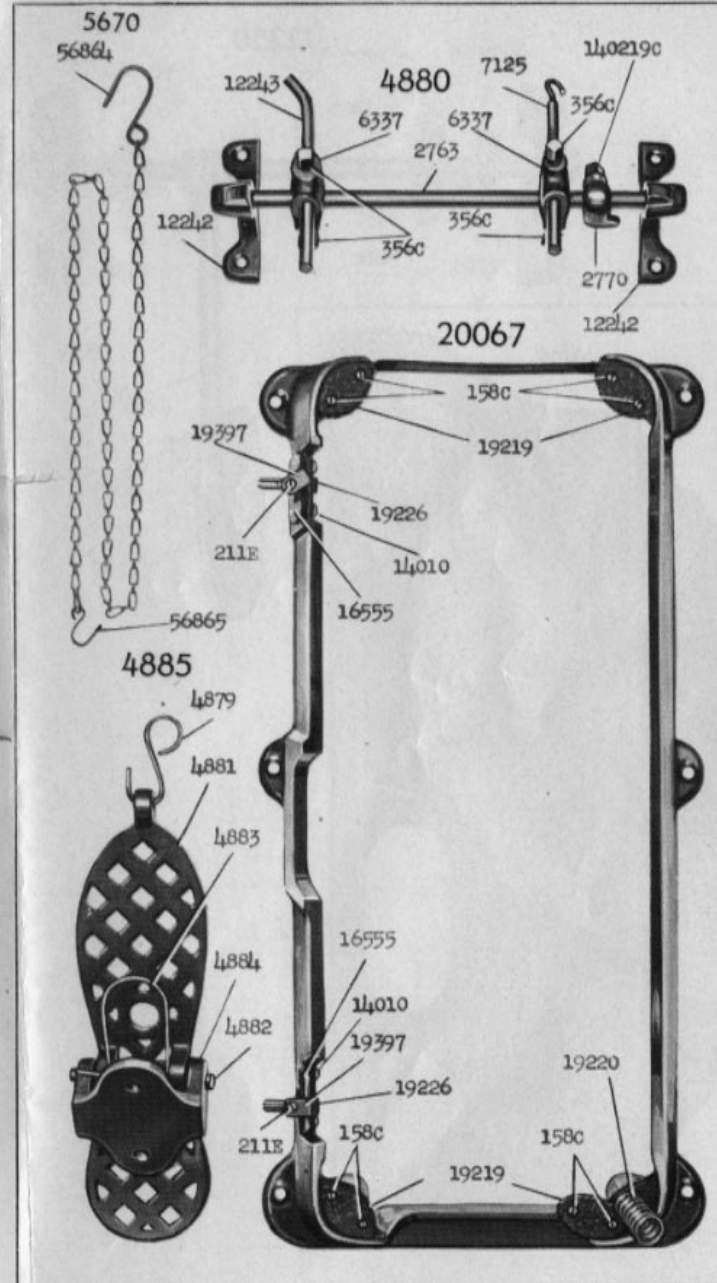

22910 - 1/4

