

**SINGER**  
**96K40,K45,K49,K51**

Form K5990  
(Supersedes K5793)

# ILLUSTRATED LIST OF PARTS

FOR

Nos. 96K40 to 96K45,

96K49 and 96K51

## MACHINES

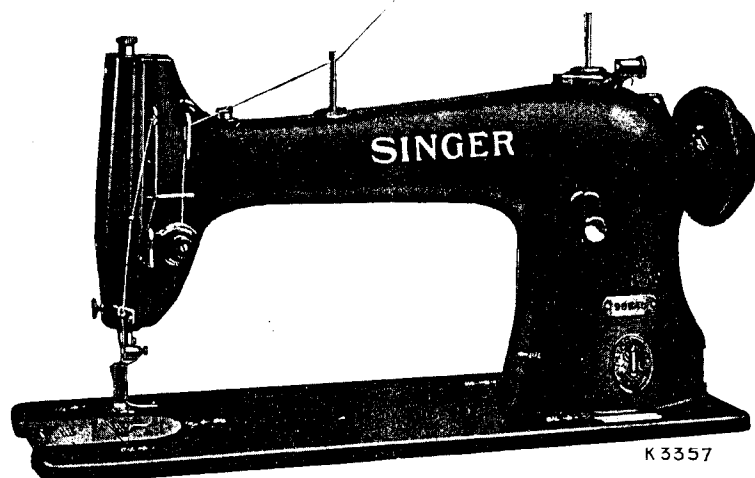

No. 96K51 Machine

\*\* A Trade Mark of  
THE SINGER MANUFACTURING COMPANY

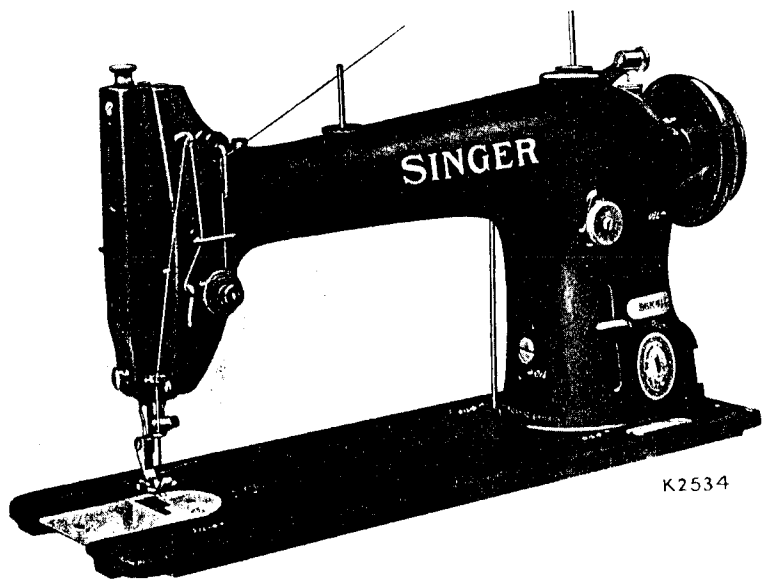

K2534

No. 96K41 Machine

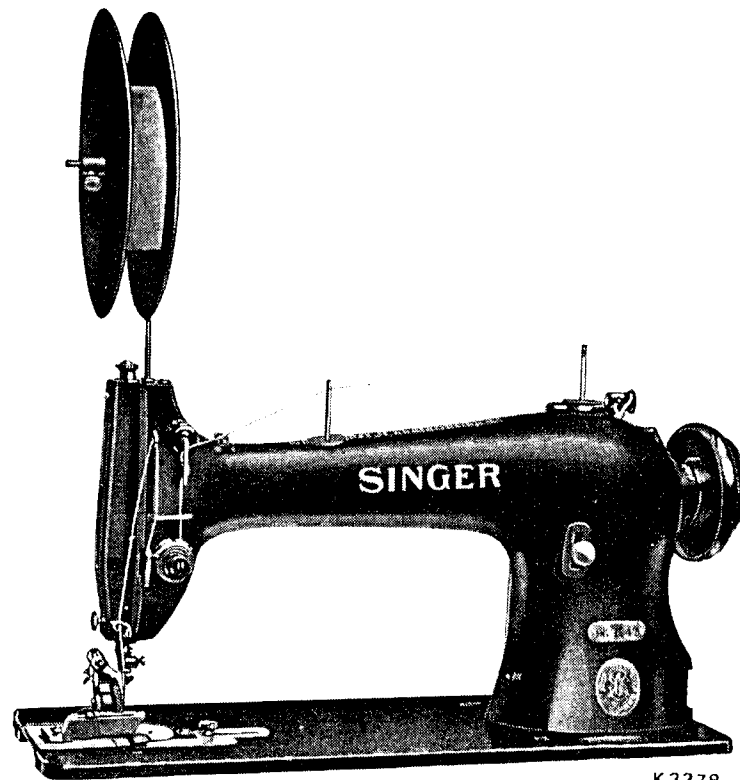

K3378

No. 96K43 Machine

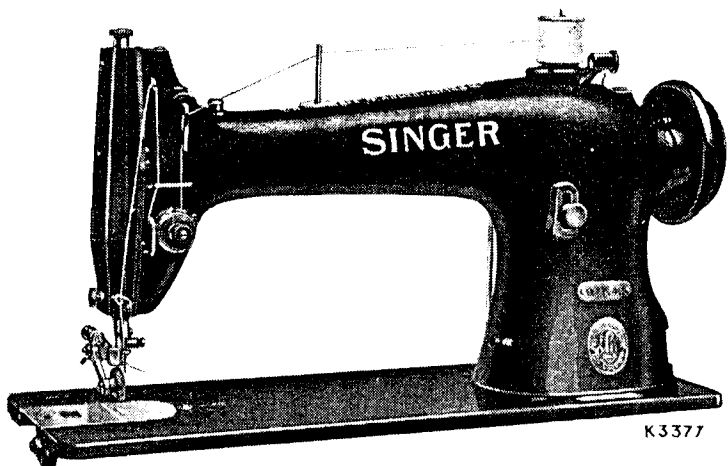

K3377

No. 96K42 Machine

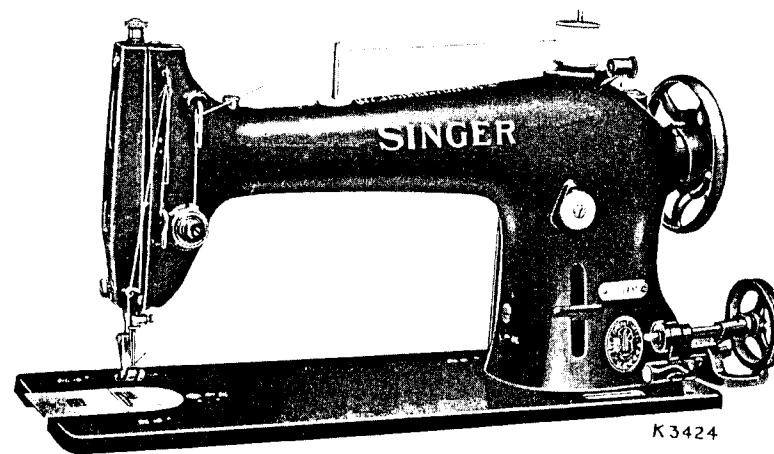

K3424

No. 96K44 Machine

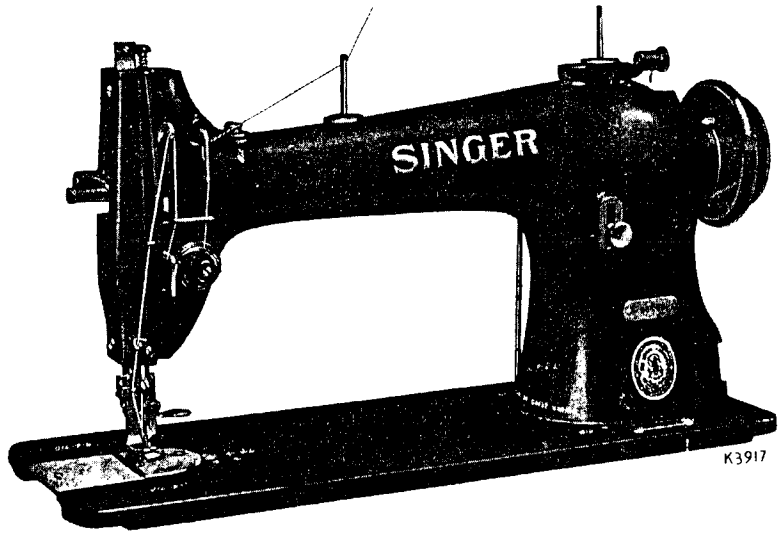

No. 96K45 Machine

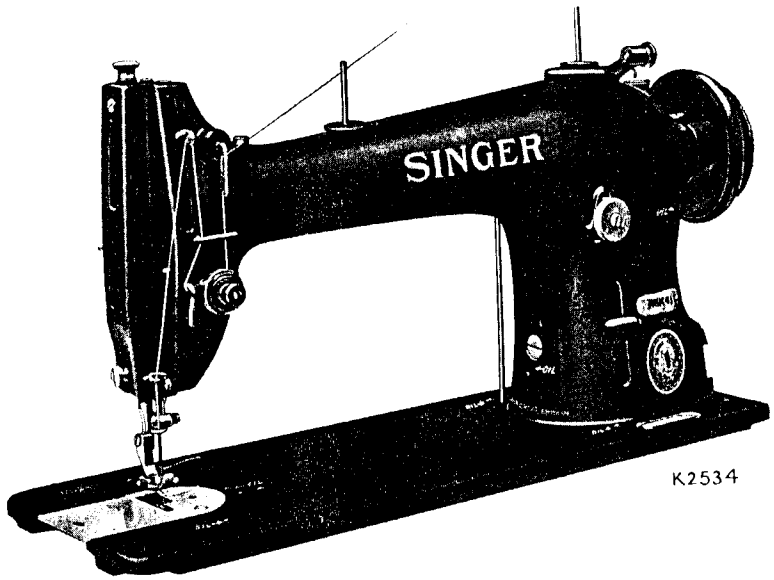

No. 96K49 Machine

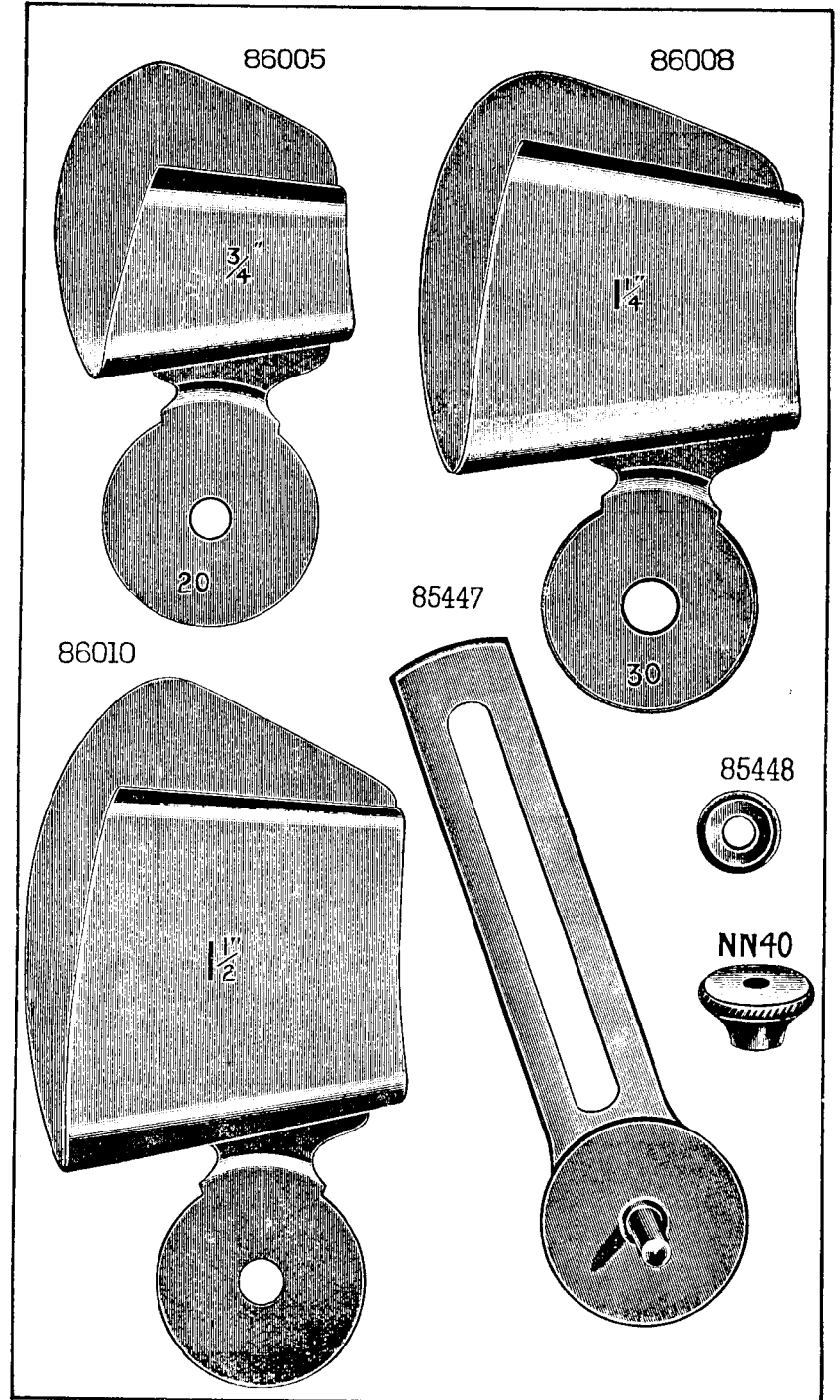

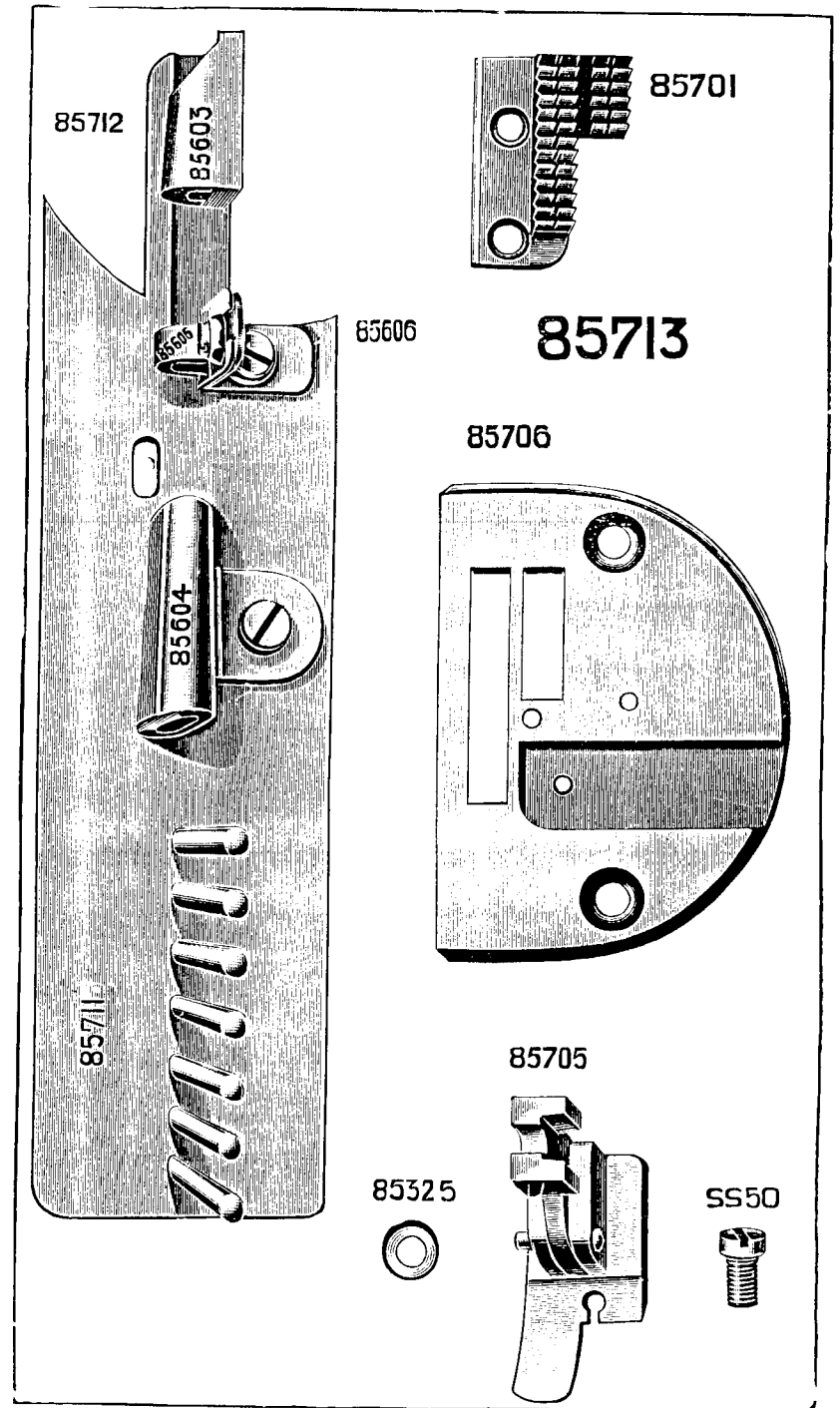
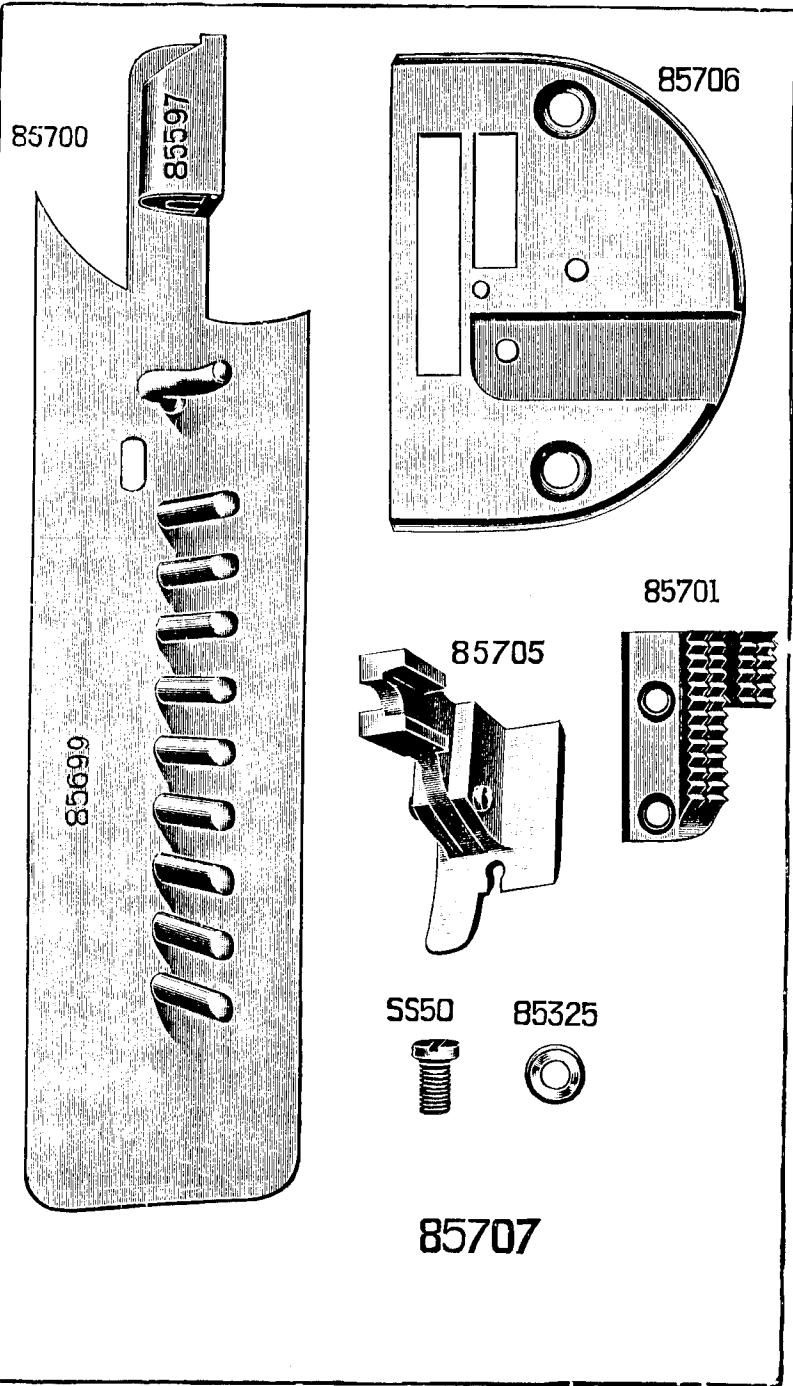

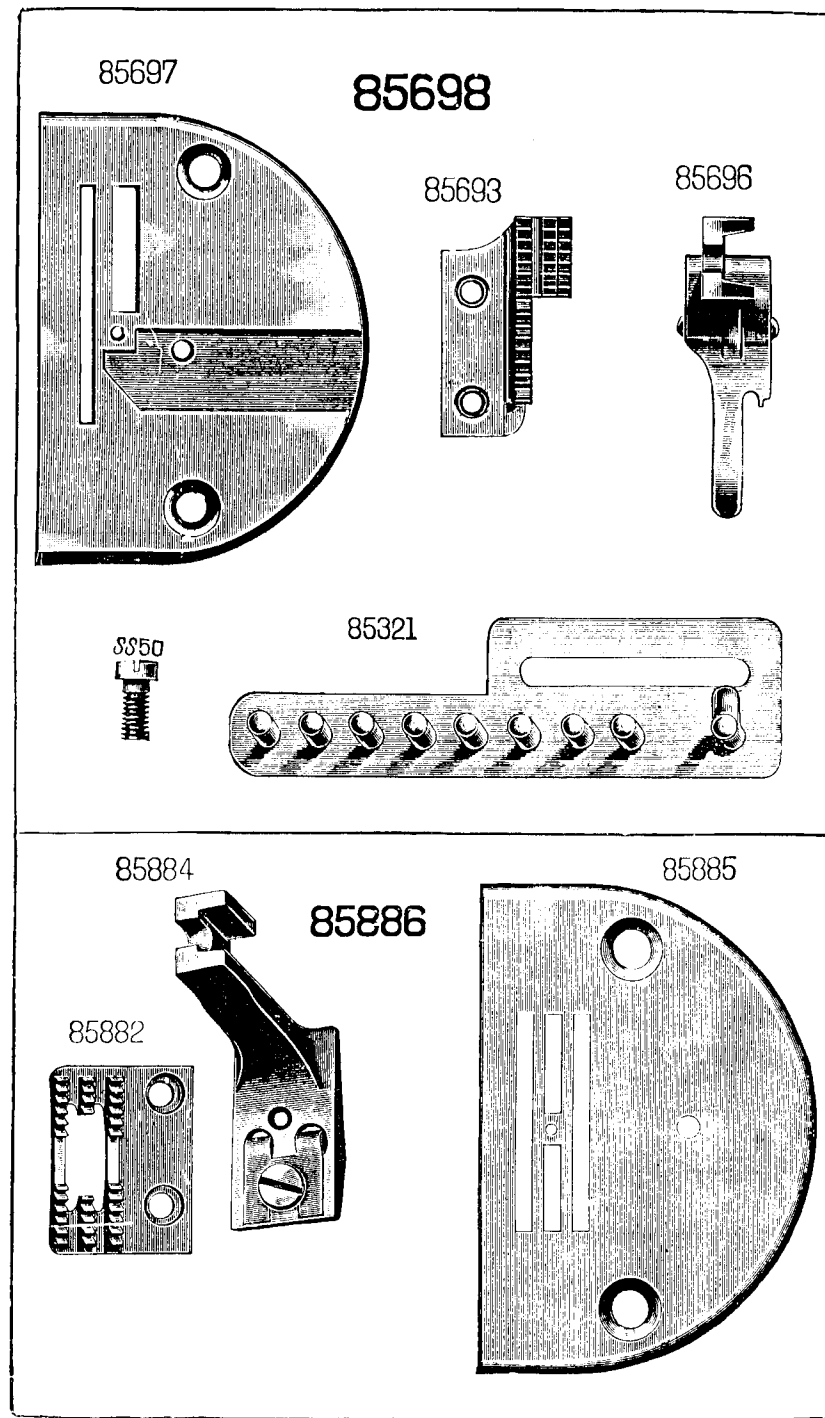
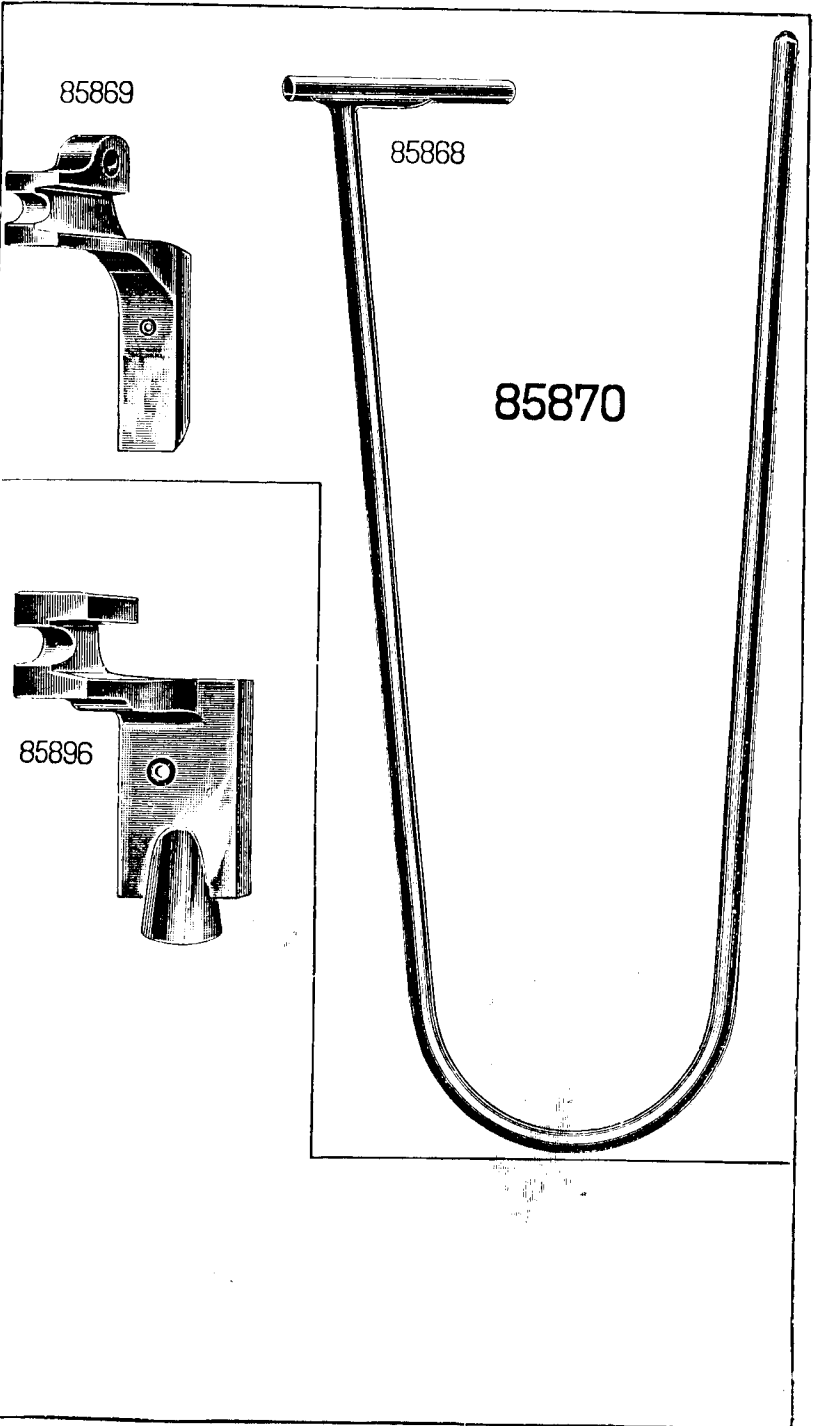

85691

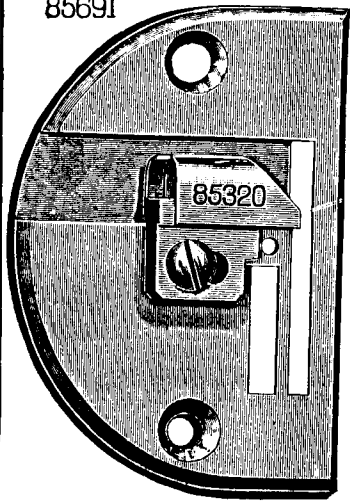

85686

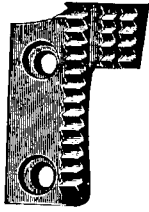

85321

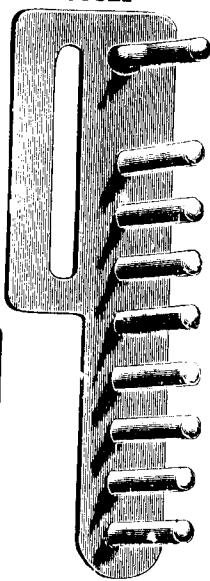

85692

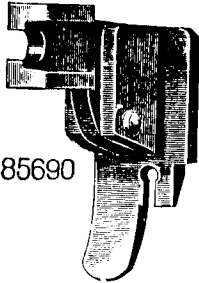

85690

85684

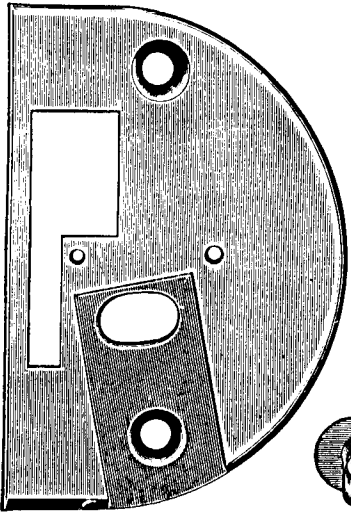

85685

85682

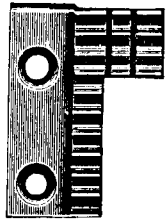

85683



85339

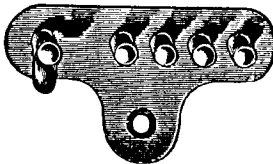

85325



207

85680

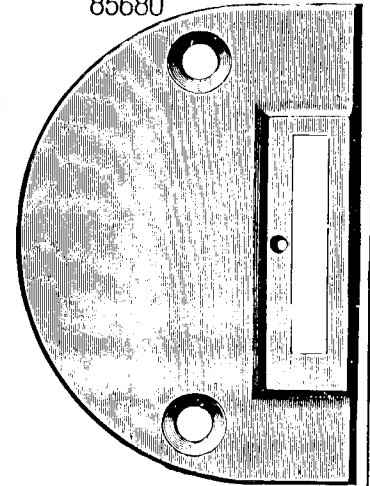

85681

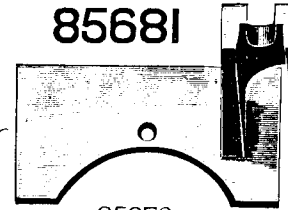

85678

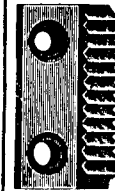

85679

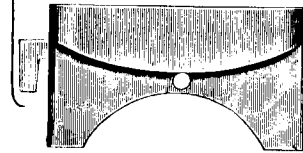

85458

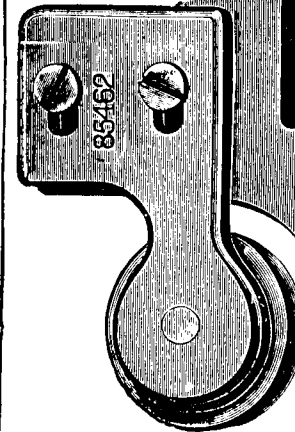

85459



176



85325



85460

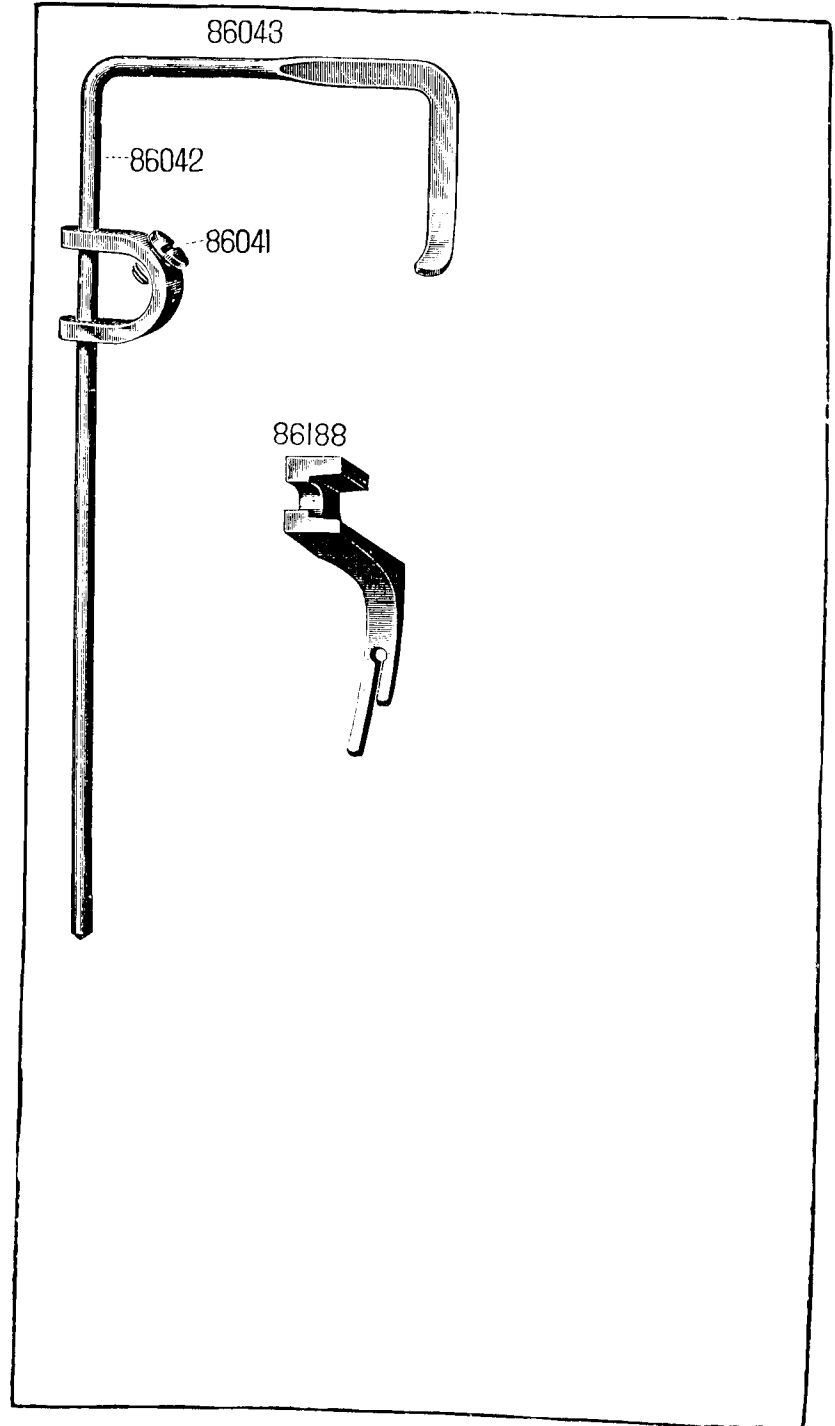
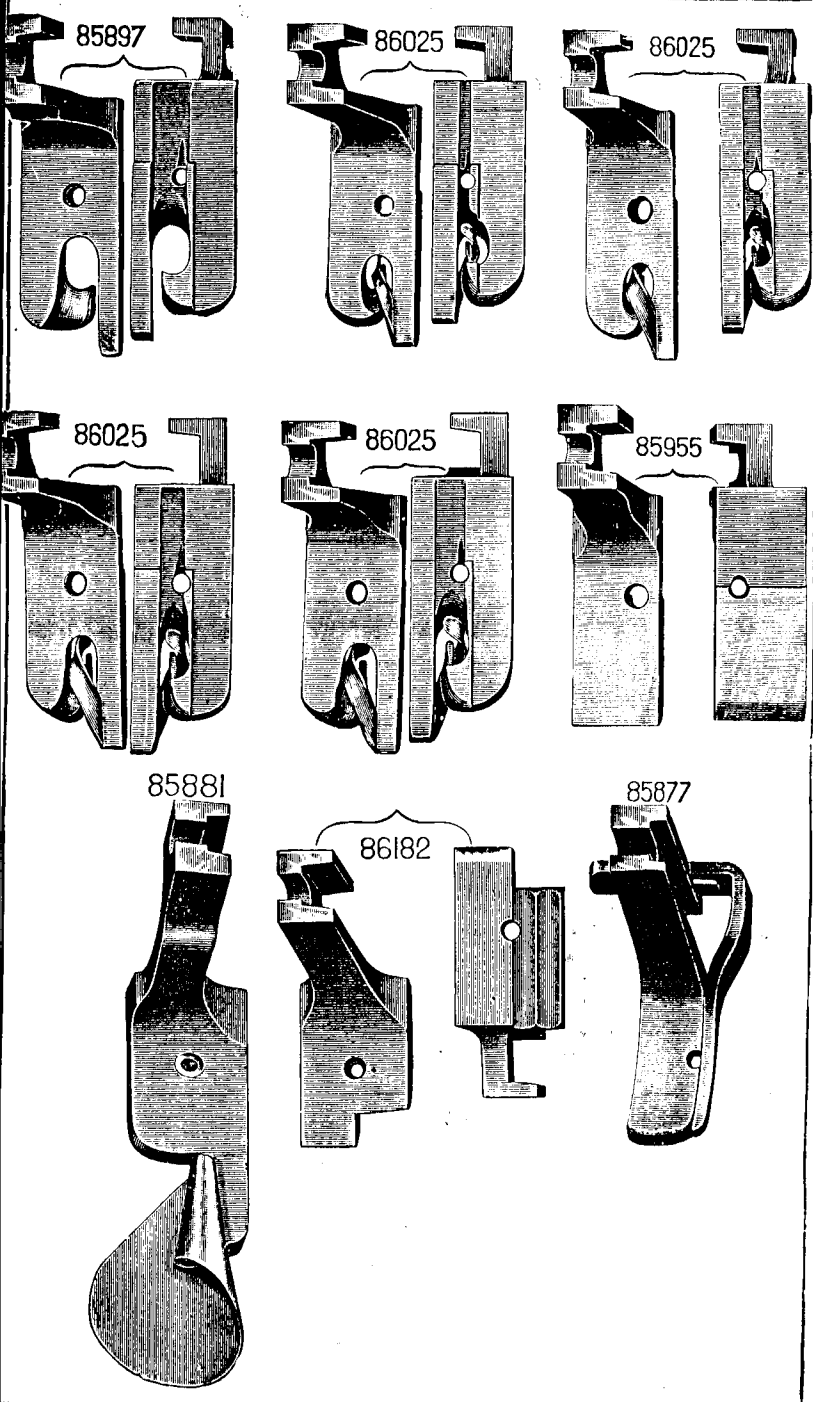



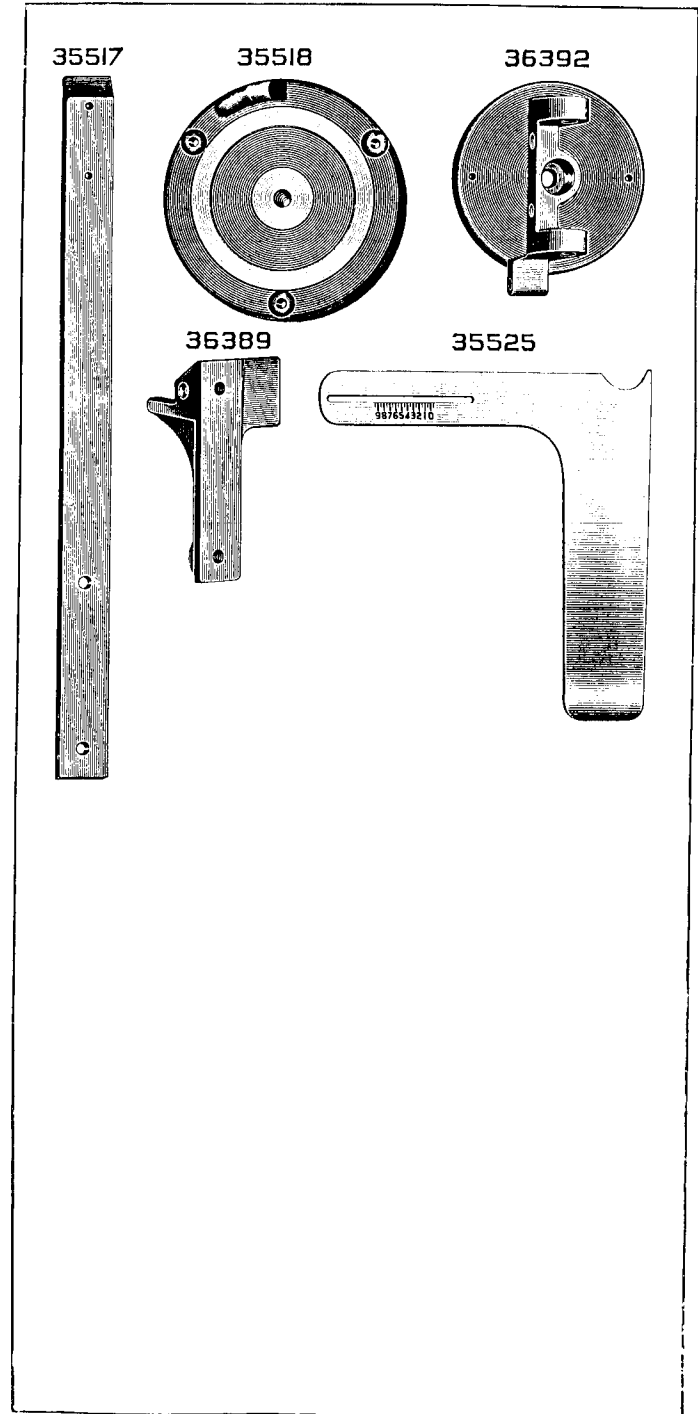
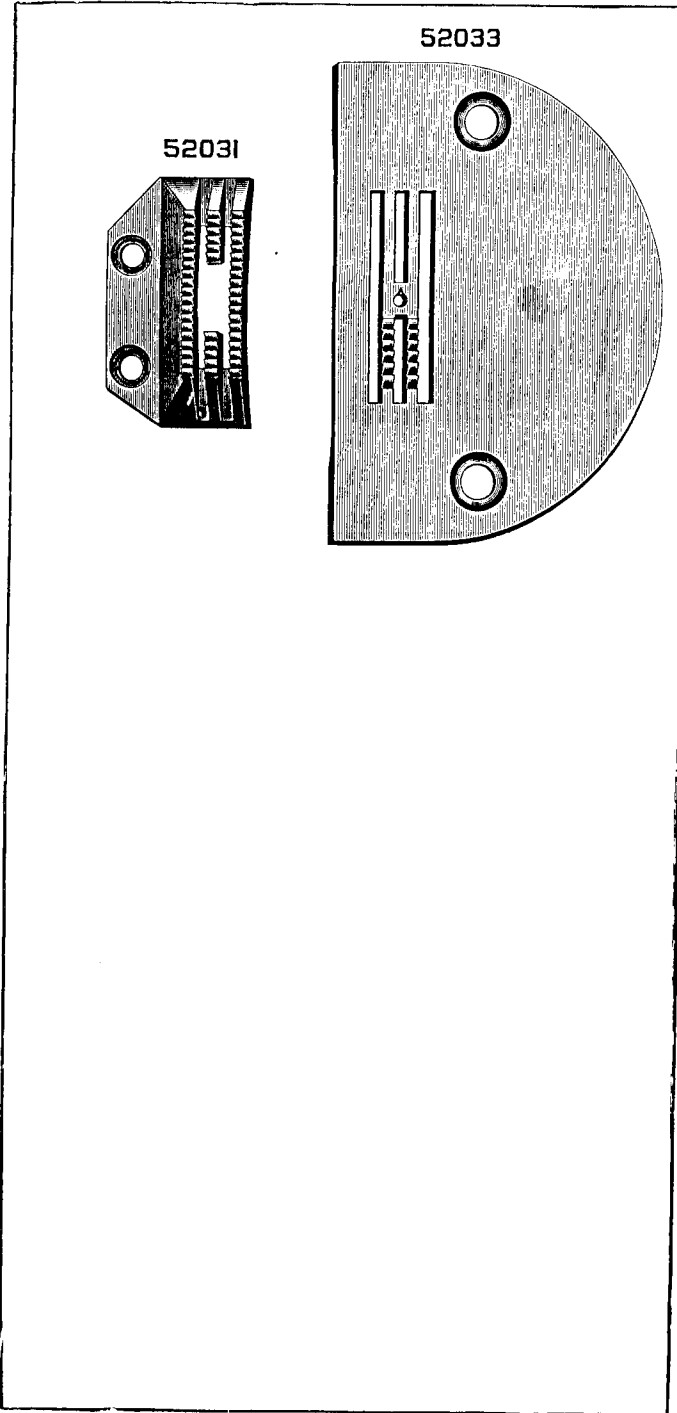

36387

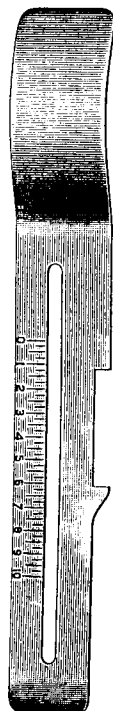

35510

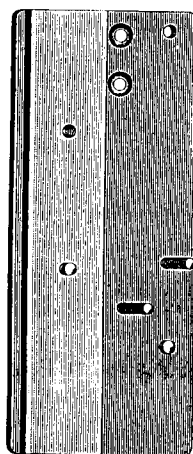

36391

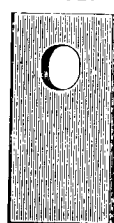

52338

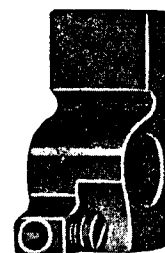

12329



12398



43944

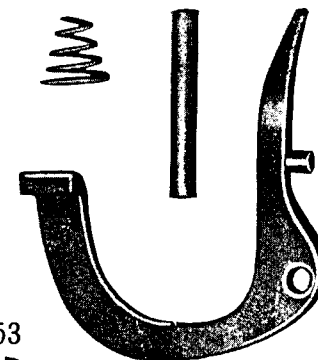

12327

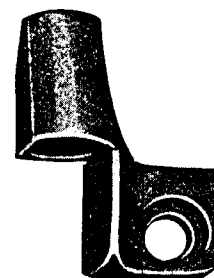

453



41593



41594



41595



223



52337

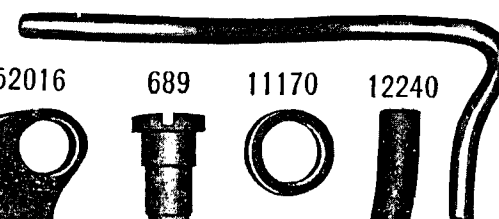

52016



689



11170



12240



1520



12241



12416

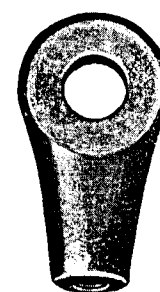

8879

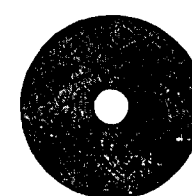

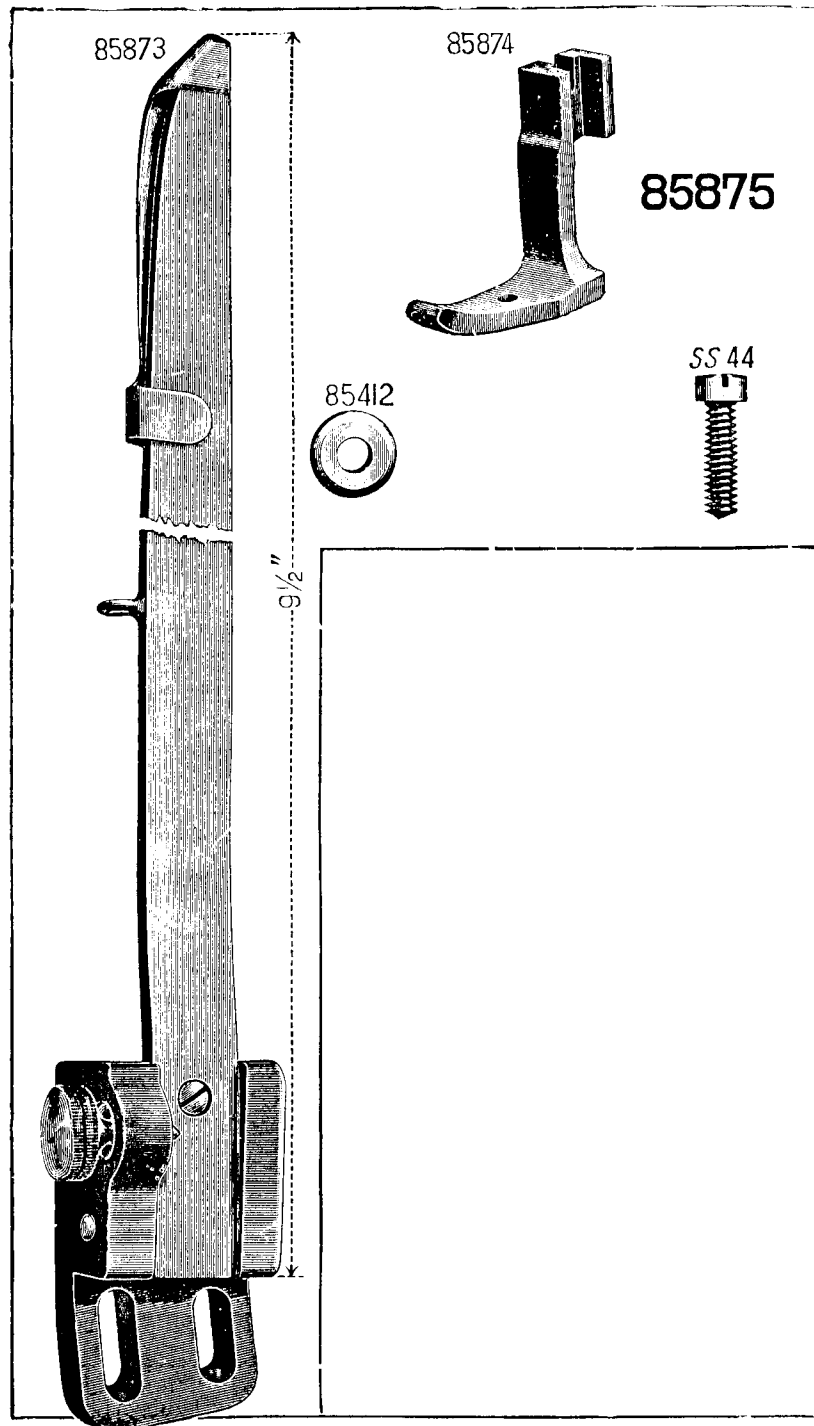
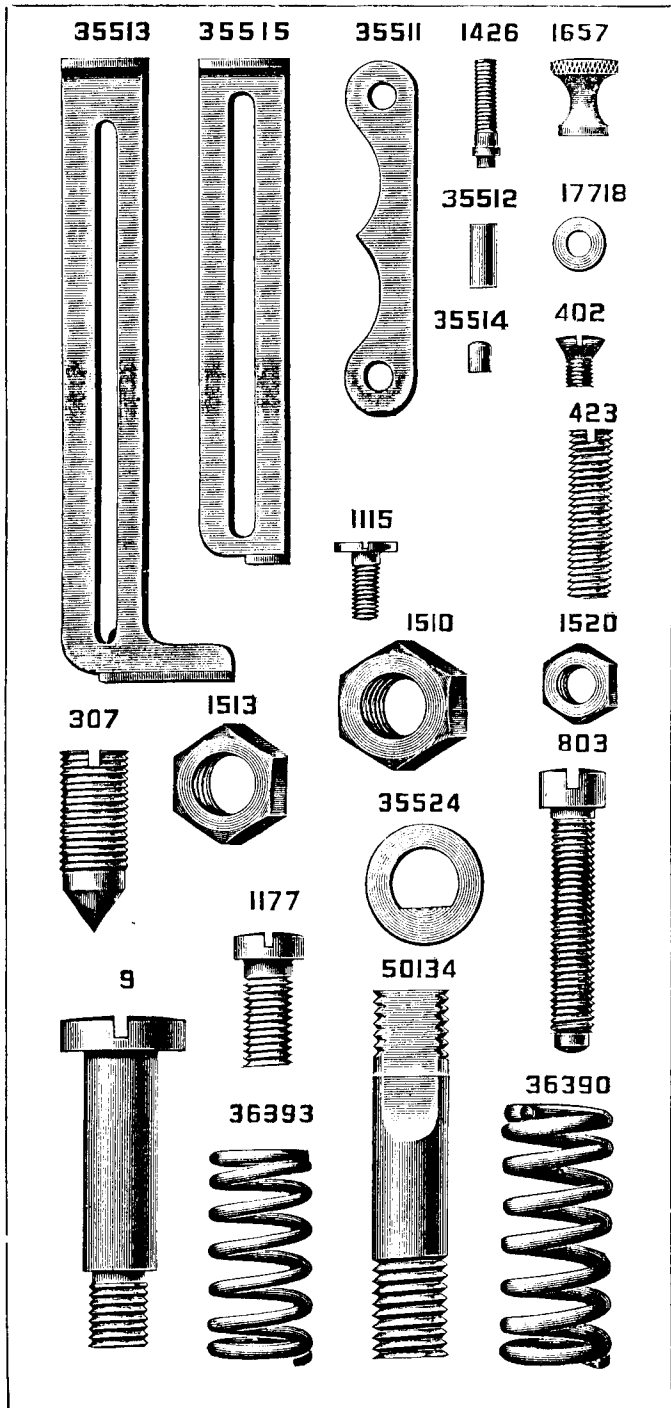

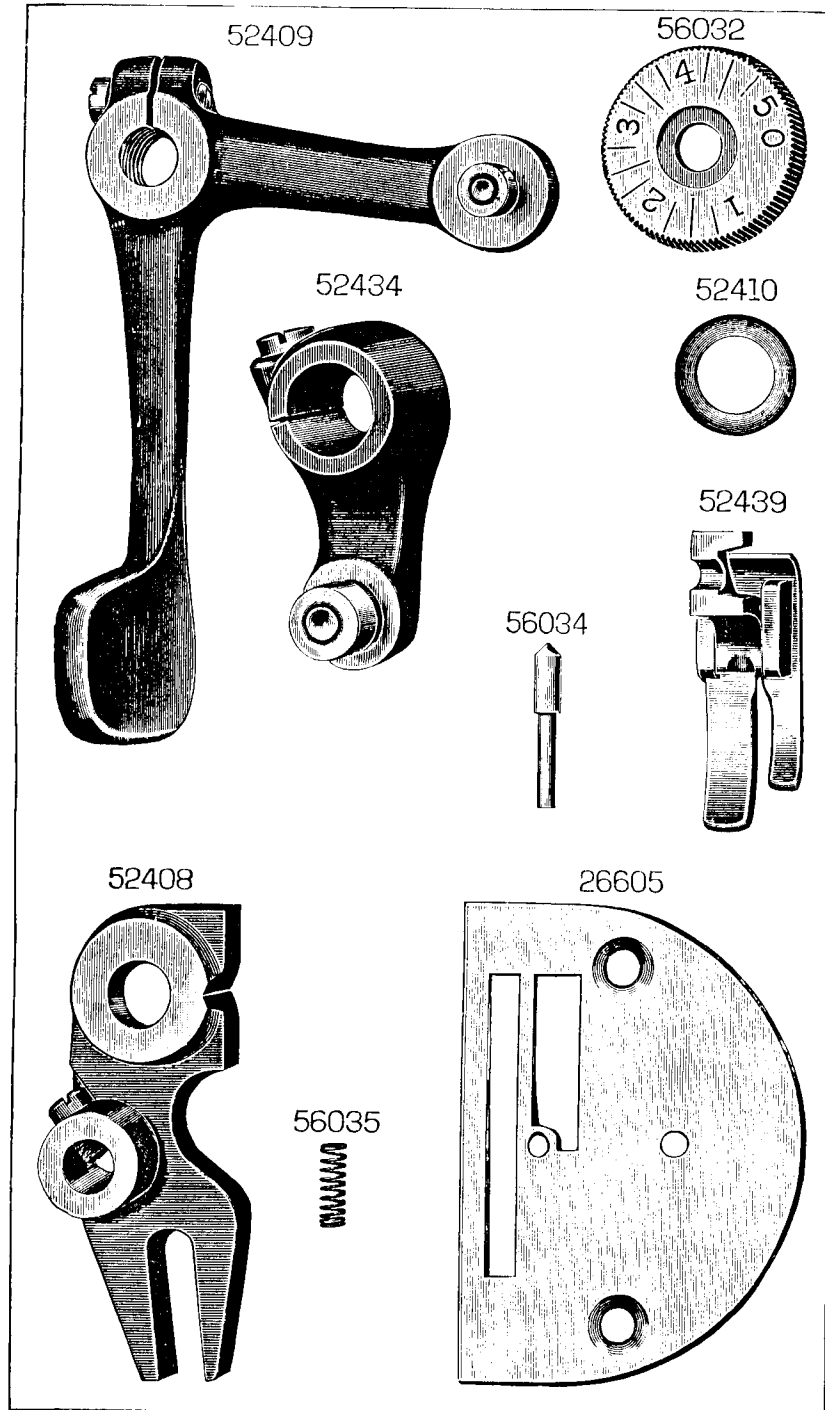
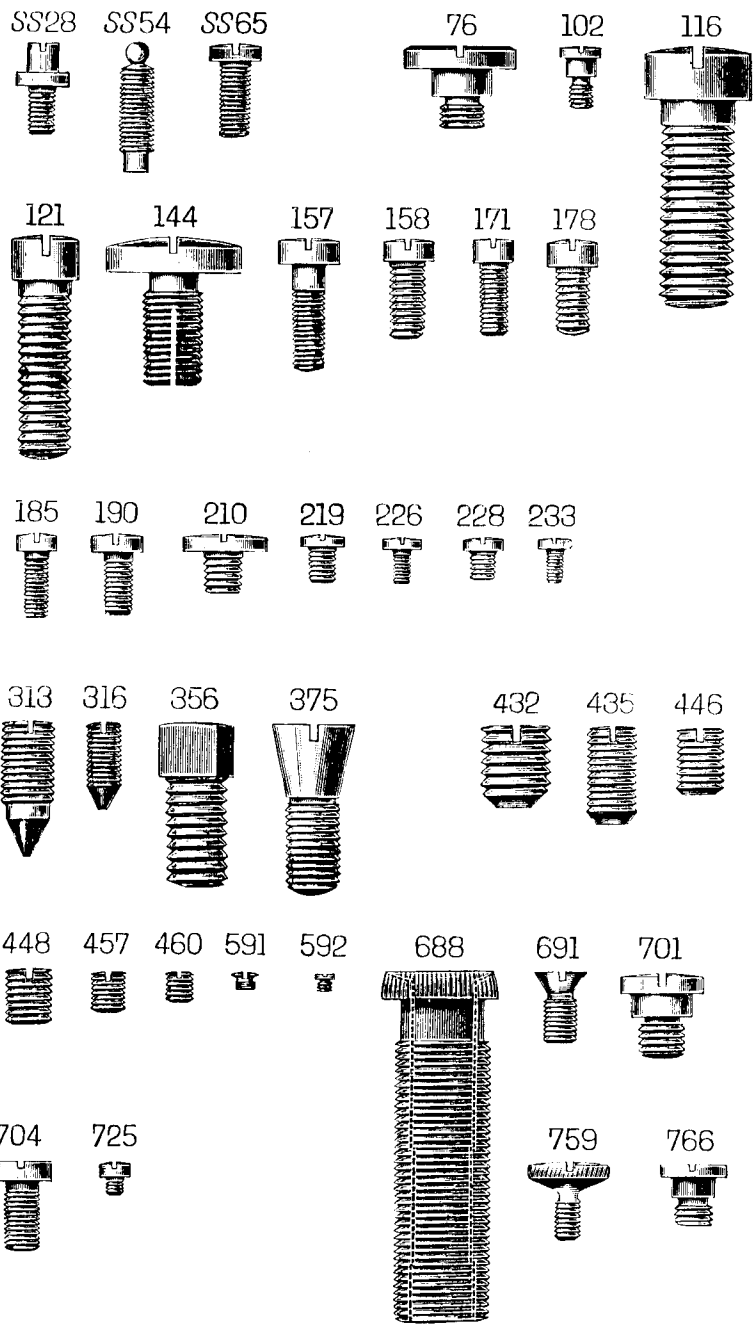

228692 52448

5990

52445

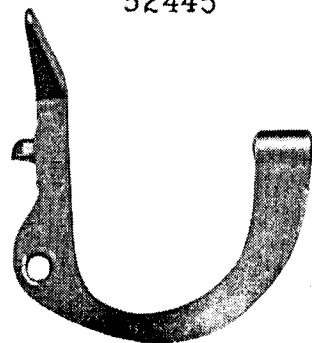
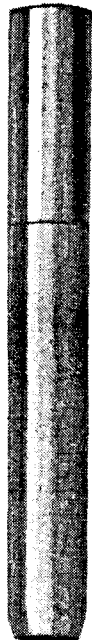

52210



52211



56033



82538



201528



52022



44137

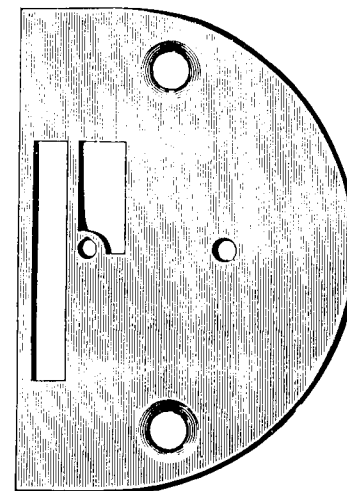

44136

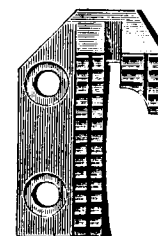

86479

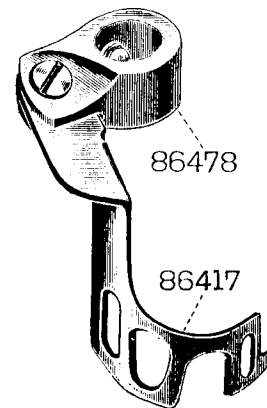

86478

86417

40322



35528

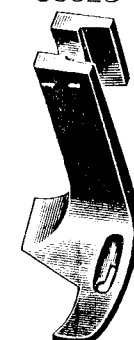

36654



20067

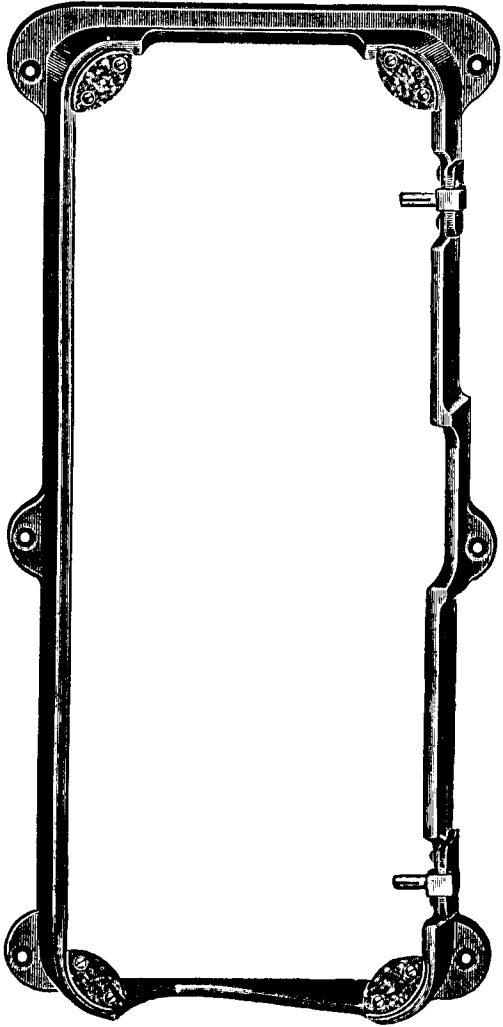

26603

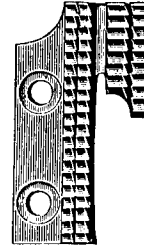

28360

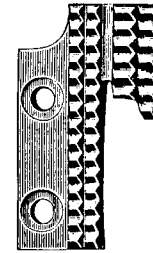

20356

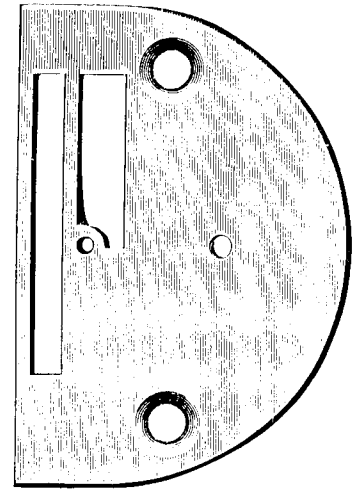

52427

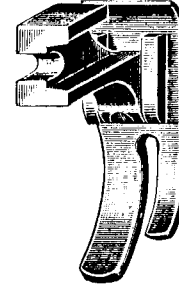

52401

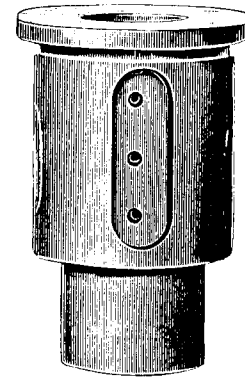

52404

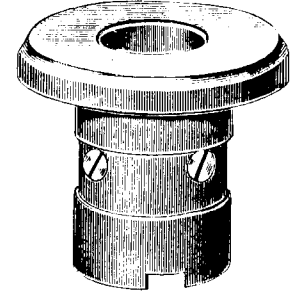

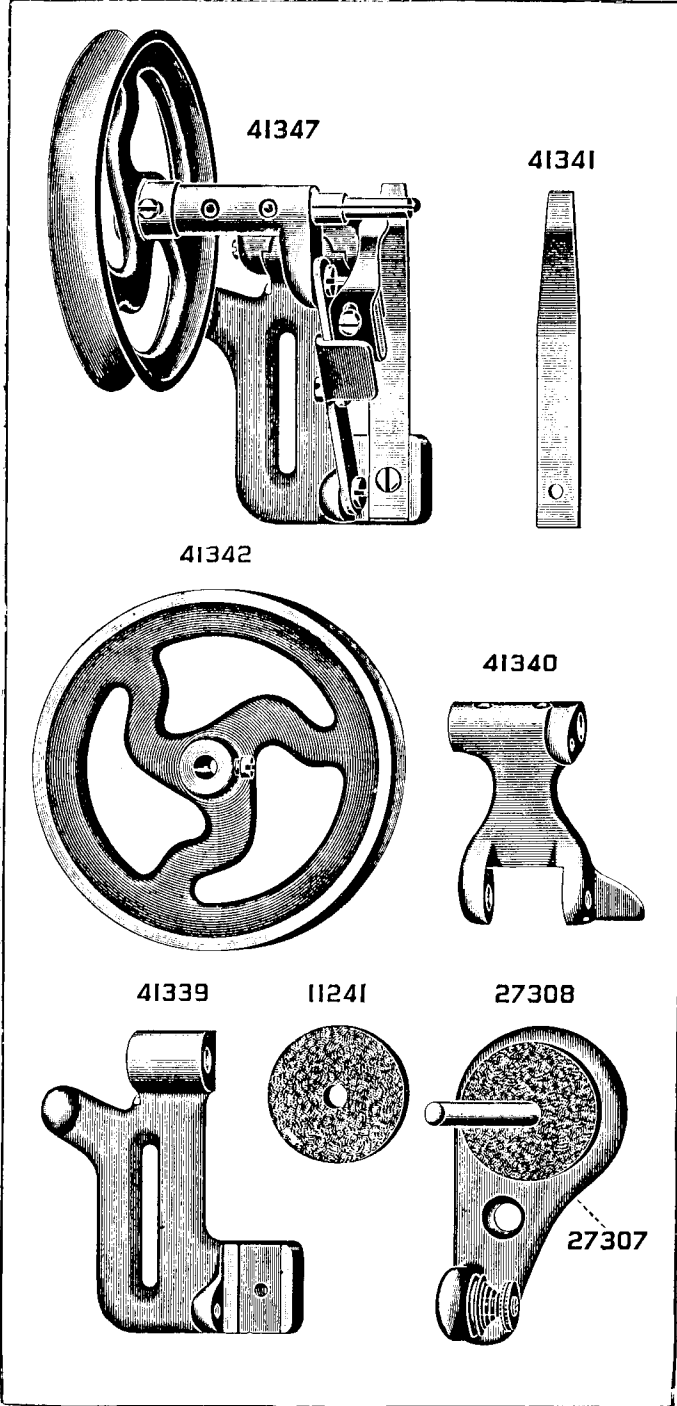
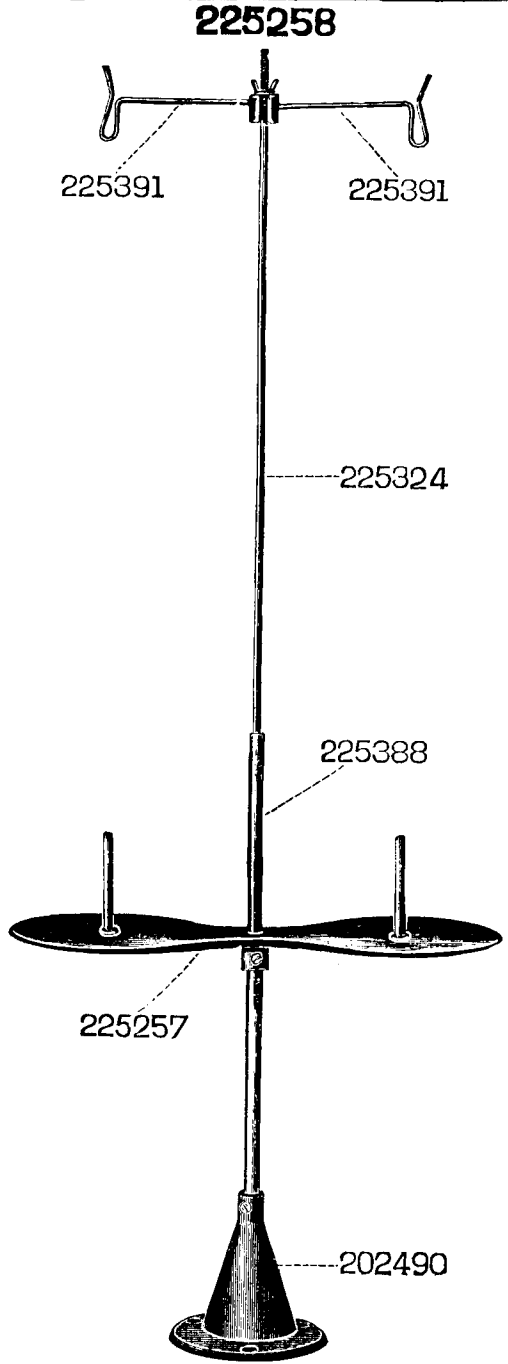

27306



41343



9331



41346



41344

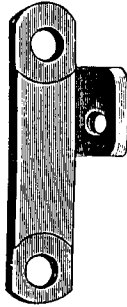

41345

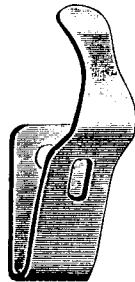

1429



207



1430



152



200



1550



2106



418



2455



10141



1562



127047



97502

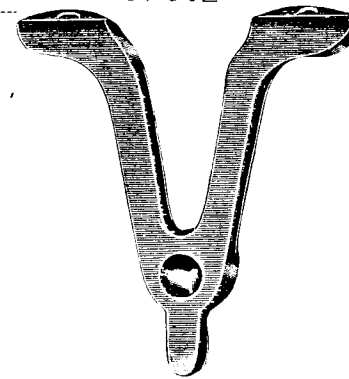

52047

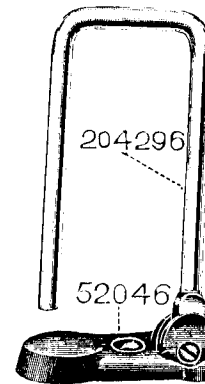

204296

52046



86546

86539

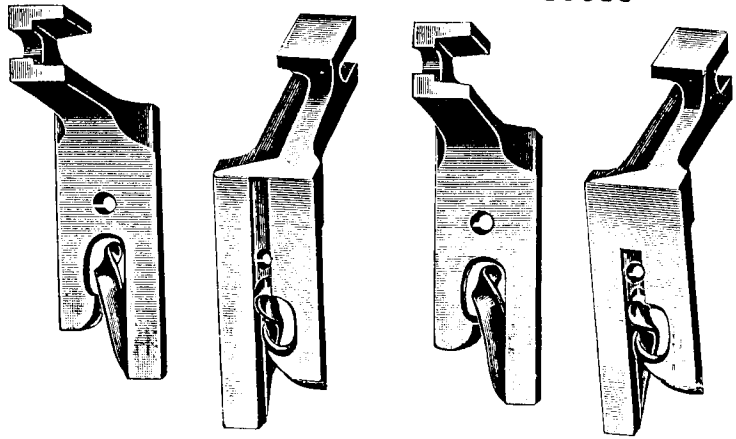

41587

60845

41585

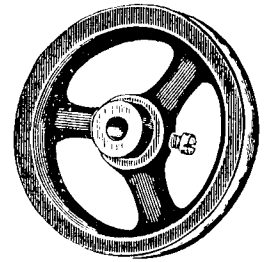
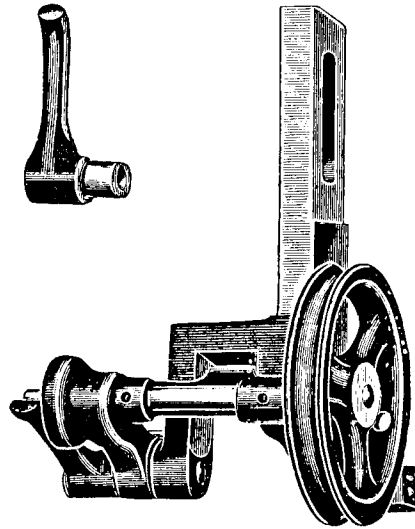

41588



41913

41586

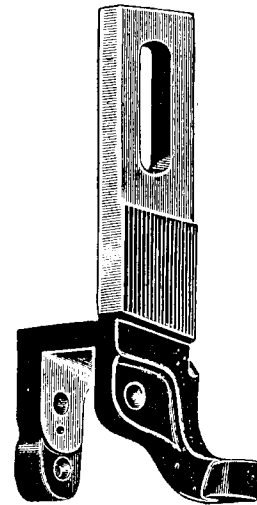

41583

41914

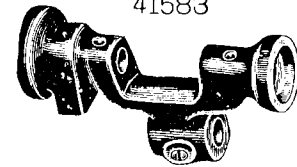

34105



42614



52052

52452

127058

12391

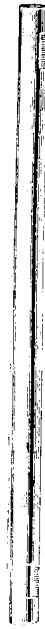
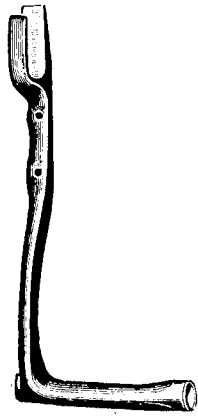
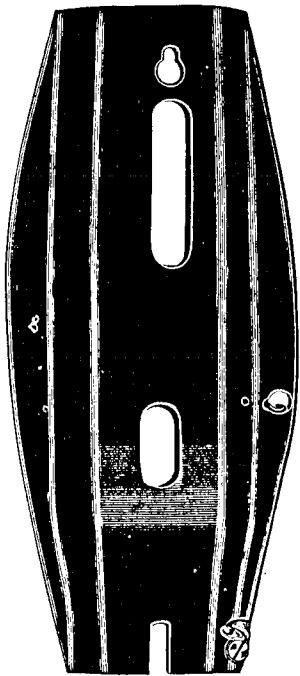

127079

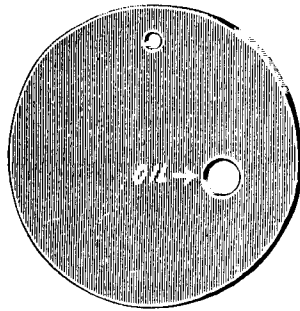

12432

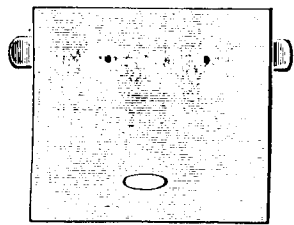

4307

5596

5599

5598

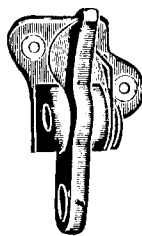
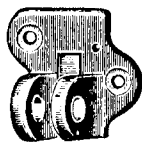
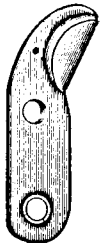

20284

52407

52384

52386

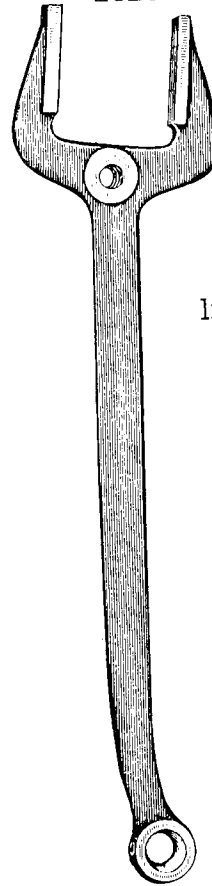

127108

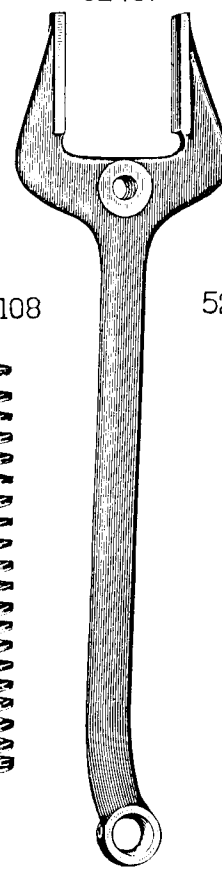
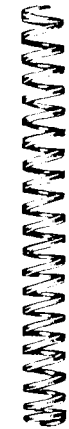

52028



52063

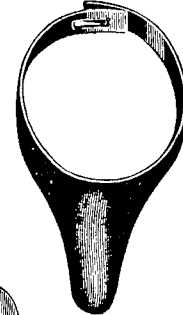

127070

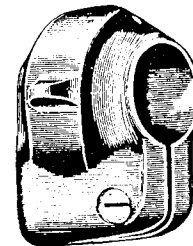

127007

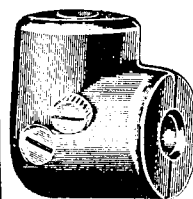

14 3/6"

14"

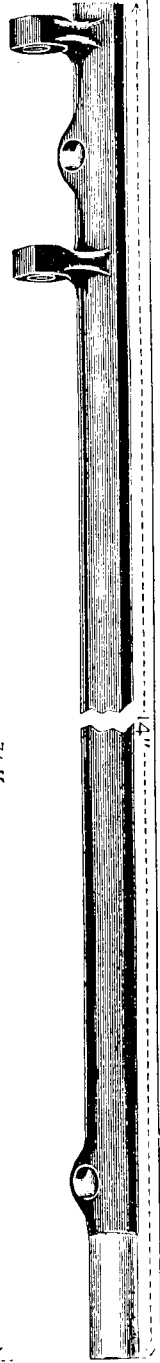
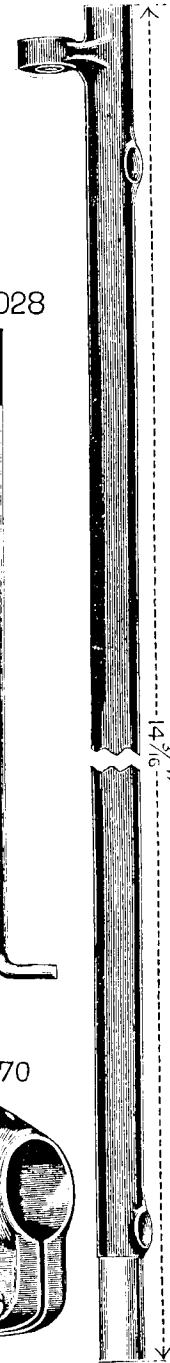

56017

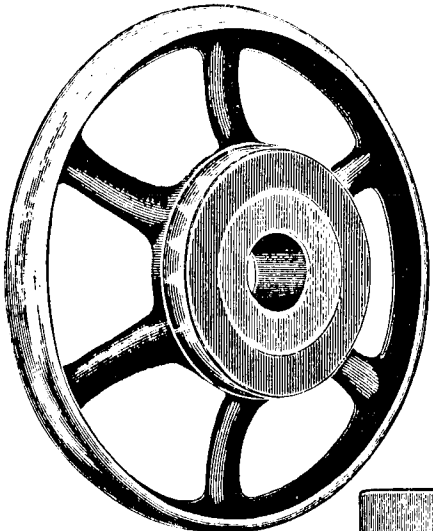

12142



12260



52418

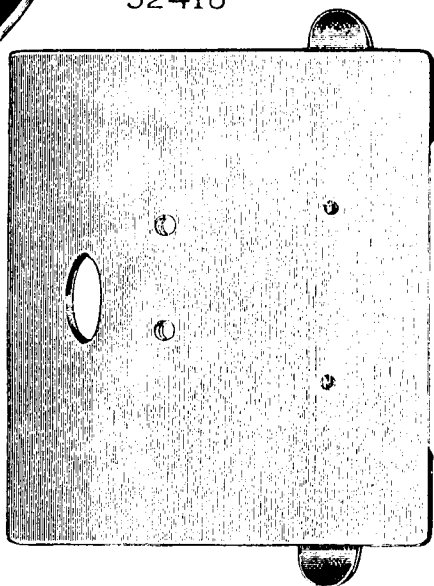

19336

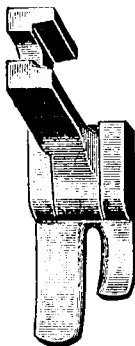

12474

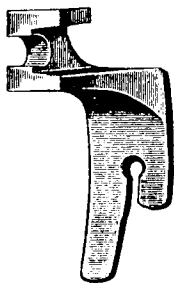

20458



20158

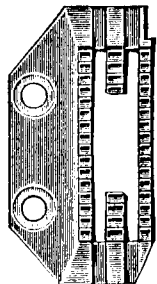

52454

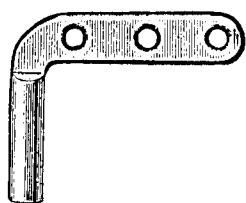

52053



36569

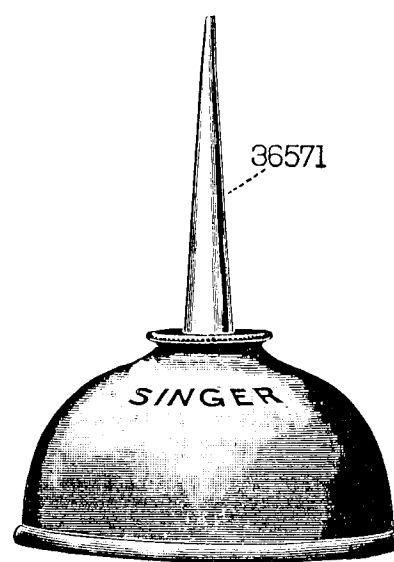

36571

25866

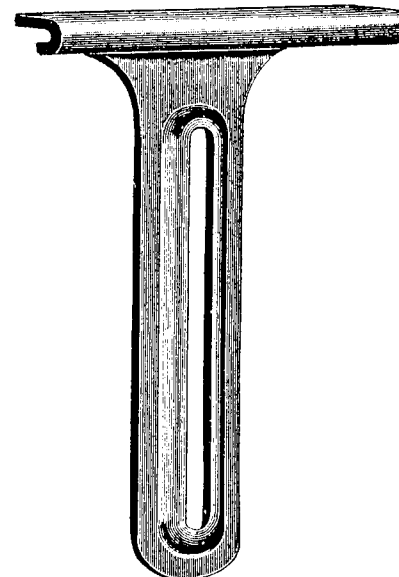

25537

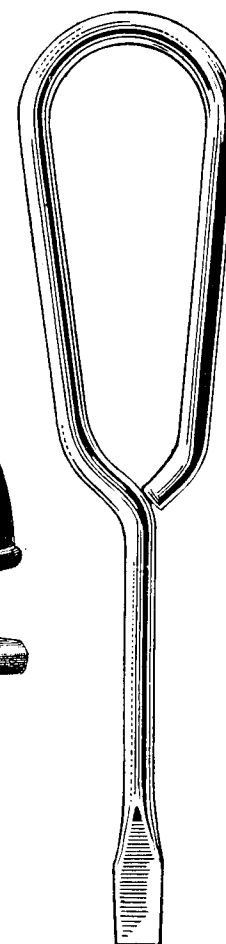

120378



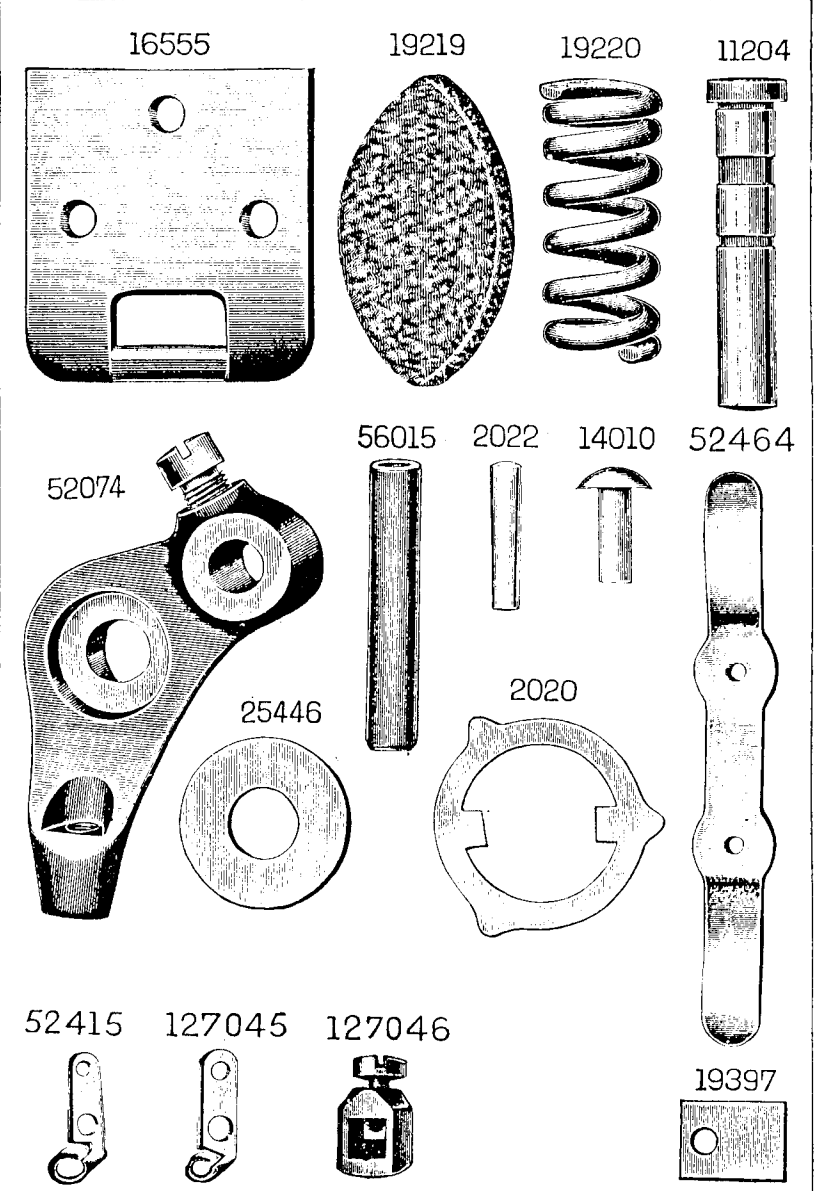
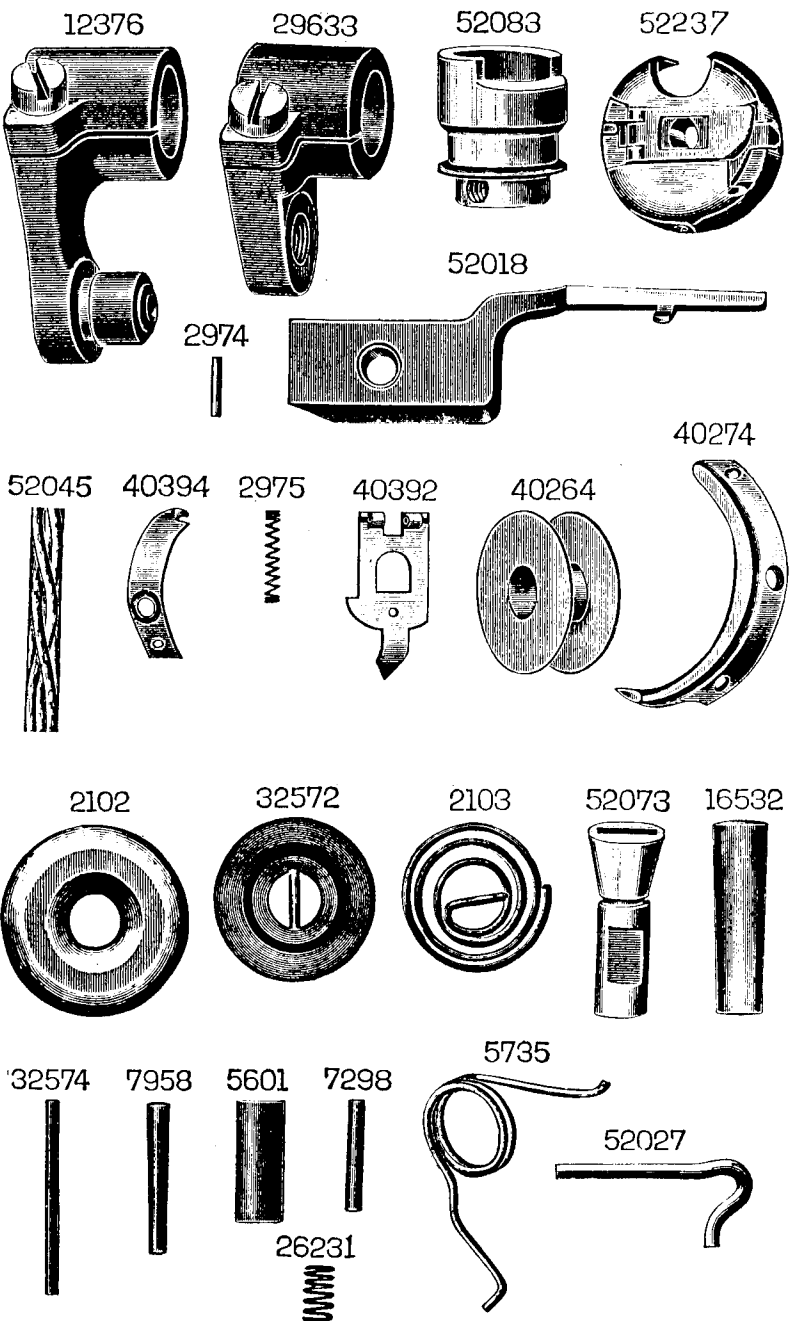

50191 50304 50338 50339 200079 200383

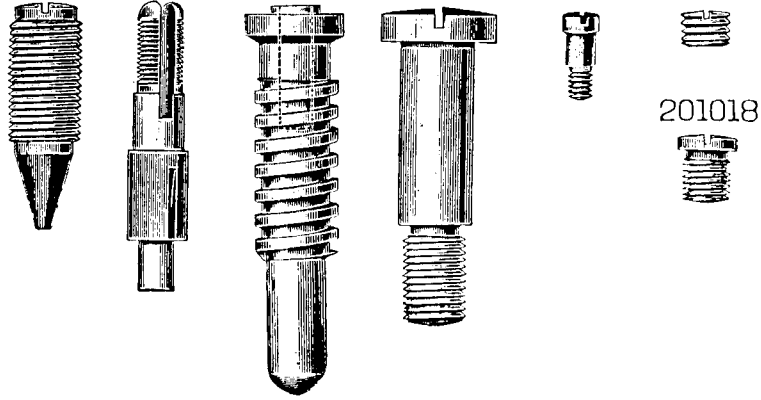

201018



1518 1519 1521 1560 201696

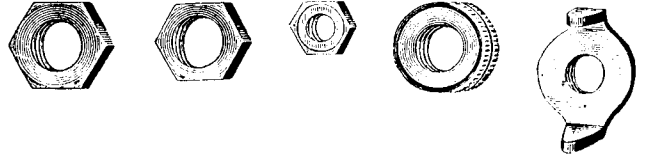

1813 51846

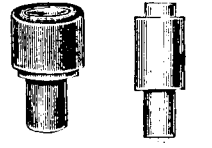

208 211 229 248 256 291 389



624 665 775

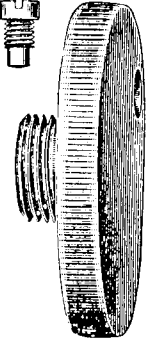

802

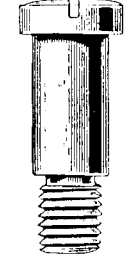

818

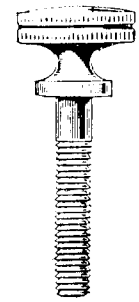

854

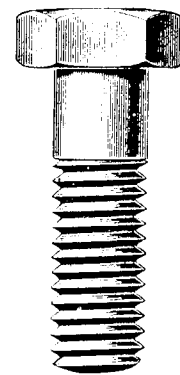

879

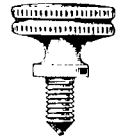

880



966



1036



1037



1053 1065 1128 1133 1143 1148 1253



50053 50083 50117 50190

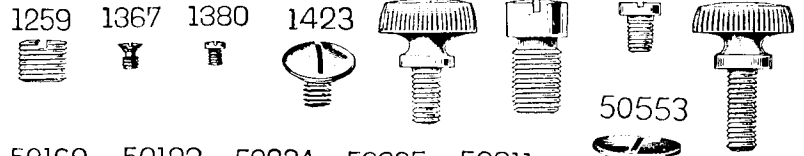

50169 50193 50234 50305 50311



19409

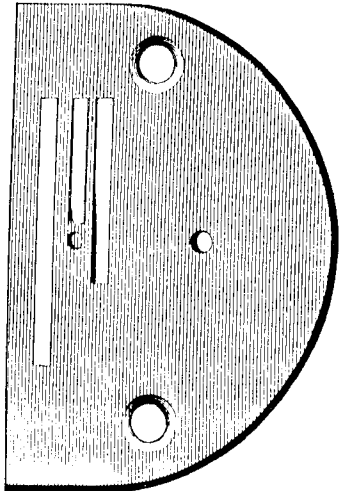

12411

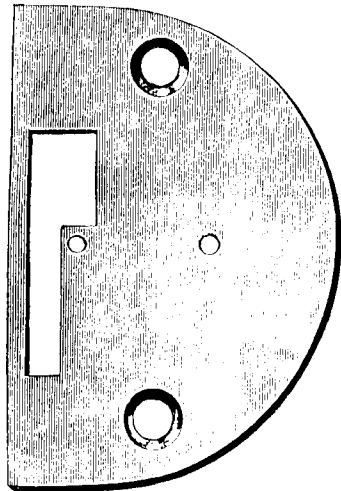

19410

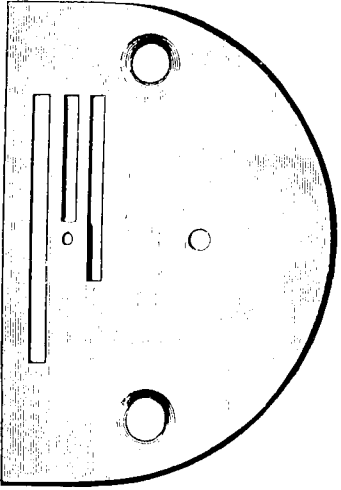

12483

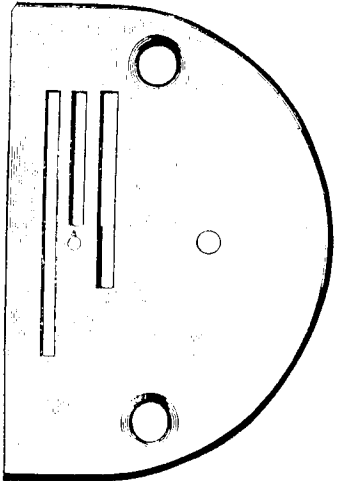

12457

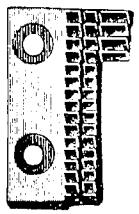

12481

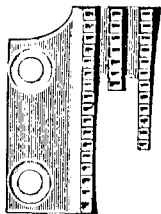

12450

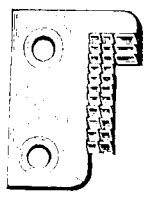

20162

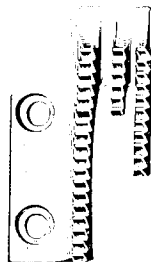

52493



127004



127005



52492



127072

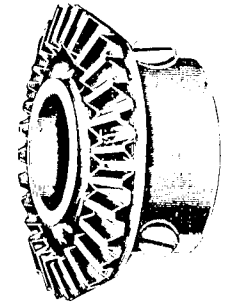

127073

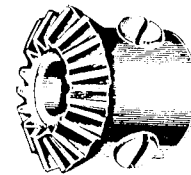

127074

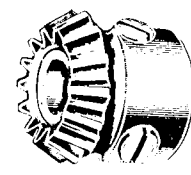

68350



127095

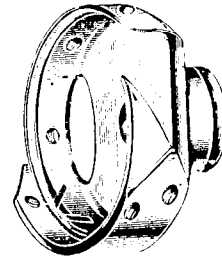

127102

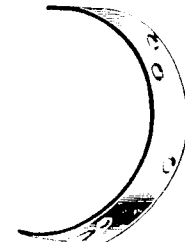

52150



52014

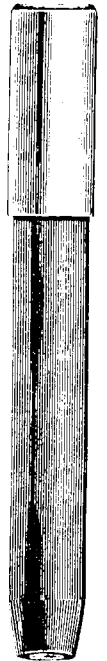

52023



52307



52394

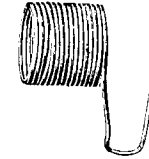

12361



19226



52024

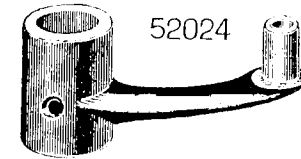

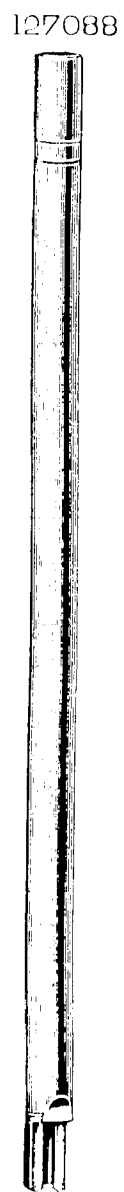
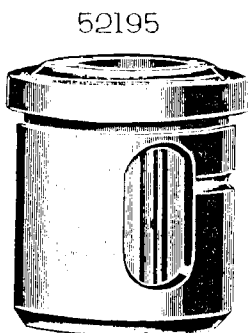
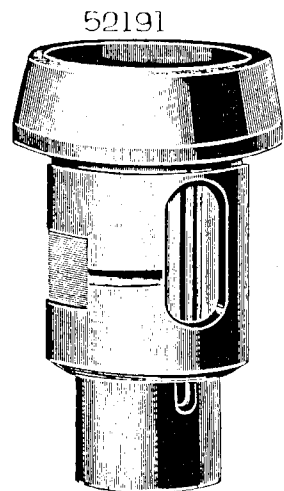

1299



127091

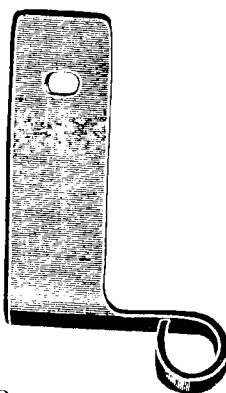

52193

52203

127187

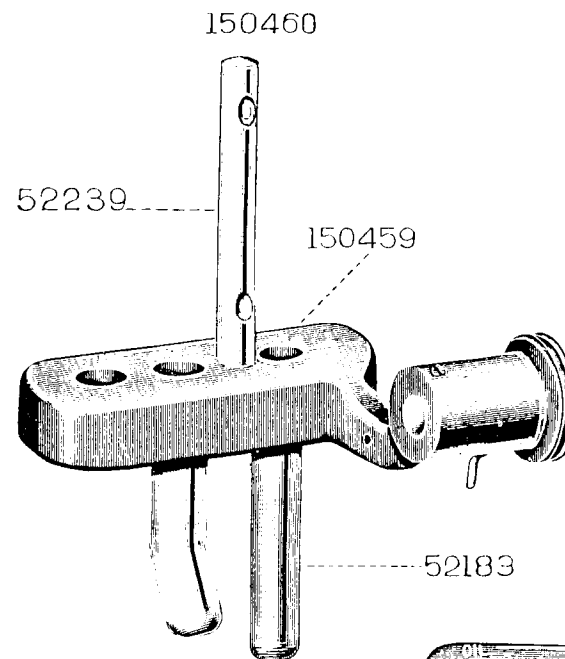
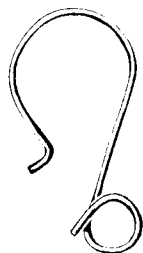

127193

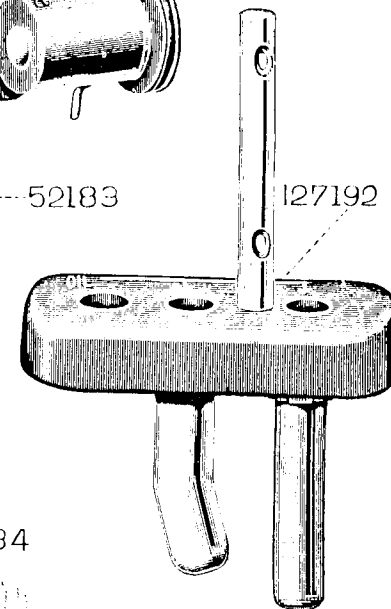

52202

52201



52184



52194



42367

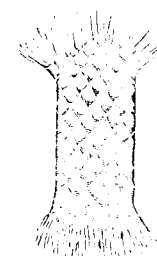

127059

127156

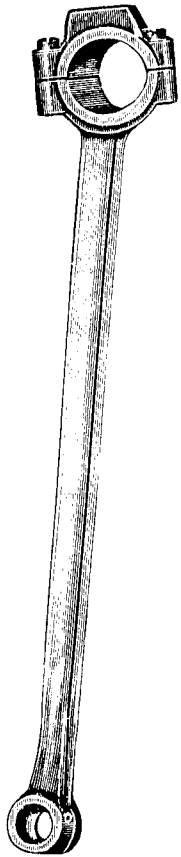

52187

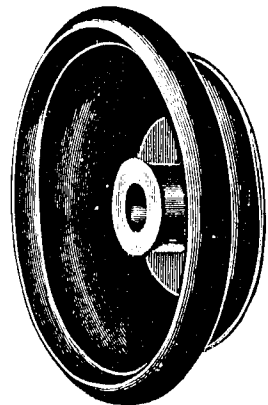

127146

127152

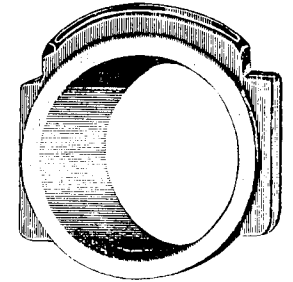
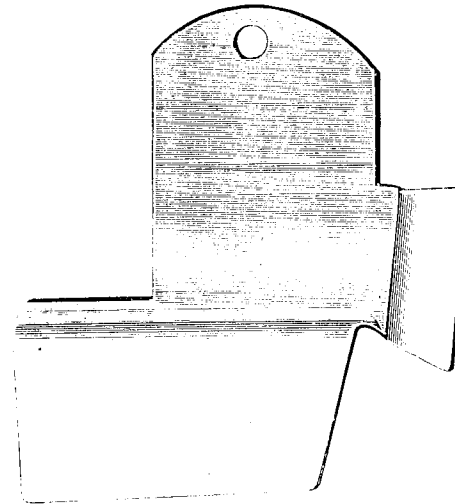

52205

52165

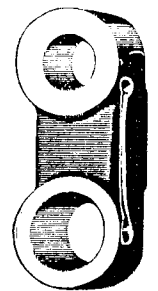
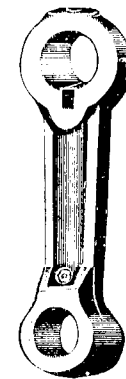

52185

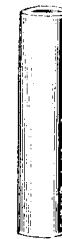

52180

52182

24041

125320

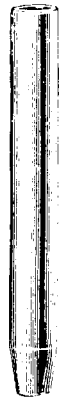



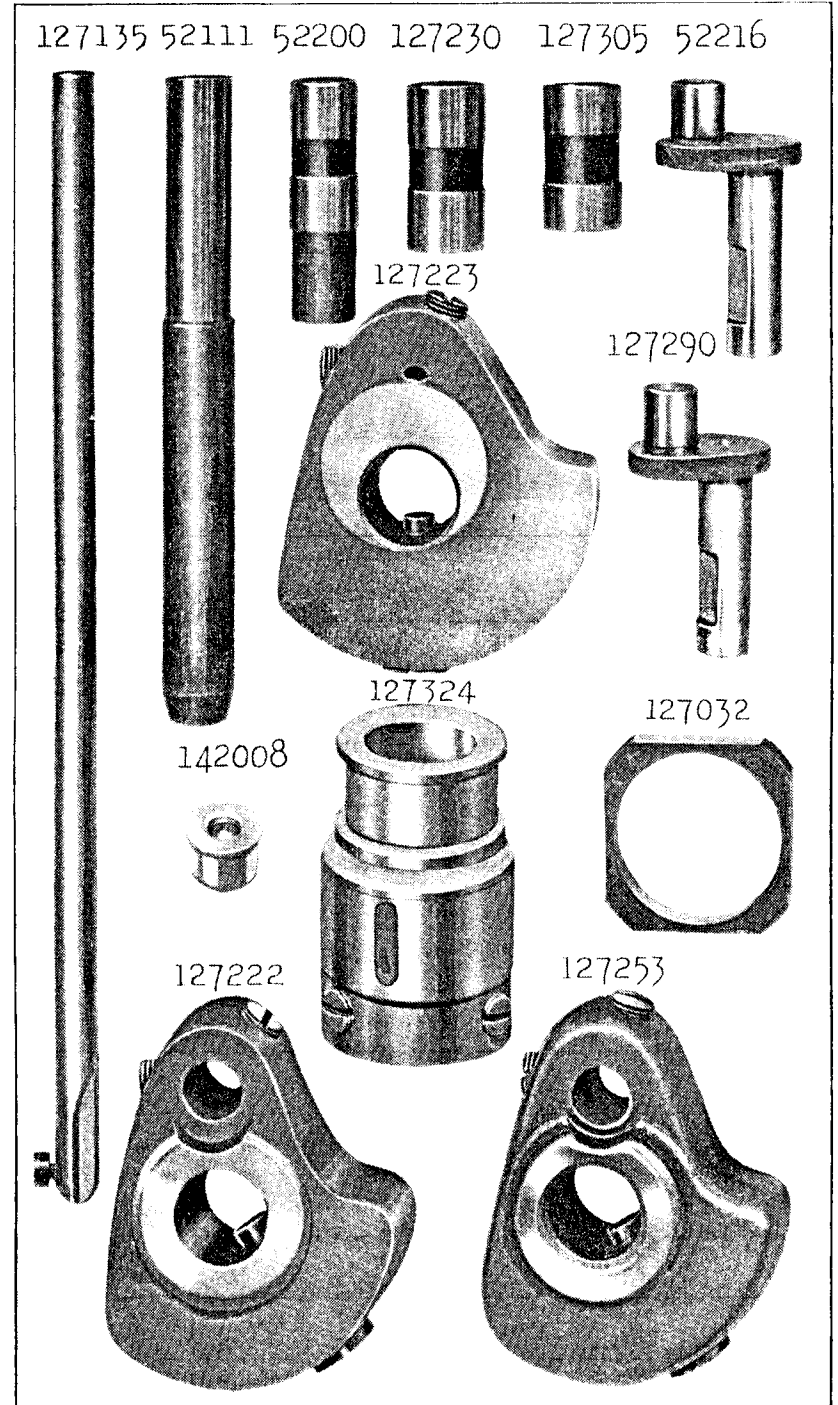
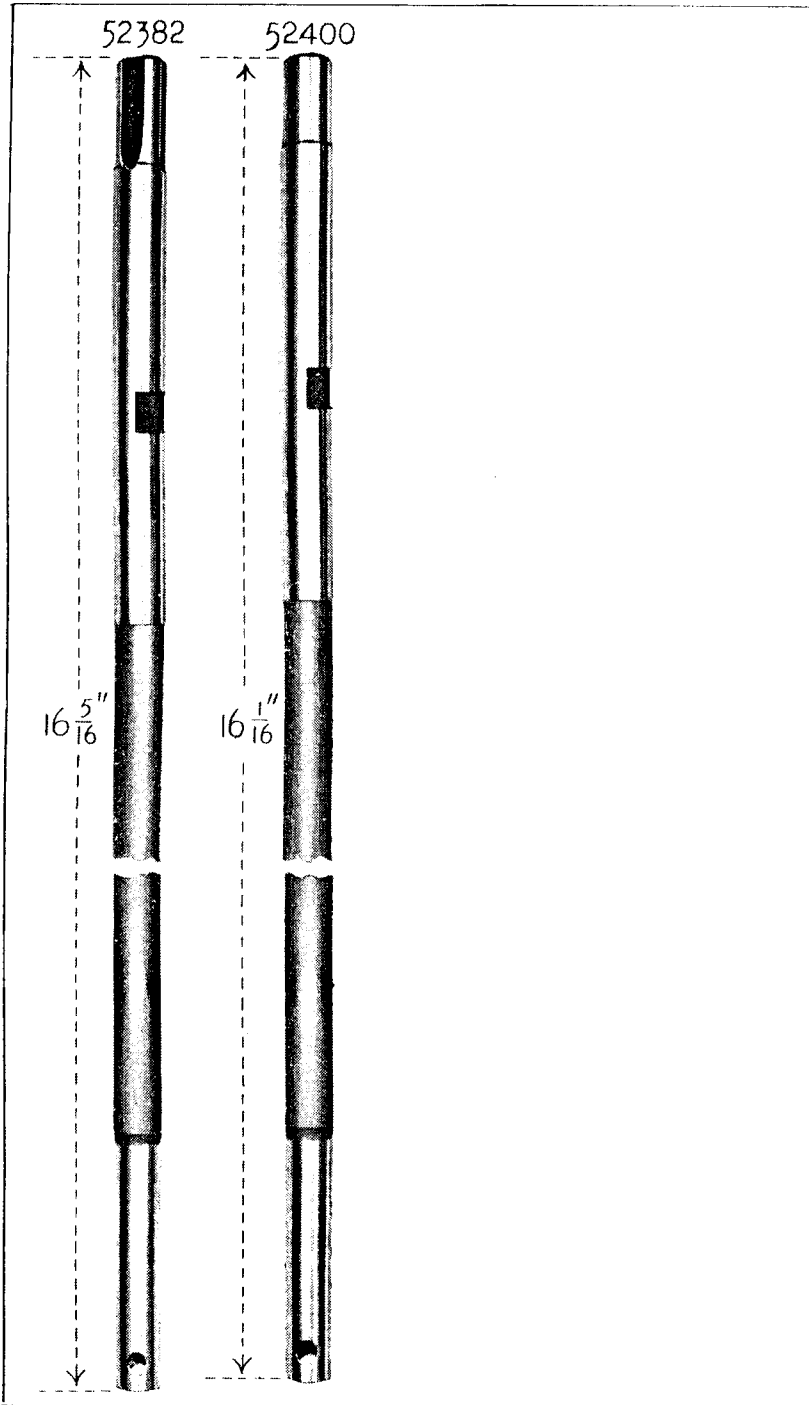

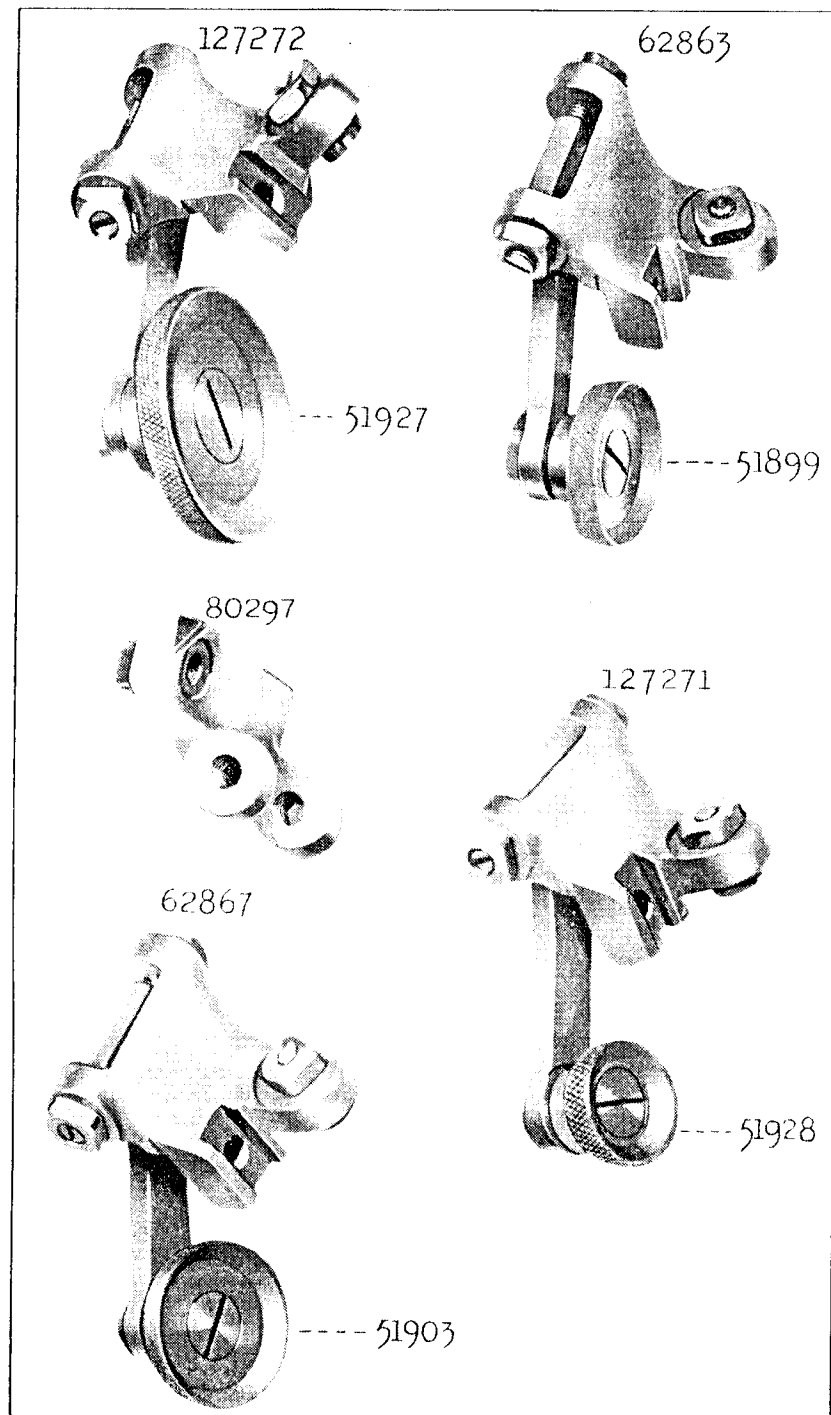
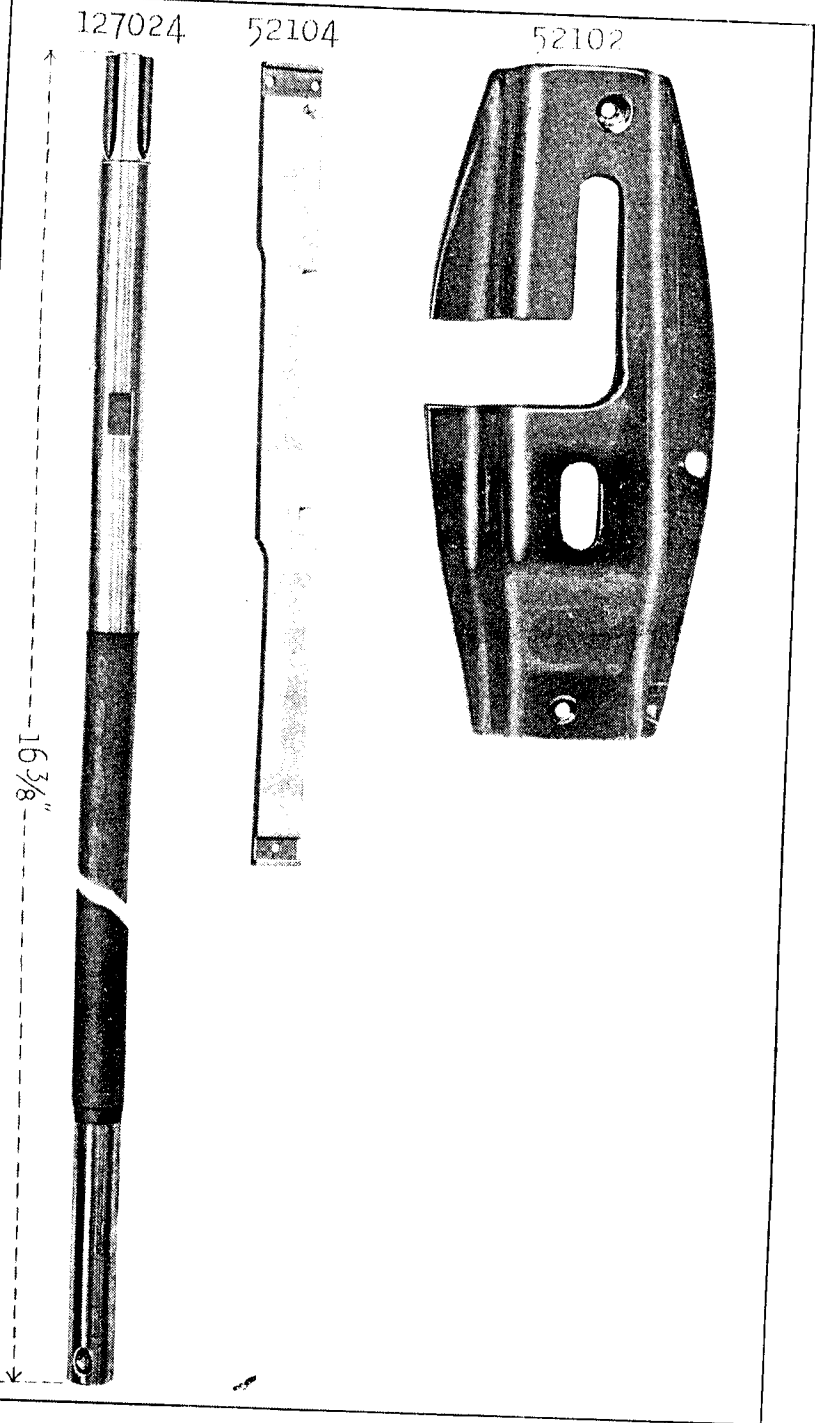

142032



52131



127040

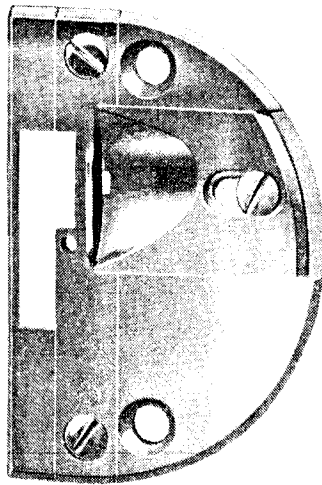

127034



127033

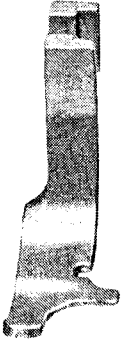

127036

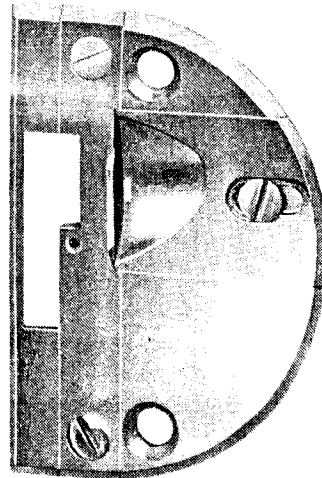

121446

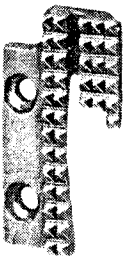

127025

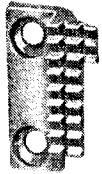

127035

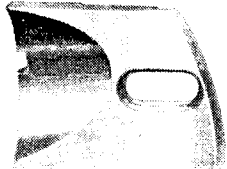

578



127028

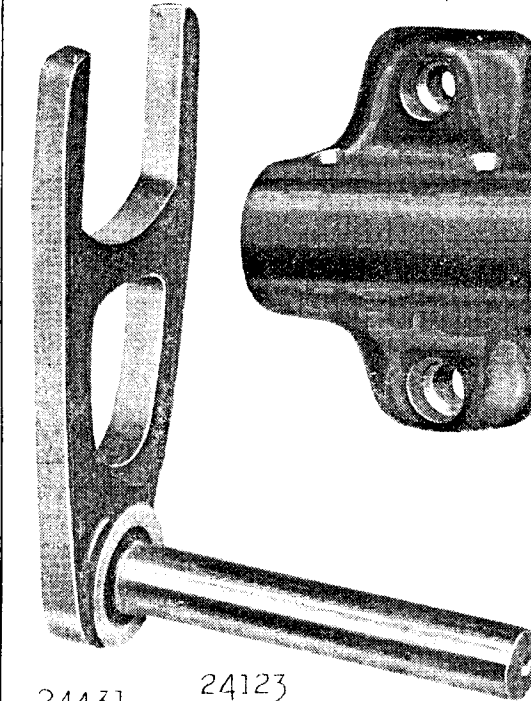

16564

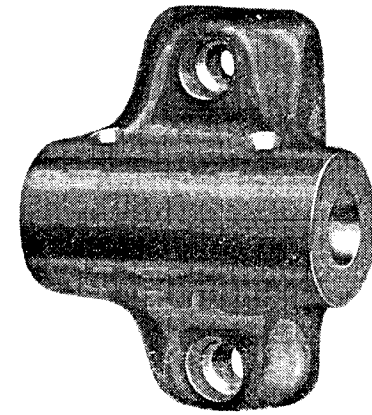

24122



24431

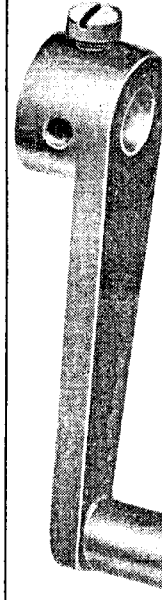

24123

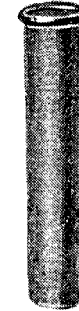

52108

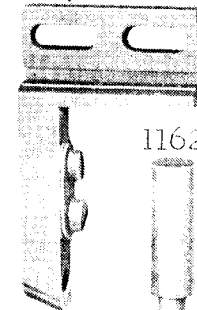

24109 127026

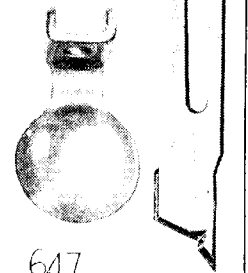

647

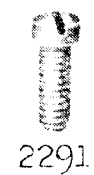

127027

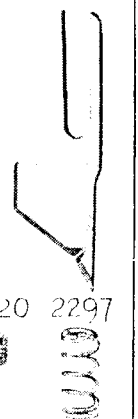

1162



2291



24906



1564 2301 2523 621 620 2297

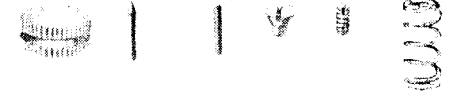

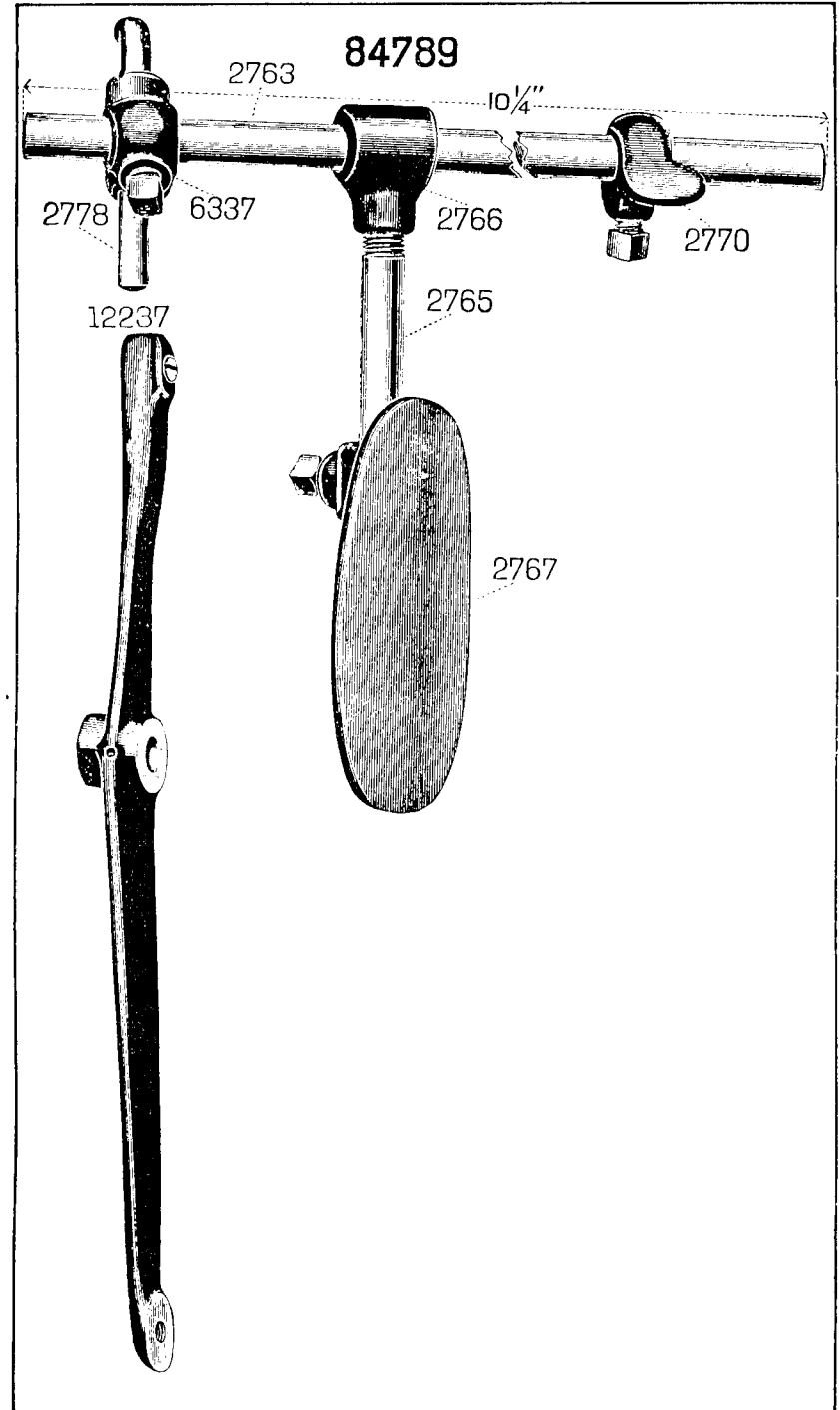
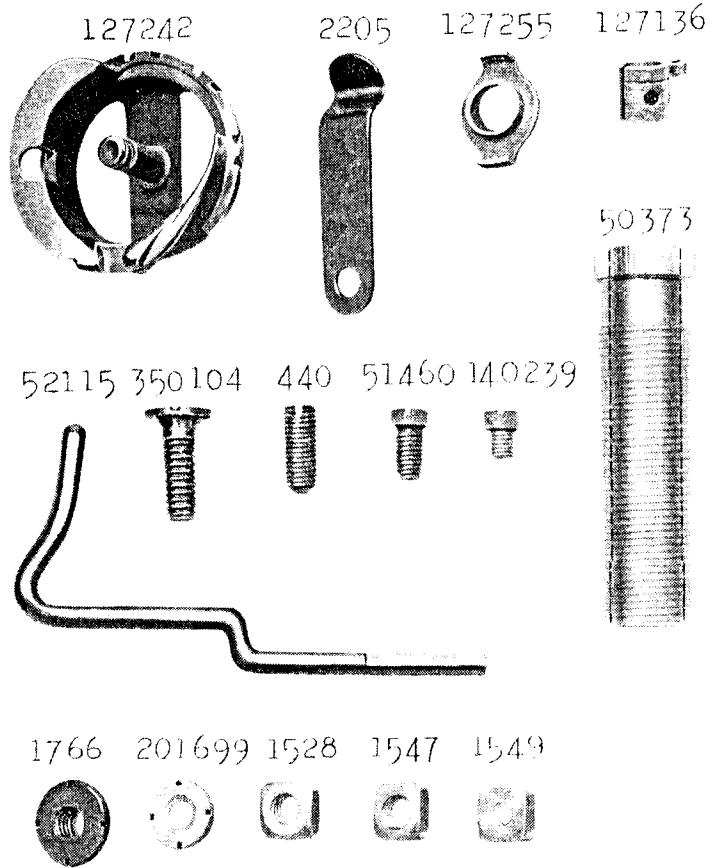

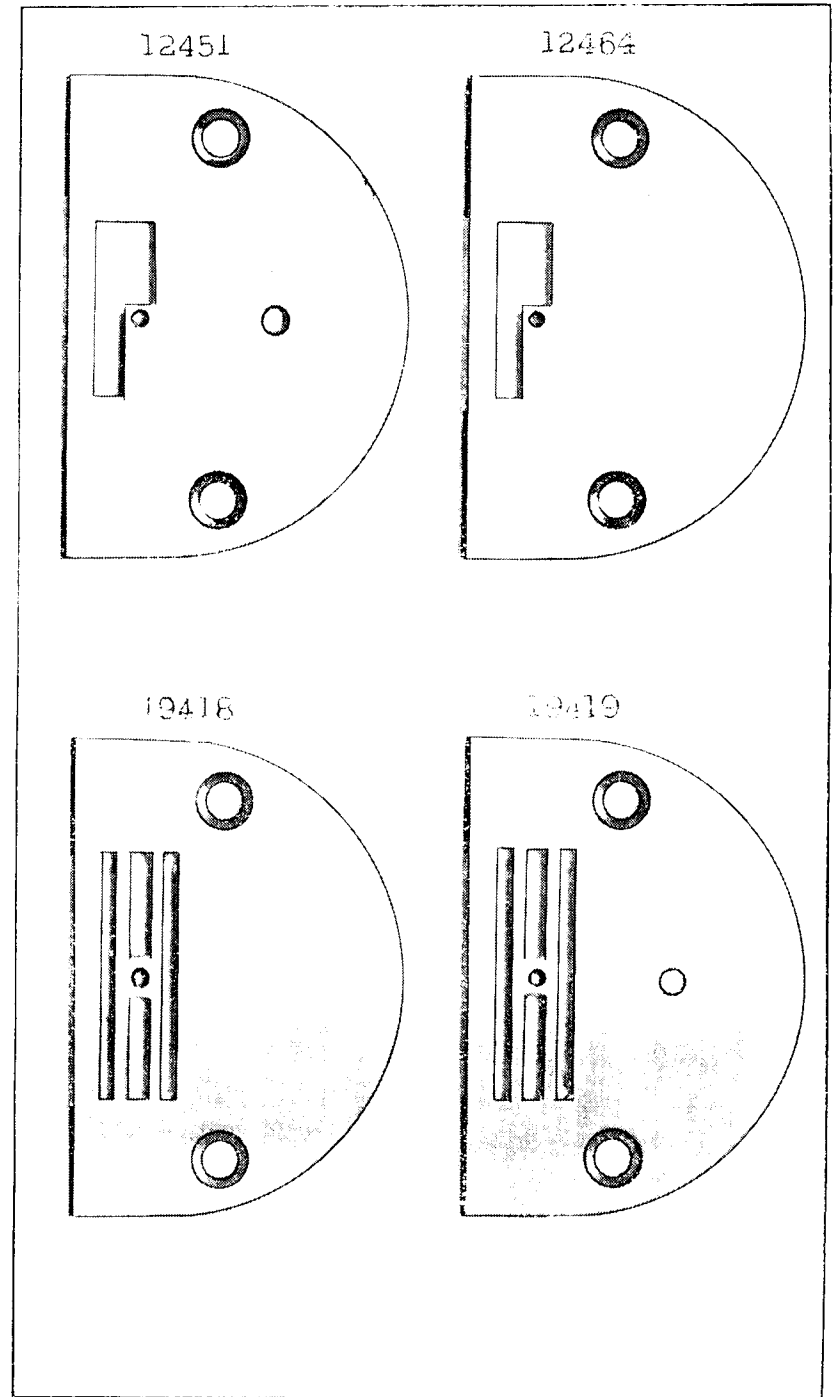
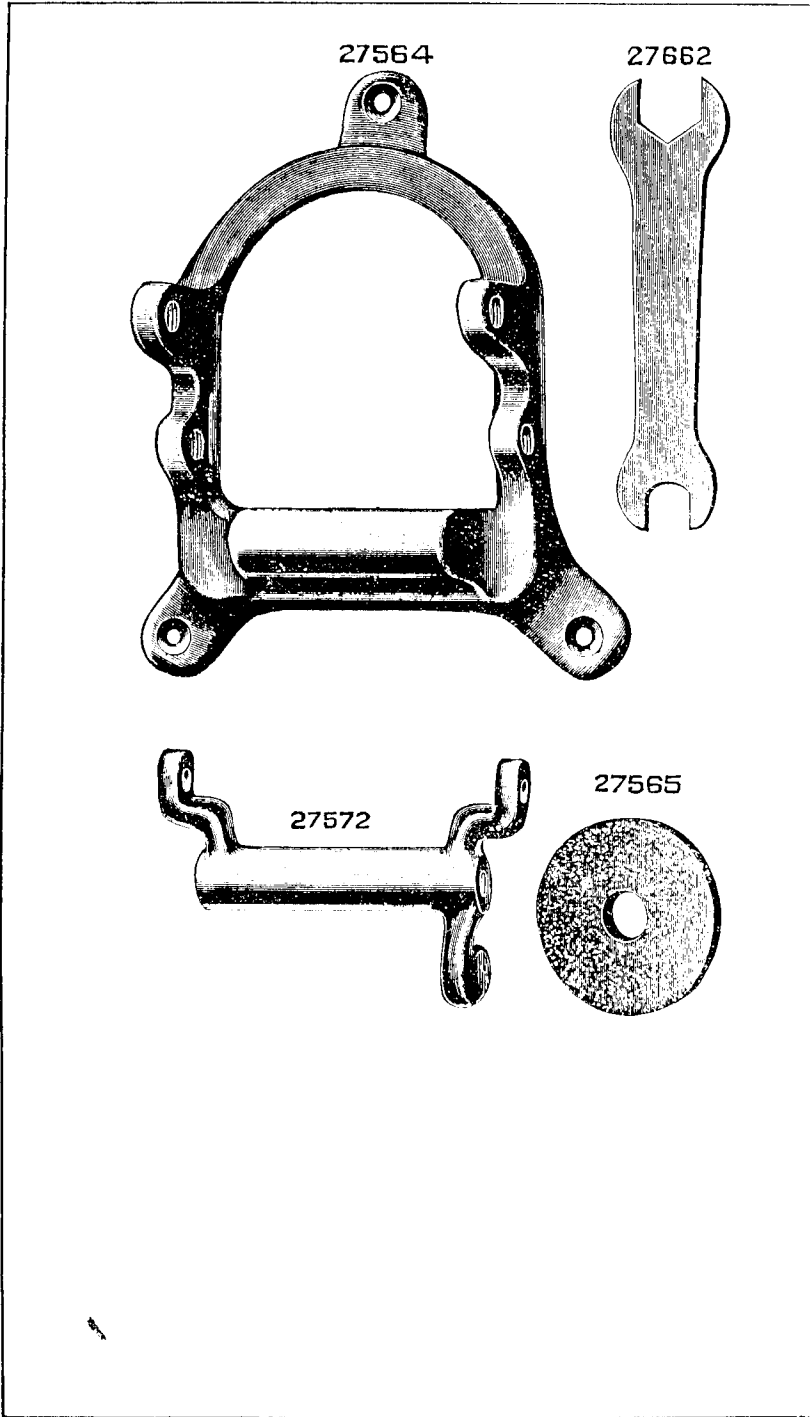

88621



106058

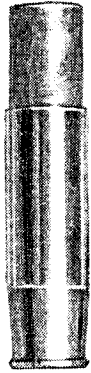

88622



SS648



52171



142069

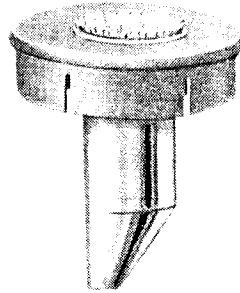

86193

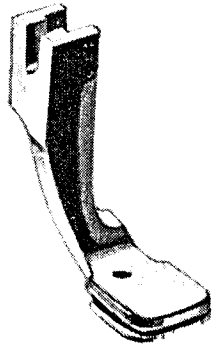

20340

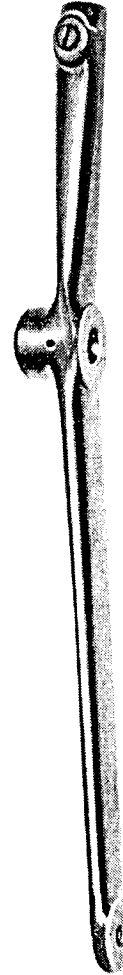

12415



139623



16586



62920



PLATE 7699—FULL SIZE

24443

12436



12435

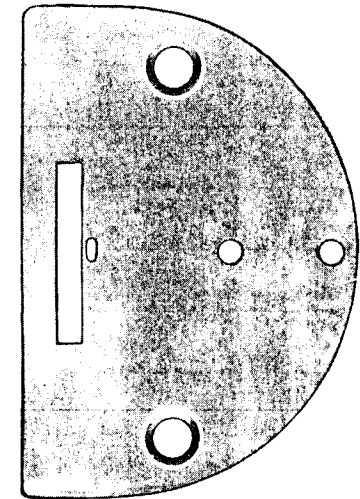
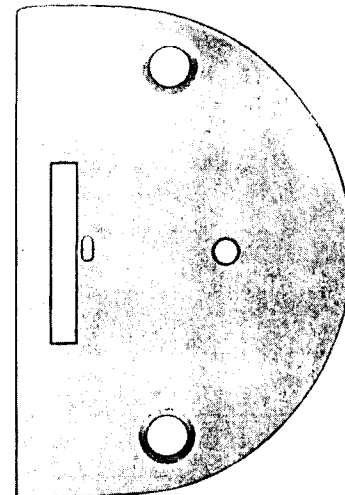

PLATE 7703—FULL SIZE

120063

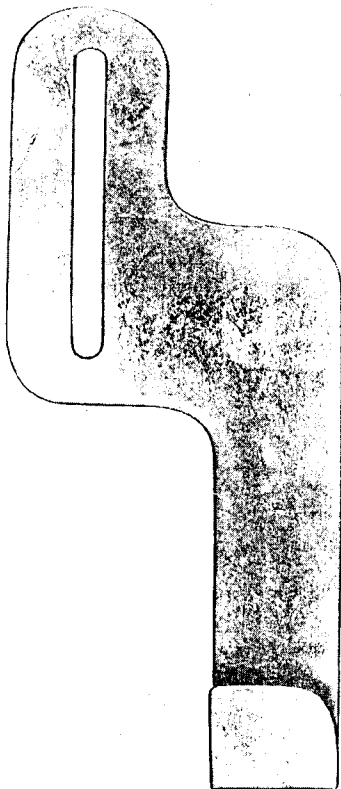
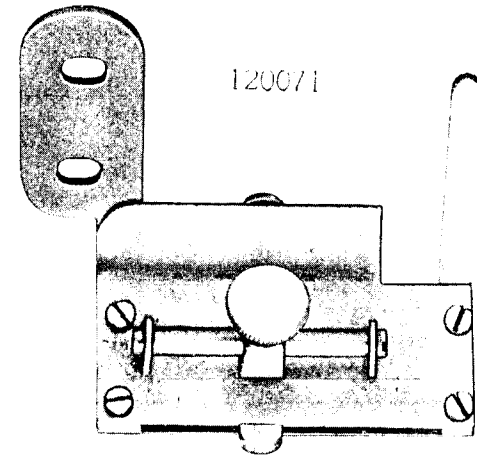

PLATE 7704—FULL SIZE



120071

120067

120068

120069

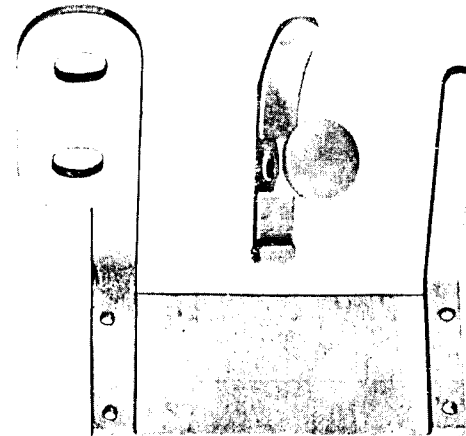

1423

120070

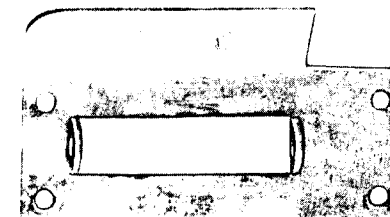

1423





PLATE 7708—ONE-HALF SIZE

26063

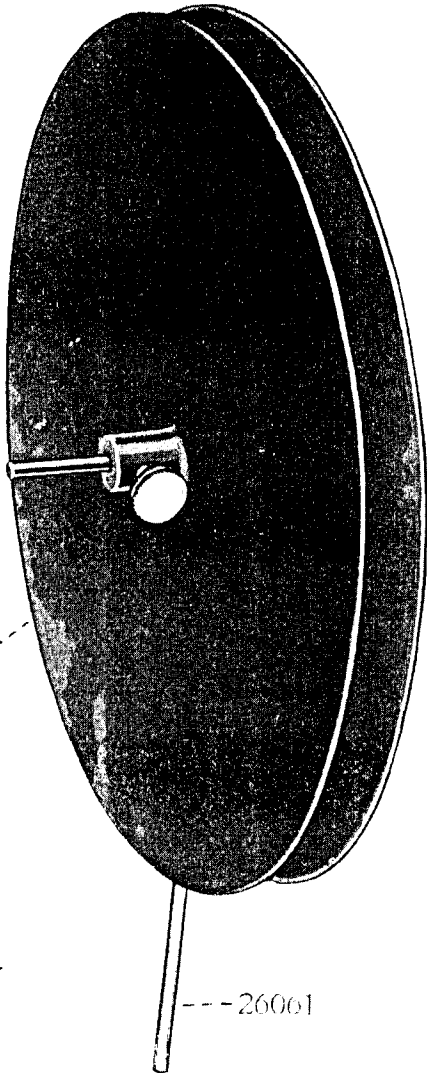

26062

26061

225401

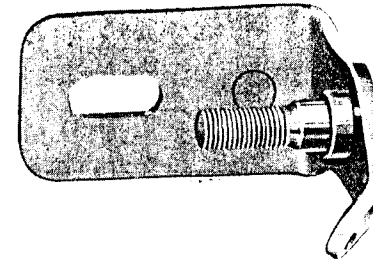

225402

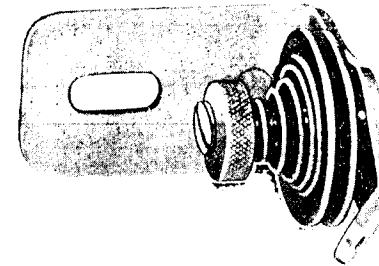

200082



202104



2102

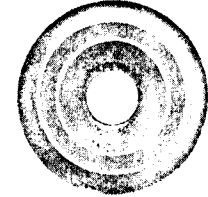

202407



201499



201572



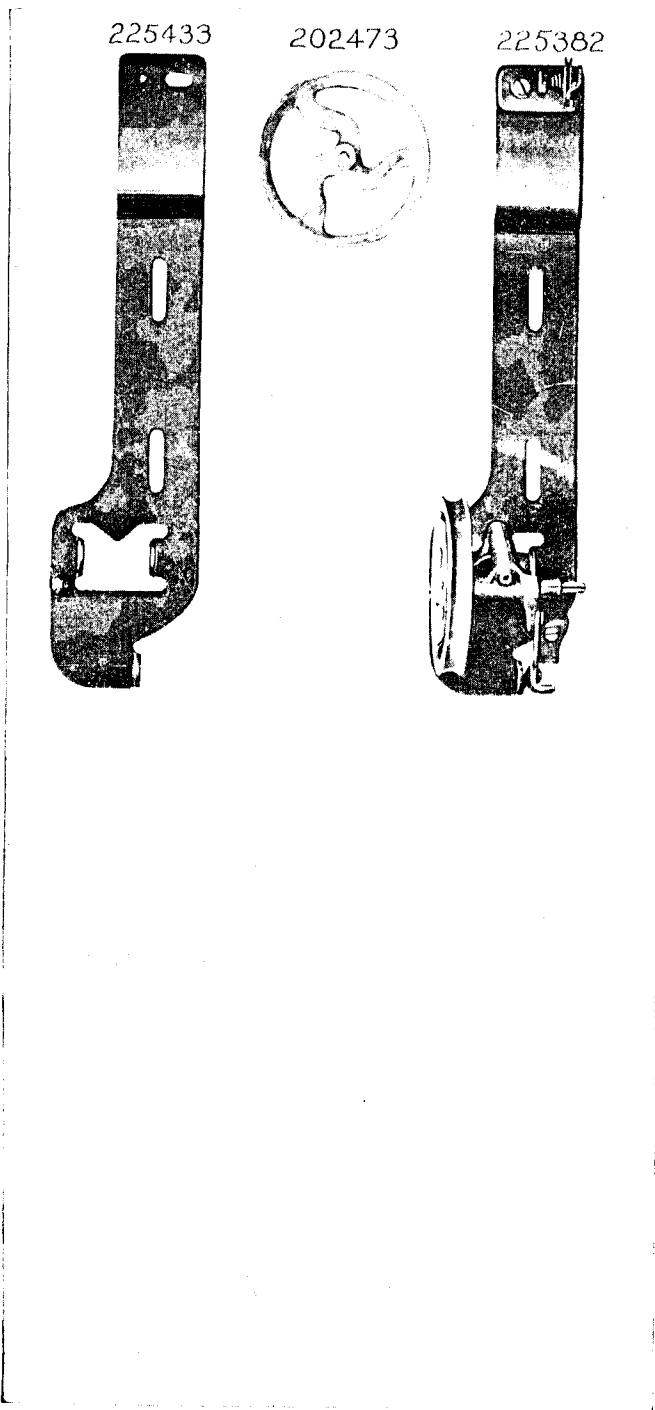
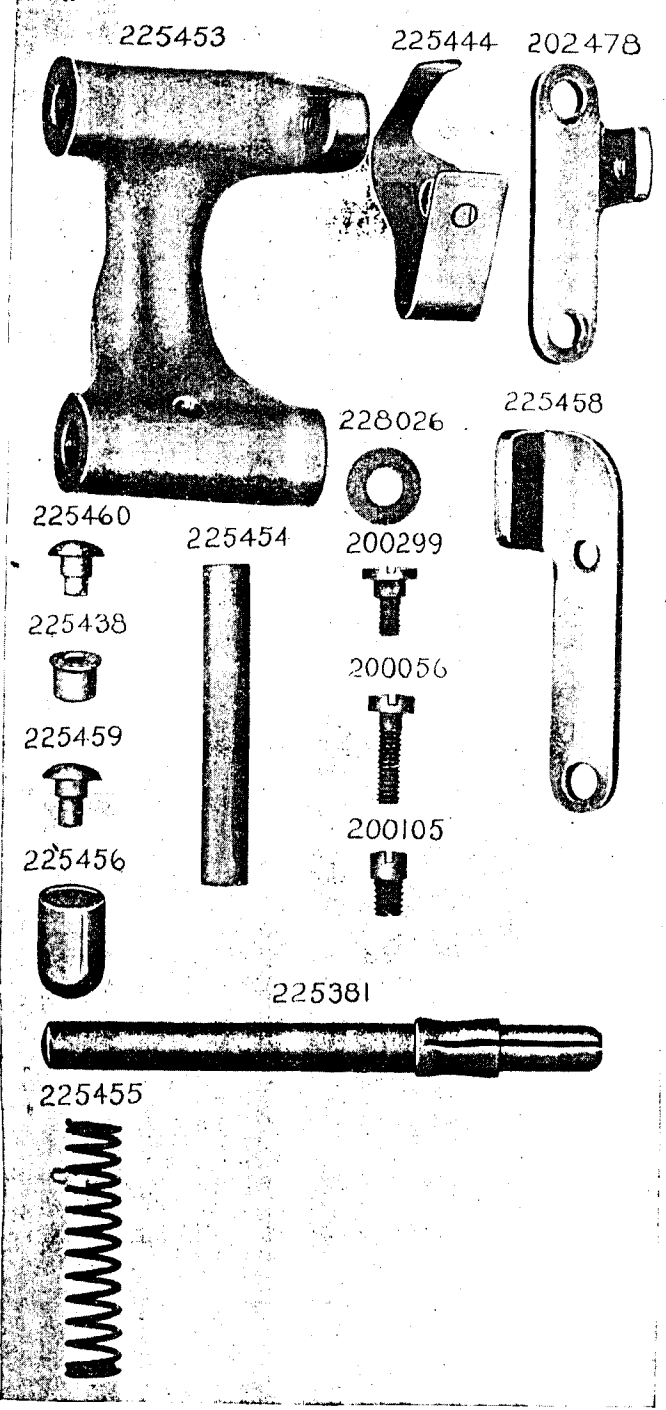

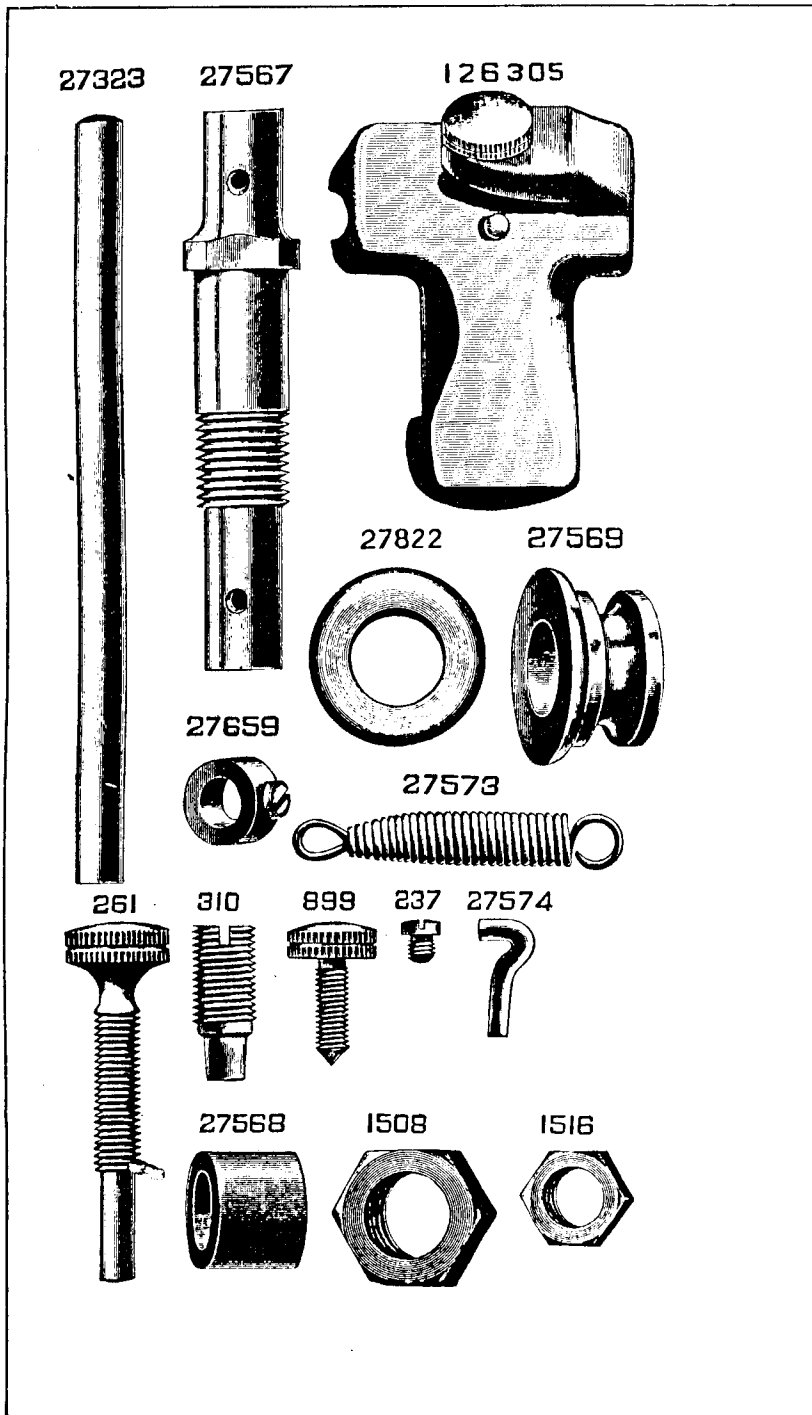

ILLUSTRATED  
LIST OF PARTS

FOR

Nos. 96K40 to 96K45,  
96K49 and 96K51 MACHINES

## CONTENTS

---

	Page
Parts, complete, for 96K40 Machine (obsolete) ... ..	73
"    "    " 96K41 " ( " ) ... ..	81
"    "    " 96K42 " ... ..	89
"    "    " 96K43 " ... ..	97
"    "    " 96K44 " ... ..	105
"    "    " 96K45 " ... ..	113
" Special to 96K49 Machine ... ..	88
"    "    " 96K51 " ... ..	80
Accessories ... ..	125
Attachments ... ..	129
Bobbin Winders ... ..	126
Iron Base ... ..	125
Knee Lifter ... ..	137
Knife Grinder ... ..	139
Numerical List of Parts ... ..	141
Tape Holder ... ..	125
Thread Unwinder ... ..	140

# INSTRUCTIONS FOR ORDERING

In ordering from this List, the prefix and affix letters with the part number **MUST BE** quoted exactly as they are shown in the first column.

A number always indicates the same part in whatever List it may appear, or for whatever machine.

The affix letters (where shown) indicate the style of finish, as follows :—

- A. Hardened, Polished, Nickel Plated and Buffed.
- A.A. Buffed and Chromium Plated.
- A.B. Hardened, Polished, Buffed and Chromium Plated.
- A.C. Brown Baking Enamel Finish.
- A.D. Grey Baking Enamel Finish.
- A.E. Hardened, Bright Rumbled and Nickel Plated.
- A.F. Hardened, Bright Rumbled and Nickel Plated, Bright Rumbled and Chromium Plated.
- A.J. Polished, Nickel Plated and Chromium Plated.
- A.K. Hardened, Polished, Nickel Plated and Chromium Plated.
- A.L. Heat Treated for Toughness.
  - B. Polished, Nickel Plated and Buffed.
  - C. Hardened only.
- C.R. Hardened and Merlized.
  - D. Polished only.
  - E. Soft, not Polished.
  - F. Hardened and Polished.
- F.J. Hardened, Polished and Nickel Plated.
- G. Bright Rumbled and Nickel Plated.
- H. Blued.
- J. Nickel Plated only.
- K. Hardened and Nickel Plated.
- L. Brass Plated.
- M. Oxidized.
- N. Japanned, Dull.
- P. Japanned, Bright.
- P.P. Wrinkle Finish.
- R. Merlized.
- S. Cadmium Plated.
- T. Copper Plated.
- T.A. Hardened, Polished, Copper and Nickel Plated and Buffed.
- T.B. Copper and Nickel Plated and Polished.
- T.J. Copper and Nickel Plated only.
- T.K. Hardened, Copper and Nickel Plated.
- T.L. Copper and Brass Plated.
- T.M. Copper Plated and Oxidized.
  - U. Zinc Plated.
  - V. Silver Plated.
- W. Polished and Nickel Plated.
- X. Black Oxide for Iron and Steel.
- X.C. Hardened and Black Oxide for Iron and Steel.
- Y. Black Nickel Plated only.
- Z. Chromium Plated.
  - Z.A. Hardened, Polished, Nickel Plated, Buffed and Chromium Plated.
  - Z.B. Polished, Nickel Plated, Buffed and Chromium Plated.
  - Z.C. Hardened and Chromium Plated.
  - Z.D. Polished and Chromium Plated.
  - Z.G. Bright Rumbled, Nickel Plated, Bright Rumbled and Chromium Plated.
- Z.J. Nickel and Chromium Plated.
- Z.T. Copper and Chromium Plated.

Parts marked with an asterisk (\*) are furnished only when the repairs are made at Factory.

## PARTS COMPLETE

FOR

### No. 96K40 MACHINE (obsolete)

For Cloaks, Clothing and other work in Cloth. Maximum Stitch 5 to the inch Drop Feed. Knee Lifter.

No.	Plate	
*127328	—	Arm with two <del>50015</del> ... ..

NOTE.— Due to the accuracy required for gear alignment, Arm cannot be supplied separately and can only be sent out as a unit, Arm and Bed assembled.

16532	2032	Arm Dowel Pin (2) ... ..
52182	2066	" Oil Tube with 52184, for oiling 52205 ... ..
52183	2064	" " " " 52184, " " 52024 ... ..
52180	2066	" " " (long) with 52184, for oiling 52022 ... ..
52185	2066	" " " (short) " 42367, " " 52022 ... ..
142087	—	" " " with Hole Cover and Holder ... ..
142069	2545	" " " 142087 with 52150, for oiling 127072 and 127074
<del>50015</del>	2033	" " " for oiling 127058 (2) ... ..
52150	2039	" " " Packing (braided cotton) for 142069 ... ..
42367	2064	" " " " ( " " ) " 52185 ... ..
52184	2064	" " " " (cotton wick) for 52180, 52182, 52183, and 127191
116e	1324	" Screw (back) (2) ... ..
854e	2035	" " (front) (2) ... ..
127047	1815	Arm Shaft (horizontal) ... ..
88615	—	" " ( " ) 127047 with 127253 ... ..
127072	2039	" " ( " ) Bevel Gear with two 1036c ... ..
127070	2029	" " ( " ) " " Case (two pieces) with 121e
121e	1324	" " ( " ) " " " Screw ... ..
1036c	2035	" " ( " ) " " Set Screw ... ..
52191	2040	" " ( " ) Flanged Bushing (back) ... ..
52192	—	" " ( " ) " " ( " ) 52191 with 52193 and 52194
52193	2040	" " ( " ) " " ( " ) Oil Pad (braided cotton)
52194	2064	" " ( " ) " " ( " ) Oil Pad (felt)
446c	1324	" " ( " ) " " ( " ) Set Screw ... ..
52195	2040	" " ( " ) " " (front) ... ..
52196	—	" " ( " ) " " ( " ) 52195 with 52193 and 52194

No.	Plate	
52194	2064	<b>Arm Shaft</b> (horizontal) Flanged Bushing (front) Oil Pad (felt)
52193	2040	" " ( " ) " " ( " ) " "
		(braided cotton)
435c	1324	" " ( " ) " " ( " ) Set Screw ...
68350	2039	" " ( " ) Front Bezing Oil Cup (spring lid) ...
144d	1324	" " ( " ) Screw ...
127058	2028	" " (upright) ...
127073	2039	" " ( " ) Bevel Gear (lower) with two 1259c ...
1259c	2035	" " ( " ) " " ( " ) Set Screw ...
127074	2039	" " ( " ) " " (upper) with two 1259c ...
1259c	2035	" " ( " ) " " ( " ) Set Screw ...
52492	2039	" " ( " ) Bushing (lower) ...
432c	1324	" " ( " ) " ( " ) Set Screw ...
52493	2039	" " ( " ) " (upper) ...
435c	1324	" " ( " ) " ( " ) Set Screw ...
127146	2066	" Side Cap ...
219d	1324	" " " Screw ...
127079	2028	" " Cover ...
50053d	2035	" " " Thumb Screw ...
52239	2064	" Spool Pin and Thread Eyelet ...
8879	1316	" " " Washer (cloth) ...
127192	2064	<b>Arm Top Cover</b> ...
127193	2064	" " " 127192 with 52183, 52239, 127187 and 127255
52183	2064	" " " Oil Tube with 52184 ...
52184	2064	" " " " " Packing (cotton wick) ...
127187	2040	" " " " " (bent) with 42367 ...
42367	2064	" " " " " Packing (braided cotton) ...
127255	2378	" " " Positioning Disc ...
158j	1324	" " " Screw ...
150459	2064	" " " Tension Bracket with 460c ...
52183	2064	" " " " " Oil Tube with 52184 ...
52184	2064	" " " " " " " Packing (cotton wick) ...
127187	2040	" " " " " (bent) with 42367 ...
42367	2046	" " " " " Packing (braided cotton) ...
158j	1324	" " " " " Screw ...
52239	2064	" " " " " Spool Pin ...
8879	1316	" " " " " Washer (cloth) ...
2455	1688	" " " " " Disc ...
41593	1316	" " " " " Spring ...
41594	1316	" " " " " Stud ...
460c	1324	" " " " " Set Screw ...
41595	1316	" " " " " Thread Guide ...

No.	Plate	
150460	2064	<b>Arm Top Cover Tension Bracket</b> , complete, Nos. 41593 to 41595, 52183, 52239, 127187, 127255, 150459 and two 2455
		<i>NOTE.</i> —No. 150460 is supplied with this machine unless No. 427493 is specified on order.
<del>142033</del>		
<del>52487</del>	2065	<b>Balance Wheel</b> (power, disc), 2 $\frac{3}{16}$ " pulley, with two 448c ...
52081		" " (stand, heavy rim) 2 $\frac{1}{16}$ " pulley, with two 448c ...
<del>52063</del>	2029	" " Oil Cover ...
2100	1324	" " " " Screw ...
448c	1324	" " Set Screw ...
		<i>NOTE.</i> —No. 52487 is supplied with this machine unless otherwise specified on order.
*52383		<b>Bed</b> ...
		<i>NOTE.</i> —Due to the accuracy required for gear alignment, Bed cannot be supplied separately and can only be sent out as a unit, Arm and Bed assembled.
12431		<b>Bed Slide</b> ...
12432	2028	" " complete, Nos. 4307, 12431 and two 725c ...
4307	2028	" " Spring ...
725c	1324	" " " Screw ...
52051		<b>Face Plate</b> ...
176d	559	" " Screw ...
52053	2030	" " Thread Guard (lower) ...
226d	1324	" " " " ( " ) Screw ...
52170		" " " " (upper) ...
226d	1324	" " " " ( " ) Screw ...
50190d	2035	" " Thumb Screw ...
52052	2028	<b>Face Plate</b> , complete, Nos. 52051, 52053, 52170 and two 226d ...
52452	2028	<b>Feed Bar</b> ...
313c	1324	" " Screw Centre (2) ...
1519c	2034	" " " " Nut (2) ...
52165	2066	" Connecting Link ...
375c	1324	" " " Hinge Screw ...
1518c	2034	" " " " Nut ...
52073	2032	" " " Stud ...
50083c	2035	" " " " Set Screw ...
44136	1510	<b>Feed Dog</b> for tailor work ...
12457	2036	" " " cloth, 16 teeth (16 teeth to the inch) ...
12450	2036	" " " " 11 " (18 " " " " ) ...
20158	2030	" " " shirt work, 17 teeth (16 teeth to the inch) ...
20162	2036	" " " " bevelled for hemmer, 17 teeth (16 teeth to the inch) ...
12481	2036	" " " general work, 18 teeth (16 teeth to the inch) ...
50117c	2035	" " Screw (2) ...
		<i>NOTE.</i> —Feed Dog No. 44136 is sent with this machine unless otherwise specified on order.

No.	Plate	
127202	—	<b>Feed and Feed Lifting Eccentric</b> with 448c, 1299c, 52210 and 52211
127225	—	" " " " " 127202 with 127152
52210	1503	" " " " " Lubricating Pad (wood, long)
52211	1503	" " " " " " " ( " short)
1299c	2040	" " " " " Position Screw
448c	1324	" " " " " Set Screw
127152	2066	" " " " " Sleeve
20284	2029	<b>Feed Forked Connection</b>
52393	—	" " " " 20284 with 375c, 1518e and 52165
375c	1324	" " " " Hinge Screw
1518e	2034	" " " " " Nut
52384	2029	<b>Feed Lifting Rock Shaft</b>
127156	2065	" " " " " Connecting Rod with 127157 and two 966e
*127157	—	" " " " " " " Cap
966e	2035	" " " " " " " Screw
375c	1324	" " " " " " " Hinge Screw
1518e	2034	" " " " " " " " Nut
12376	2032	" " " " " Crank with 157c and 1813
157c	1324	" " " " " " Clamping Screw
1813	2034	" " " " " " Roller and Stud
50191c	2034	" " " " " Screw Centre (2)
1513j	1317	" " " " " " Nut (2)
52385	—	<b>Feed Lifting Rock Shaft, complete, Nos. 12376 and 52384</b>
52074	2033	<b>Feed Regulator</b> with 50083c
52118	—	" " " 52074 with 52073
52093	—	" " " 52118 with 818d
1128e	2035	" " " Hinge Screw
818d	2035	" " " Thumb Screw
52384	2029	<b>Feed Rock Shaft</b>
29633	2032	" " " " Crank with 157c
157c	1324	" " " " " Clamping Screw
50191c	2034	" " " " " Screw Centre (2)
1513j	1317	" " " " " " Nut (2)
142033	—	Machine Pulley (disc) "V" belt groove (outside diam. of belt groove 2.9"), with two 435al
52081	—	Machine Pulley (stand, heavy rim), 2 1/8" pulley, with two 448c
52063	2029	Machine Pulley Oil Cover
210d	1324	" " " " " Screw
448c	1324	" " " " " Set Screw for 52081
435al	1324	" " " " " " 142033

Note—No. 142033 is supplied with machine unless otherwise specified on order

No.	Plate	
1133c	2035	<b>Needle Bar</b> Bushing (lower) Set Screw
52014	2039	" " " (upper)
1133c	2035	" " " ( " ) Set Screw
52205	2066	" " " Connecting Link with 52207
52206	—	" " " " 52205 with 24041
775c	2035	" " " " " Cap Screw
52207	—	" " " " " Lubricating Pad (wood)
24041	2066	" " " " " Stud with 207 1/2
207 1/2	1688	" " " " " Clamping Screw
127253	2373	" " " Crank with 1036al, 1037al and 1065al
1065al	2035	" " " " " Position Screw
127323	—	" " " " " Thread Guard
229d	2035	" " " " " " Screw
52307	2039	" " " " " Clamp with 51460f
51460f	2378	" " " " " Screw
*52201	2064	<b>Oil Absorbent Wick</b>
52202	2064	" " " " 52201, with 52203, for lower cavity in head of arm
*52203	2040	" " " " " Wire
127191	—	<b>Oil Tube, with 52184</b>
127091	2040	" " " Bracket
127092	—	" " " " 127091, with 127191, for oiling 52165
52184	2064	" " " " " Packing (cotton wick)
12391	2028	<b>Presser Bar</b> (hollow)
52338	1316	" " " Guide Bracket with 223c and 453c
453c	1316	" " " " " Set Screw
52016	1316	" " " " " Lifter
689c	1316	" " " " " Screw
1520r	1317	" " " " " " Nut
12327	1316	" " " " " Lifting and Releasing Lever Bracket
127108	2029	" " " " " Spring
11170	1316	" " " " " Washer
7298	2032	<b>Presser Foot Hinge Pin</b>
19334	—	" " " " " Plate
19335	—	" " " " " Shank
19336	2030	<b>Presser Foot</b> (hinged), complete, Nos. 7298, 19334 and 19335 for 44136
20458	2030	" " " " " for 44136
12142	2030	" " " " " 20158
12260	2030	" " " " " 12450
12474	2030	" " " " " 20162
190d	1324	" " " " " Screw

NOTE.—Presser Foot No. 20458 is sent with this machine unless otherwise specified on order.

No.	Plate	
688j	1324	<b>Pressure Regulating Thumb Screw</b> ... ..
127095	2039	<b>Rotating Hook</b> with three 1253c ... ..
127096	"	" " 127095 with 127102 and four 1053e ... ..
127239	"	" " 127096 " 40274, 127242 and three 1367d ... ..
127097	"	" " 127096 " 40274 and three 1367d (for agents only) ... ..
127240	"	" " 127239 " 52237 ... ..
40264	2032	" " Bobbin ... ..
52235	"	" " Case ... ..
52236	"	" " " " 52235 with 591f, 1380d and 40394 ... ..
40393	"	" " " " Hinge, Nos. 2974, 40392 and 125320 ... ..
127242	"	" " " " Holder ... ..
52018	2032	" " " " " Position Bracket ... ..
704j	1324	" " " " " " Screw ... ..
40392	2032	" " " " Latch ... ..
125320	2066	" " Bobbin Case Latch Lever ... ..
2974	2032	" " " " " Fulcrum Pin ... ..
2975	2032	" " " " " Spring ... ..
592e	1324	" " " " " Stop Screw ... ..
591f	1324	" " " " " Tension Regulating Screw ... ..
40394	2032	" " " " " Spring ... ..
1380d	2035	" " " " " " Screw ... ..
52237	2032	" " " " complete, Nos. 592e, 2975, 40393 and 52236 ... ..
127241	"	" " " " 52237 with 127242 (for agents only) ... ..
40274	2032	" " Section ... ..
1367d	2035	" " " Screw ... ..
1253c	2035	" " Set Screw ... ..
127059	2065	" " Shaft ... ..
127073	2039	" " " Bevel Gear with two 1259c ... ..
127007	2029	" " " " Case (two pieces) with 121e and 50234d ... ..
50234d	2035	" " " " " Plug Screw ... ..
121e	1324	" " " " " Screw ... ..
1259c	2035	" " " " " Set Screw ... ..
127004	2039	" " Bushing (back) ... ..
127043	"	" " " ( " ) 127004 with 52045 ... ..
52045	2032	" " " ( " ) Packing (cotton) ... ..
1143c	2035	" " " ( " ) Set Screw ... ..
127005	2039	" " " (front) ... ..
127044	"	" " " ( " ) 127005 with 52045 ... ..
142008	2373	" " " ( " ) ... ..
144828	—	<b>Rotating Hook</b> with three 1253c ... .. (ton)
144829	—	<b>Rotating Hook</b> 144828 with 270083 and four 1053e ... ..
144830	—	<b>Rotating Hook</b> 144829 with 40274, 143346 and three 1367e ... ..
144832	—	<b>Rotating Hook</b> 144830 with 52237 ... ..
144831	—	<b>Rotating Hook</b> 144829 with 40274 and three 1367e (for agents only) ... ..

No.	Plate	
52337	1316	<b>Slack Thread Regulator</b> ... ..
223c	1316	" " " Set Screw ... ..
2102	2032	<b>Tension Disc</b> ... ..
1560c	2034	" Regulating Thumb Nut ... ..
32572	2032	" Releasing Disc ... ..
43944	1316	" " Lever ... ..
12398	1316	" " " Hinge Pin ... ..
12329	1316	" " " Spring ... ..
32574	2032	" " Pin ... ..
2103	2032	" Spring ... ..
*50304c	2034	" Stud ... ..
52098	—	" Stud 50304c with 1560c ... ..
50305c	2035	" " Set Screw ... ..
52397	—	<b>Tension</b> , complete, Nos. 2103, 32572, 32574, 52083, 52098, 52394 and two 2102 ... ..
52027	2032	<b>Thread Guard</b> (side of arm) ... ..
52454	2030	" Retainer ... ..
624c	2035	" " Set Screw ... ..
52215	—	<b>Thread Take-up</b> , complete, Nos. 11204, 52025 and 52217 ... ..
52216	2373	<b>Thread Take-up Crank</b> ... ..
52217	—	" " " 52216 with 775c and 52206 ... ..
1037al	2035	" " " Position Screw ... ..
1036al	2035	" " " Set Screw ... ..
52022	1503	<b>Thread Take-up Lever</b> with 52130 ... ..
52023	2039	" " " Hinge Pin ... ..
52024	2039	" " " Link ... ..
11204	2033	" " " " Hinge Pin ... ..
435c	1324	" " " " " Set Screw ... ..
52130	—	" " " Thread Eyelet Bushing ... ..
52025	—	<b>Thread Take-up Lever</b> , complete, Nos. 52022 to 52024 ... ..
52394	2039	<b>Thread Take-up Spring</b> ... ..
52083	2032	" " " Regulator with 50305c ... ..
448c	1324	" " " " Set Screw ... ..
44137	1510	<b>Throat Plate</b> , large needle hole, for 44136 ... ..
12411	2036	" " " " " 12457 ... ..
19409	2036	" " " " " 20162 ... ..
19410	2036	" " small " " " 20162 ... ..
12482	—	" " large " " " 12481 ... ..
12483	2036	" " small " " " 12481 ... ..
12464	2544	" " large " " " 12450 ... ..



No.	Plate	
12451	2544	Throat Plate, small needle hole, for 12450 ...
19418	2544	" " large " " " 20158 ...
19419	2544	" " small " " " 20158 ...
691f	1324	" " Screw (2) ...

NOTE.—Throat Plate No. 44137 is sent with this machine unless otherwise specified on order.

139622	—	Drip Pan with four $\frac{3}{4}$ " wire nails ...
--------	---	---

## PARTS SPECIAL TO No. 96K51 MACHINE

For Cloaks, Clothing and other work in Cloth. Maximum Stitch 5 to the inch. Drop Feed. Knee Lifter.

This machine is the same as No. 96K40 with the following exceptions:—

No.	Plate	
88621	2545	Needle Bar (hollow) ...
106058	2545	" " Bushing (lower) ...
88622	2545	" Clamp with SS648c ...
SS648c	2545	" " Screw ...
19336	2030	Presser Foot (hinged), complete, Nos. 7298, 19334 and 19335, for 44136 ...
7171	2545	Thread Eyelet ...

## PARTS COMPLETE

FOR

## No. 96K41 MACHINE (obsolete)

For Cloaks, Clothing, Overalls and other work in Cloth. Maximum Stitch 5 to the inch. Reversible Feed. Knee Lifter.

No.	Plate	
*127329	—	Arm with two 56015 ...

NOTE.—Due to the accuracy required for gear alignment, Arm cannot be supplied separately and can only be sent out as a unit, Arm and Bed assembled.

16532	2032	Arm Dowel Pin (2) ...
52182	2066	" Oil Tube, with 52184, for oiling 52205 ...
52183	2064	" " " " 52184, " " 52024 ...
52180	2066	" " " (long), with 52184, for oiling 52022 ...
52185	2066	" " " (short), with 42367, for oiling 52022 ...
142087	—	" " " with Hole Cover and Holder ...
142069	2545	" " " 142087, with 52150, for oiling 127072 and 127074 ...
<del>56015</del>	2033	" " " for oiling 127058 (2) ...
52150	2039	" " " Packing (braided cotton) for 142069 ...
42367	2064	" " " " ( " " ) " 52185 ...
52184	2064	" " " " (cotton wick) for 52180, 52182, 52183, and 127191 ...
116e	1324	" Screw (back) (2) ...
854e	2035	" " (front) (2) ...

52382	2372	Arm Shaft (horizontal) ...
88616	—	" " ( " ) 52382 with 127253 for 52081 and 52187 ...

NOTE.—No. 88616 is supplied with this machine unless otherwise specified on order.

52400	2372	Arm Shaft (horizontal) ...
88617	—	" " ( " ) 52400 with 127253 for 56017 ...
127072	2039	" " ( " ) Bevel Gear with two 1036c ...
127070	2029	" " ( " ) " " Case (two pieces) with 121e ...
121e	1324	" " ( " ) " " Screw ...
1036c	2035	" " ( " ) " " Set Screw ...
52191	2040	" " ( " ) Flanged Bushing (back) ...
52192	—	" " ( " ) " " ( " ) 52191 with 52193 and 52194 ...

No.	Plate	
52401	1529	<b>Arm Shaft</b> (horizontal) Flanged Bushing (back) for 52405 ...
52193	2040	" " ( " ) " " ( " ) Oil Pad ... (braided cotton)
52194	2064	" " ( " ) " " ( " ) Oil Pad (felt)
446c	1324	" " ( " ) " " ( " ) Set Screw ...
52195	2040	" " ( " ) " " (front) ...
52196	—	" " ( " ) " " ( " ) 52195 with 52193 and 52194
52193	2040	" " ( " ) " " ( " ) Oil Pad (braided cotton)
52194	2064	" " ( " ) " " ( " ) Oil Pad (felt)
435c	1324	" " ( " ) " " ( " ) Set Screw ...
68350	2039	" " ( " ) Front Bearing Oil Cup (spring lid) ...
144d	1324	" " ( " ) Screw ...
127058	2028	" " (upright) ...
127073	2039	" " ( " ) Bevel Gear (lower) with two 1259c ...
1259c	2035	" " ( " ) " " ( " ) Set Screw ...
127074	2039	" " ( " ) " " (upper) with two 1259c ...
1259c	2035	" " ( " ) " " ( " ) Set Screw ...
52492	2039	" " ( " ) Bushing (lower) ...
432c	1324	" " ( " ) " " ( " ) Set Screw ...
52493	2039	" " ( " ) " " (upper) ...
435c	1324	" " ( " ) " " ( " ) Set Screw ...
127146	2066	" Side Cap ...
219d	1324	" " " Screw ...
127079	2028	" " Cover ...
50053d	2035	" " " Thumb Screw ...
52239	2064	" Spool Pin and Thread Eyelet ...
8879	1316	" " " Washer (cloth) ...
127192	2064	<b>Arm Top Cover</b> ...
127193	2064	" " " 127192 with 52183, 52239, 127187 and 127255
52183	2064	" " " Oil Tube with 52184 ...
52184	2064	" " " " " Packing (cotton wick) ...
127187	2040	" " " " " (bent) with 42367 ...
42367	2064	" " " " " Packing (braided cotton) ...
127255	2378	" " " Positioning Disc ...
158j	1324	" " " Screw ...
150459	2064	" " " Tension Bracket with 460c ...
52183	2064	" " " " " Oil Tube with 52184 ...
52184	2064	" " " " " " " Packing (cotton wick)
127187	2040	" " " " " (bent) with 42367 ...
42367	2064	" " " " " " " Packing (braided cotton)
158j	1324	" " " " " Screw ...
52239	2064	" " " " " Spool Pin ...
8879	1316	" " " " " " " Washer (cloth) ...

No.	Plate	
2455	1688	<b>Arm Top Cover Tension Disc</b> ...
41593	1316	" " " " Spring ...
41594	1316	" " " " Stud ...
460c	1324	" " " " " Set Screw ...
41595	1316	" " " " Thread Guide ...
150460	2064	<b>Arm Top Cover Tension Bracket</b> , complete, Nos. 41593 to 41595, 52183, 52239, 127187, 127255, 150459 and two 2455

NOTE:—No. ~~150460~~ is supplied with this machine unless No. ~~127193~~ is  
~~127193~~ specified on order. ~~150460~~

~~142033~~

52187	2065	<b>Balance Wheel</b> (power, disc) 2 3/8" pulley, with two 448c
<del>52001</del>	—	" " (stand, heavy rim) 2 1/8" pulley, with two 448c
<del>56017</del>	2030	" " 2 1/4" pulley for 52405 ...
<del>52003</del>	2029	" " Oil Cover ...
<del>2104</del>	1324	" " " " Screw ...
<del>448c</del>	1324	" " " " Set Screw ...

NOTE:—No. ~~52187~~ is supplied with this machine unless otherwise specified  
on order.

*52383	—	<b>Bed</b> ...
--------	---	----------------

NOTE:—Due to the accuracy required for gear alignment, Bed cannot be supplied  
separately and can only be sent out as a unit, Arm and Bed assembled.

12431	—	<b>Bed Slide</b> ...
12432	2028	" " complete, Nos. 4307, 12431 and two 725c ...
4307	2028	" " Spring ...
725c	1324	" " " Screw ...

256w	2035	<b>Clamp Stop Motion Clamp Screw</b> ...
248a	2035	" " " " Stop Screw ...
2020	2033	" " " " Washer ...
*52403	—	" " " Flanged Bushing ...
52404	1529	" " " " " 52403 with two 50311al
2022	2033	" " " " " Pin ...
50311al	2035	" " " " " Set Screw ...
52405	—	<b>Clamp Stop Motion</b> , complete, Nos. 248a, 256w, 2020 and 52404, for 56017 ...

52051	—	<b>Face Plate</b> ...
176d	559	" " Screw ...
52053	2030	" " Thread Guard (lower) ...
226d	1324	" " " " ( " ) Screw ...
52170	—	" " " " (upper) ...
226d	1324	" " " " ( " ) Screw ...
50190d	2035	" " Thumb Screw ...
52052	2028	<b>Face Plate</b> , complete, Nos. 52051, 52053, 52170 and two 226d ...

No.	Plate						
52452	2028	<b>Feed Bar</b>	...	...	...	...	...
313c	1324	" "	Screw Centre (2)	...	...	...	...
1519e	2034	" "	" " Nut (2)	...	...	...	...
52165	2066	" "	Connecting Link	...	...	...	...
375c	1324	" "	" " Hinge Screw	...	...	...	...
1518e	2034	" "	" " " " Nut	...	...	...	...
52073	2032	" "	" " Stud	...	...	...	...
50083c	2035	" "	" " " " Set Screw	...	...	...	...
26603	1529	<b>Feed Dog</b>	...	...	...	...	...
28360	1529	" "	(15 conical teeth)	...	...	...	...
121446	2376	" "	(spiked teeth)	...	...	...	...
50117c	2035	" "	" " Screw (2)	...	...	...	...
<i>NOTE.—Feed Dog No. 26603 is sent with this machine unless otherwise specified on order.</i>							
127324	2373	<b>Feed and Feed Lifting Eccentric</b>	with 52210, 52211 and two	448al			
127325	—	" "	" " " " " 127324 with 127152	...			
52210	1503	" "	" " " " " Lubricating Pad (wood, long)	...			
52211	1503	" "	" " " " " " " ( " short)	...			
448al	1324	" "	" " " " " Set Screw	...			
127152	2066	" "	" " " " " Sleeve	...			
52407	2029	<b>Feed Forked Connection</b>	...	...	...	...	...
52451	—	" "	" " " " 52407 with 375c, 1518e and 52165	...			
375c	1324	" "	" " " " Hinge Screw	...			
1518e	2034	" "	" " " " " " Nut	...			
52384	2029	<b>Feed Lifting Rock Shaft</b>	...	...	...	...	...
127156	2065	" "	" " " " " Connecting Rod with 127157 and two	966e			
*127157	—	" "	" " " " " " " Cap	...			
966e	2035	" "	" " " " " " " Screw	...			
375c	1324	" "	" " " " " " " Hinge Screw	...			
1518e	2034	" "	" " " " " " " " " Nut	...			
12376	2032	" "	" " " " " Crank with 157c and 1813	...			
157c	1324	" "	" " " " " " Clamping Screw	...			
1813	2034	" "	" " " " " " Roller and Stud	...			
50191c	2034	" "	" " " " " " Screw Centre (2)	...			
1513j	1317	" "	" " " " " " Nut (2)	...			
52385	—	<b>Feed Lifting Rock Shaft, complete</b>	Nos. 12376 and 52384	...			
50338e	2034	<b>Feed Regulating Screw Stud</b>	...	...	...	...	...
56032	1502	" "	" " " " " Head with 56033	...			
50193j	2035	" "	" " " " " " Cap Screw	...			
56033	1503	" "	" " " " " " Stop Pin	...			
56034	1502	" "	" " " " " " Lock Pin	...			
56035	1502	" "	" " " " " " Spring	...			

No.	Plate						
52408	1502	<b>Feed Regulator</b>	with 50083c	...	...	...	...
52411	—	" "	" " 52408 with 52073	...	...	...	...
1128e	2035	" "	" " Hinge Screw	...	...	...	...
52409	1502	<b>Feed Reverse Lever</b>	with 158e and 51846	...	...	...	...
50339d	2034	" "	" " " " Hinge Screw	...	...	...	...
158e	1324	" "	" " " " " Clamping Screw	...	...	...	...
52410	1502	" "	" " " " " Friction Washer	...	...	...	...
51846	2034	" "	" " " " " Roller and Stud	...	...	...	...
52386	2029	<b>Feed Rock Shaft</b>	...	...	...	...	...
29633	2032	" "	" " " " Crank with 157c	...	...	...	...
157e	1324	" "	" " " " " Clamping Screw	...	...	...	...
50191e	2034	" "	" " " " " Screw Centre (2)	...	...	...	...
1513j	1317	" "	" " " " " " Nut (2)	...	...	...	...
52387	—	<b>Feed Rock Shaft, complete</b>	Nos. 29633 and 52386	...	...	...	...
25866	2031	<b>Guide</b>	...	...	...	...	...
50190b	2035	" "	" " Thumb Screw	...	...	...	...
127088	2040	<b>Needle Bar</b>	(hollow)	...	...	...	...
127322	—	" "	" " 127088 with 229d, 52307 and 127323	...	...	...	...
127230	2373	" "	" " Bushing (lower)	...	...	...	...
1133c	2035	" "	" " " " ( " ) Set Screw	...	...	...	...
52014	2039	" "	" " " " (upper)	...	...	...	...
1133c	2035	" "	" " " " ( " ) Set Screw	...	...	...	...
52205	2066	" "	" " " " Connecting Link with 52207	...	...	...	...
52206	—	" "	" " " " " 52205 with 24041	...	...	...	...
775e	2035	" "	" " " " " Cap Screw	...	...	...	...
52207	—	" "	" " " " " Lubricating Pad (wood)	...	...	...	...
24041	2066	" "	" " " " " Stud with 207f	...	...	...	...
207f	F1688	" "	" " " " " Clamping Screw	...	...	...	...
127253	2373	" "	" " " " Crank with 1036al, 1037al and 1065al	...	...	...	...
1065al	2035	" "	" " " " " Position Screw	...	...	...	...
127323	—	" "	" " " " " Thread Guard	...	...	...	...
229d	2035	" "	" " " " " " Screw	...	...	...	...
52307	2039	" "	" " " " " Clamp with 51460f	...	...	...	...
51460f	2378	" "	" " " " " Screw	...	...	...	...
*52201	2064	<b>Oil Absorbent Wick</b>	...	...	...	...	...
52201	—	" "	" " with 52203, for lower cavity in head	...	...	...	...
142033	—	Machine Pulley (disc)	" V " belt groove (outside diam. of belt groove 2.9"), with two 435al	...	...	...	of arm
52081	—	Machine Pulley (stand, heavy rim),	2 1/8" pulley, with two 448c	...	...	...	...
56017	2030	Machine Pulley	2 1/4" pulley, for 52405	...	...	52165	...
52063	2029	" "	" " Oil Cover	...	...	...	...
210d	1324	" "	" " " " Screw	...	...	...	7
448c	1324	" "	" " " " Set Screw	...	...	...	...

Note—No. 142033 is supplied with machine unless otherwise specified on order

No.	Plate	
12391	2028	<b>Presser Bar</b> (hollow) ... ..
52338	1316	" " Guide Bracket with 223c and 453c ... ..
453c	1316	" " " " Set Screw ... ..
52016	1316	" " Lifter ... ..
689c	1316	" " " Screw ... ..
1520r	1317	" " " " Nut ... ..
12327	1316	" " Lifting and Releasing Lever Bracket ... ..
127108	2029	" " Spring ... ..
11170	1316	" " " Washer ... ..
7298	2032	<b>Presser Foot Hinge Pin</b> ... ..
52426	—	" " Plate ... ..
52390	—	" " Shank ... ..
26231	2032	" " Spring ... ..
52427	1529	<b>Presser Foot</b> (spring hinged), complete, Nos. 7298, 26231, 52390 and 52426
190d	1324	" " Screw ... ..
688j	1324	<b>Pressure Regulating Thumb Screw</b> ... ..
127095	2039	<b>Rotating Hook</b> with three 1253c ... ..
127096	—	" " 127095 with 127102 and four 1053e ... ..
127239	—	" " 127096 with 40274, 127242 and three 1367d ... ..
127097	—	" " 127096 with 40274 and three 1367d (for agents only)
127240	—	" " 127239 with 52237 ... ..
40264	2032	" " Bobbin ... ..
52235	—	" " " Case ... ..
52236	—	" " " " 52235 with 591f, 1380d and 40394
40293	—	" " " " Hinge Nos. 2974, 40392 and 125320
127242	2078	" " " " Holder ... ..
52018	2032	" " " " " Position Bracket ... ..
704j	1324	" " " " " " " Screw ... ..
40392	2032	" " " " " Latch ... ..
125320	2066	" " " " " Lever ... ..
2974	2032	" " " " " " Fulerum Pin ... ..
2975	2032	" " " " " Spring ... ..
592e	1324	" " " " " Stop Screw ... ..
591f	1324	" " " " " Tension Regulating Screw ... ..
40394	2032	" " " " " Spring ... ..
1380d	2035	" " " " " " Screw ... ..
52237	2032	" " " " " complete, Nos. 592e, 2975, 40393 and 52236
144828	—	Rotating Hook with three 1253c ... .. agents only)
144829	—	Rotating Hook 144828 with 270083 and four 1053e ... ..
144830	—	Rotating Hook 144829 with 40274, 143346 and three 1367e ... ..
144832	—	Rotating Hook 144830 with 52237 ... ..
144831	—	Rotating Hook 144829 with 40274 and three 1367e (for agents only) ... ..

No.	Plate	
1253c	2035	<b>Rotating Hook</b> Set Screw ... ..
127059	2065	" " Shaft ... ..
127073	2039	" " " Bevel Gear with two 1259c ... ..
127007	2029	" " " " " Case (two pieces) with 121e and 50234d
50234d	2035	" " " " " Plug Screw ... ..
121e	1324	" " " " " Screw ... ..
1259c	2035	" " " " " Set Screw ... ..
127004	2039	" " " " Bushing (back) ... ..
127043	—	" " " " " ( " ) 127004 with 52045 ... ..
52045	2032	" " " " " ( " ) Packing (cotton) ... ..
1143c	2035	" " " " " ( " ) Set Screw ... ..
127005	2039	" " " " " (front) ... ..
127044	—	" " " " " ( " ) 127005 with 52045 ... ..
142008	2373	" " " " " ( " ) Oil Cup ... ..
52045	2032	" " " " " ( " ) Packing (cotton) ... ..
1148c	2035	" " " " " ( " ) Set Screw ... ..
270083	2039	" " Thread Guard ... ..
1053e	2035	" " " " " Screw ... ..
52337	1316	<b>Slack Thread Regulator</b> ... ..
223c	1316	" " " " Set Screw ... ..
2102	2032	<b>Tension Disc</b> ... ..
1560c	2034	" Regulating Thumb Nut ... ..
32572	2032	" Releasing Disc ... ..
43944	1316	" " Lever ... ..
12398	1316	" " " Hinge Pin ... ..
12329	1316	" " " Spring ... ..
32574	2032	" " " Pin ... ..
2103	2032	" Spring ... ..
*50304c	2034	" Stud ... ..
52098	—	" " 50304c with 1560c ... ..
50305c	2035	" " Set Screw ... ..
52397	—	<b>Tension</b> , complete, Nos. 2103, 32572, 32574, 52083, 52098, 52394 and two 2102 ... ..
52027	2032	<b>Thread Guard</b> (side of arm) ... ..
52454	2030	" Retainer ... ..
624c	2035	" " Set Screw ... ..
52215	—	<b>Thread Take-up</b> , complete, Nos. 11204, 52025 and 52217 ... ..
52216	2373	<b>Thread Take-up Crank</b> ... ..
52217	—	" " " 52216 with 775c and 52206 ... ..
1037a1	2035	" " " Position Screw ... ..
1036a1	2035	" " " Set Screw ... ..

No.	Plate	
52195	2040	<b>Arm Shaft</b> (horizontal) Flanged Bushing (front) ... ..
52196	—	" " ( " ) " " ( " ) 52195 with 52193 and 52194
52193	2040	" " ( " ) " " ( " ) Oil Pad (braided cotton)
52194	2064	" " ( " ) " " ( " ) Oil Pad (felt)
435c	1324	" " ( " ) " " ( " ) Set Screw ...
68350	2039	" " ( " ) Front Bearing Oil Cup (spring lid) ...
144d	1324	" " ( " ) Screw ... ..
127058	2028	" " (upright) ... ..
127073	2039	" " ( " ) Bevel Gear (lower) with two 1259c ...
1259c	2035	" " ( " ) " " ( " ) Set Screw ... ..
127074	2039	" " ( " ) " " (upper) with two 1259c ...
1259c	2035	" " ( " ) " " ( " ) Set Screw ... ..
52492	2039	" " ( " ) Bushing (lower) ... ..
432c	1324	" " ( " ) " ( " ) Set Screw ... ..
52493	2039	" " ( " ) " (upper) ... ..
435c	1324	" " ( " ) " ( " ) Set Screw ... ..
127146	2066	" Side Cap ... ..
219d	1324	" " " Screw ... ..
127079	2028	" " Cover ... ..
50053d	2035	" " " Thumb Screw ... ..
52239	2064	" Spool Pin and Thread Eyelet ... ..
8879	1316	" " " Washer (cloth) ... ..
127192	2064	<b>Arm Top Cover</b> ... ..
127493	2064	" " " 127192 with 52183, 52239, 127187 and 127255
52183	2064	" " " Oil Tube with 52184 ... ..
52184	2064	" " " " " Packing (cotton wick) ... ..
127187	2040	" " " " " (bent) with 42367 ... ..
42367	2064	" " " " " Packing (braided cotton)
127255	2378	" " " Positioning Disc ... ..
158j	1324	" " " Screw ... ..
150459	2064	" " " Tension Bracket with 460c ... ..
52183	2064	" " " " " Oil Tube with 52184 ... ..
52184	2064	" " " " " " " Packing (cotton wick)
127187	2040	" " " " " " " (bent) with 42367
42367	2064	" " " " " " " Packing (braided cotton)
158j	1324	" " " " " Screw ... ..
52239	2064	" " " " " Spool Pin ... ..
8879	1316	" " " " " " " Washer (cloth) ...
2455	1688	" " " " " Disc ... ..

No.	Plate	
41593	1316	<b>Arm Top Cover Tension Spring</b> ... ..
41594	1316	" " " " Stud ... ..
460c	1324	" " " " " Set Screw ... ..
41595	1316	" " " " " Thread Guide ... ..
150460	2064	<b>Arm Top Cover Tension Bracket</b> , complete, Nos. 41593 to 41595, 52183, 52239, 127187, 127255, 150459 and two 2455

NOTE.—No. ~~150460~~ is supplied with this machine unless No. ~~127193~~ is specified on order. ~~150460~~

<del>14283</del> 52187	2065	<b>Balance Wheel</b> (power, disc) 2 $\frac{3}{16}$ " pulley, with two 448c ...
<del>52081</del>	"	" " (stand, heavy rim) 2 $\frac{11}{16}$ " pulley, with two 448c
<del>52063</del>	2029	" " Oil Cover ... ..
<del>246d</del>	1324	" " " " Screw ... ..
<del>448c</del>	1324	" " " Set Screw ... ..

NOTE.—No. ~~52487~~ is supplied with this machine unless otherwise specified on order.

*52383	—	<b>Bed</b> ... ..
--------	---	-------------------

NOTE.—Due to the accuracy required for gear alignment, Bed cannot be supplied separately and can only be sent out as a unit, Arm and Bed assembled.

12431	—	<b>Bed Slide</b> ... ..
12432	2028	" " complete, Nos. 4307, 12431 and two 725c ...
4307	2028	" " Spring ... ..
725c	1324	" " " Screw ... ..

52051	—	<b>Face Plate</b> ... ..
176d	559	" " Screw ... ..
52053	2030	" " Thread Guard (lower) ... ..
226d	1324	" " " " ( " ) Screw ... ..
52170	—	" " " " (upper) ... ..
226d	1324	" " " " ( " ) Screw ... ..
50190d	2035	" " " Thumb Screw ... ..
52052	2028	<b>Face Plate</b> , complete, Nos. 52051, 52053, 52170 and two 226d ...

52452	2028	<b>Feed Bar</b> ... ..
313c	1324	" " Screw Centre (2) ... ..
1519c	2034	" " " " Nut (2) ... ..
52165	2066	" Connecting Link ... ..
375c	1324	" " " Hinge Screw ... ..
1518c	2034	" " " " " Nut ... ..
52073	2032	" " " " Stud ... ..
50083c	2035	" " " " " Set Screw ... ..

12436	7699	<b>Feed Dog</b> ... ..
50117c	2035	" " Screw (2) ... ..

No.	Plate	
127202	—	<b>Feed and Feed Lifting Eccentric</b> with 448c, 1299c, 52210 and 52211
127225	—	" " " " " 127202 with 127152
52210	1503	" " " " " " Lubricating Pad (wood, long)
52211	1503	" " " " " " " " ( " " short)
1299c	2040	" " " " " " Position Screw
448c	1324	" " " " " " Set Screw
127152	2066	" " " " " " Sleeve
20284	2029	<b>Feed Forked Connection</b>
52393	—	" " " " 20284 with 375c, 1518c and 52165
375c	1324	" " " " " Hinge Screw
1518c	2034	" " " " " " Nut
52384	2029	<b>Feed Lifting Rock Shaft</b>
127156	2065	" " " " " Connecting Rod with 127157 and two 966e
*127157	—	" " " " " " " Cap
966e	2035	" " " " " " " " Screw
375c	1324	" " " " " " " Hinge Screw
1518c	2034	" " " " " " " " " Nut
12373	2032	" " " " " " Crank with 157c and 1813
157c	1324	" " " " " " " Clamping Screw
1813	2034	" " " " " " " Roller and Stud
50191c	2034	" " " " " " " Screw Centre (2)
1513j	1317	" " " " " " " Nut (2)
52385	—	<b>Feed Lifting Rock Shaft, complete, Nos. 12376 and 52384</b>
52074	2033	<b>Feed Regulator</b> with 50083c
52118	—	" " " 52074 with 52073
52093	—	" " " 52118 with 818d
1128c	2035	" " " Hinge Screw
818d	2035	" " " Thumb Screw
52386	2029	<b>Feed Rock Shaft</b>
29633	2032	" " " " Crank with 157c
157c	1324	" " " " " Clamping Screw
50191c	2034	" " " " " Screw Centre (2)
1513j	1317	" " " " " " Nut (2)
142033	—	<b>Machine Pulley (disc) "V" belt groove (outside diam. of belt groove 2.9"), with two 435al</b>
52081	—	<b>Machine Pulley (stand, heavy rim), 2 1/8" pulley, with two 448c</b>
52063	2029	<b>Machine Pulley Oil Cover</b>
210d	1324	" " " " " Screw
448c	1324	" " " " " Set Screw for 52081
435al	1324	" " " " " " 142033

No.	Plate	
127088	2040	<b>Needle Bar</b> (hollow)
127131	—	" " 127088 with 229d, 127045 and 127016
127230	2373	" " Bushing (lower)
1133c	2035	" " " ( " ) Set Screw
52014	2039	" " " " (upper)
1133c	2035	" " " " ( " ) Set Screw
52205	2066	" " Connecting Link with 52207
52206	—	" " " " 52205 with 24041
775c	2035	" " " " " Cap Screw
52207	—	" " " " " Lubricating Pad (wood)
24041	2066	" " " " " Stud with 207q
207q	1688	" " " " " Clamping Screw
127253	2373	" " Crank with 1036al, 1037al, and 1065al
1065al	2035	" " " " " Position Screw
127045	2033	" " Thread Guard
229d	2035	" " " " " Screw
127016	2033	" " Clamp with 51460f
51460f	2378	" " " " " Screw
*52201	2064	<b>Oil Absorbent Wick</b>
52202	2064	" " " 52201, with 52203, for lower cavity in head of arm
*52203	2010	" " " " Wire
127191	—	<b>Oil Tube, with 52184</b>
127091	2010	" " " Bracket
127092	—	" " " 127091, with 127191, for oiling 52165
52184	2064	" " " Packing (cotton wick)
12391	2028	<b>Presser Bar</b> (hollow)
52338	1316	" " " Guide Bracket with 223c and 453c
453c	1316	" " " " " Set Screw
52016	1316	" " " Lifter
689c	1316	" " " " " Screw
1520f	1317	" " " " " Nut
12327	1316	" " " Lifting and Releasing Lever Bracket
127108	2029	" " " Spring
11170	1316	" " " " " Washer
688j	1324	<b>Pressure Regulating Thumb Screw</b>
51928	2375	<b>Roller</b> (ball-bearing) 3/8" diam., 3/16" face, coarse, complete, Nos. 1528d, 201699f, 350104f and twenty-eight 206417, for 127271
51903	2375	<b>Roller</b> (ball-bearing), 7/8" diam., 3/16" face, fine, complete, Nos. 1528d, 201699f, 350104f and twenty-eight 206417, for 62867
51899	2375	<b>Roller</b> (ball-bearing), 5/8" diam., 3/16" face, fine, complete, Nos. 1528d, 201699f, 350104f and twenty-eight 206417, for 62863

No.	Plate	
127273	—	<b>Roller Arm</b> for 127271 ... ..
62897	—	" " " 62867 ... ..
62856	—	" " " 62863 ... ..
440f	2378	" " Adjusting Screw ... ..
1547j	2378	" " " " Nut ... ..
80297	2375	" " Bracket ... ..
316f	1324	" " " Screw Centre ... ..
1547j	2378	" " " " Nut ... ..
2205	2378	" " Lock Spring ... ..
176d	559	" " " " Screw ... ..
1549j	2378	" " " " Nut ... ..
206417	—	" Ball, $\frac{1}{16}$ " diam. ... ..
201699f	2378	" Retaining Nut ... ..
350104f	2378	" Screw ... ..
1528d	2378	" Nut ... ..
127271	2375	<b>Roller Presser</b> (ball-bearing), $\frac{3}{8}$ " diam., $\frac{3}{16}$ " face, coarse, complete. Nos. 176d, 440f, 1549j, 2205, 51928, 80297, 127273, two 316f and three 1547j ... ..
62867	2375	<b>Roller Presser</b> (ball-bearing), $\frac{7}{8}$ " diam., $\frac{3}{16}$ " face, fine, complete. Nos. 176d, 440f, 1549j, 2205, 51903, 62897, 80297, two 316f and three 1547j ... ..
62863	2375	<b>Roller Presser</b> (ball-bearing), $\frac{7}{8}$ " diam., $\frac{3}{16}$ " face, fine, complete. Nos. 176d, 440f, 1549j, 2205, 51899, 62856, 80297, two 316f and three 1547j ... ..
176d	559	<b>Roller Presser Screw</b> ... ..
127095	2039	<b>Rotating Hook</b> with three 1253c ... ..
127096	—	" " 127095 with 127102 and four 1053e ... ..
127239	—	" " 127096 " 40274, 127242 and three 1367d ... ..
127097	—	" " 127096 " 40274 and three 1367d (for agents only) ... ..
127240	—	" " 127239 " 52237 ... ..
10264	2032	" Bobbin ... ..
52235	—	" " Case ... ..
52236	—	" " " 52235 with 591f, 1380d and 40394 ... ..
40393	—	" " " Hinge, Nos. 2974, 40392 and 125320 ... ..
127242	—	" " " Holder ... ..
52018	2032	" " " Position Bracket ... ..
704j	1324	" " " " Screw ... ..
40392	2032	" " " Latch ... ..
125320	2066	" " " Lever ... ..
2974	2032	" " " Fulcrum Pin ... ..
2975	2032	" " " Spring ... ..
144828	—	Rotating Hook with three 1253c Stop Screw ... ..
144829	—	Rotating Hook 144828 with 270083 and four 1053e Screw ... ..
144830	—	Rotating Hook 144829 with 40274, 143346 and three 1367e ... ..
144832	—	Rotating Hook 144830 with 52237 ... ..
144831	—	Rotating Hook 144829 with 40274 and three 1367e (for agents only) ... ..

1053  
144828  
144829  
144830  
144831  
144832

No.	Plate	
40394	2032	<b>Rotating Hook</b> Bobbin Case Tension Spring ... ..
1380d	2035	" " " " " " Screw ... ..
52237	2032	" " " " complete, Nos. 592c, 2975, 40393 and 52236 ... ..
127244	—	" " " " 52237 with 127242 (for agents only) ... ..
40274	2032	" " Section ... ..
1367d	2035	" " " Screw ... ..
1253c	2035	" " Set Screw ... ..
127059	2065	" " Shaft ... ..
127073	2039	" " " Bevel Gear with two 1259c ... ..
127007	2029	" " " " Case (two pieces) with 121e and 50234d ... ..
50234d	2035	" " " " Plug Screw ... ..
121e	1324	" " " " Screw ... ..
1259c	2035	" " " " Set Screw ... ..
127004	2039	" " " Bushing (back) ... ..
127043	—	" " " " ( " ) 127004 with 52045 ... ..
52045	2032	" " " " ( " ) Packing (cotton) ... ..
1143c	2035	" " " " ( " ) Set Screw ... ..
127005	2039	" " " " (front) ... ..
127044	—	" " " " ( " ) 127005 with 52045 ... ..
142008	2373	" " " " ( " ) Oil Cup ... ..
52045	2032	" " " " ( " ) Packing (cotton) ... ..
1148c	2035	" " " " ( " ) Set Screw ... ..
127102	2039	" " Thread Guard ... ..
1053e	2035	" " " " Screw ... ..
52337	1316	<b>Slack Thread Regulator</b> ... ..
223c	1316	" " " Set Screw ... ..
52046	1815	<b>Spool Holder Base</b> ... ..
389d	2035	" " " Screw ... ..
204296	1815	" " " Wire ... ..
200079h	2034	" " " Hinge Screw ... ..
52047	1815	<b>Spool Holder</b> , complete, Nos. 52046, 200079h and 204296 ... ..
2102	2032	<b>Tension Disc</b> ... ..
1560c	2034	" Regulating Thumb Nut ... ..
32572	2032	" Releasing Disc ... ..
43944	1316	" " Lever ... ..
12398	1316	" " " Hinge Pin ... ..
12329	1316	" " " Spring ... ..
32571	2032	" " Pin ... ..
2103	2032	" Spring ... ..
*50304c	2034	" Stud ... ..
52098	—	" " 50304c with 1560c ... ..
50305c	2035	" " Set Screw ... ..

270083

No.	Plate	
52397	—	<b>Tension</b> , complete, Nos. 2103, 32572, 32574, 52083, 52098, 52394 and two 2102 ... ..
52027	2032	<b>Thread Guard</b> (side of arm) ... ..
52454	2030	" Retainer ... ..
624c	2035	" " Set Screw ... ..
52215	—	<b>Thread Take-up</b> , complete, Nos. 11201, 52025 and 52217 ... ..
52216	2373	<b>Thread Take-up Crank</b> ... ..
52217	—	" " " 52216 with 775c and 52206 ... ..
1037al	2035	" " " Position Screw ... ..
1036al	2035	" " " Set Screw ... ..
52022	1503	<b>Thread Take-up Lever</b> with 52130 ... ..
52023	2039	" " " Hinge Pin ... ..
52024	2039	" " " Link ... ..
11204	2033	" " " Hinge Pin ... ..
435c	1324	" " " " " Set Screw ... ..
52130	—	" " " Thread Eyelet Bushing ... ..
52025	—	<b>Thread Take-up Lever</b> , complete, Nos. 52022 to 52024 ... ..
52394	2039	<b>Thread Take-up Spring</b> ... ..
52083	2032	" " " Regulator with 50305c ... ..
448c	1324	" " " " " Set Screw ... ..
2444	—	<b>Throat Plate</b> , large oblong needle hole, for 12436 ... ..
24443	7699	" " small " " " " 12436 ... ..
691f	1324	" " " Screw (2) ... ..

NOTE: Throat Plate No. 2444 is sent with this machine unless otherwise specified on order.

139622 — **Drip Pan** with four  $\frac{3}{4}$ " wire nails ... ..

## PARTS COMPLETE

FOR

## No. 96K43 MACHINE

For Stitching Top Facings to Shoe Lining, also for Side and Back Stays. Maximum Stitch 7 to the inch. Drop Feed. Roller Presser. Knee Lifter.

No.	Plate	
*127330	—	<b>Arm</b> with two 56015 ... ..

NOTE: Due to the accuracy required for gear alignment, Arm cannot be supplied separately and can only be sent out as a unit, Arm and Bed assembled.

16532	2032	<b>Arm Dowel Pin</b> (2) ... ..
52182	2066	" Oil Tube, with 52184, for oiling 52205 ... ..
52183	2064	" " " " 52184, " " 52024 ... ..
52180	2066	" " " (long) with 52184, for oiling 52022 ... ..
52185	2066	" " " (short) " 12367, " " 52022 ... ..
142087	—	" " " with Hole Cover and Holder ... ..
142069	2545	" " " 142087, with 52150, for oiling 127072 and 127074 ... ..
<del>56015</del>	2033	" " " for oiling 127058 (2) ... ..
52150	2039	" " " Packing (braided cotton) for 142069 ... ..
42367	2064	" " " " ( " " ) " 52185 ... ..
52184	2064	" " " " (cotton wick) for 52180, 52182, 52183, and 127191 ... ..
116e	1324	" Screw (back) (2) ... ..
854c	2035	" " (front) (2) ... ..
127017	1815	<b>Arm Shaft</b> (horizontal) ... ..
88615	—	" " ( " ) 127017 with 127253 ... ..
127072	2039	" " ( " ) Bevel Gear with two 1036c ... ..
127070	2029	" " ( " ) " " Case (two pieces) with 121e ... ..
121e	1324	" " ( " ) " " " Screw ... ..
1036c	2035	" " ( " ) " " Set Screw ... ..
52191	2040	" " ( " ) Flanged Bushing (back) ... ..
52192	—	" " ( " ) " " ( " ) 52194, with 52193 and 52194 ... ..
52193	2040	" " ( " ) " " ( " ) Oil Pad (braided cotton) ... ..
52194	2064	" " ( " ) " " ( " ) Oil Pad (felt) ... ..
446c	1324	" " ( " ) " " ( " ) Set Screw ... ..
52195	2040	" " ( " ) " " (front) ... ..
52196	—	" " ( " ) 52195 with 52193 and 52194 ... ..



No.	Plate				
52193	2040	<b>Arm Shaft</b> (horizontal) Flanged Bushing (front) Oil Pad (braided cotton)			
52194	2064	" " ( " ) " " ( " ) Oil Pad (left)			
435c	1324	" " ( " ) " " ( " ) Set Screw ...			
68350	2039	" " ( " ) Front Bearing Oil Cup (spring lid) ...			
144d	1324	" " ( " ) Screw ...			
127058	2028	" " (upright) ...			
127073	2039	" " ( " ) Bevel Gear (lower) with two 1259c ...			
1259c	2035	" " ( " ) " " ( " ) Set Screw ...			
127074	2039	" " ( " ) " " (upper) with two 1259c ...			
1259c	2035	" " ( " ) " " ( " ) Set Screw ...			
52492	2039	" " ( " ) Bushing (lower) ...			
432c	1324	" " ( " ) " " ( " ) Set Screw ...			
52493	2039	" " ( " ) " " (upper) ...			
435c	1324	" " ( " ) " " ( " ) Set Screw ...			
127116	2066	" Side Cap ...			
219d	1324	" " " Screw ...			
127079	2028	" " Cover ...			
50053d	2035	" " " Thumb Screw ...			
52239	2064	" Spool Pin and Thread Eyelet ...			
8879	1316	" " " Washer (cloth) ...			
127192	2064	<b>Arm Top Cover</b> ...			
127193	2064	" " " 127192 with 52183, 52239, 127187 and 127255			
52183	2064	" " " Oil Tube with 52184 ...			
52184	2064	" " " " " Packing (cotton wick) ...			
127187	2040	" " " " " (bent) with 42367 ...			
42367	2064	" " " " " Packing (braided cotton) ...			
127255	2378	" " " Positioning Disc ...			
158j	1324	" " " Screw ...			
150459	2064	" " " Tension Bracket with 460c ...			
52183	2064	" " " " " Oil Tube with 52184 ...			
52184	2064	" " " " " " " Packing (cotton wick)			
127187	2040	" " " " " (bent) with 42367 ...			
42367	2064	" " " " " Packing (braided cotton)			
158j	1324	" " " " " Screw ...			
52239	2064	" " " " " Spool Pin ...			
8879	1316	" " " " " Washer (cloth) ...			
2455	1688	" " " " " Disc ...			
41593	1316	" " " " " Spring ...			
41594	1316	" " " " " Stud ...			
460c	1324	" " " " " Set Screw ...			
41595	1316	" " " " " Thread Guide ...			

No.	Plate				
150160	2064	<b>Arm Top Cover Tension Bracket</b> , complete, Nos. 41593 to 41595, 52183, 52239, 127187, 127255, 150459 and two 2455			
NOTE: No. <del>150160</del> is supplied with this machine unless No. <del>127193</del> is specified on order. <del>150460</del>					
142033					
52487	2065	<b>Balance Wheel</b> (power, disc) $2\frac{3}{16}$ " pulley, with two 448c ...			
52081		" " (stand, heavy rim) $2\frac{3}{16}$ " pulley, with two 448c ...			
52063	2029	" " Oil Cover ...			
240d	1324	" " " " Screw ...			
448c	1324	" " " " Set Screw ...			
NOTE: No. <del>52487</del> is supplied with this machine unless otherwise specified on order.					
*52383		<b>Bed</b> ...			
NOTE: Due to the accuracy required for gear alignment, Bed cannot be supplied separately and can only be sent out as a unit, Arm and Bed assembled.					
52417		<b>Bed Slide</b> ...			
52418	2030	" " complete, Nos. 52417, 52464 and two 665c ...			
52464	2033	" " Spring ...			
665c	2035	" " " " Screw ...			
120063	7703	<b>Edge Guide</b> ...			
50190b	2035	" " Thumb Screw ...			
52051		<b>Face Plate</b> ...			
176d	559	" " Screw ...			
52053	2030	" " Thread Guard (lower) ...			
226d	1324	" " " " ( " ) Screw ...			
52170		" " " " (upper) ...			
226d	1324	" " " " ( " ) Screw ...			
50190d	2035	" " Thumb Screw ...			
52052	2028	<b>Face Plate</b> , complete, Nos. 52051, 52053, 52170 and two 226d ...			
52452	2028	<b>Feed Bar</b> ...			
313c	1324	" " Screw Centre (2) ...			
1519c	2034	" " " " Nut (2) ...			
52165	2066	" Connecting Link ...			
375c	1324	" " " Hinge Screw ...			
1518c	2034	" " " " Nut ...			
52073	2032	" " " " Stud ...			
50083c	2035	" " " " Set Screw ...			
12436	7699	<b>Feed Dog</b> ...			
50117c	2035	" " Screw (2) ...			
127202		<b>Feed and Feed Lifting Eccentric</b> with 448c, 1299c, 52210 and 52211			
127225		" " " " " 127202 with 127152 ...			
52210	1503	" " " " " Lubricating Pad (wood, long)			
52211	1503	" " " " " " " ( " short)			

No.	Plate				
1299c	2040	<b>Feed and Feed Lifting Eccentric</b>	Position Screw	...	...
448c	1324	" " " "	Set Screw	...	...
127152	2066	" " " "	Sleeve	...	...
20284	2029	<b>Feed Forked Connection</b>	...	...	...
52393	—	" " " "	20284 with 375c, 1518c and 52165	...	...
375c	1324	" " " "	Hinge Screw	...	...
1518c	2034	" " " "	" " Nut	...	...
52384	2029	<b>Feed Lifting Rock Shaft</b>	...	...	...
127156	2065	" " " "	Connecting Rod with 127157 and two 966e	...	...
*127157	—	" " " "	" " Cap	...	...
966e	2035	" " " "	" " Screw	...	...
375c	1324	" " " "	" " Hinge Screw	...	...
1518c	2034	" " " "	" " " Nut	...	...
12376	2032	" " " "	Crank with 157c and 1813	...	...
157c	1324	" " " "	" Clamping Screw	...	...
1813	2034	" " " "	" Roller and Stud	...	...
50191c	2034	" " " "	" Screw Centre (2)	...	...
1513j	1317	" " " "	" " Nut (2)	...	...
52385	—	<b>Feed Lifting Rock Shaft</b> , complete, Nos. 12376 and 52384	...	...	...
52614	2033	<b>Feed Regulator</b> with 50083c	...	...	...
52118	—	" " 52074 with 52073	...	...	...
52093	—	" " 52118 with 818d	...	...	...
1128c	2035	" " Hinge Screw	...	...	...
818d	2035	" " Thumb Screw	...	...	...
52386	2029	<b>Feed Rock Shaft</b>	...	...	...
29633	2032	" " " "	Crank with 157c	...	...
157c	1324	" " " "	" Clamping Screw	...	...
50191c	2034	" " " "	" Screw Centre (2)	...	...
1513j	1317	" " " "	" " Nut (2)	...	...
52387	—	<b>Feed Rock Shaft</b> , complete, Nos. 29633 and 52386	...	...	...
127088	2040	<b>Needle Bar</b> (hollow)	...	...	...
127132	—	" " 127088 with 229d, 52307 and 52415	...	...	...
127230	2373	" " " "	...	...	...
142033	—	Machine Pulley (disc) "V" belt groove (outside diam. of belt groove 2-9"), with two 435al	...	...	...
52081	—	Machine Pulley (stand, heavy rim), 2 $\frac{11}{16}$ " pulley, with two 448c	...	...	...
52063	2029	<b>Machine Pulley Oil Cover</b>	...	...	...
210d	1324	" " " "	Screw	...	...
448c	1324	" " " "	Set Screw for 52081	...	...
435al	1324	" " " "	" 142033	...	...

Note—No. 142033 is supplied with machine unless otherwise specified on order

No.	Plate				
24041	2066	<b>Needle Bar</b> Connecting Stud with 207a <sup>f</sup>	...	...	...
207c <sup>f</sup>	1688	" " " "	Clamping Screw	...	...
127253	2373	" " " "	Crank with 1036al, 1037al, and 1065al	...	...
1065al	2035	" " " "	" Position Screw	...	...
52415	2033	" " " "	" Thread Guard	...	...
229d	2035	" " " "	" " Screw	...	...
52307	2039	" " " "	Clamp with 51460f	...	...
51460f	2378	" " " "	" Screw	...	...
*52201	2064	<b>Oil Absorbent Wick</b>	...	...	...
52202	2064	" " " "	52201, with 52203, for lower cavity in head of arm	...	...
*52203	2040	" " " "	Wire	...	...
127191	—	<b>Oil Tube</b> , with 52184	...	...	...
127091	2040	" " " "	Bracket	...	...
127092	—	" " " "	127091, with 127191, for oiling 52165	...	...
52184	2064	" " " "	Packing (cotton wick)	...	...
12391	2028	<b>Presser Bar</b> (hollow)	...	...	...
52338	1316	" " " "	Guide Bracket with 223c and 453c	...	...
453c	1316	" " " "	" Set Screw	...	...
52016	1316	" " " "	Lifter	...	...
689c	1316	" " " "	" Screw	...	...
1520r	1317	" " " "	" " Nut	...	...
12327	1316	" " " "	Lifting and Releasing Lever Bracket	...	...
127108	2029	" " " "	Spring	...	...
11170	1316	" " " "	" Washer	...	...
688j	1324	<b>Pressure Regulating Thumb Screw</b>	...	...	...
51928	2375	<b>Roller</b> (ball-bearing), $\frac{3}{8}$ " diam., $\frac{3}{16}$ " face, coarse, complete, Nos. 1528d, 201699f, 350104f and twenty eight 206417, for 127271	...	...	...
51903	2375	<b>Roller</b> (ball-bearing), $\frac{7}{8}$ " diam., $\frac{3}{16}$ " face, fine, complete, Nos. 1528d, 201699f, 350104f and twenty eight 206417, for 62867	...	...	...
51927	2375	<b>Roller</b> (ball-bearing), $1\frac{1}{4}$ " diam., $\frac{11}{16}$ " face, coarse, complete, Nos. 1528d, 1766c, 50553c and twenty-four 16232, for 127272	...	...	...
127273	—	<b>Roller Arm</b> for 127271	...	...	...
62897	—	" " " "	62867	...	...
127274	—	" " " "	127272	...	...
440f	2378	" " " "	Adjusting Screw	...	...
1547j	2378	" " " "	" " Nut	...	...
80297	2375	" " " "	Bracket	...	...
316f	1324	" " " "	" Screw Centre	...	...
1547j	2378	" " " "	" " Nut	...	...
2205	2378	" " " "	Lock Spring	...	...
176d	559	" " " "	" Screw	...	...
1549j	2378	" " " "	" " Nut	...	...

No.	Plate	
206417		<b>Roller Ball</b> , $\frac{1}{16}$ " diam., for 51903 and 51928
16232		" " $\frac{3}{32}$ " diam., for 51927
201699f	2378	" " Retaining Nut for 51903 and 51928
1766c	2378	" " " " " 51927
350104f	2378	" Screw for 51903 and 51928
50553c	2035	" " " 51927
1528d	2378	" " Nut
127271	2375	<b>Roller Presser</b> (ball-bearing), $\frac{5}{8}$ " diam., $\frac{3}{16}$ " face, coarse, complete, Nos. 176d, 440f, 1549j, 2205, 51928, 80297, 127273, two 316f and three 1547j
62867	2375	<b>Roller Presser</b> (ball-bearing), $\frac{7}{8}$ " diam., $\frac{3}{16}$ " face, fine, complete, Nos. 176d, 440f, 1549j, 2205, 51903, 62897, 80297, two 316f and three 1547j
127272	2375	<b>Roller Presser</b> (ball-bearing), $1\frac{1}{4}$ " diam., $\frac{1}{4}$ " face, coarse, complete, Nos. 176d, 440f, 1549j, 2205, 51927, 80297, 127274, two 316f and three 1547j
176d	559	<b>Roller Presser Screw</b>
127095	2039	<b>Rotating Hook</b> with three 1253c
127096	2039	" " 127095 with 127102 and four 1053c
127097	2039	" " 127096 " 40274, 127242 and three 1367d
127097	2039	" " 127096 " 40274, and three 1367d (for agents only)
127240	2032	" " 127239 with 52237
40264	2032	" " Bobbin
52235	2032	" " Case
52236	2032	" " " 52235 with 5911, 1380d and 40394
40393	2032	" " " " Hinge, Nos. 2974, 40392 and 125320
14334k	2032	" " " " Holder
127242	2032	" " " " " Position Bracket
704j	1324	" " " " " " Screw
40392	2032	" " " " " Latch
125320	2066	" " " " " Lever
2974	2032	" " " " " Fulcrum Pin
2975	2032	" " " " " Spring
592e	1324	" " " " " Stop Screw
591f	1324	" " " " " Tension Regulating Screw
40394	2032	" " " " " Spring
1380d	2035	" " " " " Screw
52237	2032	" " " " " complete, Nos. 592e, 2975, 40393 and 14334k and 52236
14334s	2032	" " " " " 52237 with 127242 (for agents only)
144828	—	Rotating Hook with three 1253c
144829	—	Rotating Hook 144828 with 270083 and four 1053c
144830	—	Rotating Hook 144829 with 40274, 143346 and three 1367e
144832	—	Rotating Hook 144830 with 52237
144831	—	Rotating Hook 144829 with 40274 and three 1367e (for agents only)

No.	Plate	
1253c	2035	<b>Rotating Hook</b> Set Screw
127059	2065	" " Shaft
127073	2039	" " " Bevel Gear with two 1259c
127007	2029	" " " " " Case (two pieces) with 121e and 50231d
50231d	2035	" " " " " Plug Screw
121e	1324	" " " " " Screw
1259c	2035	" " " " " Set Screw
127004	2039	" " " " Bushing (back)
127043	2032	" " " " " ( ) 127004 with 52045
52045	2032	" " " " " ( ) Packing (cotton)
1143c	2035	" " " " " ( ) Set Screw
127005	2039	" " " " " (front)
127044	2032	" " " " " ( ) 127005 with 52045
112008	2373	" " " " " ( ) Oil Cup
52045	2032	" " " " " ( ) Packing (cotton)
1148c	2035	" " " " " ( ) Set Screw
270083 127102	2039	" " " " Thread Guard
1053c	2035	" " " " " Screw
52337	1316	<b>Slack Thread Regulator</b>
223c	1316	" " " " Set Screw
52046	1815	<b>Spool Holder Base</b>
389d	2035	" " " " Screw
204296	1815	" " " " Wire
200079h	2034	" " " " " Hinge Screw
52047	1815	<b>Spool Holder</b> , complete, Nos. 52046, 200079h and 204296
120067	7704	<b>Strip Guide</b>
120068	7704	" " (adjustable) with 291f
120069	7704	" " ( " ) Bar
120070	7704	" " ( " ) " Plate
50169d	7704	" " ( " ) " " Screw
50169d	7704	" " ( " ) " " Screw
291f	7704	" " ( " ) Thumb Screw
120071	7704	<b>Strip Guide</b> (adjustable), complete, Nos. 120067 to 120070 and six 50169d
1423d	7704	" " " " Screw
2102	2032	<b>Tension Disc</b>
1560c	2034	" " Regulating Thumb Nut
32572	2032	" " Releasing Disc
43944	1316	" " " " Lever
12398	1316	" " " " " Hinge Pin
12329	1316	" " " " " Spring

No.	Plate						
32574	2032	<b>Tension Releasing Pin</b>	...	...	...	...	...
2103	2032	" Spring	...	...	...	...	...
*50304c	2034	" Stud	...	...	...	...	...
52098	---	" " 50304c with 1560c	...	...	...	...	...
50305c	2035	" " Set Screw	...	...	...	...	...
52397	---	<b>Tension, complete, Nos. 2103, 32572, 32574, 52083, 52098, 52394 and two 2102</b>	...	...	...	...	...
52027	2032	<b>Thread Guard (side of arm)</b>	...	...	...	...	...
52454	2030	" Retainer	...	...	...	...	...
624c	2035	" " Set Screw	...	...	...	...	...
52215	---	<b>Thread Take-up, complete, Nos. 11204, 52205 and 52217</b>	...	...	...	...	...
52216	2373	<b>Thread Take-up Crank</b>	...	...	...	...	...
52217	---	" " " 52216 with 775c and 52206	...	...	...	...	...
1037al	2035	" " " Position Screw	...	...	...	...	...
1036al	2035	" " " Set Screw	...	...	...	...	...
52022	1503	<b>Thread Take-up Lever with 52130</b>	...	...	...	...	...
52023	2039	" " " Hinge Pin	...	...	...	...	...
52024	2039	" " " Link	...	...	...	...	...
11204	2033	" " " Hinge Pin	...	...	...	...	...
435c	1324	" " " " " " Set Screw	...	...	...	...	...
52130	---	" " " Thread Eyelet Bushing	...	...	...	...	...
52025	---	<b>Thread Take-up Lever, complete, Nos. 52022 to 52024</b>	...	...	...	...	...
52394	2039	<b>Thread Take-up Spring</b>	...	...	...	...	...
52083	2032	" " " Regulator with 50305c	...	...	...	...	...
448c	1324	" " " " " " Set Screw	...	...	...	...	...
12438	7699	<b>Throat Plate, large oblong needle hole, for 12136</b>	...	...	...	...	...
20192	---	" " " small " " " " 12136	...	...	...	...	...
691f	1324	" " " Screw (2)	...	...	...	...	...

NOTE: Throat Plate No. 12438 is sent with this machine unless otherwise specified on order.

*15404	---	<b>Trade Mark</b>	...	...	...	...	...
15405	---	" " Rivet	...	...	...	...	...
139622	---	<b>Drip Pan with four 3/4" wire nails</b>	...	...	...	...	...

## PARTS COMPLETE FOR No. 96K44 MACHINE

For Overalls, Heavy Overcoats, Khaki and other heavy materials. Maximum Stitch 5 to the inch. Reversible Feed. Lift of Presser Foot  $\frac{5}{16}$ ". Knee Lifter.

No.	Plate						
*127329	---	<b>Arm with two 56015</b>	...	...	...	...	...
16532	2032	<b>Arm Dowel Pin (2)</b>	...	...	...	...	...
52182	2066	" Oil Tube, with 52184, for oiling 52205	...	...	...	...	...
52183	2064	" " " " 52184, " " 52024	...	...	...	...	...
52180	2066	" " " (long), with 52184, for oiling 52022	...	...	...	...	...
52185	2066	" " " (short), " 42367, " " 52022	...	...	...	...	...
142087	---	" " " with Hole Cover and Holder	...	...	...	...	...
142069	2545	" " " 142087, with 52150, for oiling 127072 and 127974	...	...	...	...	...
<del>52015</del>	2033	" " " for oiling 127058 (2)	...	...	...	...	...
52150	2039	" " " Packing (braided cotton) for 142069	...	...	...	...	...
42367	2064	" " " " ( " " ) " 52185	...	...	...	...	...
52184	2064	" " " " (cotton wick) for 52180, 52182, 52183, and 127191	...	...	...	...	...
116e	1324	" Screw (back) (2)	...	...	...	...	...
854e	2035	" " (front) (2)	...	...	...	...	...
52382	2372	<b>Arm Shaft (horizontal)</b>	...	...	...	...	...
88618	---	" " ( " ) 52382 with 127222	...	...	...	...	...
127072	2039	" " ( " ) Bevel Gear with two 1036c	...	...	...	...	...
127070	2029	" " ( " ) " " Case (two pieces) with 121e	...	...	...	...	...
121e	1324	" " ( " ) " " " Screw	...	...	...	...	...
1036c	2035	" " ( " ) " " " Set Screw	...	...	...	...	...
52191	2040	" " ( " ) Flanged Bushing (back)	...	...	...	...	...
52192	---	" " ( " ) " " ( " ) 52191 with 52193 and 52194	...	...	...	...	...
52193	2040	" " ( " ) " " ( " ) Oil Pad (braided cotton)	...	...	...	...	...
52194	2064	" " ( " ) " " ( " ) Oil Pad (felt)	...	...	...	...	...
446c	1324	" " ( " ) " " ( " ) Set Screw	...	...	...	...	...
52195	2040	" " ( " ) " " (front)	...	...	...	...	...

No.	Plate	
52196	—	<b>Arm Shaft</b> (horizontal) Flanged Bushing (front) 52195 with 52193 and 52194
52193	2040	" " ( " ) " " ( " ) Oil Pad (braided cotton)
52194	2064	" " ( " ) " " ( " ) Oil Pad (left)
435c	1324	" " ( " ) " " ( " ) Set Screw ...
68350	2039	" " ( " ) Front Bearing Oil Cup (spring lid) ...
141d	1324	" " ( " ) Screw ...
127058	2028	" " (upright) ...
127073	2039	" " ( " ) Bevel Gear (lower) with two 1259e ...
1259e	2035	" " ( " ) " " ( " ) Set Screw ...
127074	2039	" " ( " ) " " (upper) with two 1259e ...
1259e	2035	" " ( " ) " " ( " ) Set Screw ...
52192	2039	" " ( " ) Bushing (lower) ...
432c	1324	" " ( " ) " " ( " ) Set Screw ...
52193	2039	" " ( " ) " " (upper) ...
435c	1324	" " ( " ) " " ( " ) Set Screw ...
127146	2066	" Side Cap ...
219d	1324	" " " Screw ...
127079	2028	" " Cover ...
50053d	2035	" " " Thumb Screw ...
52239	2064	" Spool Pin and Thread Eyelet ...
8879	1316	" " " Washer (cloth) ...
127192	2064	<b>Arm Top Cover</b> ...
127193	2064	" " " 127192 with 52183, 52239, 127187 and 127255
52183	2064	" " " Oil Tube with 52184 ...
52184	2064	" " " " " Packing (cotton wick) ...
127187	2040	" " " " " (bent) with 42367 ...
12367	2064	" " " " " Packing (braided cotton) ...
127255	2378	" " " Positioning Disc ...
158j	1324	" " " Screw ...
150159	2064	" " " Tension Bracket with 460c ...
52183	2064	" " " " " Oil Tube with 52184 ...
52184	2064	" " " " " " " Packing (cotton wick)
127187	2040	" " " " " " " (bent) with 42367
42367	2064	" " " " " " " Packing (braided cotton)
158j	1324	" " " " " Screw ...
52239	2064	" " " " " Spool Pin ...
8879	1316	" " " " " " " Washer (cloth) ...
2455	1688	" " " " " Disc ...
41593	1316	" " " " " Spring ...
41594	1316	" " " " " Stud ...
460c	1324	" " " " " Set Screw ...
41595	1316	" " " " " Thread Guide ...

No.	Plate	
150160	2064	<b>Arm Top Cover Tension Bracket</b> , complete, Nos. 41593 to 41595, 52183, 52239, 127187, 127255, 150159 and two 2455
NOTE. No. <del>150160</del> is supplied with this machine unless No. <del>127193</del> is specified on order. <span style="float: right;">150460</span>		
<del>142033</del> 52187	2065	<b>Balance Wheel</b> (power, disc) 2 $\frac{3}{16}$ " pulley, with two 418c ...
<del>52081</del>		" " (stand, heavy rim), 2 $\frac{1}{16}$ " pulley, with two 418c ...
<del>52083</del>	2029	" " Oil Cover ...
<del>2401</del>	1324	" " " " Screw ...
<del>448</del>	1324	" " Set Screw ...
NOTE. No. <del>52187</del> is supplied with this machine unless otherwise specified on order.		
*52383		<b>Bed</b> ...
NOTE. Due to the accuracy required for gear alignment, Bed cannot be supplied separately and can only be sent out as a unit, Arm and Bed assembled.		
12431		<b>Bed Slide</b> ...
12432	2028	" " complete, Nos. 4307, 12431 and two 725c ...
4307	2028	" " Spring ...
725c	1324	" " " Screw ...
52051		<b>Face Plate</b> ...
176d	559	" " Screw ...
52053	2030	" " Thread Guard (lower) ...
226d	1324	" " " " ( " ) Screw ...
52170		" " " " (upper) ...
226d	1324	" " " " ( " ) Screw ...
50190d	2035	" " Thumb Screw ...
52052	2028	<b>Face Plate</b> , complete, Nos. 52051, 52053, 52170 and two 226d ...
52452	2028	<b>Feed Bar</b> ...
313c	1324	" " Screw Centre (2) ...
1519e	2034	" " " " Nut (2) ...
52165	2066	" Connecting Link ...
375e	1324	" " " Hinge Screw ...
1518e	2034	" " " " " Nut ...
52073	2032	" " " " Stud ...
50083c	2035	" " " " Set Screw ...
121416	2376	<b>Feed Dog</b> (spiked teeth) ...
50117c	2035	" " Screw (2) ...
127324	2373	<b>Feed and Feed Lifting Eccentric</b> with 52210, 52211 and two 418al
127325		" " " " " 127324 with 127152 ...
52210	1503	" " " " " Lubricating Pad (wood, long)
52211	1503	" " " " " " " ( " short)
448al	1324	" " " " " Set Screw ...
127152	2066	" " " " " Sleeve ...

No.	Plate					
52407	2029	<b>Feed Forked Connection</b>	...	...	...	...
52451	---	" "	"	"	52407 with 375c, 1518c and 52165	...
375c	1324	" "	"	"	Hinge Screw	...
1518c	2034	" "	"	"	" " Nut	...
52384	2029	<b>Feed Lifting Rock Shaft</b>	...	...	...	...
127156	2065	" "	"	"	Connecting Rod with 127157 and two 966c	...
*127157	---	" "	"	"	" " Cap	...
966c	2035	" "	"	"	" " Screw	...
375c	1324	" "	"	"	" " Hinge Screw	...
1518c	2034	" "	"	"	" " " " Nut	...
52434	1502	" "	"	"	Crank with 157c and 1813	...
157c	1324	" "	"	"	" Clamping Screw	...
1813	2034	" "	"	"	" Roller and Stud	...
50191c	2034	" "	"	"	Screw Centre (2)	...
1513j	1317	" "	"	"	" " Nut (2)	...
52433	---	<b>Feed Lifting Rock Shaft, complete, Nos. 52384 and 52434</b>	...	...	...	...
50338e	2031	<b>Feed Regulating Screw Stud</b>	...	...	...	...
56032	1502	" "	"	"	Head with 56033	...
50193j	2035	" "	"	"	" Cap Screw	...
56033	1503	" "	"	"	" Stop Pin	...
56034	1502	" "	"	"	" Lock Pin	...
56035	1502	" "	"	"	" " Spring	...
52408	1502	<b>Feed Regulator with 50083c</b>	...	...	...	...
52411	---	" "	"	"	52408 with 52073	...
1128e	2035	" "	"	"	Hinge Screw	...
52409	1502	<b>Feed Reverse Lever with 158c and 51816</b>	...	...	...	...
50339d	2034	" "	"	"	Hinge Screw	...
158c	1324	" "	"	"	" Clamping Screw	...
52410	1502	" "	"	"	" Friction Washer	...
51816	2034	" "	"	"	" Roller and Stud	...
52386	2029	<b>Feed Rock Shaft</b>	...	...	...	...
29633	2032	" "	"	"	Crank with 157c	...
142033	---	Machine Pulley (disc "V" belt groove (outside diam. of belt groove 2-9"), with two 435al	...	...	...	...
52081	---	Machine Pulley (stand, heavy rim), 2 $\frac{11}{16}$ " pulley, with two 448c	...	...	...	386
52063	2029	Machine Pulley Oil Cover	...	...	...	...
210d	1324	" " " " Screw	...	...	...	...
448c	1324	" " Set Screw for 52081	...	...	...	...
435al	1324	" " " " " 142033	...	...	...	...

Note—No. 142033 is supplied with machine unless otherwise specified on order

No.	Plate					
127088	2040	<b>Needle Bar (hollow)</b>	...	...	...	...
127322	---	" "	"	"	127088 with 229d, 52307 and 127323	...
127305	2373	" "	"	"	Bushing (lower)	...
1133c	2035	" "	"	"	" ( " )	...
52448	1503	" "	"	"	" (upper)	...
1133c	2035	" "	"	"	" ( " ) Set Screw	...
52205	2066	" "	"	"	Connecting Link with 52207	...
52206	---	" "	"	"	" " 52205 with 24041	...
775c	2035	" "	"	"	" Cap Screw	...
52207	---	" "	"	"	" Lubricating Pad (wood)	...
24041	2066	" "	"	"	Stud with 207 $\frac{1}{2}$ " F	...
207 $\frac{1}{2}$ "	1688	" "	"	"	" Clamping Screw	...
127222	2373	" "	"	"	Crank with 1036al, 1037al and 1065al	...
1065al	2035	" "	"	"	" Position Screw	...
127323	---	" "	"	"	Thread Guard	...
229d	2035	" "	"	"	" Screw	...
52307	2039	" "	"	"	Clamp with 51460f	...
51460f	2378	" "	"	"	" Screw	...
*52201	2064	<b>Oil Absorbent Wick</b>	...	...	...	...
52202	2064	" "	"	"	52201, with 52203, for lower cavity in head of arm	...
*52203	2040	" "	"	"	" Wire	...
127191	---	<b>Oil Tube, with 52184</b>	...	...	...	...
127091	2040	" "	"	"	Bracket	...
127092	---	" "	"	"	127091, with 127191, for oiling 52165	...
52184	2064	" "	"	"	Packing (cotton wick)	...
12391	2028	<b>Presser Bar (hollow)</b>	...	...	...	...
52338	1316	" "	"	"	Guide Bracket with 223c and 453c	...
453c	1316	" "	"	"	" Set Screw	...
5990	1503	" "	"	"	Litter	...
689c	1316	" "	"	"	" Screw	...
1520r	1317	" "	"	"	" Nut	...
12327	1316	" "	"	"	Lifting and Releasing Lever Bracket	...
127108	2029	" "	"	"	Spring	...
11170	1316	" "	"	"	" Washer	...
7298	2032	<b>Presser Foot Hinge Pin</b>	...	...	...	...
52437	---	" "	"	"	Plate	...
52438	---	" "	"	"	Shank	...
26231	2032	" "	"	"	Spring	...
52439	1502	<b>Presser Foot (spring hinged), complete, Nos. 7298, 26231, 52437 and 52438</b>	...	...	...	...
190d	1324	" "	"	"	" Screw	...
688j	1324	<b>Pressure Regulating Thumb Screw</b>	...	...	...	...

No.	Plate		
127095	2039	Rotating Hook with three 1253c	...
127096	2039	" " 127095 with 127102 and four 1053c	...
*127239	2039	" " 127096 with 40274, 127242 and three 1367d	...
127097	2039	" " 127096 with 40274 and three 1367d (for agents only)	...
127240	2039	" " 127239 with 52237	...
40264	2032	" " Bobbin	...
52235	2032	" " Case	...
52236	2032	" " 52235 with 591f, 1380d and 40394	...
40393	2032	" " Hinge, Nos. 2974, 40392 and 125320	...
127242	2378	" " Holder	...
52018	2032	" " Position Bracket	...
704j	1324	" " Screw	...
40392	2032	" " Latch	...
125320	2066	" " Lever	...
2974	2032	" " Fulcrum Pin	...
2975	2032	" " Spring	...
592e	1324	" " Stop Screw	...
591f	1324	" " Tension Regulating Screw	...
40394	2032	" " Spring	...
1380d	2035	" " Screw	...
52237	2032	" " complete, Nos. 592e, 2975, 40393 and 52236	...
127241	2032	" " 52237 with 127242 (for agents only)	...
40274	2032	" " Section	...
1367d	2035	" " Screw	...
1253c	2035	" " Set Screw	...
127059	2065	" " Shaft	...
127073	2039	" " Bevel Gear with two 1259c	...
127007	2029	" " Case (two pieces) with 121e and 50234d	...
50234d	2035	" " Plug Screw	...
121e	1324	" " Screw	...
1259c	2035	" " Set Screw	...
127004	2039	" " Bushing (back)	...
127043	2032	" " ( " ) 127004 with 52045	...
52045	2032	" " ( " ) Packing (cotton)	...
1143c	2035	" " ( " ) Set Screw	...
127005	2039	" " (front)	...
127044	2032	" " ( " ) 127005 with 52045	...
142008	2373	" " Oil Cup	...
52045	2032	" " ( " ) Packing (cotton)	...
1143c	2035	" " ( " ) Set Screw	...
144828	—	Rotating Hook with three 1253c	...
144829	—	Rotating Hook 144828 with 270083 and four 1053c	...
144830	—	Rotating Hook 144829 with 40274, 143346 and three 1367e	...
144832	—	Rotating Hook 144830 with 52237	...
144831	—	Rotating Hook 144829 with 40274 and three 1367e (for agents only)	...

No.	Plate		
52337	1316	Slack Thread Regulator	...
223c	1316	" " Set Screw	...
2102	2032	Tension Disc	...
1560c	2034	" Regulating Thumb Nut	...
32572	2032	" Releasing Disc	...
52145	1503	" Lever	...
12398	1316	" Hinge Pin	...
12329	1316	" Spring	...
32574	2032	" Pin	...
2103	2032	" Spring	...
*50304c	2034	" Stud	...
52098	2035	" 50304c with 1560c	...
50305c	2035	" Set Screw	...
52397	—	Tension, complete, Nos. 2103, 32572, 32574, 52083, 52098, 52394 and two 2102	...
52027	2032	Thread Guard (side of arm)	...
52454	2030	" Retainer	...
624c	2035	" Set Screw	...
127289	—	Thread Take-up, complete, Nos. 11204, 52025 and 127291	...
127290	2373	Thread Take-up Crank	...
127291	—	" " 127290 with 775c and 52206	...
1037al	2035	" Position Screw	...
1036al	2035	" Set Screw	...
52022	1503	Thread Take-up Lever with 52130	...
52023	2039	" Hinge Pin	...
52024	2039	" Link	...
11204	2033	" Hinge Pin	...
435c	1324	" Set Screw	...
52130	—	" Thread Eyelet Bushing	...
52025	—	Thread Take-up Lever, complete, Nos. 52022 to 52024	...
52394	2039	Thread Take-up Spring	...
52083	2032	" Regulator with 50305c	...
448c	1324	" Set Screw	...
26605	1502	Throat Plate, large needle hole, for 121446	...
26606	—	" small " " 121446	...
691f	1324	" Screw (2)	...
NOTE: No. 26605 is sent with this machine unless otherwise specified on order.			
139622	—	Drip Pan with four 3/4" wire nails	...

No. Plate

**PARTS COMPLETE**  
FOR  
**No. 96K45 MACHINE**

**For Light, Medium and Heavy Clothing and other work in Cloth. Maximum  
Stitch 5½ to the inch. Drop Feed. Vertical Trimmer. Knee Lifter.**

No. Plate  
\*127331 ~~Arm with two 50015~~ ... ..

*NOTE— Due to the accuracy required for gear alignment, Arm cannot be supplied  
separately and can only be sent out as a unit, Arm and Bed assembled*

16532	2032	Arm Dowel Pin (2)	...	...	...	...
52182	2066	" Oil Tube, with 52184, for oiling 52205	...	...	...	...
52183	2064	" " " " 52184, " " 52024	...	...	...	...
52180	2066	" " " (long) with 52184, for oiling 52022	...	...	...	...
52185	2066	" " " (short) " 42367, " " 52022	...	...	...	...
142087		" " " with Hole Cover and Holder	...	...	...	...
142069	2545	" " " 142087, with 52150, for oiling 127072 and 127074	...	...	...	...
<del>50015</del>	2033	" " " for oiling 127058 (2)	...	...	...	...
52150	2039	" " " Packing (braided cotton) for 142069	...	...	...	...
42367	2064	" " " " ( " " ) " 52185	...	...	...	...
52184	2064	" " " " (cotton wick) for 52180, 52182, 52183, and 127194	...	...	...	...
116e	1324	" Screw (back) (2)	...	...	...	...
854e	2035	" " (front) (2)	...	...	...	...
127024	2374	Arm Shaft (horizontal)	...	...	...	...
88619		" " ( " ) 127024 with 127223	...	...	...	...
127072	2039	" " ( " ) Bevel Gear with two 1036c	...	...	...	...
127070	2029	" " ( " ) " " Case (two pieces) with 121e	...	...	...	...
121e	1324	" " ( " ) " " " Screw	...	...	...	...
1036c	2035	" " ( " ) " " " Set Screw	...	...	...	...
52191	2040	" " ( " ) Flanged Bushing (back)	...	...	...	...
52192		" " ( " ) " " ( " ) 52191 with 52193 and 52194	...	...	...	...
52193	2040	" " ( " ) " " ( " ) Oil Pad (braided cotton)	...	...	...	...
52194	2064	" " ( " ) " " ( " ) Oil Pad (left)	...	...	...	...
446c	1324	" " ( " ) " " ( " ) Set Screw	...	...	...	...



No.	Plate				
52195	2040	<b>Arm Shaft</b> (horizontal) Flanged Bushing (front) ...			
52196	--	" " ( " ) " " ( " ) 52195 with			
				52193 and 52194	
52193	2040	" " ( " ) " " ( " ) Oil Pad			
				(braided cotton)	
52194	2064	" " ( " ) " " ( " ) Oil Pad (felt)			
435c	1324	" " ( " ) " " ( " ) Set Screw ...			
68350	2039	" " ( " ) Front Bearing Oil Cup (spring lid) ...			
144d	1324	" " ( " ) Screw ...			
127058	2028	" " (upright) ...			
127073	2039	" " ( " ) Bevel Gear (lower) with two 1259c ...			
1259c	2035	" " ( " ) " " ( " ) Set Screw ...			
127074	2039	" " ( " ) " " (upper) with two 1259c ...			
1259c	2035	" " ( " ) " " ( " ) Set Screw ...			
52492	2039	" " ( " ) Bushing (lower) ...			
432c	1324	" " ( " ) " " ( " ) Set Screw ...			
52493	2039	" " ( " ) " " (upper) ...			
435c	1324	" " ( " ) " " ( " ) Set Screw ...			
127146	2066	" Side Cap ...			
219d	1324	" " " Screw ...			
127079	2028	" " Cover ...			
50053d	2035	" " " Thumb Screw ...			
52239	2064	" Spool Pin and Thread Eyelet ...			
8879	1316	" " " Washer (cloth) ...			
127192	2064	<b>Arm Top Cover</b> ...			
127193	2064	" " " 127192 with 52183, 52239, 127187 and 127255			
52183	2064	" " " Oil Tube with 52184 ...			
52184	2064	" " " " " " Packing (cotton wick) ...			
127187	2040	" " " " " " (bent) with 42367 ...			
42367	2064	" " " " " " Packing (braided cotton)			
127255	2378	" " " Positioning Disc ...			
158j	1324	" " " Screw ...			
150459	2064	" " " Tension Bracket with 460c ...			
52183	2064	" " " " " " Oil Tube with 52184 ...			
52184	2064	" " " " " " " " Packing (cotton wick)			
127187	2040	" " " " " " " " (bent) with 42367			
42367	2064	" " " " " " " " Packing (braided cotton)			
158j	1324	" " " " " " Screw ...			
52239	2064	" " " " " " Spool Pin ...			
8879	1316	" " " " " " " " Washer (cloth) ...			
2455	1688	" " " " " " Disc ...			
41593	1316	" " " " " " Spring ...			
41594	1316	" " " " " " Stud ...			
460c	1324	" " " " " " Set Screw ...			
41595	1316	" " " " " " Thread Guide ...			

No.	Plate		
150460	2064	<b>Arm Top Cover Tension Bracket</b> , complete, Nos. 41593 to 41595, 52183, 52239, 127187, 127255, 150459 and two 2455	

NOTE No. ~~150460~~ is supplied with this machine unless No. ~~127193~~ is specified on order ~~150460~~

<del>52187</del> <sup>142033</sup>	2065	<b>Balance Wheel</b> (power, disc) 2 3/16" pulley, with two 448c ...	
<del>52063</del> <del>2024</del>		" " Oil Cover ...	
<del>210d</del> <del>1324</del>		" " " " " " Screw ...	
<del>448c</del> <del>1324</del>		" " " " " " Set Screw ...	

*52383		<b>Bed</b> ...	
--------	--	----------------	--

NOTE Due to the accuracy required for gear alignment, Bed cannot be supplied separately and can only be sent out as a unit, Arm and Bed assembled

12431		<b>Bed Slide</b> ...	
12432	2028	" " complete, Nos. 4307, 12431 and two 725c ...	
4307	2028	" " Spring ...	
725c	1324	" " " " " " Screw ...	

52102	2374	<b>Face Plate</b> ...	
176d	559	" " Screw (2) ...	
52053	2030	" " Thread Guard (lower) ...	
226d	1324	" " " " " " ( " ) Screw ...	
52170		" " " " " " (upper) ...	
226d	1324	" " " " " " ( " ) Screw ...	
52103		<b>Face Plate</b> , complete, Nos. 52053, 52102, 52170 and two 226d ...	

52452	2028	<b>Feed Bar</b> ...	
313c	1324	" " Screw Centre (2) ...	
1519c	2034	" " " " " " Nut (2) ...	
52165	2066	" Connecting Link ...	
375c	1324	" " " " " " Hinge Screw ...	
1518c	2034	" " " " " " " " Nut ...	
52073	2032	" " " " " " Stud ...	
50083c	2035	" " " " " " " " Set Screw ...	

127025	2376	<b>Feed Dog</b> , 9 teeth (12 teeth to the inch) ...	
50117c	2035	" " " " " " Screw (2) ...	

127224		<b>Feed and Feed Lifting Eccentric</b> with 448c, 52210 and 52211	
127226		" " " " " " 127224 with 127152 ...	
52210	1503	" " " " " " " " Lubricating Pad (wood, long)	
52211	1503	" " " " " " " " " " ( " short)	
448c	1324	" " " " " " " " Set Screw ...	
127152	2066	" " " " " " " " Sleeve ...	

No.	Plate	
20284	2029	<b>Feed Forked Connection</b> ... ..
52393	—	" " " " " 20284 with 375c, 1518e and 52165 ...
375c	1324	" " " " " Hinge Screw ... ..
1518e	2034	" " " " " " " Nut ... ..
52384	2029	<b>Feed Lifting Rock Shaft</b> ... ..
127156	2065	" " " " " Connecting Rod with 127157 and two 966e
*127157	—	" " " " " " " Cap ... ..
966e	2035	" " " " " " " Screw ... ..
375c	1324	" " " " " " " Hinge Screw ... ..
1518e	2034	" " " " " " " " " Nut ... ..
12376	2032	" " " " " Crank with 157c and 1813 ... ..
157c	1324	" " " " " " " Clamping Screw ... ..
1813	2034	" " " " " " " Roller and Stud ... ..
50191c	2034	" " " " " " " Screw Centre (2) ... ..
1513j	1317	" " " " " " " Nut (2) ... ..
52385	—	<b>Feed Lifting Rock Shaft, complete, Nos. 12376 and 52384</b> ... ..
52074	2033	<b>Feed Regulator with 50083c</b> ... ..
52118	—	" " " " " 52074 with 52073 ... ..
52093	—	" " " " " 52118 with 818d ... ..
1128c	2035	" " " " " Hinge Screw ... ..
818d	2035	" " " " " Thumb Screw ... ..
52386	2029	<b>Feed Rock Shaft</b> ... ..
29633	2032	" " " " " Crank with 157c ... ..
157c	1324	" " " " " " " Clamping Screw ... ..
50191c	2034	" " " " " " " Screw Centre (2) ... ..
1513j	1317	" " " " " " " Nut (2) ... ..
52387	—	<b>Feed Rock Shaft, complete, Nos. 29633 and 52386</b> ... ..
127026	2377	<b>Knife (narrow)</b> ... ..
127027	2377	" (wide) ... ..
620c	2377	" Adjusting Screw ... ..
52104	2374	" Bar with 2301 ... ..
24431	2377	" " Crank with 191c ... ..
1162c	2377	" " " " " Coupling Pin ... ..
1564d	2377	" " " " " " " Head ... ..
2297	2377	" " " " " " " Spring ... ..
2022	2033	" " " " " " " Pin ... ..
191c	—	" " " " " " " Set Screw ... ..
24432	—	" " " " " complete, Nos. 1162c, 1564d, 2297 and 24431
127028	2377	" " " " " Driving Crank (forked) ... ..
16564	2377	" " " " " " " Bracket ... ..

No.	Plate	
127029	—	<b>Knife Bar Driving Crank Bracket, complete, Nos. 2022, 16564, 24432 and 127028</b>
647c	2377	" " " " " " " Screw (2) ... ..
24122	2377	" " " " " " " Lifting Spring ... ..
24123	2377	" " " " " " " Case ... ..
*24124	—	" " " " " " " Guide ... ..
24906	2377	" " " " " " " 24124 with 2523 and 24125 ... ..
*24125	—	" " " " " " " Bracket ... ..
621j	2377	" " " " " " " " " Screw ... ..
2523	2377	" " " " " " " " " Pin ... ..
2301	2377	" " " " " " " " " Stop Pin ... ..
52107	—	<b>Knife Bar, complete, Nos. 621j, 24109, 24906, 52104, 52108 and three 50117e</b>
52108	2377	" " " " " " " Holder with 620c, 2291 and two 223j ... ..
24109	2377	" " " " " " " Handle ... ..
50117c	2035	" " " " " " " " " Screw ... ..
50117e	2035	" " " " " " " " " Screw ... ..
223j	1316	" " " " " " " " " Screw ... ..
2291	2377	" " " " " " " " " Washer ... ..
127135	2373	<b>Needle Bar (hollow) with 140239al</b> ... ..
127137	—	" " " " " 127135 with 127136 ... ..
52200	2373	" " " " " Bushing (lower) ... ..
1133c	2035	" " " " " ( " ) Set Screw ... ..
52111	2373	" " " " " (upper) ... ..
1133c	2035	" " " " " ( " ) Set Screw ... ..
52205	2066	" " " " " Connecting Link with 52207 ... ..
52206	—	" " " " " " " 52205 with 24041 ... ..
775c	2035	" " " " " " " Cap Screw ... ..
52207	—	" " " " " " " Lubricating Pad (wood) ... ..
24041	2066	" " " " " " " Stud with 207qF ... ..
207qF	1688	" " " " " " " Clamping Screw ... ..
127223	2373	" " " " " Crank (eccentric) with 1036al, 1037al and 1065al ... ..
127032	2373	" " " " " ( " ) Sleeve ... ..
1065al	2035	" " " " " " " Position Screw ... ..
127136	2378	" " " " " " " Thread Guide ... ..
140239al	2378	" " " " " " " Set Screw ... ..
*52201	2064	<b>Oil Absorbent Wick</b> ... ..
52202	2064	" " " " " 52201, with 52203, for lower cavity in head of arm
*52203	2040	" " " " " " " Wire ... ..
142033	—	<b>Machine Pulley (disc) "V" belt groove (outside diam. of belt groove 2-9"), with two 435al</b> ... ..
52063	2029	<b>Machine Pulley Oil Cover</b> ... ..
210d	1324	" " " " " " " " " L, for oiling 52165
435al	1324	" " " " " " " " " Screw ... ..
		" " " " " " " " " Set Screw ... ..

No.	Plate	
12391	2028	<b>Presser Bar</b> (hollow) ...
52338	1316	" " Guide Bracket with 223c and 453c ...
453c	1316	" " " " Set Screw ...
52016	1316	" " Lifter ...
689c	1316	" " " Screw ...
1520r	1317	" " " Nut ...
12327	1316	" " Lifting and Releasing Lever Bracket ...
127108	2029	" " Spring ...
11170	1316	" " " Washer ...

127033	2376	<b>Presser Foot</b> for $\frac{1}{16}$ " to $\frac{11}{16}$ " gauges ...
127034	2376	" " " $\frac{3}{16}$ " gauge and above ...
190d	1324	" " Screw ...

NOTE:—No. 127033,  $\frac{1}{16}$ " gauge and No. 127034,  $\frac{3}{16}$ " gauge, are sent with machine unless other gauges are specified on order.

50373w	2378	<b>Pressure Regulating Thumb Screw</b> ...
--------	------	--

127095	2039	<b>Rotating Hook</b> with three 1253c ...
127096	2039	" " 127095 with 127102 and four 1053c ...
127239	2039	" " 127096 " 40274, 127242 and three 1367d ...
127097	2039	" " 127096 " 40274 and three 1367d (for agents only)
127240	2032	" " 127239 with 52237 ...
40264	2032	" " Bobbin ...
52235	2032	" " " Case ...
52236	2032	" " " 52235 with 5911, 1380d and 10394 ...
40393	2032	" " " Hinge Nos. 2974, 10392 and 125320 ...
127242	2378	" " " Holder ...
52018	2032	" " " " Position Bracket ...
704j	1324	" " " " " Screw ...
40392	2032	" " " " Latch ...
125320	2066	" " " " Lever ...
2074	2032	" " " " Fulcrum Pin ...
2975	2032	" " " " Spring ...
592c	1324	" " " " Stop Screw ...
591f	1324	" " " " Tension Regulating Screw ...
40394	2032	" " " " Spring ...
1380d	2035	" " " " Screw ...
52237	2032	" " " " complete, Nos. 592c, 2975, 10393 and 52236 ...
127241	2032	" " " " 52237 with 127242 (for agents only)
40274	2032	" " " Section ...
1367d	2035	" " " Screw ...
1253c	2035	" " " Set Screw ...

144828	—	Rotating Hook with
144829	—	Rotating Hook 144
144830	—	Rotating Hook 144f
		1367e ...
144832	—	Rotating Hook 144f
144831	—	Rotating Hook 144
		(for agents only)

No.	Plate	
127007	2029	<b>Rotating Hook Shaft Bevel Gear Case</b> (two pieces) with 121e and 50234d ...
50234d	2035	" " " " " " Plug Screw ...
121e	1324	" " " " " " Screw ...
1259c	2035	" " " " " " Set Screw ...
127004	2039	" " " " Bushing (back) ...
127043	2032	" " " " " ( " ) 127004 with 52045 ...
52045	2032	" " " " " ( " ) Packing (cotton) ...
1143c	2035	" " " " " ( " ) Set Screw ...
127005	2039	" " " " " (front) ...
127044	2032	" " " " " ( " ) 127005 with 52045 ...
142008	2373	" " " " " ( " ) Oil Cup ...
52045	2032	" " " " " ( " ) Packing (cotton) ...
1148c	2035	" " " " " ( " ) Set Screw ...
127102	2039	" " " " Thread Guard ...
1053c	2035	" " " " " Screw ...

270013

52115	2378	<b>Slack Thread Regulator</b> ...
223c	1316	" " " Set Screw ...

2102	2032	<b>Tension Disc</b> ...
1560c	2034	" Regulating Thumb Nut ...
32572	2032	" Releasing Disc ...
43944	1316	" " Lever ...
12398	1316	" " " Hinge Pin ...
12329	1316	" " " Spring ...
32574	2032	" " " Pin ...
2103	2032	" Spring ...
*50304c	2034	" Stud ...
52098	2035	" " 50304c with 1560c ...
50305c	2035	" " Set Screw ...
52397	2035	<b>Tension, complete, Nos. 2103, 32572, 32574, 52083, 52098, 52394 and two 2102</b> ...

52027	2032	<b>Thread Guard</b> (side of arm) ...
52454	2030	" Retainer ...
624c	2035	" " Set Screw ...
52208	2035	<b>Thread Take-up, complete, Nos. 11204, 52025 and 52209</b> ...

52021	2035	<b>Thread Take-up Crank</b> ...
52209	2035	" " " 52021 with 775e and 52206 ...
1037ad	2035	" " " Position Screw ...
1036ad	2035	" " " Set Screw ...

## No. 96K45 MACHINE PARTS

No.	Plate						
52022	1503	<b>Thread Take-up Lever</b> with 52130	...	...	...	...	...
52023	2039	" " " Hinge Pin	...	...	...	...	...
52024	2039	" " " Link	...	...	...	...	...
11204	2033	" " " " Hinge Pin	...	...	...	...	...
435c	1324	" " " " " " Set Screw	...	...	...	...	...
52130	-	" " " Thread Eyelet Bushing	...	...	...	...	...
52025	-	<b>Thread Take-up Lever</b> , complete, Nos. 52022 to 52024	...	...	...	...	...
52394	2039	<b>Thread Take-up Spring</b>	...	...	...	...	...
52083	2032	" " " Regulator with 50305c	...	...	...	...	...
448c	1324	" " " " Set Screw	...	...	...	...	...
5729	-	<b>Throat Plate</b> Body	...	...	...	...	...
†142032	2376	" " Cutting Bar for 127036	...	...	...	...	...
†52131	2376	" " " " " 127040	...	...	...	...	...
578d	2376	" " " " Screw	...	...	...	...	...
127035	2376	" " Slide	...	...	...	...	...
578d	2376	" " " Adjusting Screw	...	...	...	...	...
†127036	2376	<b>Throat Plate</b> (small needle hole), complete, Nos. 5729, 127035, 142032 and three 578d, for 127025	...	...	...	...	...

NOTE -- No. 127036,  $\frac{1}{8}$ " gauge, is sent with this machine unless another gauge is specified on order and an additional Cutting Bar No. 142032,  $\frac{3}{16}$ " gauge is also sent with machine.

†127040	2376	<b>Throat Plate</b> (large needle hole), complete, Nos. 5729, 52131, 127035 and three 578d, for 127025	...	...	...	...	...
691f	1324	<b>Throat Plate Screw</b>	...	...	...	...	...
139622	—	<b>Drip Pan</b> with four $\frac{3}{4}$ " wire nails	...	...	...	...	...

†NOTE. When ordering state required distance of trimmed edge from seam.

## Iron Base

No.	Plate							
19219	2033	Bed Frame Cushion (leather)	...	...	...	...	...	...
158c	1324	" " " Screw	...	...	...	...	...	...
19220	2033	" " " Spring	...	...	...	...	...	...
19226	2039	" " Hinge Connection	...	...	...	...	...	...
19398		" " " " 19226 with 211f and 19397	...	...	...	...	...	...
19397	2033	" " " " Cap	...	...	...	...	...	...
211f	2035	" " " " Screw	...	...	...	...	...	...
16555	2033	" " " Plate	...	...	...	...	...	...
14010	2033	" " " " Rivet	...	...	...	...	...	...
20067	1513	<b>Bed Frame</b> with two each 16555, 19398, four each 19219, 19220, six each 14010, wood screws $1\frac{1}{4}$ " No. 12, and eight 158c	...	...	...	...	...	...

## Tape Holder

(8 IN. DISC)

FOR 96K43 MACHINE

No.	Plate							
26061	7708	Bracket Wire with disc	...	...	...	...	...	...
26062	7708	Disc (adjustable) with 35925 and 50053d	...	...	...	...	...	...
35925		" Hub	...	...	...	...	...	...
50053d	2035	" Thumb Screw	...	...	...	...	...	...
26063	7708	<b>Tape Holder</b> (straight), 8" disc, complete, Nos. 26061 and 26062	...	...	...	...	...	...
190d	1324	" " " Set Screw	...	...	...	...	...	...

## Accessories

No.	Plate							
40264	2032	Fobbin (2)	...	...	...	...	...	...
12361	2039	Machine Hinge Connection (2)	...	...	...	...	...	...
36569	2031	Oiler	...	...	...	...	...	...
25537	2031	Screw Driver (large)	...	...	...	...	...	...
120378	2031	" " (small)	...	...	...	...	...	...
8908		Wrench for 96K45 Machine	...	...	...	...	...	...
8909		" " 96K45 "	...	...	...	...	...	...
		Screw (wood), $\frac{1}{2}$ " No. 5, for 96K45 Machine (4)	...	...	...	...	...	...

# Bobbin Winders

## BOBBIN WINDER (swinging automatic, left hand) for 40264

No.	Plate		...	...	...	...	...
41913	2007	Bracket with 457c	...	...	...	...	...
41583	2007	Frame with 457c	...	...	...	...	...
34105	2007	" Hinge Pin	...	...	...	...	...
457c	1324	" " " Set Screw	...	...	...	...	...
41914	2007	" Spring	...	...	...	...	...
41585	2007	Pulley with 171d	...	...	...	...	...
171d	1324	" Set Screw	...	...	...	...	...
41586	2007	Spindle	...	...	...	...	...
41587	2007	Stop Latch	...	...	...	...	...
42614	2007	" " Hinge Stud	...	...	...	...	...
457c	1324	" " " " Set Screw	...	...	...	...	...
7958	2032	" " Stop Pin	...	...	...	...	...
41588	2007	" " Tripping Arm with 185h	...	...	...	...	...
185h	1324	" " " " Clamping Screw	...	...	...	...	...
60845	2007	Bobbin Winder, Nos. 7958, 34105, 41583, 41585 to 41588, 41913, 41914 and 42614	...	...	...	...	...
41915	—	Bobbin Winder, complete, Nos. 880e, 25446 and 60845	...	...	...	...	...
880e	2035	" " Screw	...	...	...	...	...
25446	2033	" " Washer	...	...	...	...	...

*This Bobbin Winder is sent with machine unless otherwise specified on order.*

## BOBBIN WINDER (swinging automatic, right hand) for use with Individual Motor.

*White 10-55*  
*(Arm Top Cover Tension Bracket No. 127193 is supplied in place of No. 150160 when this Bobbin Winder is fitted to machine.)*

No.	Plate		...	...	...	...	...
41339	1687	Base	...	...	...	...	...
41340	1687	Frame	...	...	...	...	...
1429d	1688	" Hinge Screw	...	...	...	...	...
41341	1687	" Spring	...	...	...	...	...
207d	1688	" " Screw	...	...	...	...	...
41342	1687	Pulley with 200f	...	...	...	...	...
200f	1688	" Set Screw	...	...	...	...	...
41343	1688	Spindle	...	...	...	...	...
27306	1688	Spool Pin	...	...	...	...	...
27307	1687	" Stand	...	...	...	...	...
†27308	1687	" " complete, Nos. 418e, 1562j, 2106, 40141, 41241, 27306, 27307, two each 2455 and wood screws 1" No. 10	...	...	...	...	...
41241	1687	Spool Washer (cloth)	...	...	...	...	...
41344	1688	Stop Latch	...	...	...	...	...
41345	1688	" " Finger	...	...	...	...	...
152f	1688	" " " Screw	...	...	...	...	...
1430d	1688	" " Hinge Screw	...	...	...	...	...
1550h	1688	" " " " Nut	...	...	...	...	...
41346	1688	" " Lever	...	...	...	...	...
1430d	1688	" " " Hinge Screw	...	...	...	...	...
2455	1688	Tension Disc	...	...	...	...	...
1562j	1688	" Regulating Thumb Nut	...	...	...	...	...
418e	1688	" Screw Stud	...	...	...	...	...
10141	1688	" Spring	...	...	...	...	...
2106	1688	" Thread Guide	...	...	...	...	...
60456	—	Bobbin Winder, Nos. 152f, 207d, 1429d, 1550h, 41339 to 41346, and three 1430d	...	...	...	...	...
41347	1687	Bobbin Winder, 60456, with two each 9331 and wood screws 1" No. 10 R.H.B.	...	...	...	...	...
41348	—	Bobbin Winder (swinging automatic, right hand), complete, Nos. 27308 and 41347	...	...	...	...	...
—	—	Bobbin Winder Screw (wood) 1" No. 10 R.H.B.	...	...	...	...	...
9331	1688	" " " Washer	...	...	...	...	...

*†As No. 27308 can be supplied either Plated or Japanned, it is necessary, when ordering, to state which is required.*

## BOBBIN WINDER (swinging automatic, right hand)

for machines when used on Power Table.

*Alite 10-55**(Arm Top Cover Tension Bracket No. 127193 is supplied in place of No. 150160 when this Bobbin Winder is fitted to machine.)*

No.	Plate	
225433	10885	Bobbin Winder and Tension Bracket Base ... ..
225453	10884	Frame with 202277 and 259660 ... ..
225454	10884	" Hinge Pin ... ..
202277	"	" Oil Packing (wick) ... ..
259660	"	" " Well Washer ... ..
225455	10884	" Spring ... ..
225456	10884	" " Plunger ... ..
202473	10885	Pulley with 200380c ... ..
200380c	"	" Set Screw ... ..
225381	10884	Spindle ... ..
225444	10884	Stop Latch ... ..
200056e	10884	" " Screw ... ..
225458	10884	" " Thumb Lever ... ..
225459	10884	" " " " Hinge Stud ... ..
225459	10884	" " " " Joint Stud ... ..
202478	10884	" " Trip Lever ... ..
200299h	10884	" " " " Hinge Screw ... ..
225461	10881	Tension Bracket with 201499j ... ..
200082d	10881	" " Screw ... ..
228026	10884	" " " Washer ... ..
2102	2032	" Disc ... ..
13710	"	" Spring ... ..
201499j	10881	" Stud ... ..
201572j	10881	" " Thumb Nut ... ..
225462	10881	Tension Bracket, complete, Nos. 13710, 201572j, 225461 and two 2102 ... ..
225382	10885	<b>Bobbin Winder</b> , complete, Nos. 200056e, 200082d, 200299h, 202473, 202478, 225381, 225433, 225444, 225453 to 225456, 225458, 225462, 228026, two each 225459 and wood screw $\frac{3}{8}$ " No. 12 R.H.B. ... ..

## Attachments

*When ordering Binders send sample of the binding and of the material to be bound.*

## BINDER for Cap Peak Work

No.	Plate	
85678	559	Feed Dog ... ..
85459	559	Folder Base ... ..
85460	559	" (top) ... ..
207d	1688	" ( " ) Binding Screw ... ..
85461	"	" (bottom) ... ..
SS50d	186	" ( " ) Binding Screw ... ..
85462	559	" Roller Guide, Nos. 701d, 85463 and 85464 ... ..
SS50d	186	" " " Binding Screw ... ..
85463	"	" " " Bracket ... ..
85464	"	" " " Roller ... ..
701d	1324	" " " " Screw ... ..
176d	559	" Screw (to fasten to machine) ... ..
85325	186	" " Washer ... ..
85458	559	Folder, complete, Nos. 85459 to 85462, two 207d and four SS50d
85679	559	Presser Foot ... ..
85680	559	Throat Plate ... ..
85681	559	<b>Binder</b> , complete, Nos. 85458, 85678 to 85680, two each 176d and 85325 ... ..

## BINDER for Cardigan Jackets

No.	Plate	
85682	558	Feed Dog ... ..
85336	"	Folder Base ... ..
85337	"	" Folding Plate (top) ... ..
85338	"	" " " (bottom) ... ..
233d	1324	" " " Screw for 85337 and 85338 ... ..
SS50d	186	" Screw ... ..
85325	186	" " Washer ... ..
85335	"	Folder, complete, Nos. 85336 to 85338 and four 233d ... ..

No.	Plate	
85683	558	Presser Foot ... ..
85324		Tape Tension Pin (bent) ... ..
85323		" " " (straight) ... ..
85340		" " Plate ... ..
85339	558	" " complete, Nos. 85324, 85340 and four 85323 ... ..
207d	1688	" " Screw ... ..
85325	186	" " " Washer ... ..
85684	558	Throat Plate ... ..
85685	558	<b>Binder</b> , complete, Nos. SS50d, 207d, 85335, 85339, 85682 to 85684 and two 85325 ... ..

#### BINDER, $\frac{1}{2}$ ", for General Work

No.	Plate	
85686	558	Feed Dog ... ..
85320	558	Folder ... ..
SS50d	186	" Screw ... ..
85325	186	" " Washer ... ..
85687		Presser Foot Bracket ... ..
85688		" " " Hinge Pin ... ..
85689		" " Sole ... ..
85690	558	" " (hinged), complete, Nos. 85687 to 85689 ... ..
85324		Tape Tension Pin (bent) ... ..
85323		" " " (straight) ... ..
85322		" " Plate ... ..
85321	557	" " complete, Nos. 85322, 85324 and eight 85323 ... ..
SS50d	186	" " Screw ... ..
85325	186	" " " Washer ... ..
85691	558	Throat Plate ... ..
85692	558	<b>Binder</b> , complete, Nos. 85320, 85321, 85686, 85690, 85691, two each SS50d and 85325 ... ..

#### BINDER, $\frac{1}{2}$ ", for Stay Work

No.	Plate	
85693	557	Feed Dog ... ..
85614		Folder ... ..
SS65d	1324	" Screw ... ..
85694		Presser Foot Bracket ... ..
85616		" " " Hinge Pin ... ..
85695		" " Sole ... ..
85696	557	" " (hinged), complete, Nos. 85616, 85694 and 85695 ... ..
85324		Tape Tension Pin (bent) ... ..
85323		" " " (straight) ... ..
85322		" " Plate ... ..
85321	557	" " complete, Nos. 85322, 85324 and eight 85323 ... ..
SS50d	186	" " Screw ... ..
85325	186	" " " Washer ... ..
85697	557	Throat Plate ... ..
85698	557	<b>Binder</b> , complete, Nos. SS50d, SS65d, 85321, 85325, 85614, 85693, 85696 and 85697 ... ..

#### BINDER, $\frac{1}{2}$ ", for Stay Work

No.	Plate	
85699	186	Base ... ..
85597	186	Binder ... ..
85324		Tape Tension Pin (bent) ... ..
85323		" " " (straight) ... ..
85700	186	Binder and Tension only, complete, Nos. 85324, 85597, 85699 and nine 85323 ... ..
SS50d	186	" Screw ... ..
85325	186	" " Washer ... ..
85701	186	Feed Dog ... ..
85702		Presser Foot Bracket ... ..
85703		" " " Hinge Pin ... ..
85704		" " Sole ... ..
85705	186	" " (hinged), complete, Nos. 85702 to 85704 ... ..
85706	186	Throat Plate ... ..
85707	186	<b>Binder</b> , complete, Nos. SS50d, 85325, 85700, 85701, 85705 and 85706 ... ..



**BINDER,  $\frac{9}{16}$ ", for Stay Work**

No.	Plate								
85711	187	Base	...	...	...	...	...	...	...
85603	187	Binder	...	...	...	...	...	...	...
85604	187	Folder	...	...	...	...	...	...	...
207d	1688	" Screw	...	...	...	...	...	...	...
85325	186	" " Washer	...	...	...	...	...	...	...
85605	187	Tape Guide	...	...	...	...	...	...	...
85606	187	" " Bracket	...	...	...	...	...	...	...
207d	1688	" " " Screw	...	...	...	...	...	...	...
85325	186	" " " Washer	...	...	...	...	...	...	...
207d	1688	" " " Screw	...	...	...	...	...	...	...
85325	186	" " " Washer	...	...	...	...	...	...	...
85607	"	" Tension Pin	...	...	...	...	...	...	...
85712	187	<b>Binder, Folder and Tension</b> only, complete, Nos. 85603 to 85606, 85711, three each 207d, 85325 and seven 85607	...	...	...	...	...	...	...
SS50d	186	Binder Screw	...	...	...	...	...	...	...
85325	186	" " Washer	...	...	...	...	...	...	...
85701	186	Feed Dog	...	...	...	...	...	...	...
85702	"	Presser Foot Bracket	...	...	...	...	...	...	...
85703	"	" " " Hinge Pin	...	...	...	...	...	...	...
85704	"	" " Sole	...	...	...	...	...	...	...
85705	186	" " (hinged), complete, Nos. 85702 to 85704	...	...	...	...	...	...	...
85706	186	Throat Plate	...	...	...	...	...	...	...
85713	187	<b>Binder</b> , complete, Nos. SS50d, 85325, 85701, 85705, 85706 and 85712	...	...	...	...	...	...	...

**CORDER (bowl), for Top Cording**

No.	Plate								
85868	201	Corder Bow	...	...	...	...	...	...	...
85869	201	Presser Foot	...	...	...	...	...	...	...
759d	1324	" " Thumb Screw	...	...	...	...	...	...	...
85870	201	<b>Corder (bowl)</b> , complete, Nos. 759d, 85868 and 85869	...	...	...	...	...	...	...

**CORDER, for Top Cording**

No.	Plate								
85783		Base	...	...	...	...	...	...	...
85871		Guide Finger with 85411, 85872 and two 85416	...	...	...	...	...	...	...
SS28b	1324	" " Adjusting Screw	...	...	...	...	...	...	...
85411		" " Eyelet	...	...	...	...	...	...	...
85413		" " Hinge Pin	...	...	...	...	...	...	...
879d	2035	" " Locking Thumb Screw	...	...	...	...	...	...	...
85872		" " Tip	...	...	...	...	...	...	...
85416		" " " Rivet	...	...	...	...	...	...	...
85873	1320	<b>Corder only</b> , complete, Nos. SS28b, 879d, 85413, 85783 and 85871	...	...	...	...	...	...	...
85874	1320	Presser Foot	...	...	...	...	...	...	...
85875	1320	<b>Corder</b> , complete, Nos. SS41d, 85412, 85873 and 85874	...	...	...	...	...	...	...
SS41d	1320	" Screw (to fasten to machine)	...	...	...	...	...	...	...
85412	1320	" " Washer	...	...	...	...	...	...	...

**CORDER GUIDE (Adjustable)**

No.	Plate								
85382		Extension Guide	...	...	...	...	...	...	...
228d	1324	" " Screw	...	...	...	...	...	...	...
85876		Presser Foot	...	...	...	...	...	...	...
85877	562	<b>Corder Guide</b> , complete, Nos. 228d, 85382 and 85876	...	...	...	...	...	...	...
85881	562	<b>Cording and Hemming Foot</b>	...	...	...	...	...	...	...
86182	562	<b>Cording Foot</b> (grooved on right side)	...	...	...	...	...	...	...

**CRIMPING SET**

No.	Plate								
85882	557	Feed Dog	...	...	...	...	...	...	...
85883		Presser Foot	...	...	...	...	...	...	...
85391		" " Spring	...	...	...	...	...	...	...
219d	1324	" " " Screw	...	...	...	...	...	...	...
85884	557	" " complete, Nos. 219d, 85391 and 85883	...	...	...	...	...	...	...
85885	557	Throat Plate	...	...	...	...	...	...	...
85886	557	<b>Crimping Set</b> , complete, Nos. 85882, 85884 and 85885	...	...	...	...	...	...	...

## FELLING FEET

No.	Plate	
85896	201	Felling Foot, $\frac{3}{16}$ " fell
85897	562	" " (steel), $\frac{3}{16}$ " fell

## FINGER GUARD

No.	Plate	
86417	1510	Finger Guard
102d	1324	" " Binding Screw
86478	1510	" " Bracket with 207f
207f	1688	" " " Screw
86479	1510	<b>Finger Guard</b> , complete, Nos. 102d, 86417 and 86478

## GATHERING FEET

No.	Plate	
85955	562	Gathering Foot
86193	2545	" " (slotted)

## HEMMERS

*When ordering Hemmers state width of hem in addition to the part number*

No.	Plate	
86005	88	Hemmer ( $\frac{3}{16}$ " to $\frac{7}{8}$ ", in grades of $\frac{1}{16}$ " )
86008	88	" ( $1$ " to $1\frac{1}{4}$ ", in grades of $\frac{1}{4}$ " )
86010	88	" ( $1\frac{3}{8}$ " and $1\frac{1}{2}$ " )
85447	88	" Base with SS54e
SS54e	1324	" " Stud Screw
NN40d	88	" " " " Thumb Nut
85448	88	" " " " " Washer
85446		<b>Hemmer Base</b> , complete, Nos. NN40d, 85447 and 85448

## HEMMER FEET

No.	Plate	
86025	562	$\frac{1}{16}$ " to $\frac{3}{32}$ " hem, in grades of $\frac{1}{32}$ "
86537		$\frac{1}{16}$ " flat sole
86538		$\frac{3}{32}$ " " " "
86539	1931	$\frac{1}{8}$ " " " "
86540		$\frac{5}{32}$ " " " "
86541		$\frac{3}{16}$ " " " "
86542		$\frac{7}{32}$ " " " "
86543		$\frac{1}{4}$ " " " "

## HEMMER FEET—Contd.

No.	Plate	
86544		$\frac{1}{16}$ " flat sole, with groove
86545		$\frac{3}{32}$ " " " " "
86546	1931	$\frac{1}{8}$ " " " " "
86547		$\frac{5}{32}$ " " " " "
86548		$\frac{3}{16}$ " " " " "
86549		$\frac{7}{32}$ " " " " "
86550		$\frac{1}{4}$ " " " " "

## PRESSER FOOT

No.	Plate	
86188	958	Presser Foot (narrow) for narrow tucking

## QUILTER

No.	Plate	
86041	958	Clamp with 207d
207d	1688	" Screw
86042	958	Rod
86043	958	<b>Quilter</b> , complete, Nos. 86041 and 86042

## TUCKERS (long arm)

No.	Plate	
36387	1315	Space Guide
35510	1315	" " Base with 35512, 35514 and two 1426e
402d	1317	" " " Screw
35511	1317	" " Indicator
35512	1317	" " Pin
35513	1317	" " Stop (left)
35514	1317	" " " ( " ) Guide Pin
1426e	1317	" " " ( " ) Screw Stud
1657d	1317	" " " ( " ) Thumb Nut
17718	1317	" " " ( " ) " " Washer
35515	1317	" " " (right)
1426e	1317	" " " ( " ) Screw Stud
1657d	1317	" " " ( " ) Thumb Nut
17718	1317	" " " ( " ) " " Washer
50053d	2035	" " Thumb Screw
36388		<b>Space Guide</b> , complete, Nos. 35510, 35511, 35513, 35515, 36387, 50053d, two each 1657d and 17718

# Knee Lifter

## 1507e — Rock Shaft Knee Plate Arm Bracket Position Nut S

No.	Plate						
5596	2028	Bell Crank	...	...	...	...	...
5598	2028	" "	5596 with 5599, 5601 and 5735	...	...	...	...
5599	2028	" "	Bracket	...	...	...	...
178e	1324	" "	" Screw	...	...	...	...
5601	2032	" "	Hinge Pin	...	...	...	...
5735	2032	" "	Spring	...	...	...	...

12237	2379	Lifting Lever with 448c	...	...	...	...	...
52028	2029	" "	Connecting Rod	...	...	...	...
12416	1316	" "	" " Joint	...	...	...	...
76d	1324	" "	" " " Hinge Screw	...	...	...	...
1521e	2034	" "	" " Lock Nut	...	...	...	...
802d	2035	" "	Hinge Screw	...	...	...	...
12241	1316	" "	Link	...	...	...	...
766d	1324	" "	" Hinge Screw	...	...	...	...
12240	1316	" "	Pin	...	...	...	...
448c	1324	" "	" Set Screw	...	...	...	...

2763	2379	Rock Shaft	...	...	...	...	...
97502	1815	" "	Bracket	...	...	...	...
		" "	" Screw (wood) 1" No. 10	...	...	...	...
2765	2379	" "	Knee Arm	...	...	...	...
2768		" "	" " 2765 with 2766 and 2767	...	...	...	...
2766	2379	" "	" " Hub with 356c	...	...	...	...
356c	1324	" "	" " Set Screw	...	...	...	...
2767	2379	" "	" Plate with 356c	...	...	...	...
356c	1324	" "	" " Set Screw	...	...	...	...
6337	2379	" "	Lifting Bracket with two 356c	...	...	...	...
2778	2379	" "	" " Hook	...	...	...	...
356c	1324	" "	" " Set Screw	...	...	...	...
356c	1324	" "	" " Set Screw	...	...	...	...
2770	2379	" "	Stop Dog with 356c	...	...	...	...
356c	1324	" "	" " Set Screw	...	...	...	...

84789 2379 **Rock Shaft**, complete, Nos. 2763, 2768, 2770, 2778, 6337, two 97502 and four wood screws 1" No. 10

85246 — **Knee Lifter**, complete, Nos. 76d, 766d, 802d, 1521e, 5598, 12237, 12240, 12241, 12416, 52028, 84789 and two 178e

No.	Plate						
35517	1309	Tuck Guide Arm	...	...	...	...	...
1177d	1317	" " Screw	...	...	...	...	...
35518	1309	" " Base	...	...	...	...	...
50134e	1317	" " Screw Stud	...	...	...	...	...
36389	1309	" " Bracket	...	...	...	...	...
307c	1317	" " Screw Centre	...	...	...	...	...
1513j	1317	" " " Nut	...	...	...	...	...
36390	1317	" " Spring	...	...	...	...	...
36391	1315	" " " Plate	...	...	...	...	...
9d	1317	" " " Screw	...	...	...	...	...
423c	1317	" " " Stop Screw	...	...	...	...	...
1520r	1317	" " " " Nut	...	...	...	...	...
36392	1309	" " Frame	...	...	...	...	...
36393	1317	" " " Spring	...	...	...	...	...
1510e	1317	" " " " Nut	...	...	...	...	...
35524	1317	" " " Washer	...	...	...	...	...
803c	1317	" " " Stop Screw	...	...	...	...	...
1520r	1317	" " " " Nut	...	...	...	...	...
35511	1317	" " Indicator	...	...	...	...	...
35525	1309	" " Plate	...	...	...	...	...
1115f	1317	" " Screw	...	...	...	...	...

36394 Tuck Guide, complete, Nos. 9d, 123c, 803c, 1510e, 35511, 35517, 35518, 35524, 35525, 36389 to 36393, 50134e, two each 307c, 1115f, 1177d, 1513j, 1520r and three wood screws 1 1/4" No. 10

36395 **Tucker** (long arm), complete, 35528, 36388, 36394 and two 402d

52031 967 Feed Dog for shirt work

35528 1510 Presser Foot (wide) for 36395

40322 1510 " " (narrow) for 36395

36654 1510 " " for tucking shirt bosoms, for 36670

52032 Throat Plate, large needle hole, for 52031

52033 967 " " small " " " 52031

36670 **Tucker** (long arm), complete, for tango tucking, Nos. 36388, 36394, 36654 and two 402d

# Knife Grinder

FOR 96K45 MACHINE

for Nos. 127026 and 127027

No.	Plate						
27565	2380	Emery Wheel, 2" diam.	...	...	...	...	...
1508j	22214	" " Clamping Nut	...	...	...	...	...
27822	22214	" " " " Washer	...	...	...	...	...
27567	22214	" " Shaft	...	...	...	...	...
60934		" " " 27567 with 1508j, 27565, 27569 and 27822	...	...	...	...	...
27568	22214	" " " Oil Hole Cover (rubber)	...	...	...	...	...
27569	22214	" " " Pulley	...	...	...	...	...
310k	22214	" " " Screw Centre	...	...	...	...	...
1516j	22214	" " " " " Nut	...	...	...	...	...
27564	2380	Frame with 27574	...	...	...	...	...
899j	2214	Knife Clamping Screw	...	...	...	...	...
126304	—	" Holder Body	...	...	...	...	...
126305	22214	Knife Holder, complete, Nos. 899j, 27660 and 126304	...	...	...	...	...
27323	22214	" " Guide Bar	...	...	...	...	...
27572	2380	" " " " Bracket with 27574	...	...	...	...	...
310k	22214	" " " " " " Screw Centre	...	...	...	...	...
1516j	22214	" " " " " " " " Nut	...	...	...	...	...
27573	22214	" " " " " " Spring	...	...	...	...	...
27574	22214	" " " " " " Hook	...	...	...	...	...
27659	22214	" " Stop Collar with 237k	...	...	...	...	...
237k	22214	" " " " Set Screw	...	...	...	...	...
27660		" Position Pin	...	...	...	...	...
261j	22214	" Regulating Thumb Screw	...	...	...	...	...
27662	2380	Wrench for 1508 and 1516	...	...	...	...	...
60583		Knife Grinder, Nos. 261j, 27323, 27564, 27572, 27573, 27659, 60934, two 27568, four each 310k and 1516j	...	...	...	...	...
126306		Knife Grinder, complete, Nos. 27662, 60583, 126305 and three wood screws 1" No. 10	...	...	...	...	...

# Knee Lifter

FOR 96K45 MACHINE

1507e

No.	Plate	Rock Shaft	Knee Plate	Arm	Bracket	Position	Nut
5596	2028	Bell Crank	...	...	...	...	...
62919		" " 5596 with 5601 and 62920	...	...	...	...	...
62920	2648	" " Bracket	...	...	...	...	...
178e	1324	" " " Screw	...	...	...	...	...
5601	2032	" " Hinge Pin	...	...	...	...	...
5735	2032	" " Spring	...	...	...	...	...
62921		" " complete, Nos. 5735 and 62919	...	...	...	...	...
20340	2648	Lifting Lever with 448c	...	...	...	...	...
12415	2648	" " Connecting Rod	...	...	...	...	...
12416	1316	" " " " " Joint	...	...	...	...	...
76d	1324	" " " " " Hinge Screw	...	...	...	...	...
1521e	2034	" " " " " Lock Nut	...	...	...	...	...
802d	2035	" " Hinge Screw	...	...	...	...	...
12241	1316	" " Link	...	...	...	...	...
766d	1324	" " " " Hinge Screw	...	...	...	...	...
16586	2648	" " Pin	...	...	...	...	...
448c	1324	" " " " Set Screw	...	...	...	...	...
2763	2379	Rock Shaft	...	...	...	...	...
139633		" " 2763 with 2770, 6337 and 139623	...	...	...	...	...
97502	1815	" " Bracket	...	...	...	...	...
		" " " " Screw (wood) 1" No. 10	...	...	...	...	...
2765	2379	" " Knee Arm	...	...	...	...	...
2768		" " " " 2765 with 2766 and 2767	...	...	...	...	...
2766	2379	" " " " Hub with 356c	...	...	...	...	...
356c	1324	" " " " " Set Screw	...	...	...	...	...
2767	2379	" " " " Plate with 356c	...	...	...	...	...
356c	1324	" " " " " Set Screw	...	...	...	...	...
6337	2379	" " Lifting Bracket with two 356c	...	...	...	...	...
139623	2648	" " " " Hook	...	...	...	...	...
356c	1324	" " " " " Set Screw	...	...	...	...	...
356c	1324	" " " " " Set Screw	...	...	...	...	...
2770	2379	" " Stop Dog with 356c	...	...	...	...	...
356c	1324	" " " " " Set Screw	...	...	...	...	...
93815		" " complete, Nos. 2768, 139633, two 97502 and four wood screws 1" No. 10	...	...	...	...	...
88620		Knee Lifter, complete, Nos. 76d, 766d, 802d, 1521e, 12241, 12415, 12416, 16586, 20340, 62921, 93815 and two 178e	...	...	...	...	...

# Thread Unwinder

## FOR TWO SPOOLS OF THREAD

No.	Plate								
228692	1503	Spool Pin	...	...	...	...	...	...	...
201528h	1503	" " Nut	...	...	...	...	...	...	...
82538	1503	" " Washer	...	...	...	...	...	...	...
225257	1621	" Rest with 201018c, two each 82538, 201528h and 228692	...	...	...	...	...	...	...
150203		" " Cushion (felt)	...	...	...	...	...	...	...
225388	1621	" " Rod	...	...	...	...	...	...	...
200383c	2034	" " " Set Screw	...	...	...	...	...	...	...
201018c	2034	" " Set Screw	...	...	...	...	...	...	...
202490	1621	" Stand with 200383c	...	...	...	...	...	...	...
225391	1621	Thread Guide	...	...	...	...	...	...	...
201696j	2034	" " Lock Nut	...	...	...	...	...	...	...
225326		" " Position Cup	...	...	...	...	...	...	...
225324	1621	" " " Rod with 208e and 225322	...	...	...	...	...	...	...
208e	2035	" " " Screw	...	...	...	...	...	...	...
225322		" " " Washer	...	...	...	...	...	...	...
225258	1621	<b>Thread Unwinder</b> , complete, Nos. 201696j, 202490, 225257, 225324, 225326, 225388, two each 150203, 225391 and three wood screws $\frac{7}{8}$ " No. 12	...	...	...	...	...	...	...
27739		<b>Thread Cone</b> (wood) for large cones	...	...	...	...	...	...	...
225390		" " Holder for inverted cones	...	...	...	...	...	...	...

NOTE: - Nos. 27739 and 225390 are used with, but not included in 225258.